



UNIVERSITI
MALAYSIA
KELANTAN

In conjunction with

Pecipta'22



ICU 2022

INTERNATIONAL CONFERENCE ON UMMAH

*“Strengthening Humanity Values in
Ummah Civilization of Digital Era”*

4th–5th DECEMBER 2022

UNIVERSITI MALAYSIA KELANTAN, BACHOK

HYBRID CONFERENCE

eProceedings

e ISBN 978-967-0021-48-5

In collaboration with





PROCEEDINGS

INTERNATIONAL CONFERENCE ON UMMAH (ICU) 2022

*“ Strengthening Humanity Values in Ummah Civilization
of Digital Era ”*

UNIVERSITI

MALAYSIA

PUBLISHER

Penerbit UMK,
Universiti Malaysia Kelantan, Pejabat Perpustakaan dan Pengurusan Ilmu,
Karung Berkunci 36, Pengkalan Chepa, 16100 Kota Bharu, Kelantan.
2020

KELANTAN

PROCEEDINGS
INTERNATIONAL CONFERENCE ON UMMAH (ICU) 2022

© Secretariat of ICU 2022
Faculty of Language Studies and Human Development,
Universiti Malaysia Kelantan (UMK)
Kelantan, MALAYSIA.
2022

All Right Reserved. No part of this publication may be reproduced, stored in a retrieval system or transmitted in any form, or by any means, electronic, mechanical photocopying, recording or otherwise, with the prior permission from the Faculty of Language Studies and Human Development, Universiti Malaysia Kelantan (UMK).

Publish by:
Faculty of Language Studies and Human Development,
Universiti Malaysia Kelantan
Pejabat Perpustakaan dan Pengurusan Ilmu
Karung Berkunci 36, Pengkalan Chepa,
16100 Kota Bharu,
Kelantan.
4th – 5th December 2022/ Kamarulzaman et.al.

e ISBN 978-967-0021-48-5

1. Social Sciences and Humanities
2. Digital Era Education
3. Information and Communication Technology
4. Business, Entrepreneurship and Administrative Management
5. Kamarulzaman Abdul Ghani

Editor:
Noor Hisham Md. Nawi
Zaleha Embong
Ahmed Thalal Hassan
Wan Ahmad Amir Zal Wan Ismail
Ng Siew Foen
Ahmed Abdelghany Mohammed Abdelghany
Siti Bahirah Saidi
Nawi @ Mohd Nawi Ismail
Mohd Asyraf Zulkffli

Type Setting:
Marwan Mohd Khir

CONTENT

No.	Title/ Author (s)	Page
1	'Liberal Islam' in Malaysia and Their Interpretations of Religious Texts: A Literature Review <i>Farah Umaina Najwa Ismail & Nur Saadah Hamisan@ Khair</i>	1
2	Website-Based Clinic Medical Record Information System Design (Case Study: Nurul Hayat Clinic) <i>Dira Savira & Rizqi Putri Nourma Budiarti</i>	16
3	Gamification Book and Gamified Mobile Application to Learn Basic Terminology in Information Technology <i>Siti Nurul Mahfuzah Mohamad, Mohd Azran Mohd Salleh & Siti Hidayah Abd Rahim@Rahim</i>	30
4	A Development Infographic Using Local Learning Source for Instructional Preparation of Basic Education Schools under Yala Primary Educational Service Area in the Southern Border Area <i>Nureeda Japakeeya & Nurhuda Sadama</i>	40
5	The Influences of Organizational Culture, Work Discipline, and Leadership Style on Teacher Performance at Islamic Middle Education Institutions Tikung Lamongan <i>Abdul Ghofar Farisatul Habibi & Ubaidillah Zuhdi</i>	48
6	Creative Tourism Management Model After Covid -19, Betong District, Yala Province <i>Papon Budsayamarn, Sarinya Jungjing & Ittichai Seadam</i>	54
7	An Investigation on Graduates' Written Discourse for Social Intelligence: A Discourse Analysis on Job Application Documents <i>Muhammad Nadzrin Khairuddin & Mimi Nahariah Azwani Mohamed</i>	67
8	The Effects of Work Motivation, Organizational Culture, and Work Environment on Employee Performance Through Work Discipline Mediation Variables at PT. Suma Samudra Mandiri <i>Badri Syarif & Ubaidillah Zuhdi</i>	76
9	Demographic Characteristic of Gamification in Malaysia <i>Wan Hashridz Rizal bin Wan Abu Bakar, Zuraini binti Mohamad & Nur Aulia Fahada binti Misaridin</i>	82
10	Domestic Travelers' Preferences in Selecting Transportation Mode in the Post-COVID-19 Pandemic <i>Afifah Hanim Md Pazil & Yuhanis Mohamed Noor</i>	87

No.	Title/ Author (s)	Page
11	English at Workplace: A Quantitative Report on Communication Apprehension among Malaysian Employees <i>Mohd Zulfadli Mat Husin</i>	95
12	Orientation Program of the Nutrition and Health Intervention Components to Stimulate Health Promoting School in Kediri District, East Java, Indonesia <i>Pratiwi Hariyani Putri, Ary Andini, Sa'bania Hari Raharjeng, Paramitha Viantry & Dini Setiarsih</i>	109
13	Model for Representation of People's Malay Identity Guided by Gurindam Duabelas Raja Ali Haji <i>Asrinda Amalia, Nur Azuki & Hevi Susanti</i>	124
14	Hacking Academic English Writing Course using Innovative Pedagogy <i>Nur Hafezah Hussein</i>	133
15	The Performance of Waqf Institutions via Maqasid Syariah Index (MSI) <i>Nik Noorhazila Nik Mud & Wan Hakimah Wan Ibrahim</i>	137
16	Developing Education Leaders in Managing Adaptation of Technology: Focus Group Analysis <i>Muaza Shifa Rumeli & Ahmad Aizuddin Md Rami</i>	146
17	Repair of Pancreas Beta Cell Damage in Diabetes Mellitus Through Active Compounds of Mangosteen Skin Extract <i>Novera Herdiani, Bambang Wirjatmadi, Kuntoro & Edza Aria Wikurendra</i>	155
18	Surveying and analyzing of factors related to holistic active aging preparation of working adults in Nakhon Nayok province of Thailand <i>Ormjai Taejarernwiryakul, Sirikul Thummajitsakul, Sunisa Songsaigath, Pakarang Srimee, Rattiporn Kosuwin, Pattakorn Buppan, Yuparat Odglun, Supim Wongtongtair, Piyanuch Yoadsomsuay, Pimonporn Chaovipoch, Sukalya Kritsnakriengkrai & Surasak Yooyongsatit</i>	165
19	Journalist Competence, Press Professionalism, and Social Responsibility: A Conceptual Paper <i>Eka Putra & Azman Bidin</i>	173
20	Guinea Absolute Monarchy Leaderships Nuclear Security Weapon Nations <i>Cheick Ahmed Mandian Toure, Marwan Ismail & Ali Salman</i>	184
21	The Application of Fuzzy Delphi Method in Validating Refined YouTube Evaluation Rubric <i>Foo Mei Ting & Siew Foen Ng</i>	191

No.	Title/ Author (s)	Page
22	Sustainability-Driven Entrepreneurial Intention Among Students in Malaysian Community Colleges: Some Initial Observations <i>Norsalwati Mohd Razalli, Nurul Nuha Harun & Zainal Ariffin Ahmad</i>	213
23	Information Technology Governance Analysis Using Cobit 5 in Pakis Village Surabaya City <i>Fajar Annas Susanto, Trian Rahma Sari & Ragil Puji Rahayu</i>	226
24	Study of Social Life in The Culture of Malay Petalangan in The Digital Era <i>Hevi Susanti, Ali Salman, Asrinda Amalia & Edo Arribe</i>	232
25	The Success of Community Leadership in Reducing Poverty: A Focus Group Analysis <i>Ahmad Aizuddin Md Rami & Mohd Faiq Abd Aziz</i>	246
26	The Development of E-comic to Increase the Awareness of Obesity Among Children <i>Methusha a/p Nelia @ Athaven & Muhammad Helmy Emran</i>	253
27	Implementation of Interactive Map Visualization in Crime Detection <i>Muhammad Asyraf Zolkefli & Nurul Fathihin Mohd Noor Shah</i>	259
28	Implementation Speech Recognition in Expiry Alert System <i>Muhammad Alif Amiry bin Abdul Wahab & Nurul Fathihin Mohd Noor Shah</i>	271
29	IT Adoption Model for Smart School: A Systematic Literature Review <i>Endang Sulistiyani, Nur Shabrina Meutia & Rita Sari</i>	280
30	Effect of E-Leadership on Employees Performance in a Work from Home Setup during Crisis <i>Juliza Adira binti Mohd@Ariffin & Ahmad Aizuddin bin Md Rami</i>	291
31	Managing Governance and Development in A Multi-Ethnic Society: A Thematic Review <i>Khairol Anuar Kamri & Aizathul Hani Abd Hamid</i>	298
32	Performance Study of Virtualized Firewalls in Small Office Home Office Environment <i>Muhammad Iqhwani Bin Adnan, Khadijah Wan Mohd Ghazali & Nurul Azma Zakaria</i>	308
33	Muhyiddin Yassin's Effective Public Speaking Style and Its Effect on Leadership Brand <i>Azman Bidin, Azran Fitri & Ali Salman</i>	315

No.	Title/ Author (s)	Page
34	Techniques to Identify The Themes in Qualitative Data Among The Hysteria Malay Students in Secondary School <i>Nagarubini Paramasivam</i>	328
35	Study on The Consumer Attitudes Towards Digital Shopping During the Pandemic in Johor Bahru <i>Norfazlirda Hairani, Zuhayra Khayrin Zaini & Nik Syuhailah Nik Hussin</i>	335
36	Revolution 4.0: Re-understanding Humanity in the Era of Artificial Intelligence through an Analysis of Seyyed Hossein Nasr's Philosophy of Humanity <i>Musa Yusuf Owoyemi</i>	343
37	The Relationship Between Physical Activities and Sleeping Quality During COVID-19 Among Students in Kolej Komuniti Pasir Mas <i>Aisha Azman, Azman Bidin & Maziha Mustafa</i>	352
38	The Role of Attitude in Explaining Gamification Adoption Among Academician in Malaysia <i>Zuraini binti Mohamad, Nur Aulia Fahada binti Misaridin & Wan Hashridz Rizal bin Wan Abu Bakar</i>	361
39	The Effects of Transformational Leadership Style and Organizational Commitment on Member Performance (Case Study: The Nahdlatul Ulama Women's Student Association (IPPNU) Semabung Village) <i>Tika Indriani & Ubaidillah Zuhdi</i>	365
40	Western Corporate Communication Model for Local Entrepreneurs <i>Asma Azman, Azman Bidin & Maziha Mustafa</i>	372
41	Religious Motivations for Everyday Life from a Hadith Context and Potential Wonders <i>Mohd Arif Nazri, Nur Farhah Zainan Nazri, Mohammad Ikram Mohd Nor & Faris Izwan Nordin</i>	380
42	Systematic Literature Review: Communication Anxiety in Students <i>Nur Fitriyana & Yohan Kurniawan</i>	392
43	Assessment of The Role of Safety Management Attitudes Towards Safety Compliance Among Construction Contractors <i>Nik Fadhillah Nik Him, Noor Aina Amirah, Siti Khatijah Yasin & Nurhazilah Mamat</i>	399
44	Overview of Employee Voice on Expeditionary Employees <i>Didik Widianoro, Yanwar Arief, Irfani Rizal & Nur Fitriyana</i>	406

No.	Title/ Author (s)	Page
45	Gig Economy and Workers in Logistic Industry on Malaysia's Perspective <i>Izatul Husna Zakaria, Siti Fatimah Mohd Nasaruddin, Mohd Zulfabli bin Hasan, Mawaddah binti Mohamad, Nur'Jila Mohammad & Siti Hawa binti Harith</i>	410
46	Aspirations for Doctoral Study Among Academic Staff <i>Nazatul Syima Mohd Nasir, Khairul Hisyam Baharuddin & Fairuz A'dilah Rusdi</i>	415
47	The Influence of Forgiveness Techniques on Family Conflict in Students <i>Puti Febrina Niko & Yohan Kurniawan</i>	421
48	Self-Reliance, Simple Living, and Happiness in the Man Who Quit Money <i>Khairul Hisyam Baharuddin, Nazatul Syima Mohd Nasir & Fairuz A'dilah Rusdi</i>	425
49	Teori Ijtihad Maqasidi dalam Pengeluaran Fatwa: Analisis Al-Dharuriyyat Al-Khams <i>Muhammad Mustaqim Bin Roslan & Mohd Aliff Haiqal Bin Mhd Suhaimi</i>	431
50	Pendefinisian Persediaan Rapi Tenaga Pengajar dalam Proses Pembelajaran dan Pengajaran di Institusi Pengajian Tinggi <i>Najjah Salwa Abd Razak, Norashikin Sahol Hamid, Nur Syafiqah Mohd Yazib & Norshima Zainal Shah</i>	442
51	Kerelevanan Penggunaan Tulisan Jawi Dalam Buku Teks Pendidikan Islam Sekolah Rendah <i>Ahmad Naqiuddin bin Husin & Mohd Isa bin Hamzah</i>	453
52	Aktiviti Kawasan Rukun Tetangga Sebagai Tapak Integrasi <i>Lina Mastura Jusoh & Zaleha Embong</i>	467
53	Isu-isu Kesejahteraan Akidah dalam Kalangan Kanak-Kanak Mualaf di Malaysia <i>Nur Shafiqah Badlihisam & Redwan Yasin</i>	477
54	Penglibatan Ibu Bapa di dalam Kebolehan Membaca Al-Quran Anak di Rumah <i>Karim bin Wahab & Mohd Isa bin Hamzah</i>	491
55	Faktor Pengaruh Bahasa Inggeris dalam Pembelajaran Bahasa Mandarin Sebagai Bahasa Asing <i>Nur Farrah Atiqah Amran & Muhammad Nazirul Mohd Noor</i>	501

No.	Title/ Author (s)	Page
56	Potensi Caravanserai Sebagai Destinasi Pelancongan Warisan Budaya <i>Aina Zafirah Samsudin & Roziah Sidik @ Mat Sidek</i>	509
57	Zina (Soal Jawab & Pertimbangan Akal): Analisis Ayat 32 Surah Al-Isra' & Hadis Abu Umamah Al-Bahili <i>Mohd Zulkifli Bin Baharun & Mohd Isa Hamzah</i>	520
58	Faktor Dominan dalam Mempengaruhi Kecenderungan Sokongan Nelayan dalam PRU-15 <i>Norria Zakaria, Mohamad Zaki Ahmad & Malike Brahim</i>	529
59	Dasar dan Program Bantuan Kerajaan Kepada Masyarakat Nelayan: Keperluan atau Keprihatinan? <i>Malike Brahim, Yusuf Pon & Musliza Mohamad</i>	537
60	Kepincangan Trend Pakaian Cara Islam dalam Kalangan Wanita Islam <i>Masroha bt Sepian & Nur Azuki Yusuff</i>	551
61	Haji Senik Seligi, 1818-1929: Sumbangannya Terhadap Pengajian Al-Quran Di Kelantan <i>Mohd Fadli Ghani</i>	563
62	Hidroterapi Wudhu' Sebagai Rawatan Alternatif Bagi Manfaat Kesihatan Emosi dan Intelek <i>Ezzah binti Mohd Adam & Latifah binti Abd Majid</i>	584
63	Pengetahuan Guru dan Cabaran dalam Menintegrasikan Teknologi Maklumat dan Komunikasi (TMK) dalam Pengajaran dan Pembelajaran Pendidikan Islam: Sebuah Tinjauan Literatur <i>Ahmad Fikrul Amin Shanusi & Mohd. Isa Hamzah</i>	592
64	Memperkasa Industri Pelancongan dalam Masyarakat Nelayan di Malaysia <i>Mohamad Zaki Ahmad, Norria Zakaria & Mohd Rushdi Idrus</i>	606
65	Kemelut Pendidikan Kanak-Kanak Rohingya: Peranan dan Cabaran Pusat Pembelajaran Alternatif di Pulau Pinang <i>Aida Zahirah Samsudin & Napisah Karimah Ismail</i>	617
66	Muzik Sebagai Terapi Masalah Kesihatan Mental: Suatu Penelitian Terhadap Sumbangan Sarjana Islam Abad Pertengahan <i>Siti Nur Adilah Awang, Ermy Azziaty Rozali & Roziah Sidik @ Mat Sidek</i>	627
67	Keperluan Keterangkuman Digital dalam Pemerkasaan Usahawan B40 di Selangor <i>Faradillah Iqmar Omar & Nur Hafidhzah Nor Hasim</i>	638

No.	Title/ Author (s)	Page
68	Penerapan Nilai-nilai Pendidikan Islam dalam Pemantapan Keperibadian Akhlak Pelajar <i>Nurul Ilmuni Hayati Che Aziz & Hafizhah Zulkifli</i>	647
69	Isu dan Cabaran Pengajaran Iqra' Guru Pendidikan Islam Pendidikan Khas Masalah Pendengaran <i>Hifzan Mat Hussin & Kamarulzaman Abdul Ghani</i>	663
70	Pendekatan Pemikiran Metakognitif Dapat Meningkatkan Pemeliharaan dan Pemuliharaan Alam Sekitar di Kalangan Pelajar Sekolah Rendah <i>Fatimah Ahmad, Mohd Hisyam Abdul Rahim, Azizul Azra Abdul Razak, Aminah Yusoff & Zaidatul Nadra Zainon</i>	675
71	Keberkesanan Pra Ujian Terhadap Pendidikan Tahfiz di Institusi Pengajian Pondok <i>Wan Zuriaty Ismail & Nur Azuki Yusuff</i>	683
72	Kepentingan Ihsan dalam Pembentukan Afektif Mahasiswa <i>Nur Syazwani Othman, Mahfuzah Mohammed Zabidi & Norhapizah Mohd Burhan</i>	693
73	Adakah Sama Atau Berbeza? Satu Perkongsian Penggunaan Dialek Melayu Kelantan dan Dialek Melayu Patani dalam Kalangan Pelajar Jurusan Bahasa Melayu di Universiti Yala Rajabhat, Thailand dalam Kursus Pengacaraan Majlis Tempatan <i>Khuzaiton Zakaria & Nurul Huda Sa'dama</i>	704
74	Konsep Penerapan Nilai, Sahsiah dan Perpaduan dalam Program Sahsiah Unggul Murid (SUMUR) di Sekolah Menengah Kebangsaan <i>Mohd Shaleh Mislan, Mohd Isa Hamzah & Ab Halim Tamuri</i>	718
75	Kesedaran Keselamatan Siber Semasa Pandemik COVID-19 <i>Fatimah Rahmat, Nurul Shakirah Mohd Zawawi & Siti Rohani Sukaimi</i>	729
76	Konstruksi Falsafah Sains Islam Menerusi Ibnu Taymiyyah: Kerangka Teori Hubungan Akal dengan Wahyu dan Sebab-Akibat Sebagai Contoh <i>Muhammad Asrie bin Sobri, Muhammad Fashan bin Ahmad Ziadi & Nik Md Saiful Aziz Nik Abdullah</i>	738
77	Stres Dalam Kalangan Pelajar Semasa Pandemik Covid-19: Pengaruh Faktor Emosi Dan Pengurusan Kewangan <i>Low Kah Choon & Nor Syamila Mohamed</i>	752
78	Mat Kilau: Kebangkitan Pahlawan (2022) Sebuah Filem Cerminan Ummah <i>Fatimah Muhd Shukri, Nur Asfarina Ab Aziz & Mohd Saipuddin Suliman</i>	760

No.	Title/ Author (s)	Page
79	Pengaruh Media Komunikasi Terhadap Perkembangan Bahasa Malaysia Pelajar Penutur Dialek Kelantan <i>Nuradlin Syafini, Zaleha Embong & Azman Bidin</i>	771
80	Pelaksanaan Tasmik di Sekolah Rendah Pasca PdPR dalam Kalangan Guru Pendidikan Islam Daerah Johor Bahru <i>Mohd Syafiq Azami bin Mohd. Helmi & Mohd. Isa bin Hamzah</i>	784
81	Pembentukan Pemimpin Masa Depan Melalui Program Kepimpinan: Kajian Kes Parlimen Belia Malaysia <i>Nasrul Hakim Bin Salleh, Marwan Bin Ismail & Noor Hisyam Bin Md Nawi</i>	794
82	Pembudayaan Inovasi Pengajaran Guru Pendidikan Islam dari Pemikiran Ibnu Khaldun <i>Siti Hazlini Binti Haris & Norhisham Bin Muhamad</i>	801
83	Pemikiran dan Perjuangan Ebit Irawan bin Ibrahim Lew dalam Dakwah Golongan Asnaf di Malaysia <i>Kartina Sari Abd Karim & Muhammad Azizan Sabjan</i>	810
84	Penerimaan Pelajar Terhadap Aplikasi Google Classroom dalam Mata Pelajaran Pendidikan Islam <i>Mardhiatul Munirah Ramli & Mohd. Isa Hamzah</i>	824
85	Pengujian Modul Sensor menggunakan Multimeter bagi membina Jadual Kebenaran dan Pseudokod <i>Sheilani Binti Shaari & Nik Nor Hishamuddin Bin Nik Mustapha</i>	833
86	Penilaian Terhadap Garis Panduan Bagi Emansipasi Wanita Menurut Ulama Melayu Abad ke-20 <i>Nor Aniza Azeri & Nur Saadah Hamisan@ Khair</i>	844
87	Peti Surat IOT Menggunakan ESP32 <i>Nur Filzah binti Mohd Fauzey & Aqil Afsar bin Mohd Fozan</i>	856
88	Sejarah Perkembangan Al-Quran Barille di Malaysia <i>Anisah Razali, Noornajihan Ja'afar & Mohd Nur Adzam Rasdi</i>	865
89	Tuan Guru Haji Ahmad Fuad Bin Hassan: Tokoh Politik Islam Sebelum Merdeka <i>Mohd Fadli Ghani</i>	875
90	Pengurusan Masyarakat Kepelbagaian dalam Kawasan Rukun Tetangga di Malaysia: Satu Analisis <i>Zaleha Embong</i>	889

No.	Title/ Author (s)	Page
91	Beberapa Elemen Terapi Tasawwuf Berdasarkan Doa Nabi Ibrahim AS <i>Farah Mohd Ferdaus, Hamdi Ishak & Mohd Manawi Mohd Akib</i>	899
92	Faktor Pendorong Kepada Minat Menyertai Badan Beruniform Bomba, PISPA Berbanding RELASIS di Politeknik Nilai <i>Norfazila Binti Ahmad</i>	909
93	Pengaruh Media Massa dan Keperluan ICT dalam Pengurusan Aktiviti Nelayan di Malaysia <i>Mohd Rushdi Idrus, Malike Brahim & Yusuf Pon</i>	915
94	Memahami Konsep Kedaulatan Watan dalam Kalangan Keluarga Malaysia <i>Siti Khatijah Yasin, Fadzli Adam, Mohd Ridhuan Tee Abdullah, Nik Fadhilah Nik Him & Nurhazilah Mamat</i>	926
95	Pemikiran Dato' Perdana Nik Mahmud Tentang Tanggungjawab Politik Orang Islam Dalam Karyanya, Penyuluh Ketinggian <i>Mohd Fadli Ghani, Badlihisam Mohd Nasir & Abdul Hafiz Abdullah</i>	935
96	Pemeriksaan Religiositi dalam Kalangan Muallaf di Darul Ukhuwah Johor Bahru <i>Ahmad Zaki Bin Mohamad Malom, Intan Farhana Binti Saparudin, Shakila Binti Ahmad & Mustapahayuddin Bin Abdul Khalim</i>	950
97	Penterjemahan Frasa Kerja Melayu-Arab Menggunakan Google Translate dan Terjemahan Manusia: Satu Kajian Perbandingan Menurut Aspek Masa <i>Mohd Ikhwan bin Abdullah & Raja Nur Hanisah binti Raja Sulaiman</i>	960
98	Strategi Dalam Memperkasakan Pedagogi Terbeza Dalam Kalangan Guru Pendidikan Islam <i>Muhammad Amirul Syazwan bin Borhanordin & Isa bin Hamzah</i>	973
99	Penerimaan Pelajar Tahfiz Terhadap Program Latihan Kemahiran di Kolej Komuniti <i>Mohd Rashidi Omar, Siti Nasuha Singki & Basuriah Yunus</i>	985
100	Pelaksanaan Taksonomi Fikir-Zikir (FiZi) Di Sekolah Terpilih Yayasan Islam Kelantan (YIK) <i>Noor Hisham Md Nawi</i>	998
101	Automatic Standardization of Arabic Dialects for Machine Translation <i>Abidrabbo Alnassan</i>	1013
102	Emotional Intelligence and Academic Achievement among Arab Secondary School Students at Some Arab School in Malaysia <i>Chafai Yasmine, Siti Rafiah Abd. Hamid & Mohd Burhan Bin Ibrahim</i>	1026

No.	Title/ Author (s)	Page
103	Students' Perception of Online Role Play Activity in Arabic Learning During COVID-19 Pandemic <i>Muhamad Hilmy Abdul Wahab & Arifin Mamat</i>	1033
104	Students' Need Analysis for i-Kalam Application in Learning Arabic Speaking Skill <i>Alif Fahmi Bin Abdullah, Taufik Bin Ismail, Muhammad Sabri Bin Sahrir & Mohd Izzat Bin Mohd Abd Shukur</i>	1044
105	أسباب هلاك الوقف وطرق حمايته " الأوقاف الليبية أمودجا" عبد العزيز ممد الشيبان, عتيق الله عبد الله & ثري أحمد د	1055
106	الإيحاء الدلالي والتربية الاستقلالية وأثرهما على الفرد والمجتمع والمدنية والحارة في ضوء القرآن الكريم وعلم النفس والاجتماع: دراسة تحليلية تطبيقية محمد بوزيرة & عبد العالي باي زكوب	1070
107	القيم الإسلامية وأثرها في بناء الفرد والمجتمع عبد العزيز أبوبكر عفظ	1091
108	تطبيقات الذكاء الاصطناعي في اللغة العربية _ معالجة اللغة نحو يا و صرفيا أحمد العثمان & حكيم زينل	1102
109	تفعيل دور الجامعات في تعليم اللغة العربية عبر وسائل التواصل الاجتماعي عمر بن محمد دين, عبدالغني بن محمد دين & رشدي طاهر	1117
110	Pelaksanaan Kem Bestari Solat dalam Kalangan Guru Pendidikan Islam Sekolah Murid Orang Asli <i>Mohamad Zahier Zamahshari & Mohd Isa Hamzah</i>	1136
111	Kajian Cadangan Program Baharu di Kolej Komuniti Lipis Mengikut Pandangan Pelajar Sekolah Menengah Harian di Daerah Lipis <i>Nurul Farhana Mokhtar & Shah Rulbani Zakaria</i>	1150
112	Study on the Perceptions and Health Policies Related to the Implementation, Protection, and Fulfillment of the Rights of Persons with Disabilities in Indonesia <i>Ulfa Ulinuha, Atik Qurrota A'Yunin Al Isyrofî & Mursyidul Ibad</i>	1159
113	Isu dan Cabaran Kerja Masyarakat Kerinci: Kajian Kes di Lembah Pantai Kuala Lumpur <i>Sharmin Kutty Sivaraman, Khairul Izzat Amirudin, Adib Zakwan Al Qayyum & Sutharssan Nadarajan</i>	1168

No.	Title/ Author (s)	Page
114	Ontology of Social Networking Sites Related to Ibn Khaldun's Thoughts: Evaluation Approaches <i>Mohamad Hafizuddin Mohamed Najid, Zahidah Zulkifli, Roslina Othman, Rohaiza Rokis & Ashraf Ali Salahuddin</i>	1182
115	Teaching Arabic Grammar Using Tree View Representation <i>Ahmed Abdelghany Mohammed & Ahmad Abdul Rahman</i>	1197

FOREWORD

Assalamualaikum warahmatullahi wabarakatuh.

Peace be upon you.

I am especially honoured to cordially welcome all of you, most particularly the keynote speakers to the International Conference on Ummah 2022: Strengthening Humanity Values in Ummah Civilization of Digital Era (ICU 2022). We are also ecstatic and fortunate to have the presence of the local and international participants who have accepted our warm invitation to be part of ICU 2022.

As we come together in this hybrid conference with the theme of “Strengthening Human Values”, I would like to invite everyone to share their thoughts and ideas on what major considerations should be taken into account as we move forward in re-establishing human values in society and enhancing ideas for global harmony. Human values are increasingly being used as a concept in a wide range of fields namely social sciences and humanities, digital era education, information and communication technology and business, entrepreneurship and administrative management, which are all covered in ICU 2022. Without human values, human society might not be significantly sustainable. Therefore, it is important to discuss the issue and raise awareness to strengthen human values in contemporary culture.

ICU 2022 is organized in cooperation with five other institutions which are Universitas Nadhlatul Ulama Surabaya (UNUSA), Princess of Naradhiwas University (PNU) Thailand, Universiti Tun Hussein Onn Malaysia (UTHM), and Persatuan Intelektual Muslim Malaysia (PIMM). My most profound thanks to the Vice-Chancellor of Universiti Malaysia Kelantan, the Honourable Prof. Dato’ Dr. Razli Che Razak, and the Committee of ICU 2022 for their time, hard work and relentless support in making this Conference a reality. My very best wishes for an effective, productive and successful Conference.

Thank you.

ASSOC. PROF. DR. KAMARULZAMAN ABDUL BIN GHANI
DIRECTOR OF ICU 2022

‘Liberal Islam’ in Malaysia and Their Interpretations of Religious Texts: A Literature Review

Farah Umaina Najwa Ismail
Universiti Sains Islam Malaysia
farahnajwa@raudah.usim.edu.my

Nur Saadah Hamisan@ Khair
Universiti Sains Islam Malaysia
saadahkhair@usim.edu.my

ABSTRACT

Islam has been viewed as an oppressive and stagnant religion in many aspects by ‘Liberal Islam’. It is a group that refers to imply a logical mind in their arguments and fights for the right to freedom that Islam previously believed to be denied. The emergence of ‘Liberal Islam’ in Malaysia has created many conflicts among Muslims. The debate is whether to apply logical thinking instead of relying upon Islamic legal sources due to the claim that Islam promoted injustice and discrimination against human rights. Therefore, the study is concerned to scrutinize several objectives. First, to discover previous studies on the ‘Liberal Islam’ philosophically and historically; Second, to analyze the approaches applied by the ‘Liberal Islam’ in the interpretation of the religious texts. A qualitative study based on a literature review through documents, journals, and books will be applied to identify the previous studies that have been conducted on issues related to the ‘Liberal Islam’. The study found that most of the previous studies agree that the approach taken by ‘Liberal Islam’ to practice Islam clearly deviated from sharia. The ideology of liberalism clearly contradicts to the perspectives of the Quran and Hadith, and the impact from the liberation idea is convulsive particularly to the Muslim communities.

Keywords: Approach; Hadith; Ideology; Interpretation; Liberal Islam; Quran

ABSTRAK

Islam dilihat sebagai agama yang menindas dan jumud dalam pelbagai aspek dari padangan ‘Islam Liberal’. Ia merupakan gerakan yang menggunakan pemikiran logik dalam hujah mereka dan memperjuangkan hak kebebasan yang sebelum ini dipercayai dinafikan oleh Islam. Kemunculan ‘Islam Liberal’ di Malaysia telah menimbulkan banyak konflik dalam kalangan umat Islam. Perdebatan oleh ‘Islam Liberal’ menggunakan pemikiran logik dan bukannya bergantung kepada sumber perundangan Islam adalah kerana dakwaan bahawa Islam melakukan ketidakadilan dan diskriminasi terhadap hak asasi manusia. Oleh itu, kajian ini bertujuan untuk meneliti beberapa objektif. Pertama, untuk meninjau kajian yang lepas berkaitan ‘Islam Liberal’ secara falsafah dan sejarah; Kedua, menganalisis pendekatan yang diterapkan oleh ‘Islam Liberal’ dalam pentafsiran teks agama. Kajian kualitatif berdasarkan tinjauan literatur melalui dokumen, jurnal, dan buku akan diaplikasikan untuk mengenal pasti kajian-kajian lepas yang telah dijalankan mengenai isu-isu berkaitan ‘Islam Liberal’. Kajian mendapati kebanyakan kajian lepas bersetuju bahawa pendekatan yang diambil oleh ‘Islam Liberal’ untuk mengamalkan Islam jelas menyimpang daripada syariah. Ideologi liberalisme juga jelas bercanggah dengan perspektif Al-Quran dan Hadis, dan kesan daripada idea pembebasan itu amat merisaukan khususnya kepada masyarakat Islam.

Kata kunci: Hadith; Islam Liberal; Pemikiran; Pendekatan; Tafsiran; Quran

INTRODUCTION

Islam has been regarded as a religion that stifles, stagnates, and limits progress from a liberal standpoint. Islamic law, which is considered to be unlawful, unjust, repressive, and unfit for implementation in a multiracial and multireligious society, has even been accused of being utilised as a means of intimidation against the community (Zainuddin, 2019). The study by Amin & Syarifah (2021) found that the 'Liberal Islam' movement calls for the reinterpretation of the Quran and Hadith in light of modern times. They contend that the Quran must be reinterpreted without reference to earlier scholars' views in order to be in harmony with the contemporary era of modernisation. The interpretations of earlier scholars have been far outpaced and are no longer relevant. This claim has demonstrated the need for society to treat the topic of 'Liberal Islam' seriously. A research issue about the threat, strategy, and interpretation of 'Liberals' has been raised by looking at the problem at issue.

Therefore, the purpose of this article is to discover previous study on the 'Liberal Islam' philosophically and historically. In addition, this study aims to analyze the approaches applied by 'Liberal Islam' in the interpretation of the religious text. Content analysis based on a literature review through documents, journals, and books will be applied to identify the previous studies that have been conducted on issues related to the 'Liberal Islam'.

THE EMERGENCE OF LIBERALISM IN MALAYSIA

The liberal movement began in Europe in the late 18th or early 19th centuries. It was founded by John Locke, Immanuel Kant, Adam Smith, and J.S. Mill, among others. They advocated for individual liberty in numerous spheres of life, including religious freedom, freedom of expression, freedom of the press, ethnic and gender equality, democratic trade, human rights, women's and minority group rights, and citizen rights (Nasir & Omar, 2020).

Historically, past studies have concluded that the formation of ideologies such as liberalism in Malaysia began with the spread of modern thought through overseas study in European countries (Mohammad, 2006; M. F. Ismail et al., 2012). As a direct consequence of this, the educational system in the West offered them a platform on which the issue of freedom and human rights could be vigorously debated. The students' familiarity with the principles and theory of democracy, as applied in European and American governance, was made possible as a result of their exposure to Western epistemology, philosophy, and politics. As a result, the students came away with the impression that democracy is one of the most superior political concepts. This appears to be the reason why the Malays chose to follow the lead of the West on democracy, incorporating aspects of other ideologies such as nationalism and liberalism into the political and social challenges of Malaysia.

The history of liberalism in Malaysia is inextricably linked to several causes that contributed to these ideologies gaining increased attention and support from certain groups of Malaysian Muslims. In general, two major causes have aided in the growth of liberalism beliefs. First, the global advancement of technology as communication tools such as mass media and the internet provides access to a wide variety of foreign philosophies and beliefs (Ali & Ismail, 2017). In brief, the significant influence of globalisation resulted in the establishment of several notable persons and Muslim non-governmental organisations in Malaysia that were influenced by the liberalism ideology originating in the West. Liberalism has been extolled as the supreme kind of philosophy capable of addressing the urgent demand for human rights in the modern day (Nur Zainatul Nadra Zainol, 2018).

The second aspect that contributed to the development of liberalism in Malaysia is the existence of numerous international organisations dedicated to raising funds and donations to promote the spread of the ideology in Malaysia. The NGOs supported by the Western foundations, such as the Asia Foundation, the Ford Foundation, and the Konhraf Adenour Foundation, were obligated to espouse liberal ideas (Mohammad, 2006; Jaeh & Ismail, 2020). Haji Aminuddin Yahaya mentioned in an interview that a total of over US \$700,000, or nearly RM3,000,000, has been channelled to selected NGOs to advance specific objectives like human rights, national policy, and research (Ainul Illia, 2021).

LIBERALISM AND ITS THREATS

Undeniably, liberalism which emphasizes on freedom of thinking comes with impacts to Muslim communities. The impacts are not only negatively affected the religion and believers, but comes with threats which can be regarded as something unpleasant or violent that will happen, especially if a particular action or order is not followed (Cambridge Dictionary, 2022). Therefore, the ideology of liberalism has its own threat in which should be taken seriously by all parties.

Homosexual Marriage

Marriage is a legally and socially sanctioned partnership between two people, which is between a man and a woman, defined by laws, norms, customs, beliefs, and attitudes that define the spouses' rights and responsibilities and confer status on their children (Britannica, 2021). However, observing the ideology of 'Liberal Islam', under the name of human rights, the 'Liberal Islam' movement does support homosexual marriage (Wan Ismail Wan Dagang et al., 2015; Zuhri, 2016; Rohmawati, 2016; Norarfan Zainal, 2019). Among the reason of the liberalism movement in supporting homosexual marriage is to strengthen freedom of religion and belief between the partner (Equality Network, 2013). Thus, freedom of religion and belief means respecting the rights of those bodies that want to conduct same-sex marriages too. For example, in Scotland, 68% of people believe religious organisations should have the right to conduct same-sex marriages if they want to.

On the other side of coin, the supporters of homosexual marriage believe the law should treat all people equally by allowing same-sex marriage (Jordan, 2013). Hence, one's civil rights should not depend upon one's ethnicity, gender, or sexual orientation. To treat marriage as an exclusively heterosexual institution, however, is – practically speaking – to deny some citizens a particular civil right, and to do so based on sexual orientation (Mohammad, 2006). Therefore, the legal right to marry should be extended to same-sex couples as a matter of simple fairness. Nonetheless, there have been no reported examples of homosexual marriage in Malaysia as of yet.

However, there was a case as what happened to Ariff Alfian Rosli when he get married to his partner name Jonathan in Dublin, Ireland (Goh, 2014). Ariff is Malaysian and he claimed that he is still a Muslim and has never apostate (MStar, 2011). Besides, another homosexual marriage of a Muslim man name Jahed Choudhury was held in the United Kingdom (BBC News, 2017). Jahed believes that he can be both gay and Muslim at the same time. What make it worst, there are 30 countries that supported homosexual marriage under the name of freedom and human rights (Pew Research Center, 2019). The cases of homosexual marriage also are increasing among Muslims, which not only pose a threat to other Muslims, but has affected the bad image of Islam.

Furthermore, another issue on freedom of marriage argued by 'Liberal Islam' is inter-religion marriage (Muhammad Atiullah & Mohd Nor, 2009). It refers to a marriage between

spouses from different religions including Islam. The 'Liberal Islam' permits inter-religion marriages based on three arguments. Firstly, they brought upon the pluralism concept where the *sunnatullah* cannot be avoided. Therefore, inter-religion marriages can be a medium for Muslim and other believers of religion to get to know each other. Secondly, they mentioned that the main purpose of getting married between two individuals from different religions is to build love between individuals from various faiths through toleration and understanding. Last but not least, it is to free the Islam religion from its restraints, and it will help those believers who want an inter-religion marriage get it slowly through this method (Armayanto & Ulfa, 2013). From these arguments, it has shown that the Muslim liberalists would continuously come up with arguments just to let the freedom of doing things even though it is needed for them to go against the natural laws which have been stated in the Quran, Hadith, *Ijmā'* and other genuine sources.

Religious Pluralism

The term 'religious freedom' has two distinct meanings. To begin, religious liberalism is an ideology that contradicts with Islamic teachings, namely, that the Quran and Hadith should be understood via logic; and those religious beliefs should be accepted solely based on their intellectual compatibility (Mohammad, 2006). Whereas, the second definition states that religion has no obligations (Ridzuan et al., 2019). The second definition regarding in religion has no obligation do have a connection with religious pluralism. Religious pluralism is extremely hazardous since it is an ideological attack that seeks to change one's ideas by attacking one's reasoning. Freedom of religion is the issue that is most fought for by those who understand pluralism (Mohamad et al., 2021).

In general, Islam is the official religion of the Malaysian Federation. However, other religions can be practiced securely and harmoniously in Malaysia, but this does not imply that Islam is susceptible to being affected by Western ideologies, particularly liberalism. Article 153 of the Constitution emphasises Malaysia's value as a diverse country, outlining the rights and obligations of religious communities coexisting peacefully (Malaysian Federal Constitutions, 1957). As it stands today, religious freedom is a contentious human right from the liberalism standpoint.

Religious pluralism is defined as "respect for the diversity of others". Religion freedom encompasses all religions operating under the legal framework of a particular region. As a result, two distinct notions of religious pluralism exist. While the first term refers to religious pluralism, another view regards all religions as manifestations of the same single truth (Awang et al., 2011; Ridzuan et al., 2019; Wan Ismail Wan Dagang et al., 2015). Additionally, liberals advocate a broad definition of religious pluralism, which is defined as the acceptance of diverse religions. They argue that no single and exclusive religion contains truth, or that different religions contain truth and true values (Norarfan Zainal, 2019).

Notably, religious liberty can pose a threat to Muslims in particular. It will be harmful if the liberal movement interprets the Quran only through the lens of their rational thinking. For example, the 'Liberal Islam' movement interprets Surah al-Baqarah verse 256 as "there is no compulsion in religion" with understanding and belief that Muslims may leave their faith anytime because of the word "no compulsion" (Ismail & Mat, 2016; Rosni Wazir et al., 2018; Abdullah, 2014). As a result of the circumstances surrounding the case of Lina Joy, the 'Liberal Islam' movement contended that Muslims should be permitted to apostatize from their religion (Islam) without going through the legal procedure or being exposed to the Syariah Court's judgement, because as stated by Van Engeland (2014): "The Lina Joy case clearly illustrates how having a dual system of courts can limit the freedom of religion". However, there is a clear

difference between the freedom of religion and the prohibition of changing religion (S. Z. Ismail & Mat, 2016).

On the other hand, it can be seen that the main problems of religious freedom are the issue of apostasy which is connected with the issues of blasphemy, heresy, and hypocrisy (Badri, 2018). It became worst situation when the issue of apostasy is also being supported by a Malaysian NGO such as G25. It is a group of powerful Malay individuals who, as civil society organisations, play a positive role as the voice of moderation on issues relating to religion. G25 asserts that there is no constitutionally permitted ground to prohibit the mere profession of one's religion; the right to profess a religion of one's choice is a right guaranteed by Art 11 of the Federal Constitution (Mutalib & Sulaiman, 2017).

Thus, G25 believes that apostasy has a different connotation which they perceived from the Islamic texts. Since no one can be coerced to believe in God, in Islam, it follows that no one can be coerced to remain in Islam. Therefore, a Muslim may decide to abandon their faith in Islam. It is not a right in and of itself; rather, it is an instance of an individual exercising their choice. Leaving Islam is something that should be avoided at all costs. If a Muslim wants to exercise that choice, they should be convinced to stay within the fold of Islam. Nevertheless, if somebody is adamant about abandoning Islam, then that decision is solely between him and God. The Quran does not prescribe any form of physical punishment in any of its verses (G25, n.d.).

Deconstruction of Islamic Law

There are figures in Islam who fight for freedom of thought and express their opinions on Islamic topics in order to keep politics and religion separate. Ali Abd al-Raziq, who declared that Islamic law is not fixed but is subject to change according to time and place, is one of those who has been vocal in defending the ideology of free thought (Sharkey, 2010). In addition, Qasim Amin advocated for the freedom of thought to be allowed to question the views of prominent scholars (Sonneveld, 2017). It is risky for some groups motivated by 'Liberal Islam', for example, to fight to open the door to *ijtihad* without any constraints. They believed that freedom of thought is a component of human rights. However, Sulong (2016) and Harris (2009) on the other hand, argued that while Islam fosters freedom of thought and expression, it also teaches its adherents to respect the ideas of scholars who have mastered a competence in the field.

Ijtihad can be translated literally as the highest amount of effort exerted in performing a task (Abdul Karim Zaidan, 1976). The phrase "utmost effort" refers to exerting maximum and complete energy. As a result, it is not called *ijtihad* if there is no hardship or maximum effort involved. Thus, *ijtihad* is not used to carry a seed, but rather a rock, because carrying rocks requires a great deal of effort (Abdul Rahim & Abdul Rahim, 2014). In other words, *ijtihad* is an Arabic word that refers to making the greatest possible effort in a situation that calls for it (Kamaruddin et al., 2012).

In general, the 'Liberal Islam' movement calls for the reinterpretation of the Quran and Hadith in light of modern times (Amin & Syarifah, 2021). Furthermore, in order to be in line with the current period of modernization, the Quran must be reinterpreted without regard for previous scholars' interpretations. Earlier scholars' interpretations have fallen far behind and are no longer applicable to the present day. For example, the liberal believes that when interpreting the Quran, there is no need to be bound by the knowledge of *Asbab al-Nuzul*, *Nasikh wa al- Mansukh*, Rasulullah SAW's the Prophet's interpretation, and the companions, or previous commentators. As a result, today's interpretation of the Quran and Hadith should be based on logic and rational thought. As seen by them, Islamic law as it has been practiced thus far is no longer relevant and even violates human welfare (Rosni Wazir et al., 2018).

Regretfully, 'Liberal Islam' activists claim that the methodology of interpretation of the Quran used by scholars so far has many flaws and is incapable of addressing current issues. The weakness of the interpretation methodology used thus far is that it is too "God-right" the text and ignores existing reality, underestimates the ability of reason, and falls short of using rational thinking to benefit Muslims (Zulaiha et al., 2021).

The 'Liberal Islam' movement rejects all interpretations of religion that are said to be old and archaic, including things that have become the consensus of scholars. Religion, for them, must be adapted to current reality, even if it means rejecting the religion's laws and rules that have been crucified with Islamic texts. If there are laws that are out of date, modern, human rights, global civilization, and not in line with the rationality of reason, the law should be delegated or otherwise abolished. On this basis, this group attempts to open as many doors to *ijtihad* as possible (Norarfan Zainal, 2019; Mohammad, 2006).

LIBERALISM AND ITS APPROACH IN THE INTERPRETATION OF THE QURAN AND HADITH

In interpreting the Quran and Hadith, the liberalists had used a lenient method against the methods applied by the traditional Muslim scholars (Abd. Rahim et al., 2019). Some of the methods are interpretation of the Quran with Quran (*Tafsir bi al-Ma'thur*), interpreting the al-Quran by independent reasoning (*Tafsir bi al-Ra'y*), interpreting the words mentioned in the al-Quran without depending on the pronunciations that can be understood clearly and normally according to the Arabic language (*Tafsir al-Isyari*) and other (Embong & Hanapi, 2017). However, these methods have been rejected by the liberalists due to the interpretation by Muslim scholars is not suitable with the modern issue such as gender issue, interfaith marriage and other. Besides, according to them, the previous approach is not in line with current modernization. Thus, the liberalists have their own methods instead of relying the rejected methods in the interpretation of the religious texts. The methods of liberalist as discussed by most of the previous studies are hermeneutics approach, relativism approach and socio-historical approach.

Hermeneutics Approach

Hermeneutics is the study of interpretation as well as its practical application. This technique leads to the description and interpretation of the essence of lived experiences and recognizes the meaning and importance of the experience collected in pedagogy, psychology, and sociology according to the lived experiences that are collected. The hermeneutics approach is one that is rigorous and is composed of processes of the ethical elements of day-to-day experience, both of which are difficult to access through the use of other typical research methodologies (Paterson & Higgs, 2015).

Besides that, hermeneutic phenomenology aims to elucidate lived meanings (R. Dangal & Joshi, 2020). This means that it makes an effort to describe and interpret the meanings of lived experience in a manner that is relatively rich and complex. This type of research is carried out through empirical (the collection of experiences) and reflective (the analysis of their meanings) activities. Hermeneutics focuses on the subjective experience of individuals and groups (Neubauer et al., 2019). Hermeneutics is an attempt to unveil the world as experienced by the subject through their life world stories.

Furthermore, the majority of modern scholars argue that Muslims do not understand the message of the Quran because of their lack of knowledge. So, the reinterpretation has been made to make the Quran as a guide and there is a tendency in the interpretation of the Quran to view the message behind its texts (Nur Zaitul Nadra Zainol et al., 2018; Bhutto, 2015).

Therefore, the reinterpretation of the Quran and Hadith by using the hermeneutics approaches need to be done. Harun Nasution for instance giving much freedom for intellectual (rational) to interpret the Quran and Hadith (Siregar, 2020). They aim to bring Islam in line with modernity.

Further, the movement of ‘Liberal Islam’ states that the more appropriate methodology to interpret the Quran in the context of modernity is hermeneutics. Based on their argument, it is more suitable due to precedes the theories of modern social science (Maofur & Yusoff, 2014). They also claimed that this approach has been proven to be very helpful in resolving the interpretation of verses that are considered unaccountable to modern humanitarian issues such as issues relating to gender equality, religious freedom, interfaith marriage, or relating to the human right in the Quran.

In Malaysia, Sisters in Islam (SIS) is an organisation that demonstrates the hermeneutics approach. The thought of reform via SIS is comprised of several different ideas. First and foremost, doing away with established religious authorities and placing more of a focus on the freedom of every individual to exercise *ijtihad*. They liberate themselves from the comprehension of the thoughts that previous ulama had regarding the interpretation of the Quran. The next step that SIS suggested was to reinterpret the Quran by rejecting the epistemology of the *‘Ulum al-Quran*, which had been produced by traditional Islamic scholars (Amin & Syarifah, 2021).

As a result, SIS reasoned that the Muslim scholars must have erred in their interpretation of the phrase “*al-rijal qawwamun ‘ala al-nisa*” which can be found in Surah al-Nisa, verse 34. This passage emphasises the responsibility of males to fulfil their roles as providers to women and caregivers. It does not imply that women are incapable of managing their responsibilities and obligations. According to SIS, this interpretation cannot be ensured because the terms used to suggest that males are physically and cognitively superior to women contain no truth. In addition, the teachings of Islam are in direct opposition to this interpretation, making it another reason why it cannot be accepted. Amina Wadud, who had been a member of SIS in the past, was a significant factor in influencing the organization's perception (Norzulaili et al., 2020).

Relativism Approach

The theory of relativism is an additional illustration of the liberal ideology's contradiction with Islamic teachings. The definition of revelation becomes relative and must be returned to the perspective of each person or civilization with its own beliefs, including Muslims (Maofur & Yusoff, 2014). Thus, the notion of relativism posits that ethical principles are relative to a certain environment or place (Al-Aidaros et al., 2013).

Based on this approach, there are no moral concepts that are totally correct, relevant, and applicable to all firms and people in all countries. This indicates that: first, various countries and societies may have distinct ethical codes and different countries and societies may have different ethical codes. Second, no criterion or concept can be utilized to determine if one societal code is superior to another. Third, the ethical code of a particular civilization has no special rank, implying that it is simply one of many. Fourth, there is no such thing as universal truth in moral or ethical concepts that can be held by all peoples at all times. Finally, a certain country's or society's moral code describes what is right inside that culture; if that country's or society's moral code indicates that a certain conduct is right, then that action is right at least within that society (Rachels & Rachels, 2012).

Subjective relativism, on the other hand, relates to the belief that “what makes an activity right for someone is that person approves of it” (Jr. & Lewis Vaughan, 2014). This philosophy is separated into two schools of thought: stringent relativism and lenient relativism.

According to strict relativism, there are no rights for mankind or universality, and all beliefs and religions are culturally tied to environmental compatibility. It is viewed as humanity's rights are always dependent on faith and surrounding ideals. The second, more forgiving viewpoint is that this relativism respects human rights as a principle while also accepting the potential of resemblance or dissimilarity between the surrounding value and the universal value (Aziz, 2016).

However, this argument is rejected in Islam and equally problematic. This is related to the viewpoint of Syeikh Yusuf al-Qaradawi (2004:3) who said that: "According to Islam, what is right and what is wrong cannot be left to a particular society because human beings have inherent weaknesses in that they will tend to behave in a manner that they see is convenient, regardless of whether such action is right or wrong. This is why Muslims have to base their actions on the words of Allah (Quran) and the Sunnah of the Prophet (Hadith)".

The principle of Musdah Mulia, a women's right activist and professor of religion from Indonesia is to reform the interpretation based on relativism approach. This notion suggests that all interpretations are relative by their very nature (Nasution et al., 2018). Musdah also asserts that while the Quran is an eternal truth, its interpretation is not eternal (Ediwibowo, 2015). This suggest that, there is no interpretation that is totally correct because the right interpretation might not be correct to others. This is due to the truth is very contextual depend on person or the place.

While in Malaysia, SIS presented the idea of relativism as the guiding philosophy to examine the Quran and Hadith. They emphasised that there is no single truth that is universally accepted (Amin & Syarifah, 2021). Thus, SIS scrambled to ensure that the Quran was given its original interpretation, with the meaning of the Quran that suits the demands of the modern era phenomena, and they began with the idea of freedom of thought and doing *ijtihad*. They did this so that the Quran could be given its original interpretation. Some of them are even more radical, believing that the Quran impacts by human touch. SIS also asserts that the insignificant interpretation of the Quran is the result of Islamic traditionalist scholars who have monopolised the interpretation of Islamic texts, particularly the Quran, then incorrectly amend *shari'ah* law due to gender bias, self-interest, politics, and patriarchal cultural heritage (Kamaruddin & Wan Ali, 2013).

Socio-Historical Approach

The socio-historical study of religion combines the goals, philosophies, and methodologies of historiography with those of the social and cultural sciences, which means that it examines the religious interpretation and practice through the lenses of socio-historical contexts, scientific discovery, and within each faith tradition. As a result, the settings around a specific religion become the major subject of research in order to better comprehend the genesis, evolution, and expression of the religion itself (Slade, 2020). The method employs a linguistic approach as well as approaches that take into account the role of history and the evolution of speech. Thus, by using this approach, an interpreter is intended to make the message consistent with the needs of the time and to create a realistic prediction about its future course (Rosyada, 2018).

Furthermore, this new strategy asks commentators to shift their paradigm from making the utterance the centre of interpretation to seeking moral principles (*maqasid shari'ah*) from the legacy of the verse. In an effort to keep up with modernity, liberal interpretations evolved, such as the interpretation that legalises gambling since it improves the economy and national growth (Maofur & Yusoff, 2014).

The socio-historical background of the Quran in its interpretation resulted in the creation of norms and ideals upon which jurists established the basis for deducing legal judgements. This context is crucial for making the Quran text relevant to contemporary

Muslims. It enables jurists to comprehend the relationship between the legal and ethical rules of the Quran and their historical and geographical relevance (Pakeeza & Chishti, 2012). Modernity has produced a new understanding of the Quran that is gaining favour among the population (Abbas et al., 2011). To properly comprehend a work, they say that social, political, and cultural conditions of the period should be considered. The movement of ‘Liberal Islam’ added their interpretation arguments not just with linguistic analysis, but also with hermeneutics and literary theory. In this manner, contextualists apply novel methods to approach the Quran while maintaining a connection to its historical context.

Moreover, the process of interpretation from a moral-social situational standpoint has two ways (Campanini & Higgitt, 2010). One method for interpreting the Quran is to comprehend the overall meanings in addition to the specific rules identified for individual situations. Consequently, it systematizes general ideas, values, and standards. The alternative approach consisted of generalising answers to specific situations and expressing them as socio-moral dogmas inferred from specific texts in light of the socio-historical context. This must be contextualised within a socio-historical framework.

Further, the socio-historical approach and non-bibliological approach are equivalent within the tradition of social sciences. The new method of the Quran interpretation does not rely on the old assumptions. All the provisions enumerated in the Quran are not permanent and are not implemented at all times or in all places. This is usually presumed when the Surah al-Ma’idah in verses 44-47: “Whoever does not judge by what Allah has revealed - then it is those who are the disbelievers, tyrants, and atheists”. This assumption should not be in that textual framework, but this has to be in ethical framework concepts derived from the Quran (Farchan, 2016). Overall, it is essential to situate a book within its historical context and give context precedence.

Besides, when compared to the times before the spread of Islam, it is impossible to deny that the Quran improved the dignity of women by enhancing their rights and standing according to SIS (2005). One of them states that a guy is not allowed to marry more than one lady if he is unable to treat each of them fairly (Zaitun Mohamed Kasim, 2002). For example, the verse 3 of Surah al-Nisa’ was interpreted by SIS based on the textual understanding that if a man is afraid that he cannot perform justice, then he may only marry one woman and strongly reject polygamy.

THE INTERPRETATION OF ‘LIBERAL ISLAM’ ON POLYGAMY

The ‘Liberal Islam’ expressed clearly their standpoints on certain issues that have been widely discussed by Muslims. The issues are varied from many aspects, but this study focuses on one issue only which is polygamy due to reason that it has many disputes and argument from liberal and non-liberal perspectives.

The most prevalent form of polygamy worldwide is polygyny. Polygyny, on the other hand, is the phenomena of a man having several marriages; polygamy is described as marriage between one individual and numerous spouses (Al-Krenawi, 2020). Since the Quran permits men to wed up to four wives, traditional textual experts frequently contend that polygamy is acceptable under Islamic law (M. Abdul Ghoffar, Abdurrahim Mu’thi, 2003).

Contrarily, the contextualist-feminist groups have the opinion that the primary purpose of the polygamy command in the text of the Quran is to ban the practice of polygamy itself (Alamgir, 2014). For instance, Sisters In Islam (SIS), an Islamic feminist organisation that advocates for the rights of Muslim women in Malaysia, holds that monogamy is strongly encouraged in Islam, and that polygamy is only permitted as an alternative form of marriage in

a very small number of very specific and limited circumstances (Musawah & Sisters in Islam, 2018). Meanwhile, the practise of polygamy, which was widespread prior to the advent of Islam, has been constrained by Islam, according to Surah an-Nisa' verse 4:3. Furthermore, the revelation of the verse in the same surah that permits polygamy under the condition that a man treats each of his wives justly occurred during a battle in which many men had perished, leaving behind war widows and orphans as a result of the battle. Due to the fact that men were the main breadwinners in mediaeval culture, widows found it challenging to support both their personal well-being and the orphaned children.

Nevertheless, depending on how Surah an-Nisa verses 3 and 129 are to be regarded, 'Liberal Islam' has diverse perspectives on the acceptability of polygamy when it comes to Quranic interpretation (Syarif, 2020). The scholars who sanction the practice of polygamy based on their textual interpretation, independent of the socio-historical verses (Abdullah, 2006). The anti-polygamy movement additionally makes an effort to clarify the text's main idea and aim. They look into how the passage fits into the whole revelation framework. Ultimately, anti-polygamy believed that it was antithetical to the essence of women and worst when polygamy can cause argument among wives and children (Pervez & Batool, 2016).

Moreover, in the verse 129 of Surah an-Nisa', Muhammad Abduh emphasizes the capability of a husband to administer justice among his wives (Abdurrahman, 2017). He acknowledged that some of the Prophet's companions did practise polygamy, but he argued that this was necessary due to the fact that there were more women than men in the population at the time (Khoiriah, 2018). In order to protect the safety of women during that time, polygamy was a prevalent practise. Additionally, the Quran explicitly emphasises the importance of treating spouses equally and acting in a just manner toward women. However, as may be seen in verse 129, the Quran also recognises the challenges of fully upholding these values.

Furthermore, SIS refers to an instance in which the Prophet Muhammad (PBUH) prevented his son-in-law Ali ibn Abi Talib from marrying a second wife while he was still married to Fatimah. This occurrence is cited in order to add to the prior argument's body of evidence that polygamy is not recommendable action in Islam. Ali ibn Abi Talib allegedly received a warning from the Prophet (PBUH) that he would never be allowed to wed another woman. He said: "... unless and until Ali Ibn Abi Talib divorces my daughter, for surely she is part of me and what troubles and agitates her, troubles and agitates me too; and what harm befalls her befalls me too" (*Sahih al-Al Bukhari*. Vol, 67. Hadith No. 163). The feminists have frequently used this Hadith as an evidence to oppose polygamy.

It is interesting to note that a previous study of 218 students on polygamy found that over half of respondents (47%), believe that it is a social or moral issue, and 34% believe that it is a kind of sexism. A polygamous marriage is also frowned upon by 51% of respondents, while 46% of respondents think it is an Islamic issue. Additionally, almost half of respondents (47%), believe that polygamy cannot be questioned because it is an Islamic custom. Moreover, 42% of respondents disagree that polygamy benefits men more than women. (Alamgir, 2014).

Moreover, SIS, in partnership with Universiti Kebangsaan Malaysia (UKM), Universiti Sains Malaysia (USM), and Universiti Malaya (UM), performed a countrywide study on "*The Impact of Polygamy on Muslim Families in Peninsular Malaysia*" from 2007-2012 (Musawah & Sisters in Islam, 2018). During the study, they conducted interviews with a total of 1224 people, which included husbands, first wives, second wives, children of first wives, and children of second marriages. As a result, the findings of the survey indicate that roughly 65%

of first wives who participated in the investigation were uninformed of their husbands' intentions to wed another woman.

What causes salt to aggravate wounds is, the majority of polygamous men were unable to meet the monetary and emotional demands of their families. The percentages indicate that after engaging in polygamy, 40% of husbands purposefully reduced the amount of money they contributed financially to their children, wives, and the general expenses of the home. In order to contribute financially to their families, over half of all first spouses went on to work greater hours. Since their husbands had married a second time, over 40% of them reported having the 'always' or 'often' feeling that their financial situation was precarious. Next, 64% of first wives reported that their husbands had not cooperated with the 'turn-taking' commitments that had been made. To make matters even worse, 77% of children from first marriages were dissatisfied with the amount of time spent with their fathers.

On the other hand, the requirements for polygamous marriages have not been strictly enforced by the Syariah Courts. 45% of husbands did not submit applications to the courts in order to start polygamous relationships. 50% of the husbands surveyed indicated that the court did not request any of their financial or medical information. Prior to these courts providing permission to their husbands to take on another wife, 60% of first wives were not called by the courts and asked for their opinions. This was the case even though the courts were the ones who decided whether or not their husbands could take on another wife (Musawah & Sisters in Islam, 2018).

CONCLUSION

In conclusion, it has been amply shown that the 'Liberal Islam' movement will reject any religious scripture that does not fit their preferred interpretation. They put up a number of strategies, including hermeneutics, relativism, and a socio-historical perspective, in order to reject. However, they will accept it to support their position as to what occurred in the polygamy issue provided the Quran and Hadith are consistent with their reasoning.

However, a lot of study regarding liberalism has been carried out by previous researcher, but there is only a few study that has been deeply carried out on the history emergence of 'Liberal Islam' in Malaysia. For instance, who is the figure who bring the ideology in Malaysia. Besides, there is only few studies that have been conducted on the interpretation of 'Liberal Islam' in marriage issue. On this basis, it is recommended to publish additional literature reviews on issues regarding the 'Liberal Islam' and their thoughts against the Islamic teaching. The notion put out by 'Liberal Islam' is perilous, yet it may also appeal to Muslims because they adopt a reasonable mindset in their approach. If serious action is not taken, it may put Muslims in danger. The study found that most of the previous studies agree that the approach taken by 'Liberal Islam' to practice Islam clearly deviated from sharia. The ideology of liberalism clearly contradicts to the perspectives of the Quran and Hadith, and the impact from the liberation idea is convulsive particularly to the Muslim communities.

REFERENCE

- Abbas, R. Z., Amin, M., & Ahmad, Z. (2011). Muslim response to modernity and a new strategy of peace in the world. *Interdisciplinary Journal of Contemporary Research in Business*, 2(9), 417–427.
- Abd. Rahim, R. A., Abdul Jalal, A. F., & Rosele, M. I. (2019). *Islam Liberal dan Ancamannya Terhadap Kelangsungan Ahl Sunnah Wal Jamaah di Malaysia*. Universiti Malaya.

- Abdul Rahim, A., & Abdul Rahim, A. (2014). A Study on Muhammad Iqbal's Framework of Ijtihad. *Islamiyyat*, 36(2), 5–14.
- Abdullah, S. (2006). *Interpreting the Quran*. Madison Ave, New York: Routledge
- Abdullah, S. (2014). *Islam and Religious Freedom: A Sourcebook of Scriptural, Theological, and Legal Texts*. Washington, DC: Georgetown University
- Abdurrahman, U. (2017). Penafsiran Muhammad 'Abduh Terhadap Alquran Surat Al-Nisâ' Ayat 3 dan 129 Tentang Poligami. *Al- 'Adalah*, 14(1), 25–43
- Ainul Illia. (2021). *Siasat Dana Asing Diberi Agensi AS Kepada NGO Pro-Liberal*. Retrieve May 5, 2022, from shorturl.at/aDKX7
- Al-Aidaros, A.-H., Mohd. Shamsudin, F., & Md. Idris, K. (2013). Ethics and Ethical Theories from an Islamic Perspective. *International Journal of Islamic Thought*, 4(1), 1–13.
- Al-Krenawi, A. (2020). *Polygamous Marriages: An Arab-Islamic Perspective*. Cham, Denmark: Springer International Publishing
- Al-Qaradawi, S. Y. (2004). *Faith and Life*. Cairo, Egypt: Al-Falah Foundation.
- Alamgir, A. (2014). Islam and Polygamy: A Case Study in Malaysia. *Social and Behavioral Sciences*, 114, 889–893.
- Ali, M. N. S., & Ismail, A. M. (2017). Konstruksi pelaporan pemikiran isu Liberalisasi Agama dalam portal Berita Harian dan The Star. *Jurnal Komunikasi: Malaysian Journal of Communication*, 33(1), 229–241.
- Amin, A. S., & Syarifah, M. (2021). Islam Liberal dan Pengaruhnya dalam Perkembangan Tafsir Al-Quran di Indonesia dan Malaysia. *Studi Ilmu-Ilmu Al-Quran Dan Hadis*, 22(138–155).
- Armayanto, H., & Ulfa, M. (2013). *Dekonstruksi Syariah Dalam Pernikahan Muslimah Dengan Non-Muslim*. 7(2).
- Awang, J., Zin, M. Z. M., Sakat, A. A., Nor, M. R. M., Kasmu, M. A., Kadir, M. N. A., Othman, F. M., & Majid, L. A. (2011). Islamic studies in Malaysia in confronting liberal Islam. *Advances in Natural and Applied Sciences*, 5(5), 432–439.
- Aziz, S. A. (2016). *Peranan NGO Terhadap Teori Relativisme*. Retrieve October 18, 2022 from shorturl.at/dntxH
- Badri, F. (2018). A genuine Islamic conceptualization of religious freedom. *Muslim World Journal of Human Rights*, 15(1), 1–27.
- BBC News. (2017). *Gay Muslim wedding*. Retrieve April 22, 2022 from shorturl.at/cejKW
- Bhutto, S. (2015). Hermeneutics from Islamic Perspective. *IJSRSET*, 5(1), 310–314.
- Britannica. (2021). *Marriage Definition*. Retrieve May 25, 2022 from shorturl.at/bpyHX
- Cambridge Dictionary. (2022). *Threat*. Retrieve October 21, 2022 from shorturl.at/bkSZ3
- Campanini, M., & Higgitt, C. (2010). *The Qur'an: Modern Muslim interpretations*. London, United Kingdom: Routledge
- Federal Contitutions, Government of Malaysia 1 (2009).
- Ediwibowo, S. (2015). The Debates of the Createdness of the Qur'an and its Impact to the Methodology of Qur'anic Interpretation. *Ulumuna*, 19(2), 353–388.
- Embong, A. H., & Hanapi, M. S. (2017). The Application Methods of the Holy Quran's Interpretations in Islamic-Related Research. *International Journal Of Academic Research in Business and Social Sciences*, 7(2), 521–535.
- Farchan, Y. (2016). Reasoning of Liberal Islam: A Study on Islamic Perspective in Liberal Islam Network Jakarta. *Journal of Social Science and Religion*, 1(2), pg. 180-198.
- G25. (n.d.). *Administration of Matters Pertaining to Islam*. 217–223.
- Goh, J. N. (2014). Fracturing interwoven heteronormativities in Malaysian Malay-Muslim masculinity: A research note. *Sexualities*, 17(5–6), 600–617.
- Hanafî, Y. (2016). Kontroversi Usia Kahwin Aisyah dan Kaitannya dengan Legalitas Perkahwinan Anak di Bawah Umur dalam Islam. *Jurnal Hukum Islam*, 15(2), 163–334.

- Harris, K. M. A. (2009). *Pluralisme dan Kesatuan Agama: Tanggapan Kritis Atas Nama Kebenaran: Tanggapan Kritis Terhadap Wacana Islam Liberal*. Bangi, Selangor: ATMA
- Islam, S. in. (2005). *Don't Enforce Dress Code on Women Undergrads*. Retrieve May 20, 2022 from shorturl.at/cfjW7
- Ismail, M. F., Tamuri, A. H., & Jasmi, K. A. (2012). *Pengaruh Elemen Islam Liberal Terhadap Aqidah Pelajar Sekolah Menengah Kebangsaan: Satu Tinjauan Awal*. International Conference on Research in Islamic and Arabic Language Education, 289–300.
- Ismail, S. Z., & Mat, M. Z. A. (2016). *Faith and freedom: The Qur'anic notion of freedom of religion vs. the act of changing religion and thoughts on the implications for Malaysia*. *Religions*, 7(88), 1–18.
- Jaeh, M. A., & Ismail, M. T. (2020). *Parti Keadilan Rakyat (PKR) dan Intelektual Liberal: Kelahiran dan Evolusi Idea*. *Akademika*, 90(1), 165–179.
- Jordan, M. C. (2013). *Liberal and Conservative Views of Marriage*. *Think*, 12(34), 33–56.
- Jr., T. S., & Lewis Vaughan. (2014). *Relativism, Truth and Reality*. Americas, New York: McGraw-Hill
- Kamaruddin, Z., Kamaruddin, W. Z., Ali, W., & International, S. (2012). *An Analysis of SIS's Understanding of Ijtihad from Islamic Thought Perspective*. *Afkar*, 13, 33–50.
- Kamaruddin, Z., & Wan Ali, W. Z. K. (2013). *An Analysis of the Method of Problem Solvings by SIS Through a Model of Quranic Hermeneutics from an Islamic Thought Perspective*. *Afkar*, 14, 33–50.
- Kasim, Z. M. (2002). *Islam and Polygamy*. Retrieve August 3, 2022 from shorturl.at/iwEMQ
- Khoiriah, R. L. (2018). *Poligami Nabi Muhammad Menjadi Alasan Legitimasi Bagi Umatnya serta Tanggapan Kaum Orientalis*. *Jurnal Living Hadis*, 3(1), 1.
- M. Abdul Ghoffar, Abdurrahim Mu'thi, and A. I. A.-A. (2003). *Lubaabut Tafsiir Min Ibni Katsiir. Sumatera Utara, Indonesia: Pustaka Imam Asy-Syafi'i*.
- Maofur, E., & Yusoff, M. Y. @ Z. M. (2014). *Pengaruh Liberalisme Terhadap Kajian al-Quran di Indonesia*. *Journal Usuluddin*, 40(5), 1–25.
- Mohamad, A., Ghazali, A., & Wan Ali, W. Z. K. (2021). *Isu-Isu Berkaitan Pluralisme Agama di Malaysia: Suatu Analisis Awal*. *Jurnal PERADABAN*, 14(1), 1–17.
- Mohammad, H. (2006). *Cabaran Akidah : Pemikiran Islam Liberal*. Persint, Putrajaya: Pejabat Mufti Wilayah Persekutuan
- MStar. (2011). *Kedutaan Malaysia Sedia Maklum Kehadiran Saya Di Ireland: Ariff Alfian*. Retrieve April 22, 2022 from shorturl.at/GT389
- Muhammad Atiullah, O., & Mohd Nor, D. (2009). *Kecelaruhan Fahaman Liberal Dalam Fiqh: Satu Kajian Mengenai Hukum Wanita Islam Berkahwin Dengan Non-Muslim*. 8(14), 23–24.
- Musawah, & Sisters in Islam. (2018). *Joint Report on Muslim Family Law and Muslim Women's Rights in Malaysia*. Geneva, Switzerland: Musawah
- Mutalib, M. M. A., & Sulaiman, M. (2017). *Understanding Religious Pluralism in Malaysia: A Christian and Muslim Debate*. *International Journal of Academic Research in Business and Social Sciences*, 7(13), 175–188.
- Nasir, M., & Omar, B. (2020). *Ideologi Islam Liberal: Respons Intelektual Muslim Malaysia dan Indonesia*. Bangi, Selangor: Universiti Kebangsaan Malaysia
- Nasution, K., Mohd Saad, M. F., & Wan Abdullah, W. N. (2018). *Pemikiran Musdah Mulia dalam Pembaharuan Pentafsiran Al-Quran*. *Islamiyyat*, 40(2), 161–168.
- Network, E. (2013). *Equal Marriage*. Scotland, UK: Equality Network
- Neubauer, B. E., Witkop, C. T., & Varpio, L. (2019). *How phenomenology can help us learn from the experiences of others*. *Perspectives on Medical Education*, 8(2), 90–97.

- Norarfan zainal. (2019). *Fahaman Islam Liberal Dan Penentangannya Terhadap Syari'At Islam*. 11(12), 1–17.
- Norzulaili, M. G., Mohd, R. A., Mohd Zohdi, M. A., & Nadzrah, A. (2020). An Analysis of Sisters in Islam's (SIS) Misinterpretation of the Gender Equality in the Quran. *Ma'ālim Al-Qur'ān Wa Al-Sunnah*, 16(2), 31–47.
- Pakeeza, S., & Chishti, A. A. (2012). Critical Study of Approaches To the Exegesis of the Holy Qur'an. *Pakistan Journal of Islamic Research*, 10(4), 19–26.
- Paterson, M., & Higgs, J. (2015). Using Hermeneutics as a Qualitative Research Approach in Professional Practice. *The Qualitative Report*, 10(2), 339–357.
- Pervez, A., & Batool, S. S. (2016). Polygamy: Chaos in Relationships of Children. *Pakistan Journal of Social and Clinical Psychology*, 14(1), 30–35.
- Pew Research Center. (2019). *Gay Marriage Around the World*. Retrieve April 22, 2022 from shorturl.at/eijU6
- R. Dungal, M., & Joshi, R. (2020). Hermeneutic Phenomenology: Essence in Educational Research. *Open Journal for Studies in Philosophy*, 4(1), 25–42.
- Rachels, J., & Rachels, S. (2012). The Challenge of Cultural Relativism. *The Elements of Moral Philosophy*, 14–31 from www.mhhe.com/RachelsEMP
- Ridzuan, F. N. ., Mokhtar, W. K. A. ., Amiruddin, A. A. R. ., & Jamaludin, A. . (2019). The Characteristic and Issues in Liberal Islam in Malaysia. *International Journal of Academic Research in Business and Social Sciences*, 9(11), 572–578.
- Rohmawati, R. (2016). Perkawinan Lesbian, Gay, Biseksual Dan Transgender/Transeksual (LGBT) Perspektif Hukum Islam. *Ahkam: Jurnal Hukum Islam*, 4(2), 305–326.
- Rosni Wazir, Abur Hamdi Usman, Najah Nadiyah Amran, Khairunnisa Ismail, & Mohd Nasiruddin Mohd Asri. (2018). *Hadis Ahad Menurut Perspektif Islam Liberal: Refleksi Terhadap Cabaran Penuntut Pengajian Hadis Di Malaysia*. In E-Proceeding of 3rd INHAD International Muzakarah & Mu'tamar on Hadith (IMAM 2018) (87–95). Bangi: Kolej Universiti Islam Selangor
- Rosyada, D. (2018). A Contextual Method of Interpreting the Qur'an: a Search for the Compatibility of Islam and Modernity. *Advances in Social Science, Education and Humanities Research (ASSEHR)*, 13,1–6.
- Sharkey, H. J. (2010). A religion, not a state: Ali 'Abd al-Raziq's Islamic Justification of Political Secularism. *Journal of Religion in Africa*, 40(3), 362–363.
- Siregar, A. (2020). Islamic Counseling in a Philosophy Perspective. *International Journal of Islamic Education, Research and Multiculturalism (IJIERM)*, 2(2), 116–134.
- Slade, D. M. (2020). What is the Socio-Historical Method in the Study of Religion. *Socio-Historical Examination of Religion and Ministry*, 2(1), 1–15.
- Sonneveld, N. (2017). From the Liberation of Women to the Liberation of Men? A Century of Family Law Reform in Egypt. *Religion and Gender*, 7(1), 88–104.
- Sulong, J. (2016). Pemeliharaan Akidah Islam: Analisis Daripada Sudut Penguatkuasaan Undang-Undang dan Fatwa di Pulau Pinang. *Jurnal Akidah & Pemikiran Islam*, 18, 1–34.
- Syarif, F. (2020). The Contextual Interpretation Of Polygamy Verses In The Qur'an. *Journal of Islamic Studies and Humanities*, 5(1), 1–13.
- Van Engeland, A. (2014). The Balance Between Islamic Law, Customary Law And Human Rights In Islamic Constitutionalism Through The Prism Of Legal Pluralism. *Cambridge International Law Journal*, 3(4), 1321–1348.
- Wan Ismail Wan Dagang, Mohd Nasir Masroom, Ahmad Syukran Baharuddin, & Mohd Ismail Mustari. (2015). Ancaman Pemikiran Aliran Islam Liberal Kepada Umat Islam di Nusantara. *Sains Humanika*, 3(16), 77–85.
- Zaidan, A. K. (1976). *Usul al-Da'wah*. Kairo, Mesir: Dar al-Bayan.

- Zainol, N. Z. binti N. (2018). *Ancaman Aliran Pemikiran Liberal Terhadap Akidah Ahli Sunnah Wal Jamaah*. In Prosiding Persidangan Antarabangsa Pemikiran Islam Kali Pertama (PEMIKIR 2018). Johor: Universiti Tun Hussein Onn
- Zainol, N. Z. N., Majid, L. A., & Md Saad, M. F. (2018). An overview on hermeneutics method application to the Quran by Muslim thinkers. *International Journal of Engineering and Technology (UAE)*, 7(4), 167–170.
- Zainuddin, N. (2019). *Kebebasan Mutlak Cetus Bencana*. Retrieve March 10, 2021 from shorturl.at/ijuAN
- Zuhri, M. A. (2016). Perkawinan Sejenis Dalam Kajian Islam. *Al-Ahwal: Jurnal Hukum Keluarga Islam*, 8(1), 87.
- Zulaiha, E., Putra, R. A., & Gani, R. A. (2021). Selayang Pandang Tafsir Liberal di Indonesia. *Jurnal Iman Dan Spiritualitas*, 1(2), 151–156.

Website-Based Clinic Medical Record Information System Design (Case Study: Nurul Hayat Clinic)

Dira Savira

*Information System, Faculty of Business Economics and Digital Technology,
Universitas Nahdlatul Ulama Surabaya, Indonesia*
dirasavira023.if18@student.unusa.ac.id

Rizqi Putri Nourma Budiarti

*Information System, Faculty of Business Economics and Digital Technology,
Universitas Nahdlatul Ulama Surabaya, Indonesia*
rizqi.putri.nb@unusa.ac.id

ABSTRACT

Nurul Hayat Clinic is a clinic owned by the Nurul Hayat Foundation and one of the social physician practices in the city of Surabaya. This clinic provides health services for people who can't afford it on condition that they bring a poverty certificate. Based on the results of interviews with the person in charge of this clinic has quite a lot of patients. However, the management of medical record data and patient reports is still manual, resulting in data that is not integrated and often medical officers have difficulty in finding examination history so that it is very time inefficient. In this study, it was designed using a prototype method and implemented using the native PHP programming language and MySQL for database management. The research stages started from literature study, needs analysis through observation and interviews, making prototyping, prototyping evaluation, system coding, system testing and system evaluation through interviews. The results of this study are a clinical medical record information system that features a doctor menu, patient menu, e-mail, drug menu, medical record menu, other record menu, and report features. Based on black box testing, it was found that the clinical medical record information system can function properly in every feature. Based on the results of interviews on the evaluation of the system, it was found that the system is easy to use and provides convenience in service to patients.

INTRODUCTION

Medical records are data records and documents about a patient's health, such as identity, examination and treatment. (Cahyono & et al., 2018). From various kinds of medical records, it can be processed into a patient information data for the clinic. The amount of data that is processed often takes a long time when searching for data, because medical record data is manually recorded in books so that human errors often occur. The patient's medical record will be used when the patient has a further examination. (Handiwidjojo, Wimmie, 2009)[1]. Nurul Hayat Clinic is one of the social physician practices where this clinic belongs to the Nurul Hayat Foundation in the city of Surabaya. This clinic has two polyclinics, namely general poly and dental poly. This clinic provides health services for people who can't afford it on condition that they bring a poverty certificate. Based on the results of the interview in charge of the clinic, there were 300 patients who came during the last 3 months. In a day, patients who come can reach 10-15 patients (Rahayu, 2021). In addition, in terms of recording medical records and reports on patient diagnoses at the clinic, it is still manual, so that medical record data is not integrated, medical officers find it difficult to find patient medical record data and are inefficient [2][3].

The current condition at the Nurul Hayat Clinic does not yet have a medical record information system that can assist in carrying out health service tasks for a medical officer, so that a medical officer in carrying out his services takes a long time to find medical record data that is still manual. Medical record recording is done manually by writing by the doctor on each patient data which is then given to the medical officer, after that the medical record data is collected and placed in a cupboard or drawer. Based on the problems that the clinic has and the importance of information systems in previous studies, the author tries to find a solution by designing a website-based Nurul Hayat Clinic Medical Record Information System. The method used in this research is prototyping, namely the stages of requirements analysis, making prototyping, prototyping evaluation, system coding, system testing, and system evaluation.

RELATED WORKS

The first research was conducted by (Raihan, 2021), namely, conducting development of a web-based clinical information system and using the waterfall method. With an information system that is integrated with this website, the process of health services at the clinic can be automated and make it easier for medical officers to complete their work [4].

Subsequent research was conducted by (Nur, Octaviansyah, & Romlah, 2021) which discussed the medical record data of clinical patients who were still manual, this often resulted in human errors. The solution given in this research is to develop a mobile and web-based clinical information system using the prototyping method. The results of this study can have a good impact, one of which is time efficiency and transaction recording can be integrated with other data [5].

Double spacing should only be used before and after headings as shown in this example. Position and style of headings and subheadings should follow this example. No spaces should be placed between paragraphs. Paragraph must be justified.

METHOD

Prototype Method

This section describes the methodology used in this final project. This methodology is needed as a systematic guide in working on the final project. In this section, the implementation phase will be explained in detail [6]. Based on the research methodology described above, the discussion of each stage in the research can be described as follows:

Figure 1. Prototype Model

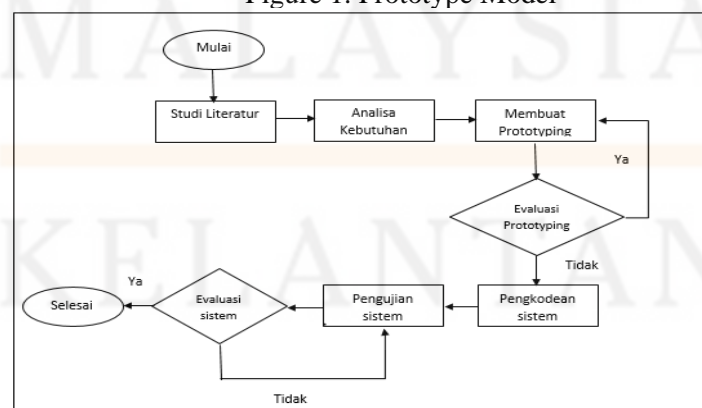

Stage in the Prototype Model

The following are several stages of the Prototype Method:

Stage 1: Study of literature

At this stage is the initial stage in making the final project. In this stage, a literature study is carried out by collecting library data, reading and taking notes and managing research materials. As well as looking for theoretical references from research journals that are relevant to the same case study, which is related to the design of the medical record information system and also the methods used.

Stage 2: Needs Analysis

The next stage is the needs analysis, which includes the information needed in the development of a medical record information system. The technique will be carried out using interview techniques and direct observation to medical officers as well as those in charge at Nurul Hayat Clinic with the aim of finding out information on user needs in the form of understanding business processes and a list of functional and non-functional requirements.

Stage 3: Making Prototyping

From the results of the needs analysis can be used as a reference for making prototypes. The process of making prototypes using Mockups that can display a visual description of the application. In making Mockups assisted by using Mockflow software to design the appearance of the system. Then when designing the system using Flowcharts and UML (Unit Modeling Language) diagrams such as use cases, activity diagrams and sequence diagrams.

Stage 4: Prototype Evaluation

At this stage, it provides the results of the prototyping design of the Nurul Hayat clinical information system to users in the form of medical record documents and provides direct explanations. After the user evaluates the suitability of the mockup and system design with the needs in the clinic by interview. If the results of the evaluation are in accordance with what the user expects by using interviews, the medical record information system can be continued at the coding stage. If there is a change from the evaluation results, the prototyping design will be updated later.

Stage 5: System Coding

In this stage, the coding of the system is carried out. Writing the program code is a stage in the translation of the prototype that has been made and approved by the user which will then be made in the form of commands or a language that is understood by the computer using a programming language. This system uses the programming language used, namely PHP Native and MySQL database.

Stage 6: System Test

At this stage the medical record information system that has been created will then be tested for the system. In this process, we will test the program code that has been made by focusing on the information system section. The goal is to ensure that the input used will produce the appropriate output. The tests carried out are using Black Box testing which is carried out to observe the test results on the test case table from entering data (input) on the features

Stage 7: System Evaluation

At this stage is the evaluation stage of the system which is evaluated by the user to determine whether the system has met the user's needs or not. The author evaluates the system by interviewing users. The author will interview medical officers as well as those in charge of clinics and doctors. If there are still deficiencies, the system must be repaired and if there are no deficiencies, the system is ready for use by the user.

Use Case Diagrams

Use case diagram is one of the techniques used to software design that describes the interaction between actors and systems. this use case diagram has two actors, namely: describes the response the system responds to the procedure doctors and medical staff. In the use case diagram, there are all the functions that required by each actor in accordance with the functional requirements in order to meet user needs.

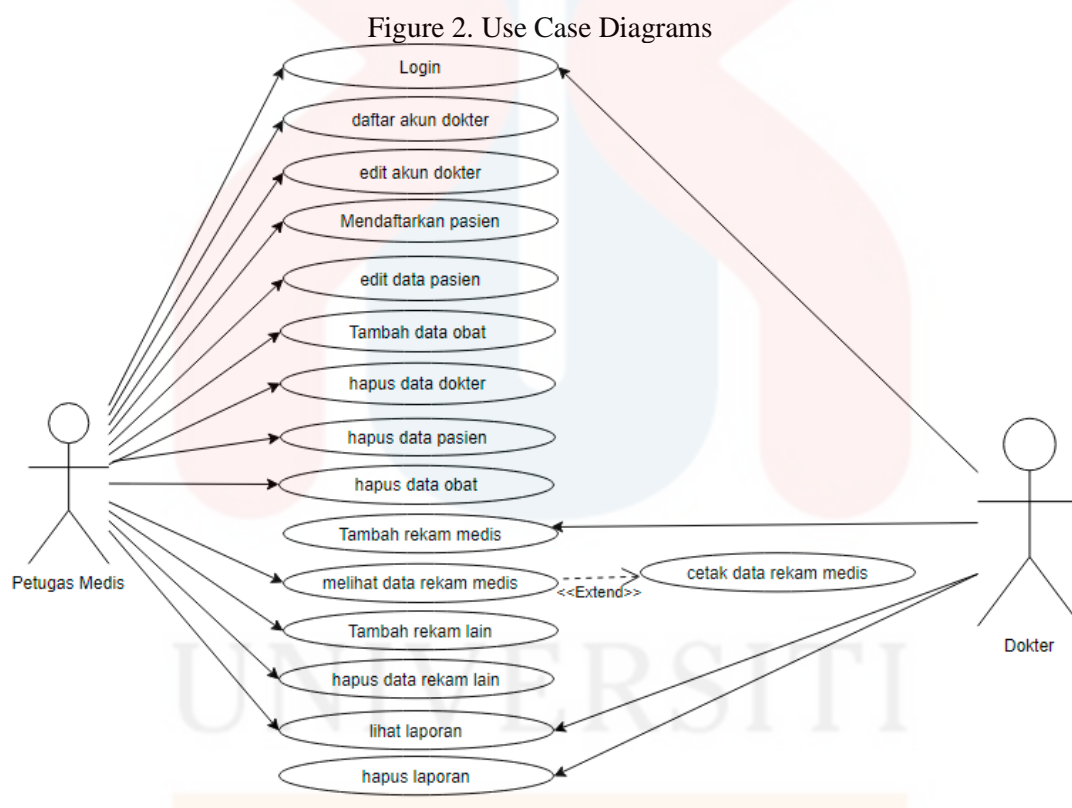

Entity Relationship Diagram (ERD)

Database design aims to facilitate or efficiency in doctors, drugs, medical records, other records and reports. In the patient entity there are 7 attributes, doctors have 5 attributes and medicine has 2 attributes, then there are 3 interrelated relationships storing, changing and reading data. There are six entities namely patient related, namely medical records and prescriptions. Nurul. Clinic Information System ERD life can be seen in Figure 3.

Figure 3. Entity Relationship Diagram

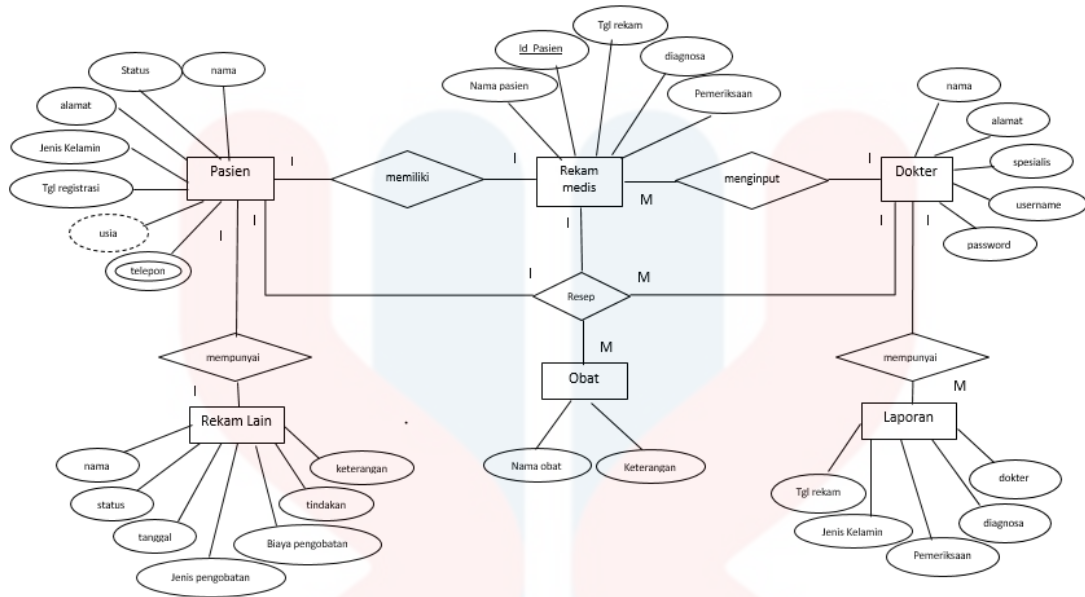

Activity Diagram

Activity diagrams depict various activity flows in system being designed, showing how each flow the process starts, the decisions that may occur and how the process flows ending the details are presented as follows: Another recording activity diagram is a picture of the actor's activity, namely medical officers add patient data that already exists in the record medical.

Figure 4. Other Record Activity Diagram

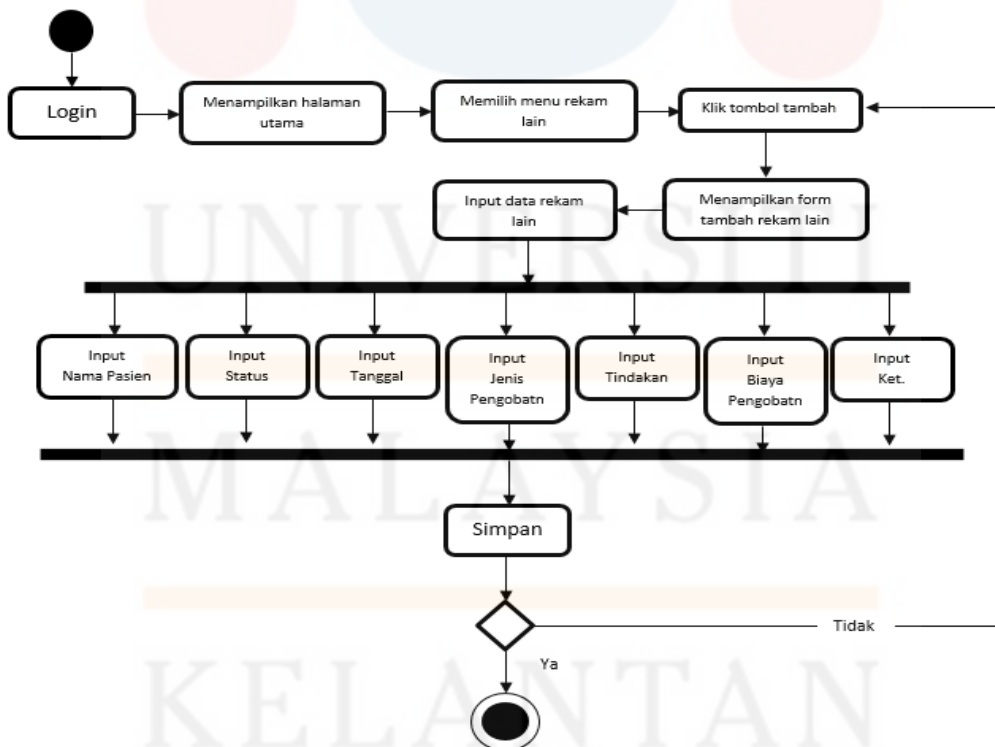

RESULTS AND DISCUSSIONS

Prototype Evaluation

At this stage, before making the system, the researcher provides an interface or mockup design in advance to prospective users, namely medical officers and doctors to provide evaluations. The prototype is a system interface that is submitted to potential users. Researchers conducted interviews with medical officers and researchers then evaluated the prototype interface design as described. The results of the evaluation of the main dashboard display, tables on the patient page and the medical record page.

System Coding

At this stage the researchers built a website-based clinical medical record information system. The tools used in building a website-based clinical medical record information system are Visual Studio, Xampp, Laptop and Internet Connection. At the development stage, as for the results of the development of a website-based clinical medical record information system. The following is the results of the development of a clinical medical record information system based on website at Nurul Hayat Clinic. There is a security system menu display (Login Form), Initial view of clinical medical records (Dashboard), Doctor Menu Display, Patient Menu Display, Drug Menu Display, Medical Record Menu Display, Other Record Menu Display and Report Menu Display.

Figure 5. Login Form

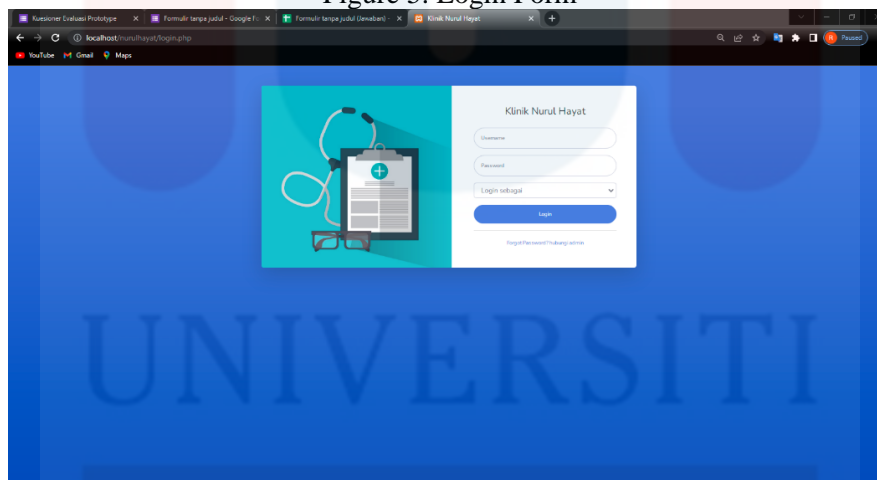

Figure 6. Dashboard

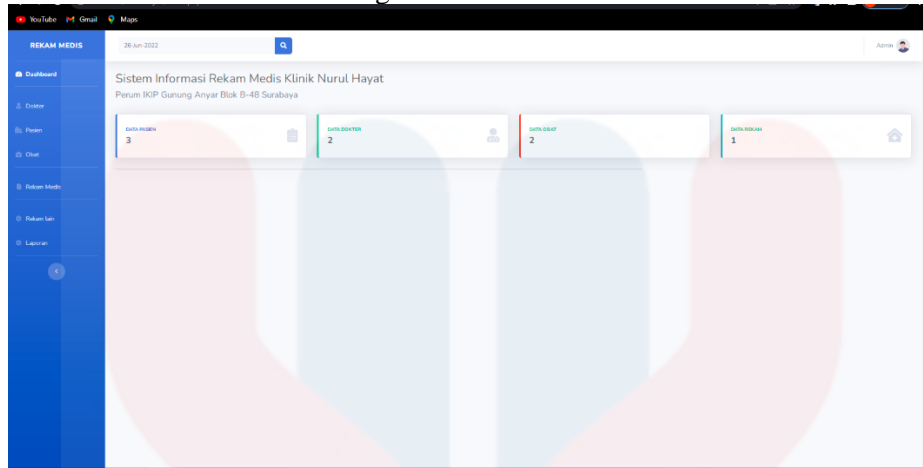

Figure 7. Doctor Menu Display

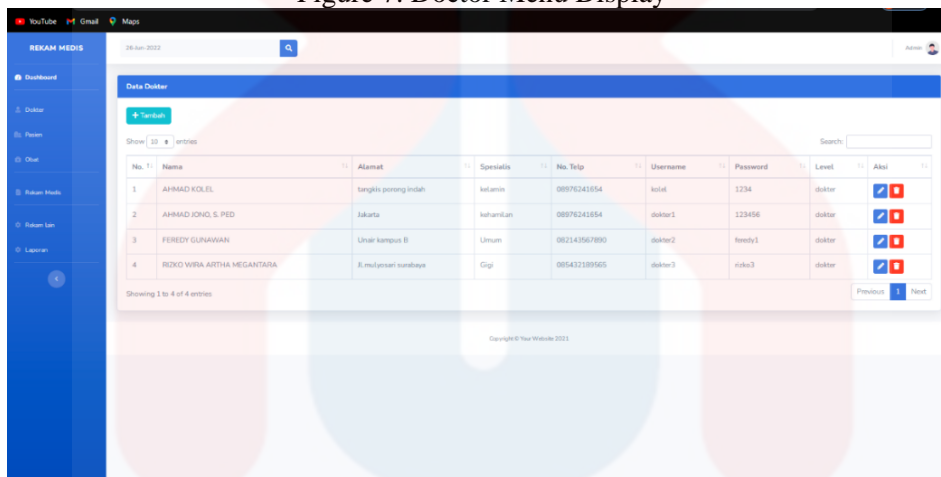

Figure 8. Patient Menu Display

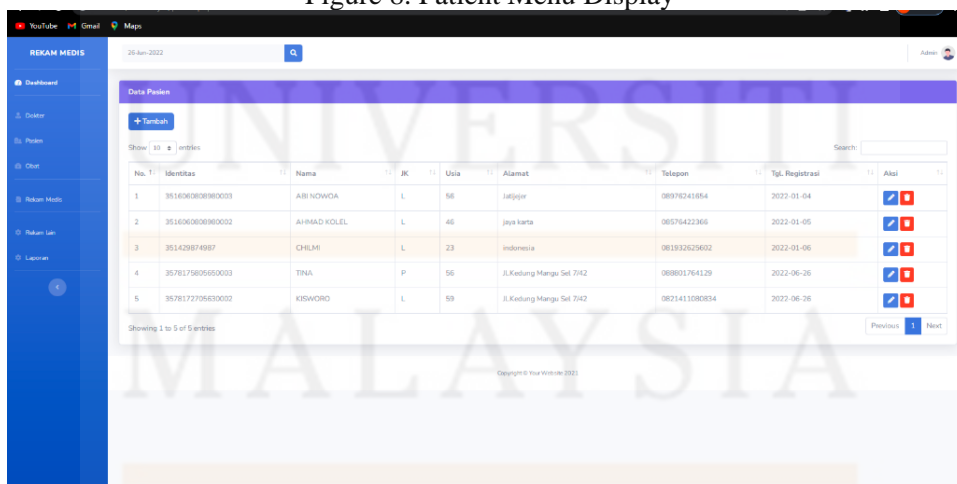

Figure 9. Drug Menu Display

No.	Nama Obat	Keterangan	Aktif
1	BODREX	sesudah makan	<input checked="" type="checkbox"/> <input type="checkbox"/>
2	NIKAGRIP	flu	<input checked="" type="checkbox"/> <input type="checkbox"/>
3	PARACETAMOL	demam	<input checked="" type="checkbox"/> <input type="checkbox"/>
4	AMOKLISIN	demam	<input checked="" type="checkbox"/> <input type="checkbox"/>
5	CATAPLAM	nyeri gigi	<input checked="" type="checkbox"/> <input type="checkbox"/>

Figure 10. Medical Record Menu Display

Data Rekam

ID: PS-003
 Nama: TINA
 Keluhan: sakit pada bagian kaki, demam, perut bagian kiri sakit
 Diagnosis: Demam
 Tanggal Rekam: 2022-06-26
 Dokter: AHMAD JONLS, S. PED

Obat yang diberikan

No.	Nama Obat	Keterangan	Tgl. Pemberian
1	PARACETAMOL	demam	2022-06-26

Figure 11. Other Record Menu Display

No.	Nama	Status	Tanggal	Jenis Pengobatan	Tiadakan	Biaya Pengobatan	Keterangan	Aktif
1	AHMAD KOLEL	Fakir Miskin	2022-01-09	gigitan	tidak	150000	terpapah	<input checked="" type="checkbox"/> <input type="checkbox"/>
2	yeni	Fakir Miskin	2022-06-23	umum	tidak	5000	sakit demam	<input checked="" type="checkbox"/> <input type="checkbox"/>

Figure 12. Report Menu Display

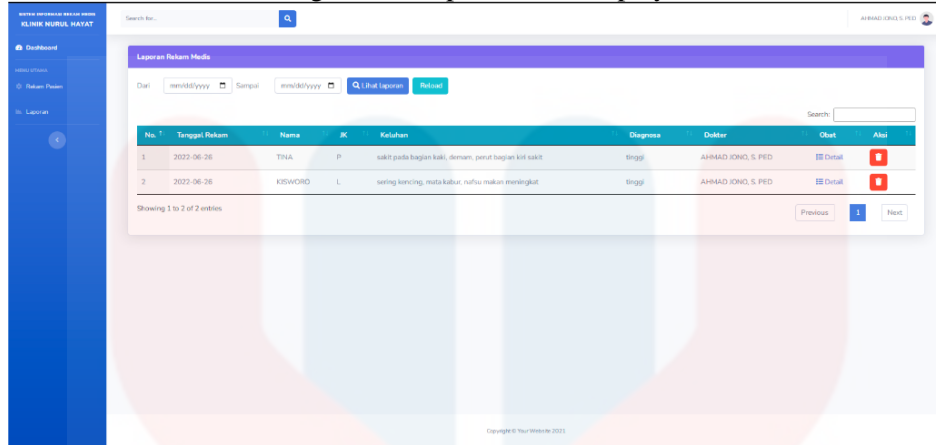

System Testing

Testing on this system is the BlackBox Testing where this test is carried out with the aim of the medical record information system at the Nurul Hayat Clinic based on the website avoiding errors and can be used by system users later. Based on Table 1, the test results show that the system is successful and can be used by users.

Table 1. Blackbox Testing

No	Feature	Scenario	Results that expected	Results
1	Login	Enter username and password (correct)	User successfully logged in and system display page dashboard	Success
		Enter username and password (wrong)	User failed to login, the system keeps redirecting to login page	Success
2	Dashboard Users want to see	and pressing the data feature	Display the data you want seen	Success

No	Feature	Scenario	Results that expected	Results
		patient, drug data, data doctor, medical record data other patient record data and report		
3	Page Doctor	<ul style="list-style-type: none"> • User click menu doctor • User click add • User click edit • User click delete 	<ul style="list-style-type: none"> • Display the view doctor menu • Fill in the doctor's data form • Add doctor data • Editing on the edit form data • Data deleted successfully 	Success
4	Page Patient	<ul style="list-style-type: none"> • User click menu patient • User click add • User click edit • User click delete 	<ul style="list-style-type: none"> • Display the menu view patient • Fill in the patient data form • Add patient data • Editing on the edit form data • Data deleted successfully 	Success
5	Page Drug	<ul style="list-style-type: none"> • User click menu drug • User click add • User click edit • User click delete 	<ul style="list-style-type: none"> • Display the menu view drug • Fill in the drug data form • Add patient data • Editing on the edit form data • Data deleted successfully 	Success

No	Feature	Scenario	Results that expected	Results
6	Page record medical	<ul style="list-style-type: none"> • User click menu medical records • User click details • User click save • User click print data 	<ul style="list-style-type: none"> • View pages medical record menu • Display data form medical records • Medical record data is successful saved • Medical record data is successful printed 	Success
7	Page another record	<ul style="list-style-type: none"> • User click menu another record • User click add • User click save • User click delete 	<ul style="list-style-type: none"> • View pages another record menu • Display the add form other record data • Other record data successful saved • Data deleted successfully 	Success
8.	Page report	<ul style="list-style-type: none"> • User click menu report • User click details 	<ul style="list-style-type: none"> • Displays the report menu • View report details 	Success

System Evaluation

At this stage the researcher evaluates the system aiming to find out the ease and satisfaction of using the system by users and without experiencing problems. The evaluation of this system is carried out by the user directly, namely by interviewing the medical officer as well as the person in charge of the clinic named Riris Kartika Putri and a general practitioner named Feredy Gunawan who are on duty at the Nurul Hayat Clinic accompanied by researchers and asking several questions. and it can be concluded. The conclusion from the answers to questions posed by researchers to medical officers is that the system is in accordance with what the user expects to have no difficulty when using the system, the features provided are easily recognized by the user and the system response is quite fast when the user processes input, edits and deletes data.

CONCLUSIONS AND RECOMMENDATIONS

Conclusion

Based on the results of the analysis of the medical record information system at the website-based Nurul Hayat Clinic, the following conclusions can be drawn:

1. Through interviews and observations, researchers succeeded in identifying functional and non-functional needs. For functional needs, namely being able to add and change doctor data, add and change drug data, add and change patient data, can view patient medical records, fill in patient medical record data, print medical record data, add and change other record data, view and delete medical record report. While non-functional requirements include the system being accessed through a laptop device and using a local server, the system can store patient information and other important data, the system can display data only based on user access rights that have been set, the system has an easy-to-understand display, software used PHP, MySQL, Xampp
2. The test results on the Clinical Medical Record Information System using blackbox testing get the results of the realization of 7 features tested that are in accordance with the expected results without any bugs or errors. After the blackbox testing has been carried out, the Nurul Hayat Clinic Medical Record Information System can be declared eligible for evaluation to users. The results of the evaluation of the system by conducting interviews by Medical Officers and Doctors get the results that the existence of a Clinical Medical Record Information System is more profitable and also provides convenience in its use so that this system can be said to have been in accordance with the needs of the Clinic

Suggestions

In this study, there are only menus for doctors, patients, drugs, medical records, other records and reports. Based on the results of the discussion of the clinical information system, the author provides suggestions for further research that can be done system development and the addition of more complex features such as adding medical support columns, physical examination results in the medical record feature.

REFERENCES

- [1] Prabowo, Daniel Wahyu Suprayoga, Triono, Joko (2021). Web-Based Medical Record Information System Design. *Journal of Pillar Technology* Vol.6 No.1.
- [2] Riyuska, Alkhairunas, Wildan (2016). Design and Build a Patient Data Identification System in Electronic Medical Records Using RFID Technology. *Journal of Physics Unand* Vol.5 No.1.
- [3] Amin, Muhammad, Maskur, Suharso, Wildan (2020). Design and Build a Medical Record Information System Using the Rapid Application Development (RAD) Model. repository.umm.ac.id
- [4] Junaidi, Ahmad, Zaman, Khairul (2019). Design and Build a Medical Record Retention Information System With Web-Based Imaging Method. *Journal of Information Technology and Computer Science* Vol.2 No.1.
- [5] Kurniadi, Dede, Mulyani, Asri, Annisa, Dhea Arynie Noor (2020). Design and Build a Medical Record Information System at the Clinic Using the Extreme Programming Method. *Journal of Algorithms* Vol.17 No.2.

- [6] Putranto, Ezekiel Yanu, Putra, Toni Wijanarko Adi, Hakim, Fitro Nur (2017). Web-Based Clinical Medical Record Information System Design (Case Study: Main Clinic Meditama Semarang). *Journal of Informatics UPGRIS Vol.3 No.2*.
- [7] Zaroh, Annisa Aulia, Irfan, Dedy, Tasrif, Elfi (2017). Design and Build an Information System for Medical Record Services at the Joint Dentist Practice in Tabing. *Vocational Journal of Electronics & Informatics Engineering Vol.5 No.2*.
- [8] Andra, Devista, Widiyatustuti, Akni, Susisanto, Didi (2019). Development of a Web-Based Medical Record Information System at the Gisting Health Center. *ONEISISMIK Journal Vol.3 No.3*.
- [9] Pasaribu, Johni S, Sihombing, Johnson (2017). Web-Based Outpatient Medical Record Information System Design at Margasari Health Clinic, Bandung. *Scientific Journal of Applied Information Technology Volume III.No 3*.
- [10] Assyifannisa, L. Adele B, Mailangkay (2021). Design and Build a Medical Record Information System for Alfa Dental Care Clinic with a Hybridapp-Based Rad (Rapid Application Development) Method. *Jakarta: Perbanas Journal*.
- [11] Santoso, et al. (2021), Design of -Based Medical Record Information System Web, *Infotech: Journal of Information Technology*.
- [12] Cahyono et al. 2018. Animal Clinic Medical Record Information System and Cattle Disease Diagnosis Expert System Using Certainty Factor Method. *Journal of the Faculty of Informatics Engineering Banjarmasin State Polytechnic : Banjarmasin*.
- [13] Samandari N A, Chandrawila S W, Rahim A H. The Power of Proving Conventional and Electronic Medical Records. *SOEPRA Journal of Health Law. 2016;2(2): 154-164*.
- [14] Raihan, Faza Muhammad (2021). Design of Medical Record Information System at Saffira Medika Clinic Batam. *SNATi Journal. Volume 1. Number 1*.
- [15] Nur, Octaviansyah, Romlah (2021). Mobile-Based Patient Medical Record Registration Management Information System (Case Study: Nurhasanah Maternity Clinic) *Journal of Technology and Information Systems, Vol (2), No. 2, 105 – 115*.
- [16] Indrajani. 2011. *Introduction and Database Systems*. Jakarta: PT. Elex Media Komputindo.
- [17] Pricillia, Titania, Zulfachmi (2021). Survey Paper: Comparison of Software Development Methods (Waterfall, Prototype, RAD). *Journal of Bangkit Indonesia Vol.X No.01*.
- [18] Wuner, Stevi A, Sengkey, Rizal, Lantang, Oktavian A. (2014). Analysis and Design of Web Based Unsrat Polyclinic Information System. *Informatics Engineering E-journal, Volume 4, No. 2*.
- [19] Jaya, Tri Snadhika. (2018). Application Testing with the Blaxbox Testing Boundry Value Analysis Method (Case Study: Digital Kanyor Lampung State Polytechnic). *Journal of IT Development (JPIT), Vol.03, No.02*.
- [20] Amanullah, Rizki Aziz. (2019). Web-Based Lung Medical Record Information System (Case Study: Karsa Husada Batu Hospital). *Informatics Engineering Universitas Brawijaya Malang*.
- [21] Suhlim, Wardah Lucianna. (2016). Design and Build a Course Scheduling Application at Stikes Foundation RS.DR.Soetomo. Surabaya: STIKOM Surabaya Institute of Business and Informatics.
- [22] Princess, Nadia Kusuma. (2018). Web-Based Dental Medical Record System Development. *Informatics Engineering Universitas Brawijaya Malang*.
- [23] Nurhayati, (2018). Indonesian Research Center Website Analysis Using Webqual For Website Quality Measurement. Pringsewu: *Journal of Information Systems and Telematics ISSN 2087-2062*.

- [24] Sugiarto, Alit, Ronggo, Hanifah, Umi. (2016). The Use of the Black Box Method in Testing Outgoing Mail Information Systems. Surabaya: Journal of UPN “Veteran” Scan Vol. Xi Number 2.
- [25] Pranatawijaya, Viktor Handrianus. (2019). Web-Based Survey Questionnaire Application Development Using Likert and Guttman Scales. Journal of Science and Informatics Volume 5, Number 2.
- [26] Susilowati, Tuti. (2017). Designing an Outpatient Registration Information System Using the Prototyping Method at the PKU Muhammadiyah Pakem Outpatient Clinic. Yogyakarta: Journal of Permata Indonesia Volume 8, Number 1.
- [27] Sihotang, Fransiska Prihatini. (2015). Analysis and Design of Medical Record Information System at Simpang Timbangan Health Center Indralaya. Palembang: Jatsi, Vol. 1 No. 2.
- [28] Rohman, Hendra. Yuyun, Ikhassani, Dyah Evanka Nur. (2019). Integrated Medical Record File Pretension System Design of Web-Based Information System at Pratama Clinic. Management Journal.

Gamification Book and Gamified Mobile Application to Learn Basic Terminology in Information Technology

Siti Nurul Mahfuzah Mohamad,
*Fakulti Teknologi Maklumat dan Komunikasi (FTMK),
Universiti Teknikal Malaysia Melaka (UTeM), Melaka, Malaysia*
mahfuzah@utem.edu.my

Mohd Azran Mohd Salleh
Kolej Komuniti Selandar, Melaka, Malaysia
mrzransalleh@gmail.com

Siti Hidayah Abd Rahim@Rahim
Maficomm Resources Sdn. Bhd., Malaysia
hidayahdit1.2@gmail.com

ABSTRACT

This study aims to publish a gamification book and a mobile application for primary schools to learn basic terminology in Information Technology that will help students learn more effectively. The target user of this study is primary school students. Results show that the top five game elements that should be designed in this mobile application are (i) Level; (ii) Achievements; (iii) Points; (iv) Rewards and (v) Collections. 85.2% of respondents prefer to use the Android app, followed by Windows and iOS respectively. This mobile application provides gamification elements to make the learning environment as in the game. Besides that, this mobile application has the multimedia element that can attract students to use it, such as the animation of moving images, videos, and quizzes among others. Findings show that most of the respondents agreed that the in-game directions are clear and easy to follow. There are eight topics of teaching and learning covered in this study. By using this mobile application, the students can learn in a fun and enjoyable way as well as improving student learning. In the end, the mobile application has been incorporated into a published version of the Gamification book, titled Siri Jelajah Teknologi (Asas Komputer) Bersama Siti & Tenno.

Keywords: *Gamification; Mobile Learning; Primary School; Information Technology; Education*

INTRODUCTION

Mobile application is a powerful new strategy to influence and motivate groups of people, especially primary school students. Indeed, using the mobile app with the Internet capabilities and applications can increase student learning and make it easier for them to access information (Ishaq et. al, 2020; Saneeka et al, 2022). Information technology content is now embedded in all subjects for primary school starting from 10-12 years old. Students nowadays are very independent and fast learners. They love to explore new things and adapt to technology. Also, the gamification approach is a powerful strategy to influence and motivate students. It improves user engagement by keeping a score of points earned through various activities on the application. Gamification is a movement to create an effect in the non-game content by applying the game element and game thinking that makes it fun. With this mobile application, the students can learn more effectively as it contains activities that they can feel like playing.

RELATED WORKS

Mobile application is a must for people nowadays, even for students. The mobile application that has been developed contains elements of gamification to help students learn the basic terminology of information technology more effectively. As mentioned before, students nowadays are more exposed to technology, gadgets, and other social media. The mobile application can be a good way to make learning more attractive. Students are more interested in playing games and the gamification elements can be applied in the application itself. Gamification can make them feel like they are playing a game. It is because they need to take challenges, get rewards, and see the progress that can make the student eager to try to earn more. (Khaddage et. al, 2014). In terms of instructional design, applying gamification without knowing what is gamification can be hard. It is because understanding gamification is needed and how it can benefit the learners (Lee, & Hammer, 2011). Other than that, gamification is designed for applying game elements in learning. However, if it is poorly designed, the student will feel hard to accept it (Lister, 2015). Also, it is imperative to know what game elements can match the motivational mechanisms (Mohamad et.al, 2019; Sailer et. al, 2013).

Based on Hamari et.al. (2014), mobile application has been a trending object and enhancing learning engagement. A lot of mobile applications for learning have been developed, but just a few mobile applications use gamification as their theme of interaction for the student. Vassileva (2012) mentioned that gamification only makes the users have a short motivation. However, Nicholson (2012) changed that by saying that gamification is an integration of the user-centered game design into a non-element game context. Naggar and Berkling (2020) also highlighted the design guidelines for engaging game design : (i) support reading information with related images or infographics; (ii) make it simple and short for beginning readers; (iii) simple instruction and flow of course map; (iv) connect the reader with all the information and (vi) give rewards after complete reading chapter.

Mohamad et al. (2017) listed twelve game elements that can be applied in teaching and learning activities. There are leaderboards, badges, points, levels, awards, progress, challenge, actions, rules, feedback, quest, and avatars. The most popular game mechanic applied in learning and teaching is a leaderboard that will show the rank, names, and score (Daud et.al, 2017). The second is a badge that will be awarded to the user after finishing a specific task. The third element is a point, followed by awards similar to the point that can turn into prizes. Fifth is the level to maximize the sense of achievement. Lastly is the avatar, where a student can select a character to interact with the system (Mohamad et al, 2018).

In the same fashion, use ideas from game design to enhance education (Sumitra, 2021). The goal is to increase students' engagement. Gamification allows the educator to set up an appropriate learning environment and implement game elements that can encourage student engagement. Huang and Dilip (2013) mentioned the 5-step process to apply gamification in education as shown in Figure 1.



MATERIALS AND METHODS

The initial aim of this study is to design and develop a gamified mobile application for primary school to learn the basic terminology of Information Technology and Communication (ICT) subject in order to help student learn in more interactive ways. Then, for the improvement and accessibility issues, the authors publish a gamification book with a little improvement that is suitable for book. Figure 2 shows the course map of mobile application while Figure 3 shows the course outline for gamification book.

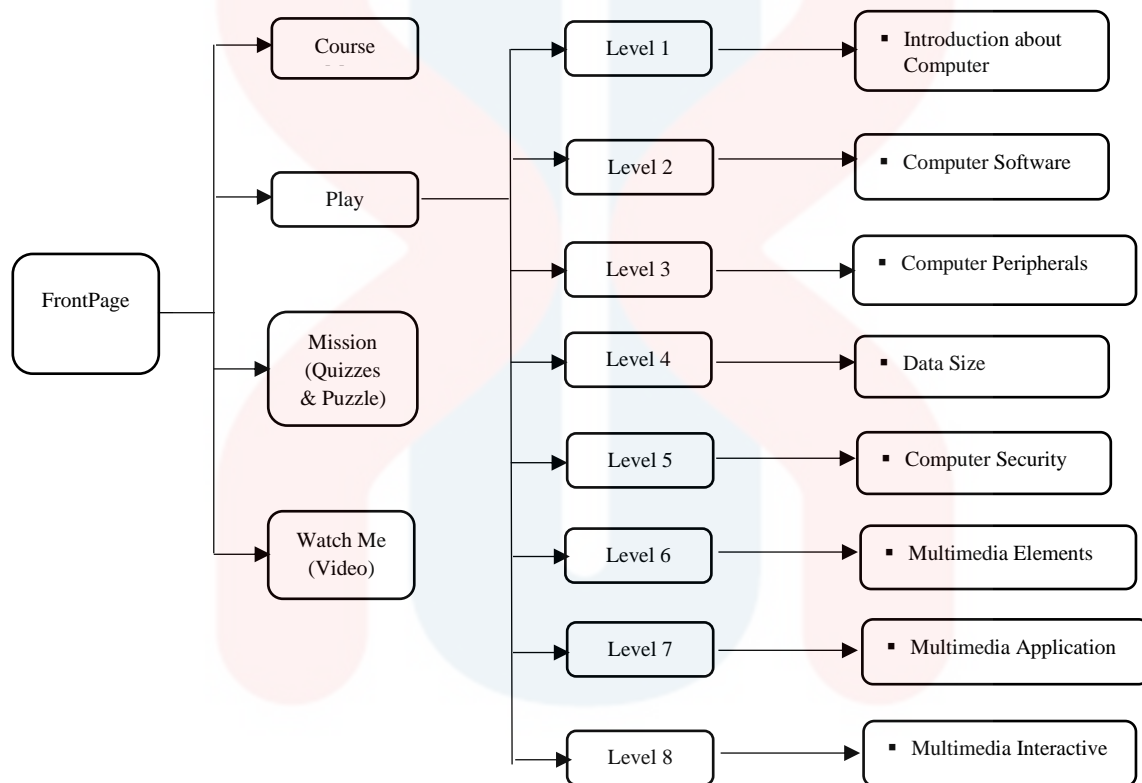

Figure 2. Course Outline for Mobile Application

The gamification book contains information about basic terminology in Information Technology, as well as pictures and infographics that are engaging and simple to understand. The distinction between this book and other books on the market is that readers can use the experience to learn about basic computer technologies. Parents can also guide their children at home to gain new experiences. The language chosen for both projects is Bahasa Melayu.

Media creation involves all the multimedia elements such as text, graphics, audio, video, and animation. The mobile application is compiled using Adobe Animate that utilizes Adobe AIR for Android platform. Through this software, testing and debugging for a mobile application can make developers know the errors. It is suitable for making a simple interface and application for mobile. For designing avatars and other illustrations, Adobe Photoshop and Adobe Illustrator are used in this study. In order to publish from mobile application to gamification book, Adobe InDesign is used to adjust the book layout, make necessary amendment and upgrade the contents.

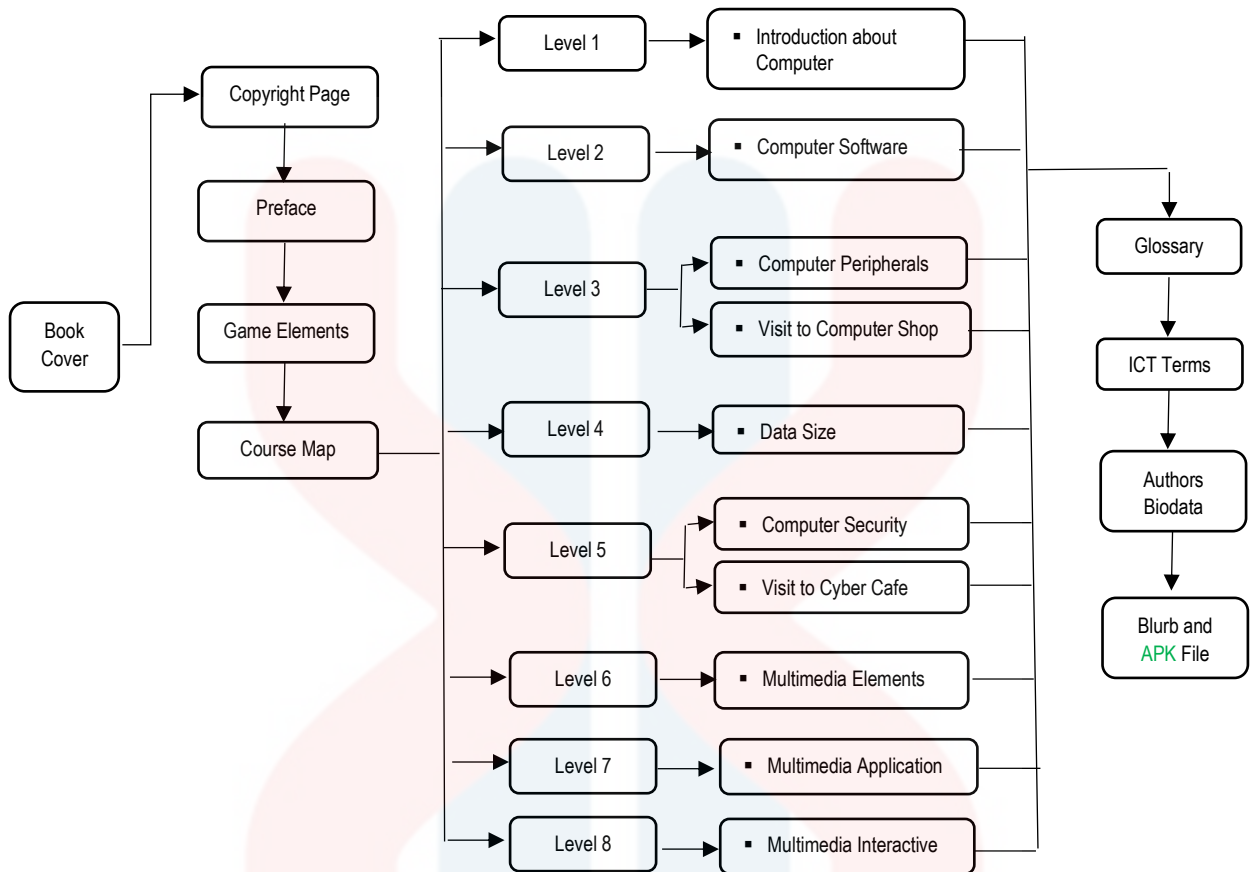

Figure 3. Course Outline for Gamification Book

The gamification book (Mohamad & Azran, 2020) are published in paperback versions and e-book as shown in Figure 4 and Figure 5. The platform to view e-books is at e-Sentral platform. E-Sentral is one of Malaysia's biggest e-book stores that consists of thousands of popular Malaysian and international e-books. Through the desktop computer or e-Sentral app, the reader can choose the book and read the e-book anytime and anywhere. The app allows users to read EPUB standard and PDF ebooks with and without Digital Rights Management (DRM).



Figure 4. E-Book version at e-Sentral Platform (Desktop View)

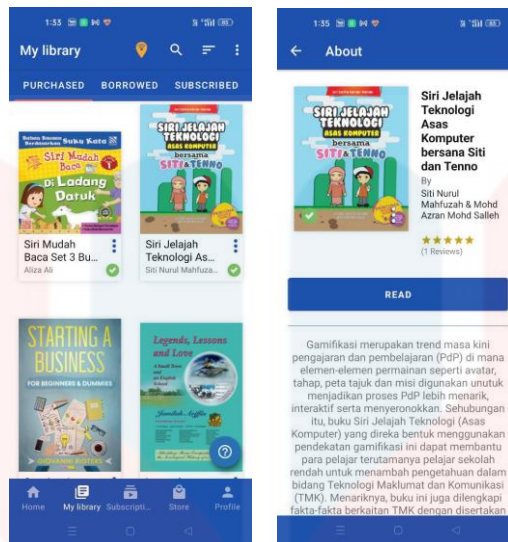

Figure 5. E-Book version at e-Sentral Platform (Mobile App View)

For visibility, all the paperback versions are selected by Malaysia National Library and distributed to all libraries as shown in Figure 6.



Figure 6. Visibility at Perpustakaan Awam

In this study, there are few game elements used as shown in Table 1. The game elements that are available in this study are (i) Avatar; (ii) Progress Map/ Course Map; (iii) Level; (iv) Storytelling; (v) Mission; (vi) Point. Table 2 shows the extra features for the mobile app version.

Table 1. Game Elements used in Gamification Book and Mobile Application

Game Elements	Gamification Book (Paperback and E-book)	Mobile App (Android Version)
<p><u>Avatar</u></p> <p>Avatar is a graphical representation of a user or the user's character. Student can choose the avatar to represent themselves.</p>		
<p><u>Progress Map / Course Map</u></p> <p>Refers to a visual representation of an entire chapter in a book or mobile application.</p>		
<p><u>Level</u></p> <p>Level will be unlocked after the user complete the mission in each level. The unlock functions only available on the mobile application.</p>		
<p><u>Storytelling</u></p> <p>This element is about telling the story and let the reader connect with a real life situation.</p>		

Table 2. Extra features for mobile application

Game Elements	Mobile App (Android Version)
<p><u>Mission</u></p> <p>Mission is designed as a challenge for the user to complete the task given.</p>	
<p><u>Self-Assessment</u></p> <p>Self-assessment, in the form of quiz, can encourage user's self-awareness on their progress.</p>	
<p><u>Point</u></p> <p>Point serves as a numerical representation of user's progress and is awarded when the user successfully accomplished certain achievement / progress.</p>	

FINDINGS

Identify Game Elements

115 students have been involved in this study. Results show that the top five game elements that should be designed in this mobile app are level, achievements, points, rewards, and collections. 85.2% of respondents prefer to use the app on the Android platform followed by Windows and iOS respectively. This gamification mobile application provides gamification elements to make the environment of the learning as in the game. Besides that, this mobile application has the multimedia elements that can attract students to use it such as the animation of moving images, videos, quizzes, and others. There are eight topics of teaching and learning based on the syllabus provided by the Ministry of Education. By using this mobile application students can learn with fun and enjoyment as well as improving students' learning performance.

Table 3. Top Five Game Elements

Game Elements	Rank
Level	1
Achievements	2
Points	3
Rewards	4
Collections	5

Pilot Test

The respondents for this pilot test are from five primary schools in Malacca. A total of 15 Subject Matter Experts (SME) (7 males and 8 females) and 15 students (10 males and 5 females) responded to this test. The instrument consists of demographic information and uses 5 Likert Scale items to determine the acceptance level towards the development of a mobile application to improve students' learning performance.

Table 4 shows the mean ranged from 3.07 to 4.53. The highest mean value is 4.53. It means that most of the respondents agreed that the mobile app is usable without a reference manual. Item 8 shows that most of the respondents agreed that the directions are clear and easy to follow.

The analysis in Table 5 revealed that no modification to smart device system settings was required with the highest mean 4.53. Item 1 is the lowest mean 3.07 (Screen directions are consistent and easy to follow).

Table 4. Ease of Use

No	Ease of Use	Mean
1	Title sequence is brief and can be by passed	3.07
2	Easy for user to operate independently	4.36
3	Mobile app is usable without reference manual	4.53
4	User can navigate the system without difficulty	4.33
5	Menus and other features make the system user friendly	3.53
6	User can exit from any screen	4.11
7	Directions are clear and easy to follow	4.20
8	The interface design is intuitive and provides easy navigation	3.95
9	Clear instructions are associated with menu and navigation	3.85
10	Functions of buttons are easily identified	4.17

Table 5. Technical

No	Technical	Mean
1	Screen directions are consistent and easy to follow	3.07
2	Program utilizes all the capabilities of the hardware	4.36
3	No modification to smart device system settings was required	4.53
4	Connectivity was consistent	4.33
5	Speed of access was good	3.53
6	The system runs properly	4.11

The Table 6 below shows that the majority of respondents believed that this application would be easy to use by a novice user, with a mean range of 4.35-4.36.

Table 6. Teaching Materials

No	Teaching Materials	Mean
1	Application can be used by all students.	4.35
2	Application is easy to use by novice user.	4.36

CONCLUSION & FUTURE WORK

To conclude, gamification is used to make learning and instruction more fun. Through mobile apps, learners can earn points, get feedback, feeling of accomplishment, and completely understand all topics. For future work, the authors would want to translate to other languages and extend to Augmented Reality technology to provide reader with more layers of information.

REFERENCES

- Hamari, J., Koivisto, J., & Sarsa, H. (2014). Does Gamification Work?—A Literature Review of Empirical Studies on Gamification. *47th Hawaii International Conference on System Science*, 3025-3034.
- Huang, W. H. & Dilip S (2013). A Practitioners Guide to Gamification of Education. Rotman School of Management. Universiti of Toronto.
- Ishaq K, Rosdi F, Azan N, Abid A. 2020. Usability and Design Issues of Mobile Assisted Language Learning Application. *International Journal of Advanced Computer Science and Applications*. 11(6):86-94.
- Khaddage, F., Lattemann, C., & Acosta-Díaz, R. (2014). Mobile Gamification In Education Engage, Educate Andentertain Via Gamified Mobile Apps. *In Society for Information Technology & Teacher Education International Conference* (pp. 1654–1660). Jacksonville, FL: Association for the Advancement of Computing in Education (AACE).
- Lee, J. J. & Hammer, J. (2011). Gamification in Education: What, How, Why Bother? *Academic Exchange Quarterly*, 15(2).
- Lister, M. C. (2015). Gamification: The Effect On Student Motivation And Performance At The Post-Secondary Level. *Issues and Trends in Educational Technology*, 3(2), 1-22.
- Meaghan C Lister, & Holland C (2015). Gamification: The Effect On Student Motivation And Performance At The Post-Secondary Level.
- Nicholson, S. (2015). A Recipe For Meaningful Gamification. In *Gamification in Education and Business* (pp. 1–20).Berlin, Germany: Springer.

- Naggar, El., & Berkling, K. (2020). Designing a Gamified Reading App with Pupils in Elementary School. CALL for widening participation: short papers from *EUROCALL 2020*, 63.
- Mohamad, S. N. M. & Azran, M. A.M. (2020). *Siri Jelajah Teknologi (Asas Komputer) bersama Siti & Tenno*. Malaysia, Penerbit UTeM Press.
- Mohamad, S. N. M., Azran, M. A.M, Mohd H. A. H., Linda K. M. S. & Che K. N. C. K. M. (2019). Adaptive Learning Strategies with Gamification to Enhance Learning Engagement. *Indian Journal of Science and Technology*. 12(31):1-8.
- Mohamad, S.N.M., Salam, S. & Bakar, N. (2017). An analysis of gamification elements in online learning to enhance learning engagement in Zulikha, J. & N. H. Zakaria (Eds.), *Proceedings of the 6th International Conference on Computing & Informatics* (pp 452-460). Sintok: School of Computing.
- Saneekaa, B., Shubham S., Avinash., Preeja. & Yogesh, K. (2020). Education Mobile Application. *International Research Journal of Modernization in Engineering Technology and Science*, 1387-1390.
- Sailer, M., Hense, J., Mandl, H., & Klevers, M. (2013). Psychological Perspectives on Motivation through Gamification. *IXD&A 19*, 28–37.
- Sumitra, N. (2021). Developing Gamification to Improve Mobile Learning in Web Design Course during the COVID-19 Pandemic. *International Journal of Information and Education Technology*. 11(12): 567-573.
- Vassileva, J. (2012). Motivating Participation In Social Computing Applications: A User Modeling Perspective. *User Modeling and User-Adapted Interaction*, 22 (1-2), 177–201. doi:<http://sci-hub.tw/10.1007/s11257-011-9109-5>
- Mohamad, S.N.M., Nur S. S. S, Mohd A. M. S. (2018). Gamification Approach in Education to Increase Learning Engagement. *International Journal of Humanities, Arts and Social Sciences*. 4(1): 22-32
- Daud,R., Salam, S., Mohamad, S.N.M., Yusoff, A. M. (2017). Modeling a Mobile Gamification Model to Increase Student Engagement: An Analysis Using Analytic Hierarchy Process. *Advanced Science Letters* 23 (9), 8707- 8712.

A Development Infographic Using Local Learning Source for Instructional Preparation of Basic Education Schools under Yala Primary Educational Service Area in the Southern Border Area

Nureeda Japakeeya

Faculty of Humanities and Social Sciences

nureeda.j@yru.ac.th

Nurhuda Sadama

Faculty of Humanities and Social Sciences

nurhuda.s@yru.ac.th

ABSTRACT

The objectives of this research were 1) To develop an infographic media “Local Learning Source” with an attempt to promote literacy and analysis of students at the basic education level in the southern border areas. 2) To compare students’ literacy for understanding before and after implementation in making use of the infographic media. 3) To analyze satisfactory of the infographic media “Local Learning Source” in promoting their literacy and analysis of the students. The subjects were students in Pratomasueksa 3 who came from Banyoh Yala School, Bannamdham Pattani School and Chumchonbansako Narathiwat School; there were 3 classrooms including totally 50 students. Materials used to conduct this research comprises of 1) Formatted interview questionnaires. 2) Learning management plan for the infographic media “Local Learning Source”. 3) “Local Learning Source” infographic media. 4) Evaluation form of infographic media “Local Learning Source” to promote literacy. 5) Satisfaction evaluation form of infographic media “Local Learning Source” The results were as follows: 1) The performance on infographics media “Local Learning Source” to promote literacy has an average result of 81.90/81.33. 2) The results of comparing the ability in literacy and analysis of students scored higher than the pre-test. When testing the difference in the results of literacy and the analysis of students before and after study, it indicates that there were statistically significant differences at the 0.01 showing that it is higher after the infographics were used. 3) Satisfaction analysis to infographic media “Local Learning Source” shows that the students were satisfied at the highest level.

Keywords: *Infographic Media; Local resources; Literacy; Southern border*

INTRODUCTION

Reading and writing are given a substantial of priority in Thai educational policy, as seen in the 2008 Basic Education Core Curriculum. The curriculum's objectives are to assist students acquire five critical competencies and establish a broad base of knowledge: 1) The capacity for communication; 2) The capacity for technological application 3. The capacity to reason; 4. The capacity to solve issues; and 5. The capacity to employ life skills, particularly those related to reading, thinking, analyzing, and writing, which are crucial competences that learners must continuously build. The National Education Act of 1999, as amended in 2002, mandates that the authorities encourage the formation and implementation of all kinds of resources for lifelong learning. It is crucial to instruct students to be aware of and utilize a variety of learning resources. A strategy was developed by the Committee on Basic Education, B.E. 2004–2010, for the government to provide assistance and encourage educational institutions to offer high-quality instruction and to take steps to develop learning resources inside of them. One method of problem-solving in teaching and learning is the utilization of local learning resources. Educational institutions must encourage the development of learning resources both inside and

outside the classroom in order to successfully complete the curriculum because they are important and associated to students' achievement. As a result, educational institutions should design extracurricular activities for students in a way that inspires them to develop to their fullest potential (Benjamas, 2007) In accordance with the provisions of Articles 23 and 24, emphasis is focused on instructional strategies that make use of local communities' learning resources and educational institutions. From the findings of the field trips to study the surroundings of the target schools, namely Ban Sako Community School, Si Sakhon District, Narathiwat Province, Ban Nam Dam School, Nong Chik District, Pattani Province, and Ban Yo School, Than To District, Yala Province, It was found that there are various learning sources and local wisdom as learning sources on sufficiency economy, rubber plantation, Thai traditional medicine including (Herbs, Nam phrai), nutrition (sato pickles, local desserts, orange fish), handicrafts (broom grass, khan mak, conifers), and paddy fields. Additionally, the school coordinates group projects to value of all goods for the community as a source of academic learning that teachers may employ to help students study and learn effectively. However, it was discovered from the actual evaluation of the target groups' schools that only a limited number of subjects or activities were being taught using the community's learning resources. Time, substance, the difficulties of learning outside of school, the situation in the three southern border provinces, etc. are only a few of the constraints that prevent curriculum objectives from being carried out. (Niderha, School Director of Ban Sakor School; Wongsawat, School Director of Ban Namdam School and Male, School Director of Ban Yoh School (Interview dates, 21-25 January 2019).

Ultimately, the students were able to comprehend the majority of the readings they were taught, but they struggled to express their reading-related information in words or letters. They also lacked the curiosity to seek out local knowledge within their own schools and communities. In addition, some students still struggle with deciding whether or not what they have learnt is accurate. The inadequacies are a reflection of exposure issues with analyzing, writing, and reading. The researcher proceeded to the area to interview more members of the target group of 30 students, who were divided into 15 students in early elementary school and 15 in higher elementary school. This was done using a simple random sampling method. It is clear that some students expressed dissatisfaction with the substandard instructional materials. So, understanding the text becomes quite challenging. Because they can make complex concepts simpler, infographics are one of the breakthroughs that attract a lot of attention. It is the presentation of information or knowledge that may be summed up as information in the form of data and graphics, such as line drawings, symbols, graphs, charts, diagrams, maps, etc., created as still images or moving images. In a brief and concise period of time, it is simple to perceive and comprehend. It can allow people to understand the meaning of all the information. Based on how people learn, infographics can therefore be incredibly effective teaching tools. This is because five sources of information are perceived by humans (sight, touch, hearing, smell, taste). Additionally, studies have demonstrated that vision is more crucial than any other source. Until the human brain is able to quickly process all of the benefits of information, 50% of it is employed for visual function. However, the brain is sub-brained in a straight line for the message, meaning it processes information sequentially from beginning to end, which makes it take longer for humans to understand text. Additionally, Phichanan Raksawong (2019) discovered that, in contrast to learning through hearing, reading, writing, and experiencing, 65% of the general population are visual learners. Infographics are therefore easily understood by all reader groups, including students, instructors, and other educational professionals, and they are accessible to the majority of people. Users are better capable of remembering difficult information. Information replication and dissemination are useful. Additionally, readability helps readers save time by allowing them to easily absorb complex material. Infographics are simple to draw attention to since they use eye-catching colors and patterns.

The researcher is therefore seeking to develop infographic media for learning resources and Local wisdom that supports literacy and analysis for students in basic education levels in the southern border areas in order that teachers can use them in teaching and learning, which will be useful in developing knowledge. This is because the conditions and problems mentioned above are what motivate the researcher to do this work. An awareness of how the learning process is organized utilizing academic sources, as well as the application of knowledge to enhance basic education teaching techniques in line with education reform and reform learning to suit and stay up with societal changes in this globalized age. Purposes of the Study Purposes of the Study 1. To develop infographic media entitled learning resource and local wisdom for promoting students' literacy and analysis in basic education levels in the southern border areas 2. To compare the students' proficiency on their literacy and analysis which include pre-test and post-test of grade 3 students 3. To investigate students' satisfaction towards infographic media entitled learning resource and local wisdom for promoting students' literacy and analysis in basic education levels in the southern border areas

METHOD

Research tools comprise of; 1) Structured interview for experts in content and design 2) Infographic learning management plans on Learning Resources and Local Wisdom 3) Reading Comprehension Test on Learning Resources and Local Wisdom 4) A satisfaction survey towards the infographic media on Learning Resources and Local Wisdom; Data Collection The participants completed the pretest by using the literacy and analysis test on Learning Resources and Local Wisdom; Students are instructed using graphical media on learning resources and local wisdom, which takes one hour; The students completed the posttest by using the literacy and analysis test on Learning Resources and Local Wisdom; Students completed a infographic media satisfaction survey on Learning Resources and Local Wisdom and The research collects data for subsequent data analysis.

DISCUSSION

1. Results from an analysis of the effectiveness of an infographic titled Learning Resources and Local Wisdom for Prathomsuksa 3 students in promoting literacy and analysis revealed that the mean of the criteria was higher than the criteria, which were 80/80, at 81.90/81.33. It appears that infographic media on learning resources and local wisdom for third-grade students could foster literacy and analysis. According to established criteria, it was successful in accordance with assumptions and objectives because infographics' nature facilitates in presenting content or messages to the target audience in a way that grabs attention and assistance in the target audience's understanding, and because infographics and tools were developed step-by-step. (See Table 1)

Table 1 Results of effective infographic entitled Learning Resources and Local Wisdom for Promoting Literacy and Analysis

Number of Students	Grades Through Semester				Grades after Semester	Percentage
	Set 1 (10)	Set 2 (10)	Totale (20)	Percentage		
50	397	422	819	81.90	610	81.33
	$E_1 = 81.90$				$E_2 = 81.33$	

Experts in both content and design are to provide guidance, suggestions, and improvements, including evaluating the level of quality of infographic-making tools developed

by the researcher in accordance with Phatcharee Muangmusik's research; Thanarat Sinthanakul and Jiraphan Srisomphan (2014) investigated the development of teaching materials with infographics through a network Management Information Systems, Master of Industry Program which is to develop and investigate the effectiveness. The findings revealed that the efficiency of teaching infographics in accordance with Meguigan's criterion was 1.09. The student's academic performance after using infographic was noticeably better than before at the.05 level, and the satisfaction survey score was 1.09. According to a survey of student satisfaction, a high level of student satisfaction was discovered with the improved teaching materials. Watcharaporn Saengphan (2010) investigated how Grade 2 students' reading comprehension of English changed as a result of utilizing Aesop's tales. It was discovered that creating English reading comprehension exercises for second-year secondary school students using Aesop's tales might assist them in building on their prior knowledge and improve their reading in each circuit according to their needs. Students perform better academically. The accomplishment test score of 21.03, or 70.09%, obtained by 28 students, or 75.67%, indicated that they had met the required standards, and the students were generally satisfied with the teaching and learning activities. Changjongpradit, Saengthong and Sarawan (2016, p. 24) Changjongpradit, Saengthong, and Sarawan (2016, p. 24) studied the development of teaching methods for primary school students to develop critical thinking skills; a case study of Khaothong School, Phayuha Khiri District in Nakhon Sawan Province revealed that when compared to before using the teaching approach to enhance analytical thinking skills, students' average analytical thinking ability scores were higher, which was statistically significant at the 0.05 level. Lumpkin (1991, pp. 3694-A) Lumpkin (1991, pp. 3694-A) examined the impact of teaching analytical thinking skills to level 5 and 6 students on their persistence and academic success. When taught with critical thinking skills, level 5 and 6 students have the same analytical ability. Level 5 students, both the experimental group and the control group, had learning achievement. The persistence in social studies content was no different. For level 6 students who were in the experimental group, the learning achievement and persistence in social studies subject matter were higher than the control group. The findings showed that level 5 and level 6 students have the same level of analytical ability when taught critical thinking techniques. Both the experimental group and the control group of Level 5 students exhibited learning achievement. The content in social studies persisted in the same way. The learning achievement and persistence in social studies subject matter were higher for level 6 students in the experimental group than they were for the control group.

2. A statistically significant difference was discovered at the.01 level in the comparison of the reading scores of grade 3 students before and after using infographic. After using infographics to teach, students received an average score that was higher than before. This might be a result of how infographic learning activities are set up to encourage literacy and analysis in accordance with the teaching and learning guidelines established by the researcher in the learning management plan through a systematical process of developing a process with an appropriate method. Also, it begins with the study plan's methods, techniques, guiding theories, and benefits. Creating a successful learning management system. (See Table 2)

Table 2 Comparative findings from evaluations of literacy and different pre- and post-analyses

Test	Number of Students	Points	Mean	Standard deviation	t-test Dependent	Sig.
pretest	50	15	2.9	0.74	-23.476	.00
posttest	50	15	12.20	2.69		0

The investigation of the effects of the development of English reading comprehension using Aesop's fables is consistent with Watcharaporn Saengpun's (2010) research. According to the study's findings, Mathayom Suksa 2 students were able to improve their prior knowledge and reading skills in each process by using Aesop's fables as the basis for reading comprehension tasks in English. This led to greater student performance in the study. The accomplishment test score of 21.03, or 70.09% of the 28 students, or 75.67%, indicated that they had met the requirements, and the students were generally satisfied with the teaching and learning activities as a whole. Phanomwan Pholsalee (2018) investigated the development of infographics based on the knowledge transfer theory titled Savings for the Future for Prathomsuksa 6 students. According to the comparison of learning achievement between pre- and post-learning scores, students achieved an average score of 18.67 before and after learning with infographic media based on the information transfer theory on saving for the future. The students' average scores were discovered to be higher than before. The median was at 25.24. The hypothesis was supported by the statistical significance of the t-test analysis between pre- and post-study at the .05 level. It is in accordance with Muhammadi's (2017) research on the efficacy of integrating infographics as a teaching platform and the development of fundamental knowledge and critical-thinking abilities for high school students in Makkah, Saudi Arabia. The goal is to determine how well infographics can be used to teach fundamental programming concepts to students in Makkah, Saudi Arabia, as well as to help them acquire more sophisticated analytical thinking abilities. The results demonstrate that using infographics to teach fundamental programming is an excellent method that is great for fostering critical thinking and other abilities.

3. According to the findings of a survey on the perspectives of grade 3 students regarding the media infographic titled "Learning resources and local wisdom," the children were most satisfied at a high level (\bar{X} : 4.76) with the aspect of advantages, design, and content. This might be the result of using infographics to manage instruction and learning. The media can help students learn until they have mastered reading comprehension because it is simple to understand and can make class more enjoyable. The selected color scheme is appealing to learners and interesting. Compared to just using the message, it makes it longer, more engaging, and more memorable. As a result, it is possible to comprehend massive volumes of data better and contribute to the development of analytical thinking abilities and thought systems (Patchara Wanichawasini, 2015).

Figure 1. Infographic (in Thai language) entitled Learning Resources and Local Wisdom at Ban Yo School (Pla Som)



Figure 2. Infographic (in Thai language) entitled Learning Resources and Local Wisdom at Ban Sakor (Suanyang)



Figure 3. Infographic (in Thai language) entitled Learning Resources and Local Wisdom at Ban Namdam (Plaeng Kaset)



Additionally, the content was developed by combining data from surveys of the region and interviews with people connected to the target group of schools, encouraging students to have reading and analytical abilities while allowing them to learn independently. As a result, students are more motivated to learn and are satisfied while using infographics to learn and develop. This is in accordance with study by Patchara Wanichawasin (2015), who investigated the potential of infographics enhancing learning quality. She discovered that 94.99% of respondents agreed that infographics enhanced interest, comprehension, and recognition. And the second dimension is that using infographics as instructional materials leads to learning

satisfaction by achieving the targeted learning objectives through clear and effective communication. Infographics as a learning tool have been discovered to provide the highest level of satisfaction, with an average score of 4.82, according to the same study. The use of Simpson cartoons in social studies instruction was examined in research by Scarland et al. (Sternburg et al, 2000). The best technique to assist students build thinking abilities and clearly understand social features is to utilize cartoons in teaching and learning since they are up-to-date and consistent with current events, which improve student learning outcomes. Students are satisfied and have fun learning. In Phanomwan Pholsalee's (2018) research, the theory-based evolution of infographic media was investigated. According to the knowledge transfer theory on saving for the future, the knowledge transfer on saving for the future for grade 6 students discovered that the students were satisfied with the infographic media. Overall, it's at the highest level and also in line with Yildirim's (Yildirim, 2016) research on educational infographics that consider the reader's characteristics. This study sought to illustrate the perspectives of students who used infographics to assist their learning. The results showed that the infographics learning program's participants were satisfied and enthusiastic advocates.

REFERENCES

- Changjongpradit, S., Saengthong, S., & Sarawan, P. (2017). Teaching development to improve the analytical thinking skills for elementary school students: a case study of Khao Thong School Phayuha Khiri District, Nakhon Sawan Province. *Journal of Social Sciences Academic*, 10 (Special Edition), 23-39. (In Thai)
- Lumpkin, C. R. (1991). *Effects of Teaching Critical Thinking Skills on The Critical Thinking Ability, Achievement, and Retention of Social Studies Content by Fifth and Sixth-Graders*. Retrieved May 25, 2020, from <http://proquest.umi.com/pqdweb/?did=745150621&sid=3&Fmt=2&clientId=71090&RQT=309&VName=PQD>
- Mohammadi, Najwa Al. (2017). *Effectiveness of Using Infographics as an Approach for Teaching Programming Fundamental on Developing Analytical Thinking Skills For High School Students in the City of Makkah in Saudi Arabia*. Makkah: University of Jeddah.
- Pacharee Muangmugsik et. al. (2013). *Development of teaching materials with infographics through a systematic subject network management information in Management Information System course*. (Master of Master of Science in Technical Education Thesis), King Mongkut's University of Technology North Bangkok.
- Panomwan Polsali. (2018). *Development of infographic media based on transfer of learning on the topic of saving for the future of primary 6 students*. (Master of Education Thesis in Technology and Educational Communication), Rajamangala University of Technology Thanyaburi.
- Patchara Vanichvasin. (2015). The potentials of using infographics in enhancing the quality of learning. *Panyapiwat Journal*, Vol.7 (Special Issue), 227-240.
- Pichanan Raksawong. (2019). *The Development of Infographic for Industrial Safety*. Maha Sarakham Rajabhat University.
- Shadech, Benjamas. (2007). *Learning Resources Administration of the Basic Educational Institutes of Bangkok Primary Educational Service Area Office 2*. (Master of Education Theses in Educational Administration), Bangkok: Suan Sunandhra Rajabhat University.
- Sternberg, R. J. and Grigorenko, E. L. (2000). Teaching for Successful Intelligence to Increase Student Learning and Achievement. *PhiDelta Kappan*. 79(9): 667-669

Watcharaporn Sangpan. (2010). The development of english reading comprehension activity Using aesop's fable for mattayomsuksa ii students. *Journal of Education Graduate Studies Research*, 4 (special issue).

Yildirim, Serkan. (2016). Infographics for Educational Purposes: Their Structure, Properties and Reader Approaches. *Journal of Educational Technology*, 15(3), 98-110.



UNIVERSITI

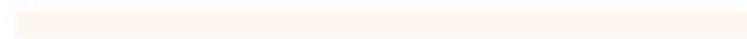

MALAYSIA



KELANTAN

The Influences of Organizational Culture, Work Discipline, and Leadership Style on Teacher Performance at Islamic Middle Education Institutions Tikung Lamongan

Abdul Ghofar Farisatul Habibi
Universitas Nahdlatul Ulama Surabaya
abdulghofar18student.unusa@gmail.com

Ubaidillah Zuhdi
Universitas Nahdlatul Ulama Surabaya
ubaidillah.zuhdi@unusa.ac.id

ABSTRACT

This study aims to determine how the significant performance influence of organizational culture, work discipline and leadership style variables on teacher performance at the Tikung Lamongan Islamic Junior High School educational institution. The research method used in this research is a questionnaire, namely by distributing questionnaires that are distributed based on the research objectives. The number of respondents who were taken for the study were 32 respondents. Using probability sampling method with accidental sampling technique and the method used in analyzing the data in this study using SPSS version 20. Based on the data analysis conducted, the results obtained that organizational culture has no significant effect on teacher performance, Then organizational culture, work discipline, and leadership style simultaneously have a significant effect on teacher performance.

Keywords: *Organizational Culture, Work Discipline, Leadership Style, and Teacher Performance*

INTRODUCTION

The principal is the school's goals and objectives through programs that are carried out in a planned and gradual manner. Schools have a very important role in mobilizing, and harmonizing all educational resources available in schools and using them as needed. A school principal as an educational leader faces a heavy responsibility, for that he must have adequate preparation, both mentally and psychologically in carrying out his duties, especially in dealing with various problems faced by teachers. The Tikung Islamic Junior High School was founded by the Lamongan Islamic Education Foundation. The Tikung Islamic Middle School as an educational institution has several activities that involve teachers and students, with the hope that many students will practice these activities after school. This foundation oversees 3 institutions consisting of Ulil Albab Islamic Boarding School, Tikung Lamongan Islamic Middle School, and Tikung Lamongan Islamic Vocational School. This year the number of teachers and students according to data from the human resources of SMK Islam Tikung is 181 people.

Based on a survey conducted on school principals who said that there was a low number of work disciplines they got at the institution, this was due to changes in the system related to learning at the institution so that everything was well organized. With the learning-related system in previous years, many teachers agreed with the system, because they were already familiar with the regulations. In previous years, all teachers were able to carry out learning activities based on their own will, therefore, the principal changed the learning system so that it could be well organized. The teacher's discipline attitude is seen from the teacher's awareness to follow school rules and regulations that are in accordance with their profession and matters

related to time management. Work discipline for teachers is related to the ability to perform in accordance with the rules that have been made by the school. This is not only limited to physical discipline based on the percentage of attendance or delay according to working hours, but also includes the punctuality of completing administrative tasks that support the main tasks according to the predetermined deadline.

METHODS

This study uses probability sampling, that is, each member of the population has the same opportunity to become a respondent, on the sampling process. The sampling technique used was accidental sampling. According to Sugiyono (2009), accidental sampling is a sampling technique based on chance, that is, respondents who coincidentally meet with researchers to use samples, if it is deemed that the person who happened to be met is suitable as a data source. In this study all members of the population were taken, due to the limited population and assistance from the institution in conducting research both in terms of time, energy, support, and thoughts. Therefore, the samples taken are truly representative (really representative).

Referring to the problem formulation and research objectives that have been set in the previous chapter, the type of research used is research using quantitative methods to test and prove hypotheses that have been made through tests and data management. Quantitative research is a type of research that produces findings that can be obtained using statistical procedures (Sujarweni, 2015). More specifically, this study uses multiple regression analysis as an analysis tool.

HYPOTHESIS TESTING

This study uses a significant value of 0.05 or r count. The relationship between variables can be said to be significant if the value of t table > 0.05. The following is the t table value obtained in this study:

Table 1. Hypothesis Testing

Hypothesis	Variable	Table t value	Table r Value	Table F value
H1	Organizational culture	0.480	0.349	20,996
H2	Work discipline	0.000	0.349	20,996
H3	Leadership style	0.061	0.349	20,996
H4	Teacher performance	-	0.349	20,996

Hypothesis 1 (It is suspected that there is no significant influence between organizational culture on teacher performance) Based on the test results shown in table 1.1, it shows that organizational culture has no significant effect on teacher performance. This result is strengthened by showing the significance value is greater than 0.05 with a value of 0.480 and an F value of 20.996. Which means H1 is rejected.

Hypothesis 2 (It is suspected that there is a significant influence between work discipline on teacher performance) Based on the test results shown in table 1.1, it shows that work discipline has no significant effect on teacher performance. This result is strengthened by showing the significance value is less than 0.05 with a value of 0.000 and an F value of 20.996. Which means H2 is accepted.

Hypothesis 3 (It is suspected that there is no significant influence between leadership style on teacher performance) Based on the test results shown in table 1.1, it shows that leadership style has no significant effect on teacher performance. This result is strengthened by showing the significance value is greater than 0.05 with a value of 0.061 and an F value of 20.996. Which means H3 is rejected.

Hypothesis 4 (It is suspected that there is a simultaneous significant influence between organizational culture, work discipline, and leadership style on teacher performance) Based on the test results shown in table 1.1, it shows that organizational culture, work discipline, and leadership style influence simultaneously significant on teacher performance. This result is strengthened by showing the value of the F test is 20.966 with a level of $0.000 < 0.05$, which means that the variables of organizational culture, work discipline, and leadership style simultaneously affect teacher performance. Which means H4 is accepted.

CONCLUSIONS

Based on the results of research conducted under the title The Influence of Organizational Culture, Work Discipline, and Leadership Style on Teacher Performance, organizational culture has no significant effect on teacher performance, the following conclusions are obtained:

Conclusion 1 is: organizational culture has no significant effect on teacher performance. It can be concluded that the independent variable is not able to affect the performance of teachers at the Tikung Lamongan Islamic Junior High School. This means that this study shows that school culture has no effect on teacher performance. The school culture indicator in this study found that the culture of paying attention to every problem in detail had not been fully implemented by the principal so that many teachers in carrying out their duties were not in accordance with the regulations made by the principal.

Conclusion 2: work discipline has an effect on teacher performance. It can be concluded that the independent variable is able to affect the performance of teachers at the Tikung Lamongan Islamic Junior High School. This means that work discipline has an influence on teacher performance, because work discipline is able to become a driving force for the willingness and desire to work according to the standards or limits set so that it is clear that work discipline should be owned by a teacher.

Conclusion 3 is: leadership style has no significant effect on teacher performance. It can be concluded that the independent variable is not able to affect the performance of teachers at the Tikung Lamongan Islamic Junior High School. This means that this study shows that the principal's attitude in making decisions is not in accordance with the teacher's expectations, causing teacher performance to decline.

Conclusion 4 are: organizational culture, work discipline, and leadership style simultaneously have a significant effect on teacher performance. It can be concluded that the

independent variable is able to affect the performance of teachers at the Tikung Lamongan Islamic Junior High School. This means that this is certainly inseparable from the role of the principal in making a meaningful contribution to teacher performance. Therefore, to improve teacher performance, school principals should try to implement participatory leadership behaviors, besides that school principals also need to improve their knowledge and skills about leadership, both on their own initiative and on the initiative of the city education office or other related parties.

SUGGESTIONS

Based on the results of the research and the results of the analysis that has been carried out by the researchers, this study still has many shortcomings, so there are still many things that need to be improved and considered for further researchers. Some suggestions need to be added for better research, including:

1. For the next researcher
 - a. It is hoped that further research can add and improve the questions of each indicator in this study, because the questionnaire used by the researcher is still limited and still inadequate.
 - b. It is hoped that further research will increase the number of samples so that the results obtained are even better from this study because in this study only 30 samples were used with distribution to 32 respondents.
 - c. It is hoped that further research will add other independent variables such as motivation and work environment to motivate teachers so that each teacher can maximize the results of the work carried out as well as work environment variables as a measure of each teacher being able to do their work in positive and conducive conditions.
2. For the object of research
For Tikung Lamongan Islamic Middle Schoolso that teacher performance remains high and maximum, the institution must maintain and always improve work discipline for teachers.

REFERENCES

- A, Davis. 2003. *Everything You Should Know About Public Relations. The Complete Guide to PR*. Jakarta: Gramedia.
- A. Mulyasa. 2003. *Competency-Based Curriculum*. Bandung: Youth Rosda Karya.
- AA Anwar Prabu Mangkunegara (2012). *Human Resource Management*. Bandung: PT. Rosdakarya Youth.
- AA Anwar Prabu Mangkunegara. (2001), *Human resource management company*, Bandung: Youth Rosdakarya.
- Adair, John. (2010). *Muhammad's leadership*. Jakarta: Gramedia Pustaka Utama.
- Adi Sulisty Nugroho. (2016). *E-Commerce Theory and Implementation*. Yogyakarta: EQUILIBRIA.
- Ahmad Susanto. (2016). *Learning and Learning Theory*. Jakarta: Prenada Media Group.
- Ahmad Susanto. (2016). *Learning and Learning Theory*. Jakarta: Prenada Media Group.
- Aisiyah, Nuraini and Susanto, Heri. 2010. *Analysis of the Influence of Leadership and Work Culture with Motivation as an Intervening Variable on Employee Performance at the Land Office of Kebumen Regency*. *Master's Journal*. No. 74. ISSN 0215-9511. National Land College. Yogyakarta.

- Andriani, AI2018. Profile of Non-Specific Bacteria in the Reproductive Tract of Dairy Cattle During Artificial Insemination at KUD Tani Wilis, Sendang District, Tulungagung Regency (Thesis). Faculty of Veterinary Medicine, Airlangga University.
- Arif, Thoha, (2005). The Influence of Principal Leadership, Professional Competence, and Teacher Work Motivation on Teacher Performance at SMP 1 Bangli. <https://arifthoha.files.wordpress.com>. Journal of social sciences volume 4. (accessed on Saturday, 20 June 2015).
- Asf, Jasmani & Syaiful Mustofa. 2013. Education Supervision: A New Breakthrough in Improving the Performance of School Supervisors and Teachers. Jokjakarta: Ar-Ruzz Media.
- Barnawi & M. Arifin. 2012 Management of School Facilities and Infrastructure. Yogyakarta: Ar-Ruzz Media.
- Barnawi. 2012. Mohammad Arifin. Professional Teacher Performance. Guidance, Improvement, and Research Instruments Jogjakarta: Ar-Ruzz Media.
- Brahmasari Ida Ayu, 2004. The Influence of Corporate Culture Variables on Employee Commitment and Company Performance The Jawa Pos Press Publishing Group, Accompanied by Airlangga University Surabaya.
- Cooper and Schindler. (2014). Bussiners Research Method. New York: McGrawHill.
- Dewi, Putu Yunita Saputri. Gede Adi Yuniarta., and Ananta Wikrama Tungga Atmaja. 2014. The Effect of Company Growth Capital Structure and Profitability on Firm Value. E-Jurnal S1 Ak Ganesha University of Education. Vol.2, No1.
- Djamarah, Syaiful Bahri. 2010. Teaching and Learning Strategy. Jakarta : Asdi Mahasatya.
- Erlina and Sri Mulyani, 2017, Business Research Methodology for Accounting and Management, First Issue, USU Press Publisher, Medan.
- Fahmi, Irham. 2018. Introduction to Financial Management. Bandung: Alphabeta
- Gaol, Jummy L. Human Capital Human Resource Management. 2014. Publisher PT. Gramedia Widiasarana Indonesia. Jakarta.
- Ghozali, Imam. 2005. Application of Multivariate Analysis with SPSS. Semarang: UNDIP Publishing Agency.
- Ghozali, Imam. 2013. Application of Multivariate Analysis with IBM SPSS 21 Update PLS Regression Program. Semarang: Diponegoro University Publishing Agency.
- Hariandja, Marihat Tua Efendi, 2002, "Human Resource Management", Grasindo, Jakarta.
- Hasibuan, Malay SP 2007, Human Resource Management Company, Bandung, PT. Aksa Earth.
- Hasibuan, Malay SP, 2004. Human Resource Management. Seventh Printing, Revised Edition, PT. Earth Literature. Jakarta.
- Hasibuan, Malay SP. (2014). Human Resource Management, Fourteenth Edition, Jakarta, Publisher: Bumi Aksara
- Jeine K. Turangan, 2017. The Effect of Compensation, Work Discipline and Professionalism on Teacher Performance at SMA Negeri 1 Manado, Emba Journal Vol.5 No.2
- M. Iqbal Hasan, 2002. Main Materials of Research Methodology and Its Applications. Ghalia Indonesia Publisher : Jakarta
- Made Pidarta. (2019). Indonesian Education Management. Jakarta: Renika Cipta.
- Martin, Mona. 2017. Nursing Care in Chronic Kidney Failure, : Faculty of Health Sciences UMP.
- Muhlisin, A. and Irdawati. (2010). Orem's Self Care Theory And Approaches In Nursing Practice. Journal of Nursing Science News, Vol. 2, No. 2, 97-100.
- Mustofa, Muchammad Arif. 2014. The Effect of Entrepreneurial Knowledge, Self Efficacy, and Entrepreneurial Character on Interest in Entrepreneurship in Class Xi Students of Smk Negeri 1 Depok, Sleman Regency. [Http:// eprints.uny.ac.id/.../1/SKRIPSI-](http://eprints.uny.ac.id/.../1/SKRIPSI-)

- MUCHAMMAD%20ARIF-10404244048- PEND.EKONOMI.pdf. (Accessed March 3, 2016).
- Priyono. 2016. Quantitative Research Methods. Sidoarjo: Zifatama Publishing.
- Rivai, vertikal (2004). Human Resource Management for companies from theory to practice. Jakarta: PR Raja Grafindo Persada.
- Robbin, Stephen P. And Mary Coulter. 2016. Management, Volume 1 Edition 13 Translated by: Bob Sabran and Devri Bardani P, Erlangga, Jakarta
- Robbins, Stephen P and Judge, Timothy A. (2013). Organizational Behavior. Edition 15. New Jersey: Pearson Education Limited.
- Rorimpandey, L. 2013. Transformational, Transactional, Situational, Service and Authentic Leadership Styles on the Performance of Village Employees in Bunaken District, Manado City. EMBA Journal. Vol. 1(4) :2233-2244. ISSN 2303-1174.
- Rorimpandey, L. 2013. Transformational, Transactional, Situational, Service and Authentic Leadership Styles on the Performance of Village Employees in Bunaken District, Manado City. EMBA Journal. Vol. 1(4) :2233-2244. ISSN 2303-1174.
- Samadi, B. 2013. Intensive Cultivation of Organic and Inorganic Kailan. Mina's library. Jakarta. 107 Pg .
- Sani, Ahmad & Vivin Maharani. 2013. Human Resource Management Research Methodology (Theory, Questionnaires and Data Analysis). Malang : UIN MALIKI Press. 2nd Printing.
- Santoso, Singgih. 2012. Parametric Statistics. Jakarta: PT Gramedia Public Library.
- Sedarmayanti, 2010, Human Resources and Work Productivity, second printing, publisher: Mandar Maju. Bandung.
- Sekaran, Uma, (2006), Research Methodology for Business Book 1 Edition 4, Jakarta: Salemba Empat
- Siagian, Sondang P, 2006. Human Resource Management, Thirteenth Edition, Bumi Aksara, Jakarta.
- Simamora, 1995. Human Resource Management, YKPN publishing division, Yogyakarta.
- Simamora, H., 1997, Human Resource Management, Edition 2, STIE YKPN, Yogyakarta.
- Singgih Santoso, 2014. SPSS 22 from Essential to Expert Skills, Gramedia member of IKAPI, Jakarta.
- Sondang P, Siagian. 2008. Human Resource Management. Jakarta : Earth Literacy.
- Stephen P. Robbins and Timothy A. Judge. 2008. Organizational Behavior Edition 12 Book 1. Translation: Diana Angelica, Ria Cahyani and Abdul Rosyid. Jakarta: Four Salemba.
- Sugiyono (2015). Combination Research Methods (Mix Methods). Bandung: Alfabeta.
- Sugiyono. 2010. Educational Research Methods Quantitative, Qualitative, and R&D Approaches. Bandung: Alfabeta.
- Sugiyono. (2009). Educational Research Methods Quantitative, Qualitative, and R&D Approaches. Bandung : Alfabeta.
- Sujarweni, V. Wiratna. 2015. Business and Economic Research Methodology, 33. Yogyakarta: Pustaka Baru Press.
- Supardi. 2014. Teacher Performance. Jakarta: PT Raja Grafindo Persada.
- Wirawan. 2015. Performance Evaluation of Human Resources Theory, Applications, and Research. Jakarta. Salemba Empat.
- Yukl, Gary. 2010. Leadership in Organizations (Fifth Edition). Translated: Budi Supriyanto. Jakarta: PT. Index.
- Yulizar. (2019). The Effect of Education and Training on Teacher Performance at SMPN 2 Bangkingan Kota. Encyclopedia Of Journals, 1(4), 127-132.

Creative Tourism Management Model After Covid -19, Betong District, Yala Province

Papon Budsayamarn
Yala Rajabhat University
Papon.b@yru.ac.th

Sarinya Jungjing
Sarinya.j@yru.ac.th

Ittichai Seadam
Ittichai@yru.ac.th

ABSTRACT

To study the level of factors affecting creative tourism decisions after Covid-19 crisis, Betong District, Yala Province by using a research methodology that combines both quantitative research and qualitative research. For the quantitative research, a survey research method was used to sample 384 tourists visiting Betong District, Yala Province. The research tools were questionnaires, data analysis using percentage, frequency, arithmetic mean, standard deviation, and One-Way ANOVA Analysis. And Qualitative research using in-depth interviews, tourism business entrepreneurs, relevant government agencies, and 15 people of academics. The results of the research at the level of factors affecting creative tourism decisions after the Covid-19 crisis, Betong District, Yala Province, found that the most physically demanding factor, followed by the need to feel safe with The S.D. value was .442 and statistically significant.

Keywords: *model, tourism management and creative*

BACKGROUND AND SIGNIFICANCE OF RESEARCH

The tourism industry is considered an important industry in the economic and social development of Thailand. Tourism is the most important source of income, the revenue from tourism industry derived in foreign currency contributes to the stability of the balance of payments. In addition, the tourism industry is also a catalyst for Economic expansion which leads to employment, job creation, income distribution and investment in many related businesses that are directly related to transportation, accommodation, food and tourism business and for indirect related part is the production of goods, etc. It can be seen that in many countries the tourism industry is an industry that is ranked 1-3 in the top 10 of the country's major industries. It is believed that the importance of tourism will increase in the future, as evidenced by the government's continuous promotion policy, as the tourism industry plays an important role in economic, social and political aspects.

Nowadays, tourism has expanded more widely. The purpose of tourism is not for business, immigration, or occupational activities, but it covers different types of tourism. The advancement of science and technology has made tourism different from the original objectives and methods of tourism that make it fast, comfortable and contributing to human learning in the experience of simple recreational activities and greatly expanding the country's economy. It has become an industry of tourism, production and service, sales and etc. Therefore, there are a lot of foreign currency and money in circulation in the country (Woraporn Chaikae, 2013).

Tourism is considered one of the hospitality industries in Thailand with high potential. There are a variety of tourist attractions, including natural attractions, historical sites, cultural and traditional attractions, which has different conditions in each region in terms of terrain and climate that create diversity and an alternative for tourists to choose to visit. It can attract more tourists, both Thai and foreigner to travel (Chanphen Lamlaksanakul, 2007), which will lead to the growth of the country's economy. On the other hand, Tourism development under the concept of sustainable tourism will lead to the development of utilities and facilities in tourist attractions to have a better quality of life for the local people. As well as helping to raise awareness among people to have feelings of love and cherish for their local tourism resources. This will lead to conservation, restoration and conscious use of natural resources. In addition, the traveling also opens the viewpoint for tourists to bring knowledge and experience from the trip to improve life in society as well (Chalit Santotharak, 2007).

The epidemic of Covid-19 has caused a sudden disappearance of tourism and export revenues, which are the country's main income. Small entrepreneurs lack capital and people lack purchasing power when these external factors cannot be as dependable as they once were, the recovery of the Thai economy had to return to strengthen the country in accordance with the national strategy. The solution is to build a solid foundation and change the Covid-19 crisis as an opportunity to build a local and community-based economy while spreading prosperity to the region in the 4 new economic corridors, to achieve sustainable growth through increasing agricultural production efficiency or adapting to large-scale agriculture and modern agriculture, value-added processing, food industry and bio-based economy BCG (Bio-Circular-Green) economy), as well as the development of tourism and high-quality creative services.

Therefore, the researcher is interested in studying the model of creative tourism management after the Covid-19 crisis in Betong District, Yala Province, in order to increase the potential of entrepreneurs, government agencies and communities to prepare for creative tourism management after Covid-19. This creates opportunities for the local and community-based economy.

OBJECTIVES

To study the level of factors affecting creative tourism decisions after the Covid-19 crisis, Betong District, Yala Province.

RESEARCH METHODOLOGY

The procedure includes details of research hypothesis, area studied, planning methodology, research methodology, and data collection methods.

1. To gather information, content obtained from the study of documents, research sample and interview to create a questionnaire on creative tourism management model after the COVID-19 crisis in Narathiwat Province.
2. Create a questionnaire based on the relevant concepts and theories and apply the revised questionnaire based on the recommendation to test tourists in Narathiwat for reliability using the tool.
3. Get qualified, to verify the accuracy of content, language and
4. Develop the question words to obtain a complete questionnaire and collect the actual data for 15 people, consisting of 5 tourism business operators, 5 government agencies, and 5 scholars.

Quantitative samples

1) Population

The population used in this research was an unknown number of tourists visiting Betong District, Yala Province.

2) Sample Group

The samples were selected by random sampling (Accidental sampling) with the following steps:

1. Determination of sample size according to Cochran (Cochran, 1977 cited in Teerawut Ekakul, 2000) with the following formula:

$$n = \frac{Z^2}{4e^2}$$

Where n = the desired sample size

p = proportion of traits interested in the population

e = the level of permissible sampling error

Z = Z value at confidence level or significance level

- If the 95% confidence level or the significance level 0.05 has a value of Z = 1.96

- If the 99% confidence level or the 0.01 significance level has a value of Z = 2.58

Substitute	n	=	$\frac{(1.96)^2}{4(0.5)^2}$
	n	=	$\frac{(1.96)^2}{4(0.0025)}$
	n	=	384.16

In this study, the researcher collected data from a total sample of 384 people.

2. Random sampling, because the researcher does not know the differences in the population, therefore, the researcher has randomly sampled (Accidental sampling) until the required number is complete.

Qualitative sampling

The researcher assigned a qualitative sample of 15 people to conduct a Focus Group Discussion.

Method of random sampling

Sampling without using probability theory (Non-probability Selection Sampling) by using a specific selection method (Purposive Selection) which can be divided as follows:

5 tourism business entrepreneurs

5 relevant government agencies and

5 scholars

The people selected as a sample group in the group discussion were those who were directly involved in tourism management after the Covid-19 crisis, Betong District, Yala Province.

SUMMARY RESULTS AND DISCUSSION

Personal Information

The results of research on personal factors of 384 tourists in Betong District, Yala Province were as follows:

Gender, the majority of the samples was 203 females, representing 52.7% and 181 males, representing 47.3%.

Age, most of the samples were 31-40 years old, 138 people representing 35.9%, followed by 20-30 years old, 103 people representing 26.8 %, 41-50 years old, 88 people representing 22.9%, 51-60 years old, 34 people representing 8.9 %, and over 60 years old, 21 people representing 5.5 %.

Income, most sample groups have monthly income of 15,001-20,000 baht, 207 people representing 53.9%, followed by monthly income of 10,000-15,000 baht, 82 people representing 21.4 %, more than 30,000 baht, 39 people representing 10.5 %, 20,001-25,000 baht, 37 people representing 9.6 %, and 25,001-30,000 baht, 18 people representing 4.7 %.

Occupation, most of the sample groups were private employees, 177 people representing 46.1 %, followed by private business careers, 68 people representing 17.7%, students of 49 people representing 12.8%, trade of 42 people representing 10.9%, government service of 30 people representing 7.8 % and other 18 people representing 4.7 %.

The time of travel, most of the sample group chooses during public holidays to travel, 180 people representing a percentage, followed by choosing the weekend time to travel, 151 people representing 39.3% and for weekdays, 53 people representing 13.8 %.

Accommodation, most of the respondents chose a resort as accommodation of 191 people representing 49.7%, followed by a homestay, 85 people representing 22.2%, hotel, 57 people representing 14.8% and relative/friend house, 51 people representing 13.3%.

Amount of money spent on tourism, most of the samples spent on tourism per time 2,001-2,500 baht, 119 people representing 31.0%, followed by spending on tourism per time 2,501-3,000 baht, 114 people representing 29.7%. More than 3,000 baht, 63 people representing 16.3%, 1,501-2,000 baht, 54 people representing 14.1% and below 1,500 baht, 34 people representing 8.9%.

Level of Factors Affecting Creative Tourism Decisions after the Covid-19 Crisis, Betong District, Yala Province

Table 1: Research results at the level of factors affecting creative tourism decisions after the Covid-19 crisis, Betong District, Yala Province.

n = 384			
Factors Affecting Creative Tourism Decisions After the Covid-19 Crisis	\bar{X}	S.D.	Interpret
In terms of physical needs	4.41	.396	highest
The need to feel safe	4.28	.609	highest
Accommodation and attractions	4.03	.572	high
Economic Aspect	4.04	.919	high
Legal Aspect	4.18	.602	high
Factors affecting all aspects of creative tourism decisions after the COVID-19 crisis	4.19	.442	high

Table 1, the level of research results of factors affecting creative tourism decisions after the Covid-19 crisis, Betong District, Yala Province, found that it was at a high level. It was 4.19

and the S.D. was .442, with physical demand being the highest with 4.41 and S.D. of .396. The need to feel safe was at the second level with 4.28 and the S.D. was .609 and the legal aspect is in the third level, with a value of 4.18 and an S.D. of .602. For economic aspect, it was at the fourth level with 4.04 and the S.D. was .919, and the accommodation and attractions were at the last level, with a value of 4.03 and a value of S.D. equal to .572 when considered separately as follows:

Table 2 Research results at the level of factors affecting creative tourism decisions after the Covid-19 crisis, Betong District, Yala Province, “Physical Needs”

n = 384

The level of factors affecting travel decisions	Comment Level					\bar{X}	S.D.	Interpret
	Extremely high	High	Moderate	Low	Extremely low			
1. Travel to visit Betong after Covid-19 to need a rest	235 (61.2)	135 (35.1)	8 (2.1)	0 (0.0)	6 (1.6)	4.54	.692	Extremely high
2. Travel to Betong after Covid-19 to change the atmosphere from staying home	163 (42.5)	207 (53.9)	14 (3.6)	0 (0.0)	0 (0.0)	4.39	.558	Extremely high
3. Travel to visit Betong after Covid-19 to find new experiences exciting	163 (42.5)	193 (50.2)	26 (6.8)	0 (0.0)	2 (0.5)	4.34	.651	Extremely high
4. Travel to Betong after Covid-19 to escape from everyday life	198 (51.6)	148 (38.5)	36 (9.4)	2 (0.5)	0 (0.0)	4.41	.680	Extremely high
5. Travel to Betong after Covid-19 experiencing new cultures	200 (52.1)	134 (34.9)	48 (12.5)	2 (0.5)	0 (0.0)	4.39	.721	Extremely high

“Physical needs” Total		4.41	.396	Extremely high
-------------------------------	--	-------------	-------------	-----------------------

Table 2 Research results at the level of factors affecting creative tourism decisions after the Covid-19, Betong District, Yala Province found that the “physical needs” factor was the highest, with a value of 4.14 when interpreted as the highest level and the S.D. value of .396 when considering each item, the tourists in Betong District, Yala Province, there was an opinion level of factors of physical needs as follows: the highest level of opinion was to travel to Betong after Covid-19 to need a rest (= 4.54, S.D. = .692), travel to Betong after Covid-19 to escape from daily life (= 4.41, S.D. = .680), travel to Betong after Covid-19 in order to change the atmosphere from staying at home (= 4.39, S.D. = .558), Travel to Betong after Covid-19 to experiencing new cultures (= 4.39, S.D. = .721) and travel to Betong after Covid-19 to find new experiences exciting (= 4.34, S.D. = .651).

Table 3 Research results at the level of factors affecting creative tourism decisions after the Covid-19 crisis, Betong District, Yala Province, in terms of “Need to feel safe”.

n = 384

The level of factors affecting travel decisions	Comment Level					\bar{X}	S.D.	Interpret
	Extremely high	High	Moderate	Low	Extremely low			
1. Safety, hygiene during travel to Betong during Covid-19 affects your travel decision	235 (61.2)	135 (35.1)	8 (2.1)	0 (0.0)	6 (1.6)	4.36	2.191	Extremely high
2. Protecting yourself and your family while traveling in Betong during Covid-19 is an important factor in travel decisions	163 (42.5)	207 (53.9)	14 (3.6)	0 (0.0)	0 (0.0)	4.26	.737	Extremely high
3. Decided to go to Betong always thinking about how to travel safely from Covid-19	235 (61.2)	135 (35.1)	8 (2.1)	0 (0.0)	6 (1.6)	4.13	.744	High

4. Pay attention to cleanliness and hygiene in Betong tourism during Covid-19	163 (42.5)	207 (53.9)	14 (3.6)	0 (0.0)	0 (0.0)	4.29	.689	Extremely high
5. There is no more important factor than cleanliness and hygiene in Betong tourism during Covid-19	163 (42.5)	207 (53.9)	14 (3.6)	0 (0.0)	0 (0.0)	4.34	.679	Extremely high
“Needs to feel safe” Total		4.28	.609	Extremely high				

Table 3 The results of research on the level of factors affecting creative tourism decisions after the Covid-19 crisis, Betong District, Yala Province found that the “need to feel safe” factor ranked second, with \bar{X} a value of 4.28 when interpreted at the highest level and an S.D. of .609. However, when considering each aspect, it was shown that tourists in Betong District, Yala Province had the following levels of opinions on the need to feel safe as follows: think of Safety Hygiene during travel to Betong during the Covid-19 affects their travel decision ($\bar{X} = 4.36$, S.D. = 2.191), there is no more important factor than maintaining cleanliness and hygiene in Betong tourism during Covid-19 ($\bar{X} = 4.34$, S.D. = .679), pay attention to cleanliness and health in Betong tourism during Covid-19 ($\bar{X} = 4.29$, S.D. = .689), keeping yourself and your family safe during travel to Betong during Covid-19 is an important factor in travel decisions ($\bar{X} = 4.26$, S.D. = .737) and there are opinions at a high level that is “Decided to go to Betong always thinking about how to travel safely from Covid-19” ($\bar{X} = 4.13$, S.D. = .744).

Table 4 Research results at the level of factors affecting creative tourism decisions after the COVID-19 crisis, Betong District, Yala Province, in terms of “Legal”

n = 384

The level of factors affecting travel decisions	Comment Level					\bar{X}	S.D.	Interpret
	Extremely high	High	Moderate	Low	Extremely low			
1. Decided to travel to Betong after Covid-19 because there are	156 (40.5)	178 (46.2)	45 (11.7)	5 (1.6)	0 (1.6)	4.26	.721	Extremely high

strict laws to prevent the risk of the spread of Covid - 19								
2. The curfew law forbidding people from leaving their homes between 10 PM-4AM affects their decision to travel to Betong after Covid-19	173 (44.9)	149 (38.7)	55 (14.3)	7 (2.1)	0 (0.0)	4.26	.779	Extremely high
3. Airspace closure laws, international flight bans to reduce the spread of Covid-19 affect your decision to travel to Betong after Covid-19	200 (51.9)	133 (34.5)	40 (10.4)	7 (2.1)	4 (1.0)	4.34	.827	Extremely high
4. Clear penalties for people who hide their illnesses, causing the spread of the COVID-19 virus affect your decision to travel to Betong after Covid-19	137 (35.6)	138 (35.8)	62 (16.1)	15 (4.2)	32 (8.3)	3.86	1.190	High
“Legal” Total		4.18	.602	high				

Table 4 The results of research findings at the level of factors affecting creative tourism decisions after the Covid-19 crisis, Betong District, Yala Province, found that the “legal” factor was ranked third with \bar{X} a value of 4.18 and the S.D. value was .602. When considering each item, it was found that tourists in Betong District, Yala Province, had the following levels of opinion of legal factors: There are opinions at the extremely high level, including Airspace closure laws, international flying bans to reduce the spread of COVID-19 affect your decision to travel to Betong after Covid-19 ($\bar{X} = 4.34$, S.D. = .827), Decided to travel to Betong after COVID-19 because there are strict laws to prevent the risk of the spread of COVID-19 ($\bar{X} = 4.26$, S.D. = .721). The curfew law forbidding people from leaving their homes between 10PM - 4AM affects their decision to travel to Betong after Covid-19 ($\bar{X} = 4.26$, S.D. = .779) and there were opinions at a high level such as, clear penalties for people who hide their illnesses, causing the spread of the Covid-19 virus affect your decision to travel to Betong after Covid-19 ($\bar{X} = 3.86$, S.D. = 1.190)

Table 5 Research results at the level of factors affecting creative tourism decisions after the Covid-19 crisis, Betong District, Yala Province, in terms of “Economic”.

n = 384

The level of factors affecting travel decisions	Comment Level					\bar{X}	S.D.	Interpret
	Extremely high	High	Moderate	Low	Extremely low			
1. Travel to Betong after Covid-19 due to government policies that help stimulate the tourism economy	126 (32.7)	142 (36.9)	39 (10.1)	35 (9.1)	42 (11.2)	3.71	1.310	high
2. Travel to Betong after Covid-19 because the government helps support accommodation costs 40% of the price of accommodation per room, per	137 (35.6)	140 (36.4)	61 (15.8)	14 (3.6)	32 (8.6)	3.87	1.191	high

night, not exceeding than 3,000 baht, the project of "We travel together"								
3. Travel to Betong after Covid-19 because the government helps support airfare equal to 40 % of the ticket price but not more than 2,000 baht per passenger in the "We Travel Together" project	153 (39.7)	186 (48.4)	34 (8.8)	8 (2.1)	4 (1.0)	4.24	.780	Extremely high
4. Travel to Betong after Covid-19 due to the government helps to support food discount coupons 900 or 600 baht per room per night for those who check-in at hotels in the "We Travel Together" project	143 (37.1)	191 (49.6)	48 (12.8)	0 (0.0)	2 (0.5)	4.34	2.144	Extremely high
" Economic " Total						4.04	.909	high

Table 5 The results of research on the level of factors affecting creative tourism decisions after the Covid-19 crisis, Betong District, Yala Province shown that the "economic"

factor ranked fourth with \bar{X} a value of 4.08 when interpreted as high level and S.D. of .909. When considering each item, it was found that tourists in Betong District, Yala Province had the opinions of economic factors as follows: there are opinions at extremely high level, including Decided to travel to Betong after Covid-19 due to the government helps to support food discount coupons 900 or 600 baht per room per night for those who check-in at hotels in the “We Travel Together” project ($\bar{X} = 4.34$, S.D. = 2.144), for decided to travel to Betong after Covid-19 because the government helped support airfare equal to 40 % of the ticket price but not more than 2,000 baht per passenger in the "We Travel Together" project ($\bar{X} = 4.24$, S.D. = .780) and there are opinions at a high level, namely, the post-COVID-19 decision because the government helps support accommodation cost at 40% of the price of accommodation per room per night, not exceeding 3,000 baht in the "We Travel Together" project ($\bar{X} = 3.87$, S.D. = 1.191) and for travel to Betong after COVID-19 due to government policies that help stimulate the tourism economy ($\bar{X} = 3.71$, S.D. = 1.310).

Table 6 Research results at the level of factors affecting creative tourism decisions after the Covid-19 crisis, Betong District, Yala Province, in terms of “Accommodation and Tourist Attractions”

n = 384

The level of factors affecting travel decisions	Comment Level					\bar{X}	S.D.	Interpret
	Extremely high	High	Moderate	Low	Extremely low			
1. Travel to Betong after Covid-19 because accommodation and tourist attractions are free from the epidemic of Covid-19	126 (32.7)	142 (36.9)	39 (10.1)	35 (9.1)	42 (11.2)	4.25	.668	Extremely high
2. Travel to Betong after Covid-19 because accommodation and attractions are worth the money	137 (35.6)	140 (36.4)	61 (15.8)	14 (3.6)	32 (8.6)	4.04	.801	high
3. Traveling to Betong after Covid-19,	137 (35.6)	140 (36.4)	61 (15.8)	14 (3.6)	32 (8.6)	4.06	.849	high

accommodation and tourist attractions are easily accessible destinations								
4. Travel to Betong after Covid-19 because the attractions are interesting	137 (35.6)	140 (36.4)	61 (15.8)	14 (3.6)	32 (8.6)	3.93	1.050	high
5. Travel to Betong after Covid-19 because the accommodation is comfortable	137 (35.6)	140 (36.4)	61 (15.8)	14 (3.6)	32 (8.6)	3.87	1.205	high
“Accommodation and attractions” Total						4.03	.572	high

Table 6 The results of research at the level of factors affecting creative tourism decisions after the Covid-19 crisis, Betong District, Yala Province found that the “accommodation and tourist attraction” factor was in the last order with \bar{X} a value of 4.03. After interpreting the results, it was at a high level and the S.D. value was .572. When considering each item, it was found that tourists in Betong District, Yala Province have the opinion level of factors in terms of accommodation and tourist attractions as follows: the extremely high level of opinions is traveling to Betong after Covid-19 because accommodation and tourist attractions are free from the epidemic of Covid-19 ($\bar{X} = 4.25$, S.D. = .668) and there are opinions at a high level, including traveling to Betong after Covid-19, accommodation and tourist attractions are easy to reach, convenient to travel ($\bar{X} = 4.06$, S.D. = .849), for travel to Betong after COVID-19 accommodation and tourist attractions are easily accessible destinations ($\bar{X} = 4.04$, S.D. = .801), follow by travel to Betong after COVID-19 because the attractions are interesting ($\bar{X} = 3.93$, S.D. = 1.050), and travel to Betong after COVID-19 because the accommodation is comfortable ($\bar{X} = 3.87$, S.D. = 1.205).

SUGGESTIONS

The researcher has the following recommendations:

1. Government agencies and private sectors involved in tourism should develop standards of service, cleanliness and hygiene. Standard service price, honest towards travelers and colleague. It should have a consciousness of being a good host, supervise the safety, and service personnel must understand the culture of tourist. Communication must be able to communicate with tourists understandably and must focus on the communication of information to tourists via the Internet.
2. Most tourists travel on weekends and during the annual vacation. Therefore, relevant agencies must have a work plan to prepare and support, such as personnel, equipment, tools and vehicles, etc.
3. There should be a study of tourism behavior and factors affecting the decision to travel in other provinces, in order to compare and connect tourism in each region. As well as, to support the ever-changing tourism behavior and be able to study further or develop a tourism marketing strategy.
4. There should be a study of community development guidelines for sustainable community tourism that combines local wisdom, community landscape, and modern technology. In this regard, relevant government and private agencies should promote and support the development of tourism models in order to create sustainable connection for community tourism to the international markets.

REFERENCE

- Woraporn Chaikee.(2014). The satisfaction of foreign tourists towards visiting Si Satchanalai Historical Park, Sukhothai Province. Srinakharinwirot University.
- Chanpen Lamlaksanakul.(2007) Factors influencing the number of Thai tourists traveling abroad. Independent study, Bachelor of Economics program (Business Economics), Kasetsart University.
- Chalit Santithararak.(2007). Forecasting the number of foreign tourists coming to Thailand by the Areema method. Independent study report, Master of Economics. University of Chiang Mai.
- Theerawut Ekakul.(2000). Research Methods in Behavioral Sciences and Social Sciences. Ubon Ratchathani: Ubon Ratchathani Rajabhat Institute.

An Investigation on Graduates' Written Discourse for Social Intelligence: A Discourse Analysis on Job Application Documents

Muhammad Nadzrin Khairuddin
Universiti Tun Hussein Onn Malaysia
hl210004@siswa.uthm.edu.my

Mimi Nahariah Azwani Mohamed
Universiti Tun Hussein Onn Malaysia
azwani@uthm.edu.my

ABSTRACT

There is an increase in the unemployment rate involving Malaysian fresh graduates every year. One of the main reasons highlighted by employers is graduates' lack of communication skills. When applying for jobs, fresh graduates need to produce job application documents such as cover letters and resumes. However, it has been reported that the cover letters and resumes that these fresh graduates produce are not effective. The language used in the documents have not captured the interests of the recruiters to shortlist them for a job interview. Their inability to connect with the recruiters through their written discourse can be associated with the lack of social intelligence. The preliminary study aims to investigate recruiters' perceptions of the language used cover letters and resumes produced by fresh graduates. The study also identifies features of the language used by fresh graduates in their job application documents that serve as the basis for the recruiters to shortlist them for job interviews. This study employs qualitative research design. One recruiter is invited to participate in this preliminary study. A think aloud protocol is employed to investigate the recruiter's perceptions of the language used in cover letters and resumes produced by fresh graduates. The data obtained from the think aloud protocol is analysed through discourse analysis. The findings show that the cover letter and resumes lack evidence of social intelligence and the language used is not able to persuade the recruiter to shortlist the applicant for a job interview.

Keywords: *Discourse analysis; social intelligence; written discourse; cover letters; resumes.*

INTRODUCTION

During the last few years, the number of graduates is increasing, so does unemployment. In 2021, the number of graduates in Malaysia increased by 4.7% to record 5.61 million from the previous year of 5.36 million graduates (Department of Statistics Malaysia, 2022). The number of unemployed graduates rose to 197,400 in 2021 compared to 165,200 unemployed graduates in 2019. According to Aina (2017), the World Bank said a high percent of jobless youth contributes to the overall unemployment in Malaysia, and this includes fresh graduates. Gao et al. (2017) found that excellent graduates were unable to secure good positions during their job search because of the discrepancy between the job information that these graduates received in college and the actual demands of the market.

In this evolving decade, employers are looking for graduates with high level of social intelligence, as it is believed those individuals can create good relationship among colleagues while providing excellent commitment and performance in the workplace by making critical decisions (Alkozei et al., 2016 & Tamunosiki-Amadi et al., 2020). It is an important aspect of employment among graduates, as majority of graduates who did not meet the required social intelligence and soft skills competencies are filtered out and have lower chances of being employed (Jameson et al., 2016). Employers nowadays are not only looking for academic

achievements and qualifications from graduates, but they also demanded good communication and interpersonal skills from them to ensure the companies advances gradually ahead of their competitors. (Afifah & Razli, 2019). But these key skills required by employers, namely social intelligence, are where fresh graduates fall short of (Noah & Aziz, 2020). It is an obvious yet not straightforward matter as multiple industry specialist can identify the different level of social intelligence graduates possessed, in the way they presented their job application documents, and it helps employers to recognize potential candidates for their company (Bassah, 2022). Majority of employers agreed that social intelligence is one of the main components that employers are looking for, and it is noticeable through their writings in job application documents. With this, fresh graduates should pay more attention towards preparing solid job application documents to ease their hiring process.

However, graduates are deemed as not prepared to enter the industry as they did not develop the necessary qualities that employers are looking for (Meeks; 2017, Suleman & Laranjeiro; 2018). Few employers had pointed out that graduates' communication skills are lacking in the context of job application. The worrying part about their communication skills in producing their job application documents are the fact that it affects their employment in the future if graduates and stakeholder ignore this issue. There are multiple aspects recruiters look for in those documents, and one of it is the language and the choice of words that are inappropriate to present themselves as a suitable candidate for the job (Rahman et al., 2020). Krishnan et al. (2017) stated that fresh graduates are clearly struggling in producing sentences when communicating. Grammatical errors, unsuitable choice of vocabulary, inadequate information and vague statements when applying for jobs are a constant battle that recruiters are facing, as those qualities are the opposite of what companies are looking for. This could be caused by the absence of social intelligence, without denying the possibility of limited proficiency among fresh graduates (Husain et al., 2017; NST Education, 2019). For instance, Sakran (2018) reveals that graduates are struggling when preparing letter and applying for their internship. Their structured application letters are cluttered and messy, and it is the result of being ignorant to the requirements of the company rather than their language competencies. The integration of additional unrelated information towards the company's requirement proved the absence of social intelligence among these graduates and gives the idea of the utilization of pre-written application document by graduates (Wijayanti, 2020). In addition, the research added that not all graduates provided a detailed description of their competencies and skills related to the job specification. This deficiency and lack of information can be caused by the written competency and expertise, and also the graduates' self-confidence.

Some may believe that job application documents such as resumes does not matter that much, if that particular candidate possessed the relevant skills with them. But the existence of spelling mistakes in one's job application documents has the same damaging impact on the chances of being shortlisted for an interview (Martin-Lacroux et al., 2018). Some managers emphasized that graduates focus more on introducing themselves while unable to demonstrate their credentials in their job application documents (Mello et al., 2021). This raise concerns on their job application documents, as successful application letter should exhibit a purpose in conveying their message to the recruiters in a professional context (Debbie, 2016). Even though graduates are not yet being employed in a professional environment, they are required to prepare good job application documents to appeal to their desired job. Not only graduates, but professionals who have been in the industry for quite some time also encounter the similar obstacles when preparing and constructing their application, which usually caused by having lower social intelligence (David, 2017). Another statement by Mohamed et al. (2017) mentioned that both fresh graduates and professional job applicants have limited vocabulary in

the English language, which create difficulties for them to convey their intended meaning and information in their documents. If the situation of graduates incapacities on displaying their social intelligence through job application documents remain as it is, it can subsequently hinder them from being employed and subsequently increases the unemployment rate in the country.

SOCIAL INTELLIGENCE THEORY

According to Kong (2015), social intelligence assist and enhance a person's understanding towards other people's thoughts by employing relevant social approach in order to adapt, interact, and making their way in social environment. This is similar according to Goswami (2018), as it involves being conscious and sensitive towards people's emotions, feelings, and way of thinking, while making use of social cues to act according to their surroundings. It is also an expansion on a previous concept of emotional intelligence. Social intelligence is adhered to the communication and interaction aspects of interpersonal relation (Subramaniam et al., 2019). In connection with that, social skills are traits that people exhibit. They include the capacity to talk clearly and persuasively, which requires saying the correct thing at the right moment. It entails the development of positive connection with others, acting appropriately around one another, handling issues without demeaning other people, and quickly resolving disputes through negotiation and management (Mohamed, 2020). A person who possessed high social intelligence and experienced in social situations can greatly understand other people, and it allows them to manage their actions according to the social situations (Koraus et al., 2017). Recruiters believed that candidates with sociable personality are possibly talented candidates for their company (Kabalina & Osipova, 2021). According to Goswami (2022), the higher the social intelligence one's possessed, the higher their ability to understand and analyse other people's feelings, emotions, thoughts, and actions. Therefore, graduates with high social intelligence are highly demanded as having good communication and interpersonal skills indicates their ability to work well in the company.

A theory of social intelligence that relates to this research is proposed by Karl Albrecht (2006), who differentiate five elements of communication under the scope of social intelligence. He categorized 5 components of social intelligence into one model, S.P.A.C.E. The acronym S.P.A.C.E stands for Situational Awareness, Presence, Authenticity, Clarity, Empathy. The former highlights the ability of an individual to perceive their social situations that enables them to perform appropriate action on an appropriate setting. Next, Presence is the attitude someone portrays themselves to the public and properly convey their personalities consistently, regardless of what the circumstance are. Actions who's unmatched with the personality indicates an absence of Presence in an individual. Authenticity on the other hand, is the degree to which someone is perceived as being honest and ethical, depending on how authentic or real they are. Clarity supports the competency of graduates in delivering clear messages that fit the purpose to avoid misinterpretations, while Empathy highlights the skills of being empathise towards other people's situations in order to approach and relates to them. The theory developed by Karl Albrecht (2006) is the basis of this research that features components regarding graduates' language use in their job application documents such as building rapport and a relationship with the recruiters, being mindful of the context of their writing, using the right words to prevent misunderstanding, and being ethical and truthful when submitting their applications.

Social Intelligence in Written Communication

Other than verbal communication, written communication is one way to see one's social intelligence competency. Communication itself is the knowledge sharing between one individual to another (Batur et al., 2019). The process of communication involves an equal reciprocation between the sender and receiver (Gürüz & Eğinli, 2017). As mentioned, there is also a clear and straight constructive relationship between social intelligence and communication skills (Uygun & Aribas, 2020). To support the previous statement in connection with social intelligence and communication, Al-Ayoub et al., (2022) also identified a fair positive connection between both social intelligence and communication skills, whereby it underlines that communication skills an individual possess might be affected by social intelligence. A study conducted by Maskur et al. (2020) indicated that a person's social intelligence level can have a direct or indirect impact on almost a quarter of written communication. For example, Prabavathi (2018) mentioned those who are familiar with the feelings and ideas of their intended audience can plan and write in a way that is consistent with the message's goals to gain something from the communication. In this case, graduates can identify the requirements needed in a particular company and make full use of their job application documents to be seen as potential candidate. Graduates must remember to use clear words and sentences while communicating through this medium in order to allow transparency and avoid conveying the wrong messages, as written communication has the drawback of being inadequate in terms of tone and response (Prabavathi, 2018).

Graduates Job Application Documents

The cover letter or other job application document serves as a recruiter's link to the attached resume, which is a personal statement of the applicant's qualifications and employment background (Thumnong & Tongpoon-patanasorn, 2017). According to Piopiunik et al. (2020), graduates from colleges who exhibit strong social skills and mental capacity are more likely to be invited for an interview. Contrarily, a generic, uninteresting, typo-filled cover letter will raise the likelihood that the application will be rejected frequently, permanently preventing the applicant from entering a prospective dream position in the company (Tomaska & Nosek, 2018). It is discovered that graduates' cover letters and resumes still lack persuasion and are ambiguous and often lacking in detail when expressing the relevant information (Wijayanti, 2020). This preliminary research covers two types of graduates' job application documents, their cover letter and resume. In this study, cover letter and resume can be seen as a document to understand fresh graduates' social intelligence level that are portrayed in their job application documents during their application towards the respective recruiters.

Cover Letter

The written communications are often what people see first. Similar with cover letter, this document is usually prepared in a single compact page. The contents comprise of introduction, the messages that can reach the target audience, along with the closing statement by the writer. The cover letter provides a window of opportunity for applicant to create a connection by showcasing their knowledge about the company or the targeted industry. It allows individuals to highlight their competencies, interest, and experiences related to the applied position, and definitely demonstrate their expertise and competency regarding their written communication (Dolan, 2016). Mello et al. (2021) reveals that all graduates in the study never miss to provide their personal details in the introductory section, and always end the cover letter with good and positive closure.

Resume

As written documents can generally be seen first by companies and industries, applicant needs to prepare a focused job application documents to capture the attention of their recruiter. The standard application material for job seekers nowadays is still a resume (Catano, 2016). Job applicants can choose whether to make their personal information, career objectives, academic success, professional experiences, and accolades available to recruiters (Risavy, 2017). To catch the recruiters' attention, most job applicants utilise various fonts, formats, colours, tables, and other personalised stuff (Chen, 2018). The resume must also be user-friendly since they serve as marketing tools to elevate the qualifications, qualities, and achievements of applicants (Dolan, 2016). Written materials might act as a reminder because an interview or meeting leaves a lasting image of the applicant. Thus, applicants might prepare a resume that stood out from the rest of the applicant to ensure a strategic influence on the shortlisting process

METHOD

This research utilized the qualitative approach to gather the preliminary data. This research uses the qualitative approach as it is considered as the appropriate method to obtain data to achieve the research objectives. Yin (2018) encourages the use of a qualitative method to gain understanding of events that happen in a particular place or to a particular group or person. There are three different forms of interviews: organised, semi-structured, and unstructured. This study uses interviews to gather pertinent data based on real-life phenomena (Jamshed, 2014; Edwards & Holland, 2013; Stuckey, 2013). A semi-structured interview session is conducted with one recruiter from a public company, who has experienced 17 years as an engineer, and a recruiter in charge of hiring new candidates for the past seven years. A Think-Aloud Protocol is implemented as well, which provides samples of students' resume and cover letter during the interview session in order to probe the respondent regarding their first impression on those documents. The data received from the respondent is then transcribed and analysed via discourse analysis. The frequency in which a topic or phrase is stated by respondents provides insight into its significance. Themes will then be ranked in order of importance.

RESULTS

The results focus on two areas: the respondent's impression of graduates' language use and the language characteristics employed by fresh graduates in their job application documents that helps recruiters to shortlist them for interviews. The findings also adhere to Karl Albrecht's S.P.A.C.E model, namely Situational Awareness, Presence, Authenticity, Clarity, Empathy.

Recruiters' Perceptions of The Language Used in Job Application Documents Produced by Graduates

One of the most repeated phrases regarding recruiters' perception on graduates' job application documents are the use of grammar by the graduates. Findings indicate that graduates are critically weak in terms of their grammar usage such as spelling, formats, titles, and sentence structure. These mistakes are identified as fatal by the respondent, which parallel from previous research. According to the respondent, the idea of proofreading one's document is necessary before submitting, to utilize their cover letter and resume to its full potential. Based on Karl Albrecht's social intelligence theory, this situation strengthens his S.P.A.C.E model where graduates are unable to illustrate their 'Situational Awareness' towards the companies' hiring

requirements. The way graduates present their documents with frequent grammatical errors are key indicator that they are not well-prepared to take up roles in working with the company, as mentioned by the respondent. With too many grammatical errors, graduates are not able to being persuasive towards the respondent when preparing their documents. Secondly, graduates are also found to have the inclination to self-rate their own competencies and put their own standards and strengths on their skills. The word usage such as “expert” in certain language, a “specialist” in a particular role, are labelled as groundless by the respondent as they are unjustified and not backed by factual statistics and data. By making such controversial statements, the respondent tend to question the ‘Presence’ aspect in the S.P.A.C.E model, where graduates actions and skills are inconsistent with their ability to fulfil the requirements. Other than that, another major perception that recruiters have on graduates’ language used are the redundant and unclear information written in their documents. Personal details and the use of jargons opens up conflict of misunderstanding with the respondents. They have tendencies to list down their activities without any description, which confuses the respondent in analysing the documents. The respondent also mentioned that “If he (candidates) jumbles up all the skills in one box for recruiters to pick, this action might turn also off some employers”. Graduates seems to include every skills that they can fir in the documents, which made it hard for recruiters to identify. In this case, graduates are showing their deficiency in the ‘Clarity’ aspect in delivering precise and appropriate messages to prevent misunderstandings towards the respondent.

Table 1. Recruiters’ perceptions of graduate’s language used in job application documents

No	Ranking
1	Produce a lot of grammatical errors
2	Self-rate their own skills and competencies
3	Unclear and inadequate information

Characteristics of Graduates' Language in Job Application Documents That Helps with Shortlisting Process

Any information in graduates’ job application documents is analysed by recruiters to ensure they can understand the candidates well before hiring them. The language basis that recruiters are looking for in filtering graduates job application documents are the values and contributions these graduates can portray in their cover letter and resume. It can initiate new conversation and recruiters’ interest to know more about the candidates. According to the respondent, the values and contributions are not necessarily on how much sales a graduates can make, but rather any process that is shorten, any damages that could be prevented, and any complaints that can be reduced. Next, the respondent is highly keen on looking out for cover letter and resumes that highlighted the top skills relevant to the post that graduates apply, which according to the respondent, will spark interest and initiate more conversation with the recruiter. Graduates’ top skills are considered as essential in job application documents to differentiate one candidate from another, and helps recruiter finalize their decision. The respondent mentioned that graduates should list their top skills 3 – 5 skills they possessed, that matches with the company’s need in order to develop and scale their competency further. During the interview process, the respondent explores and inquires more on the graduates’ experiences regarding the listed skills, to ensure the ‘Authenticity’ of the statement and whether they are being honest and ethical in listing their competencies. However, if graduates failed to state their skills, it can be due to their incompetencies in writing, and does not necessarily mean they do not possess that quality and values. Based on the respondent, it is an added points if graduates list down their achievement related to the skills to prove the authenticity. The final

features that help graduates being shortlisted are additional assessments and certificates from third party attached to their documents, which indicates that they are properly evaluated. As mentioned above, the respondent has high demand for factual data. As any evaluation from third party removes biased, it is considered as a strong pillar in the resume and cover letter. These are the top features that the respondent discloses in the process of hiring and shortlisting candidates for job employment opportunity.

Table 2. Features of the language used by fresh graduates in their job application documents that serve as the basis for the recruiters to shortlist them for job interviews

No	Ranking
1	Values and contributions that candidates have to offer
2	Top skills and contributions that are relevant to the job
3	Additional assessments and certificates as credentials

DISCUSSION

This preliminary research explores the presence of social intelligence in graduates' job application documents via the social intelligence theory by Karl Albrecht. Out of the five components of S.P.A.C.E model, only 'Empathy' is nowhere to be found and assessed by the respondent which strengthens the relevance of this model. Other than that, an interesting subject emerge during the data analysis, which is gender bias, as the respondent mentioned that different applicant genders can affect the decision making of recruiters throughout the hiring process. A simple personal information such as gender might trigger a bias from the recruiter, considering the companies are looking for specific type of individuals and genders might be one of them. Future research should be done to broader range of industrial sectors on a wider sample to further test the relevance of Karl Albrecht model, while incorporating the gender component to it. This preliminary research is hopefully able to aid future graduates to express key element on what is needed by the industry and recruiters in order to prepare themselves for the industry and reduce unemployment in the country as a whole.

ACKNOWLEDGMENT

This research was supported by Ministry of Higher Education (MOHE) through Fundamental Research Grant Scheme (FRGS/1/2021/SS0/UTHM/02/3). We also want to thank to the Government of Malaysia which provide MyBrain15 programme for sponsoring this work under the self-funded research grant and L00022 from Ministry of Science, Technology and Innovation (MOSTI).

REFERENCES

- Afifah, H. P., & Razli, C. R. (2019). Perspective of Asian Employers on Graduates' Soft Skills: A Systematic Review. *Universal Journal of Educational Research*, 7(11), 2397-2405.
- Aina, N. (2017) *More than 1.7 million foreign workers in Malaysia; majority from Indonesia*. *The New Straits Time*. Retrieved from: <https://www.nst.com.my/news/nation/2017/07/261418/more-17-million-foreign-workersmalaysia-majority-indonesia>
- Al-Ayoub, Z., Eliwah, S., Al-Garalleh, F. (2022) Social Intelligence and its Relationship with Communication Skills Among Physical Education Students at Jordanian Universities. *Educational Sciences*, 49(1), 283–298.
- Albrecht, K. (2006). *Social Intelligence: The New Science of Success*.

- Alkozei, A., Zachary, S. J., Killgore, W. D. S. (2016). *Journal of Nonverbal Behavior*, 40, 39-54.
- Bassah, N. A. S. H. (2022). The Issues and Challenges of TVET in Malaysia: From the Perspective of Industry Experts. *18(1)*.
- Batur, Z., Başar, M., Şener, N. and Uygun, K. (2019). The examination on communication and dissenting disputes in different nationalities' students. *Kastamonu Education Journal*, 27 (6), 2781-2794
- Catano, V. M., Wiesner, W. H., & Hackett, R. D. (2016). Recruitment and selection in Canada. Chen, J., Zhang, C., Niu, Z. (2018). A Two-step Resume Information Extraction Algorithm. *Mathematical Problems in Engineering*. 1-8.
- David, P. (2017). Assembling the Application. *Chronicle of Higher Education*, 63 (34). 3-4.
- Debbie, G. E. H. (2016) Thematic Options and Success in ESL Writing: An analysis of promotional texts. *Text-Based Research and Teaching*. 281-304.
- Department of Statistics Malaysia, 2022.
- Dolan, R. (2016) Branding yourself effective communication skills. *FEMS Microbiology Letters*, 364(2).
- Edwards, R., & Holland, J. (2013). What is Qualitative Interviewing?
- Gao, Y., Ng, J. C. Y., Ding, L. (2017) The Influence of Information Disparity, Discrimination and Geographic Location On Job Search Outcome: Does Good Academic Performance Helps Outstanding Graduates Find “Good Job”? *Journal of Arts, Science & Commerce*, 8(2). 45-51.
- Goswami, M. (2018). Assessing the social intelligence of service sector employees in India. *Indian Journal of Industrial Relations*. 53 (4), 693-706.
- Gürüz, D., & Temel Eğinli, A. (2017). *Kişilerarası iletişim*. Ankara: Nobel Yayıncılık.
- Husain, M., Kumar, C. S., & Saritha, G. (2017). Role of the Teacher of English: Enhancing Employability Skills to Engineering Students. *International Journal of Engineering Technology Science and Research*, 4(12). 1120-1124.
- Jameson, A., Carthy, A., McGuinness, C., & McCweeney, F. (2016). Emotional intelligence and graduates - employers' perspectives. *Social and Behavioural Sciences*, 228, 515-522.
- Jamshed, S. (2014). Qualitative Research Method-interviewing and Observation. *Journal of Basic and Clinical Pharmacy*, 5(4), 87-88.
- Kabalina, V. & Osipova, A. (2021) Identifying and assessing talent potential for future needs of a company. *Journal of Management Development*, 41(3), 147-162
- Kong, E. (2015). A qualitative analysis of social intelligence in non-profit organizations: External knowledge acquisition for human capital development, organizational learning and innovation. *Knowledge Management Research & Practice*, 13, 463–474.
- Korauš, A., Kašćáková, Z., Parová, V., & Veselovská, S. (2017). Sustainable economic development through human resource management: Social intelligence of managers and performance. *Journal of Security and Sustainability Issues*, 6(3), 457-478.
- Krishnan, I. A., Ching, H. S., Ramalingam, S., & Maruthai, E. (2017). An Investigation of Communication Skills Required by Employers from the Fresh Graduates. *Pertanika Journal of Social Sciences & Humanities*, 27(2).
- Martin-Lacroux, C., Muller, B., Reymond, D. (2018). Do Employers Forgive Applicants' Bad Spelling in Résumés? *Business and Professional Communication Quarterly*, 80(3), 321–335.
- Maskur, Tola, B. Akbar, M. (2020). The Effect of the Students' Learning Independence, Social Intelligence, and English Reading Skills on Their Writing Skills of English Recount Text. *Indonesian Journal of Educational Review*. 7(1). 39-49.

- Meeks, G., A. (2017) Critical Soft Skills to Achieve Success in the Workplace. *Walden Dissertations and Doctoral Studies*.
- Mello, G. D., Krishnan, I. A., Arumugam, N., Ibrahim, M. N. A., Ma'mor, M. S. H., Ramalingam, S. (2021) Schematic analysis of job application letters by Malaysian graduates. *Australian Journal of Career Development 2021*, 30(1). 72–79.
- Mohamed, E. S. A. (2020). The impact of social intelligence and employees' collective self-efficacy on service provider's performance in the Egyptian governmental hospitals. *International Journal of Disruptive Innovation in Government*, 1(1), 58-80.
- Mohamed, N., Halim, N. S., Husin, N., Mokhta, N. (2017) An Analysis of Promotional Genre In Job Application Letters. 6(1). 58 – 69.
- Noah, J. B. & Aziz, A. A. (2020) A Systematic review on soft skills development among university graduates. *Journal of Social Science*, 6(1). 53-68.
- NST Education. (2019). Preparing Undergraduates for the Workplace. New Straits Times.
- Piopiunik, M., Schwert, G., Simon, L., Woessmann, L. (2020). Skills, signals, and employability: An experimental investigation. *European Economic Review*. 1-25.
- Prabavathi, R. & Nagasubramani, P. C. (2018). Effective and Oral Communication. *Journal of Applied and Advanced Research*. 3(1). 29-32.
- Rahman, F., Mohamed, A. H., Nasir, N. S. A., & Saidin, K. (2020). Exploring Perceptions of Employers on Communication Skills Among Fresh Graduates. *Practitioner Research*, 1. 69-85.
- Risavy, S. D. (2017). The Resume Research Literature: Where Have We Been and Where Should We Go Next? *Journal of Education and Developmental Psychology*, 7(1).
- Sakran, T. M. (2018). Engineering Internship Ads Informing the Teaching of Writing of Internship Application Letters (IALs). *Journal of Teaching and Teacher Education*. 6(2). 135-147.
- Stuckey, H. L. (2013). Three Types of Interviews: Qualitative Research Methods in Social Health. *Journal of Social Health and Diabetes*, 1(2), 56-59.
- Subramaniam, N., Kansal, M., Mihret, D.G. and Babu, S. (2019). Outsourcing mandated corporate social responsibility in India: risks and performance. *Journal of Accounting and Organizational Change*, 15(3), 453-472.
- Suleman, F. & Laranjeiro, A. M. C. (2018) The employability skills of graduates and employers' options in Portugal. An explorative study of anticipative and remedial strategies. *Education and Training*, 60(9), 1097-1111.
- Tamunosiki-Amadi, J. O., Sele, G. D., & Ernest, O. E. (2020). Social Intelligence and Employee Commitment in Bayelsa State Health Sector. *International Journal of Business and Social Science*. 11(2). 68-76.
- Thumnong, P. & Tongpoon-patanasorn, A. (2017) A genre analysis of job application letters written by ASEAN applicants.
- Tomaska, L. & Nosek, J. (2018) Ten simple rules for writing a cover letter to accompany a job application for an academic position. *PLoS Computational Biology*, 14(5). 1-4.
- Uygun, K. & Aribas, B.B. (2020). Examining the Relationship between Social Intelligence Levels and Communication Skills of Prospective Social Studies Teachers. *Educational Policy Analysis and Strategic Research*, 15(1), 232-252.
- Wijayanti, S. H. (2020) How Indonesian Students Write Job Application Letter. *Advances in Social Science, Education and Humanities Research*, 585. 680-685.
- Yin, R. K. (2018). Case Study Research and Applications: Design and Methods.

The Effects of Work Motivation, Organizational Culture, and Work Environment on Employee Performance Through Work Discipline Mediation Variables at PT. Suma Samudra Mandiri

Badri Syarif

Universitas Nahdlatul Ulama Surabaya
syariefbadri@gmail.com

Ubaidillah Zuhdi

Universitas Nahdlatul Ulama Surabaya
ubaidillah.zuhdi@unusa.ac.id

ABSTRACT

PT Suma Samudra Mandiri is a company engaged in the construction and building sector which was established in 2014. The company was founded by Mr. Suyitno who also serves as the company's president director, until now. The location of this company is located on Jl. Sidorejo No. 34 Pakal Surabaya City. PT Suma Samudra Mandiri itself is establishing and maintaining good partner relationships with various government and private companies on a national scale in the construction and building sector. PT Suma Samudra Mandiri has developed quite rapidly, so PT Suma Samudra Mandiri is determined to develop its business to become more concentrated and innovative. Therefore, it takes a high commitment from employees to the work life of PT Suma Samudra Mandiri to achieve a goal. Human Resources (HR) is a science that studies a process of planning, organizing, controlling, developing, and leadership to achieve a predetermined organizational/company goal. This process functions in the field of staffing, because human resources are considered very important in achieving company goals. By providing work motivation, form a good work culture, and provide a pleasant work environment, with the hope that employees can increase employee productivity more optimally and optimally. Thus, various surveys and analyzes were carried out systematically. From the results of observations made, it does not show an appropriate picture at all because there are still some employees who are less enthusiastic and disciplined at work, this means that there is a gap between company expectations and employee performance. With this research, I want to prove that whether or not a company will achieve its goals by encouragement of work motivation, organizational culture, and work environment that affect employee performance through the mediation of work discipline in this study.

Keywords: *work motivation, organizational culture, work environment, employee performance, work discipline*

INTRODUCTION

In Indonesia, there are many companies engaged in construction and building, one of which is PT Suma Samudra Mandiri, a company engaged in construction and building that was founded in 2014. This company was founded by Mr. Suyitno who also serves as president director of the company, to date. The location of this company is located on Jl. Sidorejo No. 34 Pakal Surabaya City. To date, we have established and maintained good partnership relationships with many national-scale government and private companies in the construction and building sector. PT Suma Samudra Mandiri has grown quite rapidly. With a variety of experience and professionalism at PT Suma Samudra Mandiri in the field of equipment, facilities and infrastructure are handled by experienced workers / employees in this field. Definitely PT. Suma Samudra Mandiri is determined to develop its business to become more concentrated and innovative. Therefore, it takes a high commitment from employees to the working life of

PT. Suma Samudra Mandiri. This research is motivated by the phenomenon of decreasing employee performance that occurs at PT. Suma Samudra Mandiri so that this problem must be immediately addressed by the company's leadership. According to Simamora (2004), employee performance is the level of work or work achieved by employees according to the requirements that have been determined by the organization or company within a certain time. Based on several things that were complained by company employees, such as the provision of work motivation, organizational culture, work environment, and work discipline are factors that indicate problems with the performance of employees of PT. Suma Samudra Mandiri. Motivation is a willingness to expend a high level of effort towards organizational or company goals to meet an individual need. According to Hasibuan & Silvy (2019), work motivation is a person's encouragement to work, for example, a large salary, a nurturing leader, adequate work facilities, a comfortable work environment and pleasant co-workers and others. Organizational culture itself is a system of shared meanings or meanings held by its members that distinguishes an organization from other organizations (Darmawan, 2013). In addition to organizational culture, there are other variables that affect employee performance, namely the work environment. According to Sunyoto (2012), it means that the work environment is a very important component part for employees in carrying out their work activities. And the last variable is the work discipline variable where if this variable is managed properly it can result in employee compliance with various company regulations that aim at the productivity of an employee. According to Hasibuan (2012), discipline is the awareness and willingness of an employee to obey all company regulations and applicable social values. So someone will be willing to obey the rules and carry out his duties, both forced and voluntarily. This is evidenced by data obtained from companies that do not show the achievement of employee performance in accordance with the company's SOP targets, while the company's targets must be achieved by employees at least 40 building projects every month, this is because there are still some employees who lack passion and discipline in work.

So various surveys and analyzes that are carried out systematically are called research. In this case, improving employee performance is expected to be able to provide maximum service so that the goals or success of a company can be achieved. To achieve this, several factors are needed that can affect the achievement of performance, which consist of work motivation, organizational culture, work environment and work discipline. With this research, I want to prove whether a company will achieve its goals with the encouragement of work motivation, organizational culture, and work environment that will affect employee performance through the mediating variable of work discipline. In the research title: The effect of work motivation, organizational culture & work environment on employee performance through the mediating variable of work discipline at PT. Suma Samudra Mandiri.

METHODS

According to Sujarweni (2015) quantitative research is a type of research that produces findings that can be obtained using statistical procedures. Referring to the problem formulation and research objectives that have been set in the previous chapter, the type of research that will be used is research using quantitative methods to test and prove the hypothesis that has been made through the results of testing and data processing. The data collection method that will be used in this study is to use a questionnaire. Questionnaires are written and pre-formulated questions in which respondents will record their answers. The answer is usually close to a certain choice according to Sekaran (2010) in (Agung). The data processing method in this research is the structural equation modeling (SEM) model equation. SEM modeling is the development of path analysis, in the SEM method the causality relationship between exogenous and

endogenous variables can be determined more completely (Abdullah, 2015) In this study, the researcher used the population as a sample. In this study the number of samples used were 39 employees of PT. Suma Samudra Mandiri which consists of male and female sexes.

HYPOTHESIS TEST

This study will use a significant value of 0.05 or 5% alpha. The relationship between variables can be said to be significant if the P value is smaller than the predetermined significant value ($P < 0.05$). The following are the P values obtained in this study:

Table 1. Hypothesis Testing

Hypothesis	Variable	Original Sample (O)	Standard Deviation (STDEV)	T Statistics (O/STDEV)	P Values
H1	WM=>EP	0,082	0,081	1,011	0,313
H2	OC=>EP	0,071	0,081	0,884	0,377
H3	WE=>EP	0,528	0,090	5,873	0,000
H4	WD=>EP	0,202	0,099	2,038	0,042
H5	WM=>WD=>EP	0,123	0,062	1,975	0,049
H6	OC=>WD=>EP	0,448	0,064	6,952	0,000
H7	WE=>WD=>EP	0,357	0,061	5,873	0,000

Hypothesis 1 (It is suspected that there is a significant effect of work motivation on employee performance partially) Based on the test results shown in table 4.5, it shows that work motivation has no significant effect on employee performance. This result is strengthened by showing the value of Tstatistic < 1.96 , which is $1.011 < 1.96$. This means that H1 is rejected.

Hypothesis 2 (It is suspected that there is a significant influence of Organizational Culture on Employee Performance partially) Based on the test results shown in table 4.5, it shows that organizational culture has no significant effect on employee performance. This result is strengthened by showing the value of Tstatistic < 1.96 , which is $0.884 < 1.96$. This means that H2 is rejected.

Hypothesis 3 (It is suspected that there is a significant effect of the Work Environment on Employee Performance partially) Based on the test results shown in table 4.5, it shows that the work environment has a significant influence on employee performance. This result is strengthened by showing the value of Tstatistic < 1.96 , which is $5.873 < 1.96$. This means that H3 is accepted.

Hypothesis 4 (It is suspected that there is a significant effect of Work Discipline on Employee Performance partially) Based on the test results shown in table 4.5, it shows that work discipline has a significant influence on employee performance. This result is strengthened by showing the value of Tstatistic < 1.96 , which is $2.038 < 1.96$. This means that H4 is accepted.

Hypothesis 5 (It is suspected that the direct influence of work motivation on employee performance through work discipline is greater than the indirect effect) Based on the test results shown in table 4.5, it shows that work motivation has a significant influence

on employee performance through work discipline. This result is strengthened by showing the value of Tstatistic <1.96 which is $1.975 < 1.96$. This means that H5 is accepted.

Hypothesis 6 (It is suspected that the direct influence of Organizational Culture on Employee Performance through Work Discipline is greater than the indirect effect)

Based on the test results shown in table 4.5, it shows that organizational culture has a significant influence on employee performance through work discipline. This result is strengthened by showing the value of Tstatistic <1.96 , which is $6.952 < 1.96$. This means that H6 is accepted.

Hypothesis 7 (It is suspected that the direct influence of the Work Environment on Employee Performance through Work Discipline is greater than the indirect effect)

Based on the test results shown in table 4.5, it shows that the work environment has a significant influence on employee performance through work discipline. This result is strengthened by showing the value of Tstatistic <1.96 , which is $5.873 < 1.96$. This means that H7 is accepted.

CONCLUSIONS

Based on the results of research that has been carried out with the title The Effect of Work Motivation, Organizational Culture, and Work Environment on Employee Performance Through Work Discipline Variables at PT. Suma Samudra Mandiri, the following conclusions have been found:

Conclusion 1, namely work motivation has no significant effect on employee performance. This means that H1 is rejected because work motivation has no significant effect on employee performance. This study shows that the lack of work motivation provided by the company has a negative impact on employee performance. Then the motivation to work in the company should be considered again so that employee performance is maximized.

Conclusion 2, namely organizational culture has no significant effect on employee performance. This means that H2 is rejected because organizational culture has no significant effect on employee performance. Refers to the existing fact that there is employee dissatisfaction seen from active and constructive actions in expressing opinions to make changes to the company system that will occur. Suggestions or requests are submitted openly, through joint deliberation, but there is a lack of follow-up steps in solving problems from some employees or have not received optimal resolution steps from the company. Therefore, employees assess, the weakness of the company's organizational culture can affect the quality of performance.

Conclusion 3, namely the work environment has a significant effect on employee performance. This means that H3 is accepted because the work environment has a significant effect on employee performance. This means that there is a positive and significant influence between the work environment on employee performance. This explains that the work environment in a company can affect employee work productivity, so to increase it the company must have a conducive work environment.

Conclusion 4, namely work discipline has a significant effect on employee performance. This can be interpreted that H4 is accepted because work discipline has a significant effect on employee performance. This means that there is a positive and significant influence between work discipline on employee performance. This explains that the higher the work discipline possessed by the employee, the higher the employee's performance.

Conclusion 5, namely work motivation has a significant effect on employee performance through work discipline. This can be interpreted that H5 is accepted because work motivation has a significant effect on employee performance through work discipline. This means that there is a positive and significant influence between work motivation on employee performance through work discipline. This means that if the work motivation of employees is getting better, it will improve employee performance through work discipline.

Conclusion 6, namely organizational culture has a significant effect on employee performance through work discipline. This can be interpreted that H6 is accepted because organizational culture has a significant effect on employee performance through work discipline. This means that there is a positive and significant influence between organizational culture on employee performance through work discipline. This means that if the organizational culture applied by the company is good, it will improve employee performance through work discipline in the company.

Conclusion 7, namely the work environment has a significant effect on employee performance through work discipline. This means that H7 is accepted because the work environment has a significant effect on employee performance through work discipline. This means that there is a positive and significant influence between organizational culture on employee performance through work discipline. This means that a comfortable, safe, clean work environment will make employees feel at home at work and focus on doing a job according to a predetermined time.

SUGGESTIONS

Based on the results of the research data analysis above, there are some suggestions for PT. Suma Samudra Mandiri, which are as follows:

1. For PT. Suma Samudra Mandiri and related parties are expected to pay more attention to employee performance, employee responsibilities, and pay attention to the rights and obligations that employees are entitled to, such as salaries, holiday allowances, K3 guarantees, career paths, and responsible supervisors.
2. Company leaders are advised to be able to create a more conducive organizational culture so that the aspirations of employees can be heard by all leaders, in order to improve employee performance more optimally.
3. For further research, it is expected to be able to analyze the research more deeply, by looking at some of the latest variables so that it can produce more complex analysis or results.

REFERENCES

- Brahmasari, I. A., & Siregar, P. (2009). Pengaruh budaya organisasi, kepemimpinan situasional dan pola komunikasi terhadap disiplin kerja dan kinerja karyawan pada PT Central Proteinaprima TBK. *Jurnal Aplikasi Manajemen*, 7(1), 238-250.
- Budianto, A.A.T., & Katini, A. (2015). Pengaruh Lingkungan Kerja Terhadap Kinerja Pegawai Pada PT. Perusahaan Gas Negara (Persero) Tbk SBU Distribusi Wilayah I Jakarta. *Jurnal Ilmiah Prodi Manajemen Universitas Pamulang*, 3(1).
- Budiman, A. S. (2021). Pengaruh Lingkungan Kerja Dan Semangat Kerja Terhadap Disiplin Kerja Karyawan (Studi Pada Alfamart)

- Budiono, D. S. (2016). Pengaruh Budaya Organisasi terhadap Kinerja Karyawan melalui Komitmen Organisasi sebagai Variabel Intervening pada PT. Kerta Rajasa Raya. *Jurnal Riset Ekonomi Dan Manajemen*, 16(1), 29-43.
- Darmawan, Didit. (2013). *Prinsip-Prinsip Perilaku Organisasi*. Surabaya : Pena Semesta. Dessler.
- Dewi, A. F. (2019). Pengaruh Kompensasi, Pengembangan Karier, Lingkungan Kerja, Dan Budaya Organisasi Terhadap Disiplin Kerja Karyawan Pada Pt. Gresik Cipta Sejahtera Cabang
- Dharma, S. dan Akib, H. (2005). *Manajemen Kinerja*. Jakarta: Pustaka Pelajar.
- Dharmawan, Yusa. 2011. Pengaruh Kompensasi dan Lingkungan Kerja Non Fisik Terhadap Disiplin dan Kinerja Karyawan Hotel Nikki Denpasar. Tesis.
- Dharmawan, Yusa. 2011. Pengaruh Kompensasi dan Lingkungan Kerja Non Fisik Terhadap Disiplin dan Kinerja Karyawan Hotel Nikki Denpasar. Tesis. Universitas Udayana Denpasar. Bali
- Faida, Eka Wilda. 2019. *Manajemen Sumber Daya Manusia Dan Ergonomi Unit Kerja Rekam Medis*. Sidoarjo: Indomedia Pustaka.
- Fajari, A. H. (2021). PENGARUH GAYA KEPEMIMPINAN DAN BUDAYA ORGANISASI TERHADAP KINERJA KARYAWAN MELALUI KEPUASAN
- Gary, (2006), *Manajemen Sumber Daya Manusia (terj.)*, Edisi Kesepuluh Jilid 1,
- Gouzali, S. (2000). *Manajemen Sumber Daya Manusia (Human Resources Management): Suatu Pendekatan Mikro (Dalam Tanya Jawab)*. Djembatan.
- Gusnamawati, R. (2018). Pengaruh Disiplin Kerja terhadap Prestasi Kerja Karyawan pada PT. Perintis Perlindungan Instalasi Listrik Nasional (PPILN) Area Kabupaten Bandung (Doctoral dissertation, PERPUSTAKAAN).
- Hasibuan, J. S., & Silvya, B. (2019). Pengaruh Disiplin Kerja dan Motivasi Terhadap Kinerja Karyawan. *Prosiding Seminar Nasional Multidisiplin Ilmu*, 134–147.
- Hasibuan, M. S. . (2012). *Manajemen Sumber Daya Manusia*. Jakarta: Bumi Aksara. Jakarta: Indeks.
- KERJA SEBAGAI VARIABEL INTERVENING (Studi Kasus Pada PT. Mustika Ratu Buana International Surabaya) (Doctoral dissertation, Universitas Muhammadiyah Malang).
- KORWIL LENEK, LOMBOK TIMUR). e-Repository Sarjana FEB Universitas Gajayana Malang.
- MEDAN. *Accumulated Journal (Accounting and Management Research Edition)*, 1(2), 131-141.
- Simamora, Henry, (2004), *Manajemen Sumber Daya Manusia*, Yogyakarta: STIE YKPN.
- Sunyoto, Danang. (2012). *Manajemen Sumber Daya Manusia*. Cetakan Pertama. Jakarta : Penerbit PT Caps.
- Sujarweni, V. Wiratna. 2015. *Akuntansi Manajemen*. Yogyakarta : Pustaka Baru Press.
- Sekaran, Uma & Bougie, Roger. (2010). *Research Methods for Bussines: A Skill Bulding Approach-5th ed*. United Kingdom: A John Wiley and Son, Ltd, Publication.

Demographic Characteristic of Gamification in Malaysia

Wan Hashridz Rizal bin Wan Abu Bakar
Faculty of Islamic Studies,
Sultan Ahmad Shah Pahang Islamic University (UnIPSAS)
rizal@unipsas.edu.my

Zuraini binti Mohamad
Faculty of Management and Informatics,
Sultan Ahmad Shah Pahang Islamic University (UnIPSAS)
zuraini@unipsas.edu.my

Nur Aulia Fahada binti Misaridin
Faculty of Management and Informatics,
Sultan Ahmad Shah Pahang Islamic University (UnIPSAS)
fahada@unipsas.edu.my

ABSTRACT

Recently, gamification has received attention as a powerful user engagement tool with application in online education. Presence of Kahoot and Quizizz, which are simple to set up and apply to a variety of subjects, lecturers can easily incorporate game elements into their lessons. Based on the probability sampling method, this quantitative study was conducted among lecturers in Pahang private university, and the data collected came from as many as 76 respondents. Based on descriptive statistics, the research's findings demonstrate that women made up 57.9 percent of the study's respondents. 42.1% of the respondents to this research, or the majority, are aged between 31 and 40. Those with a Master's Degree make up the majority of respondents (69.7%) in terms of educational level. Respondent with an experience more than 10 years made up 48.7%. In term of gamification apps that has been used in teaching and learning 41.5% respondents is not using any application in their class.

Keywords: Gamification, Education, Gamification Apps.

ABSTRAK

Pada masa kini, gamifikasi telah mendapat perhatian sebagai kaedah pengajaran baru dalam pendidikan atas talian. Aplikasi seperti Kahoot dan Quizizz, merupakan aplikasi yang sering digunakan untuk pelbagai mata pelajaran, pensyarah dengan mudah dapat memasukkan elemen permainan ke dalam pelajaran mereka. Berdasarkan kaedah persampelan kebarangkalian, kajian kuantitatif ini dijalankan di dalam kalangan pensyarah universiti swasta Pahang, dan data yang dikumpul adalah daripada seramai 76 orang responden. Berdasarkan statistik deskriptif, dapatan kajian menunjukkan 57.9 peratus daripada responden kajian adalah wanita. 42.1% daripada responden penyelidikan berumur antara 31 dan 40. Mereka yang mempunyai Ijazah Sarjana membentuk majoriti responden (69.7%) dari segi tahap pendidikan. Responden yang mempunyai pengalaman lebih daripada 10 tahun sebanyak 48.7%. Dari segi aplikasi gamifikasi yang telah digunakan dalam pengajaran dan pembelajaran 41.5% responden tidak menggunakan sebarang aplikasi dalam kelas mereka.

Kata kunci: Gamifikasi, Pendidikan, Aplikasi gamifikasi.

INTRODUCTION

The emergence of Covid-19 has made significant impact on the Education industry. Following the impact of Covid-19, the government has decided to impose a lockdown. From there, the

education industry in the country changed, with educators and institutions beginning to conduct online classes. In Malaysia, the education sector has begun to use e-learning. Many educational institutions are looking for the best ways to deliver course materials online, engage students, and conduct evaluations. To increase student engagement, educators have used e-learning tools such as e-books, video conferencing, and games. Gamification has recently been recognised as an effective user engagement tool with applications in online education. Kahoot and Quizizz are two applications that can be easily configured and used in a variety of subjects, allowing for the incorporation of game elements into classrooms with minimal effort.

LITERATURE REVIEW

There are several studies that investigated the gamification in education. Gamification is an educational approach that aims to motivate and influence students' learning behaviours in order to achieve learning outcomes. (Aries et al., 2020). According to Hu, (2020) gamification not only makes learning more interesting, but it also allows game players to solve problems and learn lessons through failure and success. This "positive failure" can inspire students to take on a challenging mission. Study by Legaki et al., (2020) stated that gamification is increasingly being used in educational settings to increase student motivation and, as a result, learning outcomes. Past research by Ouariachi et al., (2020) clearly show that education is a critical component in responding to the threat of climate change, not only increasing knowledge but also encouraging changes in attitudes and behaviours toward adopting sustainable lifestyles. Scholars and practitioners in the field of education are calling for new ways to engage youth, which is why gamification has gained popularity in recent years. Lavoué et al., (2019) findings support the importance of modifying gaming features to increase learner engagement and provide guidance on how to implement adaptation mechanisms. Past research study by Çeker & Özdamli, (2017) show the number of educators and researchers worldwide who are researching and attempting to benefit from gamification applications in a variety of disciplines is growing. Some of these disciplines (such as chemistry, health, etc) appear to be benefiting and succeeding more than others in their project states. Despite the constraints they face when using this technology, the results by Ismiyani, (2020) show that educators have positive attitudes toward Kahoot. To summarise, Kahoot is a fun assessing tool that makes learning interactive, fun, and enjoyable. Najjar & Salhab, (2022) research state educator believe that gamification engages learners, motivates them to learn, meets their needs, and transfers knowledge through enjoyable tasks. Mylonas et al., (2021) findings, supported by evaluation data and responses from 30 educators in Greece and Italy, confirm that incorporating competition and gamification aspects can significantly increase student engagement, particularly when groups/schools compete against each other. Points, Quizzes, and Challenges are the most commonly used game elements. The findings also reveal that the primary reasons for not implementing the resources are a lack of knowledge, a lack of information about relevant games for teaching software engineering, and a lack of time to plan and implement these approaches in the classroom. Ultimately, the results indicate that the software engineering professors are likely to adopt these game-related approaches in the future (Rodrigues et al., 2019)

METHODOLOGY

This study aims to identify the active role in explaining the intention to use gamification among lecturers in Pahang Private University. The instrument used in this study was adapted from previous studies. The scale used is a Likert scale starting from 1 'strongly disagree' up to 5 'strongly agree'. We chose this scale based on the norms used by social scientist as can be seen

in the study of (Kalkbrenner, 2021). The sampling method used in this study was probability sampling. We chose this sampling because we have a sampling frame. According to Krejci and Morgan Table, a total of 80 respondents should be involved in this study but only 76 respondents answering the survey. To meet the rules and regulations during MCO, this study was conducted through a face-to-face survey and an online platform. We used Google form as a platform to distribute questionnaires. We have completed a complete questionnaire in an Excel worksheet for the purpose of filtering invalid data.

DATA ANALYSIS

Demographic characteristics of the respondents are as follows: Among the total no. of respondents, there were 30 males (39.5%) and 44 (57.9%) females. Most of the respondents were between 31 and 40 age groups (42.1%) and remaining 32.9% were 41-50 age group. A majority of respondents earned a master (53%), followed by degree (12%) and PhD (11.8%). In term of experience in higher education (48.7%) respondents have more than 10 years experiences followed by the more than 5 years experiences with (18.4%). (65.8%) respondent have more than 5 years' experience in this private university and then (21.1%) have worked at this private university for more than two years. Permanent employees (67.1%) outnumber contract employees (32.9%). In comparison, (53.9%) of respondents have experience using gamification in teaching and learning, while (46.1%) have no experience. Quizizz and Kahoot are the most popular among respondents (26.8% and 24.4%, respectively). (41.5%) are not using Gamification apps in teaching and learning. See

Table 2.

Table 2. Demographic Table

Variable		Frequency	Percentage
Age	26-30	11	14.5
	31-40	32	42.1
	41-50	25	32.9
	51 and above	6	7.9
Gender	Male	30	39.5
	Female	44	57.9
Education Level	Degree	12	15.8
	Master	53	69.7
	PhD	9	11.8
Experience in higher Education	More than 1 year	10	13.2
	More than 3 years	12	15.8
	More than 5 years	14	18.4
	More than 10 years	37	48.7
	Less than 1 year	2	2.6
Experience in this private university	Less than 1 year	5	6.6
	More than 1 year	5	6.6
	More than 2 years	16	21.1
	More than 5 years	50	65.8
Employment Status	Contract	25	32.9
	Permanent	51	67.1
Academic Administrator Position	Vice chancellor and Deputy vice Chancellor	3	3.9

	Dean	2	2.6	
	Associate Dean	1	1.3	
	Centre Director	3	3.9	
	Head of Department	9	11.8	
	None	45	59.2	
	Others	13	17.1	
Department	Dakwah	11	14.5	
	Quran and sunnah	10	13.2	
	Syariah and Laws	9	11.8	
	Education and Human Development	9	11.8	
	Arabic Language	11	14.5	
	English Language	6	7.9	
	Foundation Studies	2	2.6	
	Creative Multimedia and Computing	8	10.5	
	Business	5	6.6	
	Finance	2	2.6	
	Accounting	3	3.9	
	Experience of using gamification in teaching and learning	Yes	41	53.9
		No	35	46.1
Gamification apps that has been used in teaching and learning	Kahoot	20	24.4%	
	Mentimeter	1	1.2%	
	Quizizz	22	26.8%	
	None	34	41.5%	
	Others	5	6.1%	
Valid N (listwise)		76	100%	

DISCUSSION

There have been several prior studies that also looked at gamification in education, as was mentioned in the literature review section. Quizizz and Kahoot are the gamification apps that users use the most, according to the study's results. These results also demonstrate the rise in popularity of gamification in recent years. As can be seen, more than half of respondents at the private university in Pahang used gamification apps in their classes. The results of this study are consistent with those of the cross-sectional study carried out by Abdeen & Albiladi, (2021) which found that gamification, also known as game-based learning, is gaining popularity in educational institutions, where it is used to promote training, help students develop their problem-solving abilities, and improve the learning process. However, these results need to be carefully examined because there are some things that could be done better, particularly in terms of sampling. Despite the use of probability sampling, 4 out of the 80 respondents who were required to respond to the questionnaire did not do so, making it impossible to generalise the results of this study to the entire population.

REFERENCES

Journal article:

Abdeen, F. H., & Albiladi, W. (2021). Gamification and Technology-Based Learning: Uncovering the Potential of Using Games in Language Teaching and Learning. *Journal of Studies in Education*. <https://doi.org/10.5296/jse.v11i2.18339>

- Çeker, E., & Özdamli, F. (2017). What “gamification” is and what it’s not. *European Journal of Contemporary Education*. <https://doi.org/10.13187/ejced.2017.2.221>
- Hu, J. (2020). Gamification in Learning and Education: Enjoy Learning Like Gaming. *British Journal of Educational Studies*. <https://doi.org/10.1080/00071005.2019.1682276>
- Ismiyani, N. (2020). The perceptions of educators for gamification approach: The effectiveness of kahoot in teaching english. *Asian EFL Journal*.
- Kalkbrenner, M. T. (2021). A practical guide to instrument development and score validation in the social sciences: The MEASURE Approach. *Practical Assessment, Research, and Evaluation*, 26(1), 1.
- Lavoué, É., Monterrat, B., Desmarais, M., & George, S. (2019). Adaptive Gamification for Learning Environments. *IEEE Transactions on Learning Technologies*. <https://doi.org/10.1109/TLT.2018.2823710>
- Legaki, N. Z., Xi, N., Hamari, J., Karpouzis, K., & Assimakopoulos, V. (2020). The effect of challenge-based gamification on learning: An experiment in the context of statistics education. *International Journal of Human Computer Studies*. <https://doi.org/10.1016/j.ijhcs.2020.102496>
- Mylonas, G., Paganelli, F., Cuffaro, G., Nesi, I., & Karantzis, D. (2021). Using gamification and IoT-based educational tools towards energy savings - some experiences from two schools in Italy and Greece. *Journal of Ambient Intelligence and Humanized Computing*. <https://doi.org/10.1007/s12652-020-02838-7>
- Najjar, E., & Salhab, R. (2022). Gamification in the Learning Process. *International Journal of Online and Biomedical Engineering*. <https://doi.org/10.3991/ijoe.v18i01.26609>
- Ouariachi, T., Li, C. Y., & Elving, W. J. L. (2020). Gamification approaches for education and engagement on pro-environmental behaviors: Searching for best practices. *Sustainability (Switzerland)*. <https://doi.org/10.3390/su12114565>

Published proceedings:

- Rodrigues, P., Souza, M., & Figueiredo, E. (2019). Games and gamification in software engineering education: A survey with educators. *Proceedings - Frontiers in Education Conference, FIE*. <https://doi.org/10.1109/FIE.2018.8658524>

ACKNOWLEDGMENTS

This research is supported by grants from the Sultan Ahmad Shah Islamic University College (KUIPSAS) (Project No. RUG-KUIPSAS-2021-02).

Domestic Travelers' Preferences in Selecting Transportation Mode in the Post-COVID-19 Pandemic

Afifah Hanim Md Pazil

*Faculty of Entrepreneurship and Business, Universiti Malaysia Kelantan,
16100, Kota Bharu, Kelantan, Malaysia*
hanim.mp@umk.edu.my

Yuhanis Mohamed Noor

*Faculty of Entrepreneurship and Business, Universiti Malaysia Kelantan,
16100, Kota Bharu, Kelantan, Malaysia*
yuhanis.mn@umk.edu.my

ABSTRACT

Selecting the right mode of transport during traveling is an imperative decision-making process to ensure it could meet the needs and satisfaction of the travelers. This study aims to determine the decision factors of the transportation mode of domestic travelers, specifically in the post-coronavirus disease (COVID-19) outbreak. The study adopted a survey through a quantitative approach by distributing questionnaires among domestic travelers in Malaysia. Descriptive analysis, reliability analysis, correlation analysis, and multiple linear regression analysis were applied to achieve the objectives of the study. Three factors were examined: value for money, safety and transit time. The results discovered a significant relationship between value for money and safety towards transportation mode. The findings of this study may assist relevant authorities and travel agencies to enhance and improve the quality of their services to cater different travelers' preferences.

Keywords: *value for money; safety; transit time; transportation mode; domestic traveler.*

INTRODUCTION

Coronavirus disease 2019 (COVID-19) is an infectious disease that has spread worldwide since the first case appeared in December 2019 in Wuhan, China. Many people thought it would be like the SARS family virus and predicted that COVID-19 might not be dangerous. However, this virus is more contagious and can be fatal for people with underlying medical conditions (Siswantoro, 2022). On March 18, 2020, the government of Malaysia enforced the Movement Control Order (MCO) to curb the spread of COVID-19. Subsequent to the enforcement of MCO and interstate border restrictions in Malaysia, domestic tourism in Malaysia continued to drop in the number of visitor arrivals and tourism expenditure. A total of 66.0 million visitors were recorded in 2021, with a negative growth of 49.9 percent compared to the previous year (Department of Statistics Malaysia, 2022a). Hence, many companies running their business, especially in tourism industry had to suspend their operation due to the pandemic. The announcement of the lockdown significantly impacted travel agencies around the country. Therefore, travel agency operators have tried to understand how to prevent business losses. Understanding travelers' preferences can be a crucial factor in the planning of tourism authorities and travel agencies, especially in determining marketing strategies (Afifah Hanim et al., 2020).

According to the Department of Statistics Malaysia (2022a), transportation is one of the components of the expenditure of domestic travelers. It shows the importance of transportation in the tourism industry. Travelers need to use transportation to commute from one destination to another selected destination of travel. Does the tourism industry know the

importance of transportation? Does the transportation provider satisfy the travelers' needs? Do tourism and transportation agencies know the factors influencing domestic travelers' decision-making towards choosing the mode of transport? Thus, this study investigated the decision factors of domestic travelers towards selecting the transportation mode, specifically in the post-COVID-19 pandemic in Malaysia. In addition, this study also examined the influence of value for money, safety and transit time on the selection of transportation mode in the post-COVID-19 pandemic in Malaysia.

LITERATURE REVIEW

Mode of Transportation

The synonyms of mode of transportation are means of transportation, transportation modality and form of transportation. Topolšek et al. (2018) defined transportation as a movement of passengers to create or increase customer satisfaction, whereby moving from one point of origin to another point within a certain period. Bowersox et al. (2020) defined mode of transportation as a solution that makes use of a particular type of vehicle, operation and infrastructure. There several types of transportation modes which are air, water, road and rail. A traveler's transportation may involve one or several modes, with the latter being called intermodal or multimodal transportation. Each mode has its advantages and disadvantages. It will be chosen by a traveler based on the price value, safety and transit time.

Value for Money

In this study, value for money can be described as travel cost or price value using transportation. In general, as travel costs increased, the utilization of any mode of transportation decreased (Gudzinas, 2012). A study by Nguyen-Phuoc et al. (2018) revealed that travel price is related to an individual's choice in choosing mode of transportation. Can (2013) stated that transportation costs are closely associated with travel distance. He also mentioned that the income of a traveler had an impact on choosing their transportation mode. Therefore, the travel costs are represented as a fraction of the income budget. According to Mohammad Nizamuddin et al. (2021), each travel modes have specific characteristics, such as travel cost that influence travelers' selection of transportation mode. Hosseini et al. (2020) research shows that consumers will be attracted to any deal offering a better price value during sales or promotion. Thus they will spend their money on that promotion. Thus, the first hypothesis is stated as below:

H1: Value for money has an influence on the selection of transportation mode in the post-COVID-19 pandemic.

Safety

The Coronavirus has reorganized and developed new behavior during lockdown and quarantine. During the outbreak, travelers were not encouraged to travel, and there is enforcement of interstate border restrictions in Malaysia. This is due to the impact of an invisible COVID-19 virus, which forces travelers to remain at home since their safety would be compromised. Mohammad Nizamuddin et al. (2021) defined safety as freedom from danger, risk, or threat of harm, injury, or loss to personnel and/or property, whether caused deliberately or accident. Their study also shows there is a significant relationship between safety and travelers' preferences. Enhancing safety can positively impacts for travelers to travel either on

short-distance or long-distance journeys. In addition, a survey by Ingvardson and Nielsen (2021) reported that 77% of travelers agreed with the safety issues that affect them choosing a mode of transportation. Olsson (2003) said that when a passenger feels insecure, they might change to select another mode of transportation that may bring them to feel secure and safe. Hence, the second hypothesis formed as below:

H2: Safety has an influence on the selection of transportation mode in the post-COVID-19 pandemic.

Transit Time

Time can be defined as the length of time taken to complete an activity. Thus in this study, waiting time and travel time can also be described as transit time. In the e-commerce philosophy, timing is critical in delighting and retaining consumers (Zulkarnain et al., 2015). Mohammad Nizamuddin et al. (2021) mentioned that each travel modes have specific characteristics, such as waiting time that influences travelers' preference of transportation mode. Gudzinis (2012) stated that as travel time decreased, the utilization of any modes of transportation increased. According to Racca and Ratledge (2003), the choice of transportation mode would be somewhat dependent on the relative time between transit and personal vehicle trip time. Based on the discussion, the third hypothesis is proposed as below:

H3: Transit time has an influence on the selection of transportation mode in the post-COVID-19 pandemic.

Conceptual Framework

The conceptual framework for the domestic travelers' preferences in selecting transportation mode in the post-COVID-19 pandemic is presented in Figure 1 below:

Figure 1. Conceptual Framework

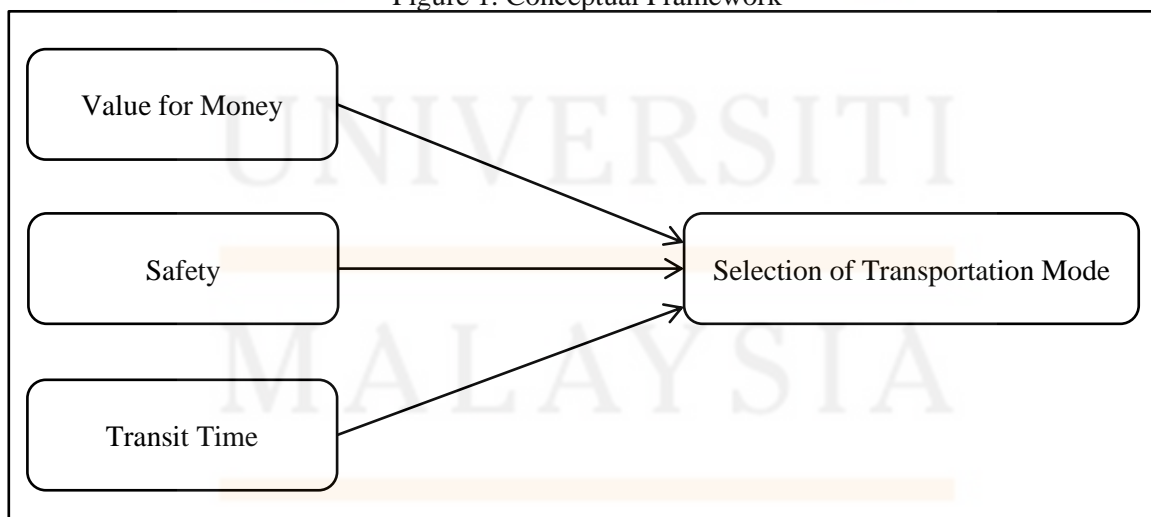

METHODOLOGY

Questionnaire was the primary source of collecting data for this study. It was divided into three sections. The first section, Section A, contains five questions about the respondents' demographic profiles. Next, Section B has questions related to the independent variables: value

for money, safety and transit time. Finally, Section C was associated with the selection of transportation mode among domestic travelers, which was the dependent variable in this research. The entire set of questions in both Sections B and C was measured using a 5-point Likert Scale, ranging from strongly disagree (1) to strongly agree (5).

The target population in this study was the domestic travelers who traveled during the post-coronavirus disease (COVID-19) outbreak. According to the Department of Statistics Malaysia (2022b), a domestic traveler is defined as a resident or those living in Malaysia for at least a year, including expatriates and non-citizens who take a trip to main destinations outside his/her usual environment. The journey should take less than a year for business, leisure or personal goals other than to be employed by a resident entity in the place visited. To the authors' knowledge, there is no reported list of domestic travelers who traveled during the post-coronavirus disease (COVID-19) outbreak. Thus, non-probability convenience sampling was used in this research. According to Hair et al. (1998), the standard sample size rule for the unknown population is at least five times more than the items to be analyzed. Thus, this study requires at least 60 respondents (5 x 12 items). Nevertheless, 95 questionnaires were distributed instead of 60 questionnaires.

The IBM SPSS Statistics version 26 was used to analyze the data that was obtained from the questionnaire. Descriptive analysis, reliability analysis, correlation analysis and multiple linear regression analysis were applied to achieve the study's objectives. Descriptive analysis was used to examine the demographic profile of the respondents. In measuring the reliability analysis, Cronbach's Alpha Coefficient value was used to know the dependability, which then described the internal consistency or average correlation of items. Next, the correlation analysis was an analysis that functioned to identify whether there was any relationship between the independent variables and the dependent variable (Hair et al., 2019). To generate valuable data for this study, Multiple Linear Regression Analysis was utilized to predict the value of a variable based on the values of two or more variables. For this study, the Multiple Linear Regression equation model was as follows:

$$\begin{aligned} & \textit{Selection of Transportation Mode in the post - COVID - 19 Pandemic} \\ & = \hat{\beta}_0 + \hat{\beta}_1 \textit{ValueForMoney} + \hat{\beta}_2 \textit{Safety} + \hat{\beta}_3 \textit{TransitTime} \end{aligned}$$

FINDINGS AND DISCUSSIONS

Demographic Profile of Respondents

Table 1 shows the detailed demographic profile of the respondents. Among the 95 respondents, 37.9% were male and 62.1% were female. Additionally, more than half of the respondents were 18 to 30 years old (69.5%), followed by 31 to 40 years old (17.9%) and 41 years old and above (12.6%). Furthermore, most of the respondents were government employee (64.2%), while private sector employee 24.2%, self-employed 8.4% and retired 3.2%. Finally, the highest reason for the respondents to travel in post-COVID-19 pandemic was because of personal reason (42.1%). It was followed by both personal reason and business or working purpose (40.0%). The least common reason was because business or working purpose (17.9%).

Table 1. Demographic Profile

Demographic Profile	Categories	Frequency	Percentage %
Gender	Male	36	37.9
	Female	59	62.1

Age	18 to 30 years old	66	69.5
	31 to 40 years old	17	17.9
	41 years old and above	12	12.6
Occupation	Government Employee	61	64.2
	Private Sector Employee	23	24.2
	Self-Employed	8	8.4
	Retired	3	3.2
Purpose of travelling in post-COVID-19 pandemic	Unofficial travel/ Personal reason	40	42.1
	Official travel/ Business/ Working Purpose	17	17.9
	Both	38	40.0
	Long haul (International)	26	27.4

Reliability Analysis

Table 2 below presents Cronbach's Alpha Coefficient values. Those values indicate the reliability of the questionnaire. Based on the table below, Cronbach's Alpha Coefficient values for all variables were above 0.7, representing good value.

Table 2. Reliability Analysis

Variable	Number of items	Cronbach's Alpha
Transportation Mode Selection	3	0.809
Value for Money	4	0.782
Safety	4	0.732
Transit Time	4	0.763

Correlation Analysis

Pearson's Correlation Analysis is presented in Table 3 below. The p-value of 0.000 for value for money, safety and transit time is lower than the significant level of 0.01. This value indicates that there are significant relationships between independent variables and dependent variable. Meanwhile, Pearson's Correlation value between value for money and selection of transportation mode was 0.639. Thus, there is a moderate relationship between value for money and selection of transportation mode. Next, Pearson's Correlation value between safety and selection of transportation mode was 0.597. Hence, there is a moderate relationship between safety and selection of transportation mode. Finally, Pearson's Correlation value between transit time and selection of transportation mode was 0.382. Therefore, there is a small but definite relationship between transit time and selection of transportation mode.

Table 3. Pearson's Correlation Analysis

		Transportation Mode Selection
Value for Money	Pearson Correlation	0.639**
	Sig. (2-tailed)	0.000
	N	95
Safety	Pearson Correlation	0.597**
	Sig. (2-tailed)	0.000
	N	95
Transit Time	Pearson Correlation	0.382**
	Sig. (2-tailed)	0.000
	N	95

** . Correlation is significant at the 0.01 level (2-tailed).

Multiple Linear Regression Analysis

In the following analysis stage, multiple linear regression analysis was used to test the hypotheses. The multiple linear regression results are presented in Table 4 and 5.

Table 4. Multiple Linear Regression Summary

R	R Square	Adjusted R Square	Std. error of the estimate	F	Sig.
0.720 ^a	0.519	0.503	0.44233	32.732	0.000 ^b

a. Predictors: (Constant), Value for Money, Safety and Transit Time

b. Dependent Variable: Selection of Transportation Mode

The results from Table 4 shows that multiple regression coefficients (R) was 0.720, indicating value for money, safety and transit time have a strong positive relationship with the selection of transportation mode. The value of the coefficient of determination (R Square) is 0.519. This means that 51.9% of the total variance in the selection of transportation mode can be explained by value for money, safety and transit time. Other factors explained the remaining 48.1%. The p-value from Table 4 is 0.000, which is less than the significant level of 0.05. It means that one of the independent variables (value for money, safety and transit time) can be used to model the selection of transportation mode.

Table 5. Coefficients^a Summary

Model	Unstandardized Coefficients		Standardized Coefficients	t	Sig.
	B	Std. Error	Beta		
(Constant)	0.190	0.446		0.427	0.006
Value for Money	0.382	0.089	0.391	4.294	0.000
Safety	0.414	0.100	0.356	4.152	0.000
Transit Time	0.161	0.087	0.147	1.862	0.066

a. Dependent Variable: Selection of Transportation Mode

Table 5 above shows the coefficients summary of the study. Only the variables with a p-value of less than 0.05 were maintained in the model. Hence, values for money and safety have a significant influence on the selection of transportation mode. However, transit time significantly did not have an influence on selection of transportation mode. According to the absolute value of the standardized beta coefficients, value for money appeared to be the strongest explanatory variable to predict the selection of transportation mode, followed by safety. The equation model for this study was as follows:

$$\text{Selection of Transportation Mode in the post - COVID - 19 Pandemic} \\ = 0.190 + 0.382\text{ValueForMoney} + 0.414\text{Safety}$$

The summary of the results of the hypotheses examined in this study is presented in Table 6 below.

Table 6. Summary of hypotheses testing results

	Hypothesis	Result
H1	Value for money has an influence on the selection of transportation mode in the post-COVID-19 pandemic.	Accepted
H2	Safety has an influence on the selection of transportation mode in the post-COVID-19 pandemic.	Accepted

H3	Transit Time has an influence on the selection of transportation mode in the post-COVID-19 pandemic.	Rejected
----	------------------------------------------------------------------------------------------------------	----------

In this study, multiple analyses are done on different independent variables to check whether the results are aligned with the existing literature. The hypothesis that value for money has an influence on the selection of transportation mode supports the finding of Nguyen-Phuoc et al. (2018). Finally, the finding depicted that safety also has an influence on the selection of transportation mode, aligned with the previous study of Mohammad Nizamuddin et al. (2021).

CONCLUSIONS

There is no secret that the tourism industry has been affected badly by the COVID-19 pandemic. Subsequent to the enforcement of MCO in Malaysia, many companies that were running their business in the tourism industry had to suspend their operation due to the pandemic. Hence, this study aims to investigate the decision factors of domestic travelers towards choosing the transportation mode, specifically in the post-COVID-19 pandemic. The variables to be considered were value for money, safety and transit time. This study revealed that value for money and safety significantly influence the selection of transportation mode among domestic travelers in the post-COVID-19 pandemic in Malaysia. The findings of this study may assist travel agencies, Land Public Transport Commission (SPAD), transport agencies, and public transportation providers to enhance and improve the quality of their services to cater different travelers' preferences. On the other hand, this study will help other researchers who would like to study this topic further.

LIMITATIONS AND SUGGESTIONS FOR FUTURE RESEARCH

The number of respondents for this study is 95 respondents. The number should be increased for future studies to enhance the quality of the data collection. Moreover, this study only focused on three factors in the selection of transportation mode. Hence, future studies should be conducted considering other factors. Finally, further study may be carried out on the same issues in other industries.

REFERENCES

- Afifah Hanim Md Pazil, Marlisa Abdul Rahim, & Azlinda Shazneem Md Shuaib. (2020). The Application of Analytical Hierarchy Process (AHP) for Students' Preferences in Tourism Destination Selection. *Paideuma Journal*, 13(5), 103-108.
- Bowersox, D. J., Closs, D. J., Cooper, M. B., & Bowersox, J. C. (2020). *Supply Chain Logistics Management*. United State: McGraw-Hill.
- Can, V. V. (2013). *Modelling tourism demand, travel mode choice and destination loyalty*. (Unpublished doctoral dissertation). University of Tromso.
- Department of Statistics Malaysia. (2022a). *Performance of Domestic Tourism Survey 2021*. Domestic Tourism Survey, Department of Statistics Malaysia.
- Department of Statistics Malaysia. (2022b). *Sampling Design for Domestic Tourism Survey Malaysia*. Domestic Tourism Survey, Department of Statistics Malaysia.
- Gudzinis, B. (2012). Development of Long-Distance Multimodal Passenger Travel Modal Choice Model. *Journal of Transport Geography*, 1, 1-84.
- Hair, J. F. Jr., Anderson, R. E., Tatham, R.L., & Black, W.C. (1998). *Multivariate Data Analysis (5th Edition)*. Upper Saddle River, NJ: Prentice Hall.

- Hair, J. F., Page, M., & Brunsveld, N. (2019). *Essentials of business research methods*. Routledge.
- Hosseini, S. H., Zadeh, F. H., Shafiee, M. M., & Hajipour, E. (2020). The effect of price promotions on impulse buying: the mediating role of service innovation in fast moving consumer goods. *International Journal of Business Information Systems*, 33(3), 320-336.
- Ingvardson, J. B., & Nielsen, O. A. (2021). The influence of vicinity to stations, station characteristics and perceived safety on public transport mode choice: a case study from Copenhagen. *Public Transport*. <https://doi.org/10.1007/s12469-021-00285-x>
- Mohammad Nizamuddin Abdul Rahim, Zuraimi Abdul Aziz, Abdul Aziz Mat Hassan, Mohd Fathi Abu Yazid, Muhammad Ashlyzan Razik, Zamri Miskam, & Nora'ani Mustapha. (2021). Factors Influencing Passengers' Preference towards Public Bus Transportation from Kelantan to Northern Region. *Turkish Journal of Computer and Mathematics Education*, 12(3), 2572-2583.
- Nguyen-Phuoc, D. Q., Amoh-Gyimah, R., Tran, A. T. P., & Phan, C. T. (2018). Mode choice among university students to school in Danang, Vietnam. *Travel Behaviour and Society*, 13, 1-10. <https://doi.org/10.1016/j.tbs.2018.05.003>
- Olsson, A.-L. L. (2003). Factors that influence choice of travel mode in major urban areas. *Division of transportation and logistic*, 64.
- Racca, D. P., & Ratledge, E. (2003). *Factors That Affect and/or Can Alter Mode Choice*. Newark, Delaware: University of Delaware.
- Siswantoro, D. (2022). Combating COVID-19 in Indonesia: Local Government Use of Smart City System Support. In: Alareeni, B., Hamdan, A. (Eds.) *Financial Technology (FinTech), Entrepreneurship, and Business Development. ICBT 2021. Lecture Notes in Networks and Systems*, vol 486. (pp. 205-217). Springer, Cham. https://doi.org/10.1007/978-3-031-08087-6_15
- Topolšek, D., Čižiūnienė, K., & Ojsteršek, T. C. (2018). Defining Transport Logistics: A Literature Review and Practitioner Opinion Based Approach. *Transport*, 33(5), 1196-1203. <https://doi.org/10.3846/transport.2018.6965>
- Zulkarnain, K., Ahasanul, H., & Selim, A. (2015). Key success factors of online food ordering services: An empirical study. *Malaysian Institute of Management*, 50(2), 19-36.

English at Workplace: A Quantitative Report on Communication Apprehension among Malaysian Employees

Mohd Zulfadli Mat Husin
Universiti Malaysia Kelantan
zulfadli.mh@umk.edu.my

ABSTRACT

Oral communication had been regarded as one of the important element especially in Malaysian workplace context and the use of English language had been deemed to be the necessary requirement for employees. Based on series of literature review, only a few studies had been done toward examining communication apprehension issue using English within Malaysian workplace context. With the aim of investigating English oral communication apprehension among Malaysian employees, the study adopted quantitative approach and use PRCA-24 as the main instruments to 352 respondents. From PRCA-24, four communicative events were measured which group discussion, meeting, conversation and public were speaking. Overall, Malaysian employees recorded a moderate level of CA using English at workplace. In addition, government employees are more apprehensive compare to their counterpart. Both private and government employees recorded higher level of CA during public speaking and meeting. In relation to demographic variables, gender, job sector and highest education levels were found to be significant in influencing level of CA among Malaysian employees whilst both age and years of service were not. The study inferred some important findings that could help in understanding English communication apprehension at workplace and Malaysian employers (private and government) need to consider continuous professional development to further enhancement English communication competency of their employees resulting in lowering CA level.

Keywords: *Communication Apprehension; Malaysian employees; English for Specific Purpose; English competency; PRCA-24*

INTRODUCTION

In a simplified way, oral communication can be defined as an activity that involve using oral speech to communicate to the other persons. Within the context of English as second language here in Malaysia, the ability to use English language in oral communication have always been deemed to be very significant. Much attention has been put toward the importance of mastering English oral communication ability for Malaysian undergraduate before they enter workplace sector. Despite its ever-increasing significance in workplace and academic setting, most second language learners still consider speaking using English language as the most daunting skill to master.

Taking into the perspective of workplace communication, having good oral communication skills using English language is one the ways to become a successful employee. Indeed, the skill is regarded to be an additional advantage for employees (Moslehifar & Ibrahim, 2012). In addition, speaking or oral communication skills need to be highlighted as the most important skills compared to other language skills as this skills is the most focused upon by employer (Kassim & Ali, 2010). Hence, is pertinent for employees to master oral communication or speaking skills in English whether it is for ESL or EFL contexts. However, Jusoh et al.(2018) mentioned that for many English learners, speaking skill is the most daunting skill to be developed and mastered. One possible reason behind this is due to lack of proficiency in speaking skills wherein speakers concern their image might be tarnished in front of other

individual consequently their language self-worth (Brown, 2001). The feeling of anxiety in communication can be described as communication apprehension. Communication apprehension (CA) is a term related to “individuals fear or anxiety that are linked with actual or anticipated communication with another person’s” (McCroskey & McCroskey, 1988, p.40).

In this era of globalization where most Malaysian organization either private or government sector embrace, the need for English language is increasingly higher than before. Mastery of English language communication in the workplace context help toward employee to optimize the use of latest technology in which most of today’s advance technology uses English language as an operating medium language. In addition to that, having good command of English communication skill enable employees as well as employer to have a good interpersonal relationship based on the effective communication skill. Thus, employers and employees need to have good ability to communicate in English (Putra et al., 2022). By experiencing apprehensive in using English language at workplace, individuals might encounter problem to communicate effectively affecting the organisation overall productivity.

Prior researches delves into individuals’ apprehension or anxiety especially in the context of second language acquisition among secondary students (Bastida Jr. & Yapo, 2019; Jones & Procopio, 2017) and tertiary students (Kimberley et al., 2020; Razawi et al., 2015; Zulkifli, 2007). On the contrary, only a few scholars probed CA among professionals within workplace context especially in Malaysia (Abdullah, 2014; Jassim, 2020; Jusoh et al., 2018; Mat Husin & Khamis, 2021). To that end, this paper explores communication apprehension on English language usage at workplace among Malaysian employees. Based on that objective, the following research questions were formulated:

1. What are the CA levels among Malaysian employees?
2. Do Malaysian private and government employees differ in term of CA level?
3. What effect do demographic variables such as gender, age, years of service, and education level have on the level of CA among Malaysian employees?

LITERATURE REVIEW

Oral Communication Apprehension

James C. McCroskey (1997) had introduced the CA concept in which sources of CA are on a scale consisting four kind of CA which are ‘Trait-like CA, Context-Based CA, Audience-Based CA and Situational CA’. Trait-like CA is being defined by McCroskey (1997) as a type of CA that “is relatively enduring, personality-type orientation toward a given mode of communication across a wide variety of context”. In other word, Trait-like CA is associated with the ‘personality of an individual and is variables hardly change over time’ (Rasakumaran & Indra Devi, 2017). A personality of an individual seldom change over the period of time if they did not receive any treatment or intervention thus their level of CA will stay the same. The different measurement tools which examine the level of anxiety based on the type of CA produced similar scores without any treatment given (McCroskey, 1997).

Over the years, out of the four types of CA, Trait-like CA had been studied the most (Rimkeeratikul, 2018). Following that course, the current study also concentrates toward examining Trait-like based CA in which the scores of staff toward different communicative events in workplace which are group discussion, interpersonal conversation, meetings and public speaking.

Related Studies on Communication Apprehension

Following a series of studies carried out dissecting CA in a workplace setting, experts found interesting relationship between CA level of individuals and variables in workplace context. Winiecki & Ayres (1999) revealed that individuals with high level of CA did not score well in the job interview and this suggested that those with high level of CA had fewer chances in promotion compared to those with lower CA level. Moreover, individuals with high CA were perceived to be less productive compared to others, less likely to hold higher position, scored low level in job satisfaction and their superior or supervisor tend to have lower expectation (Winiecki & Ayres, 1999). Based on this, it is very significant to explore whether people that are apprehensive to communicate with other people able to work longer in an organization or they had developed some coping strategies to adapt with certain situations.

Despite several reviews in the literature that examined CA level, only a few studies have discussed the CA issue within Malaysian context especially within workplace.

Focusing on the years of service variable with CA levels, Kakepoto et al. (2013) conducted a study to examine the CA among engineers in Pakistan who had minimum of five years working experience. The study which use observation as the main instruments, found out that CA levels greatly influence staff job performance as engineers with higher level of CA tend to have low level of confident, showed poor body language and exhibited anxiety in their oral presentation performance (Kakepoto et al., 2013).

Using 268 pharmacy undergraduate students as respondents, a study by Khan et al. (2009) revealed that female produced higher level of CA compared to male. Beside gender, the study proved that race, age and year of study were significant factors that can linked with CA (Khan et al., 2009).

Another study carried out by Loureiro et al. (2020) found out that female respondents from Portugal recorded high level of CA in all dimension of oral communication. This study used PRCA-24 for oral CA and Daly -Miller Writing Apprehension Test (DMWA) for written CA as it's' research instrument. Also, it was found out that female score the highest in the meeting dimension and lowest in group talking.

A study which used PRCA-24 was conducted by Jusoh et al. (2018) which aimed to examine the categories of oral communication apprehension among administrative officers and differences between level of CA with gender and length of service. The study aimed toward 150 officers from different department in a Malaysia public university. The findings was consistent with earlier study by Abdullah (2014) in which majority of non-academic or administrative staff recorded low level of CA when using English at their workplace. The study also found out that female showed higher apprehension score compared to male staffs and those staff who served in workplace less than 5 years recorded the lowest CA level compared to other staff.

As most researches done on CA being conducted in classroom contexts among secondary and tertiary students, there is scarcity of research in relation toward exploring CA in a government sector. Only a few studies (Abdullah, 2014; Jusoh et al., 2018; Mat Husin & Khamis, 2021) had been conducted out focusing on CA among Malaysian employees thus this study hopes to fill gaps in the research.

METHODOLOGY

The purpose of this study is to investigate Malaysian employee's communication apprehension using English language at workplace. The study use quantitative method in providing answers to the research questions because this method can yield results that can be replicate and generalize to the whole sets of population (Daniel, 2016). Based on the sampling, research

objectives and data gathered from this study, the results can reflect toward wider population of employees. Also, due to the flexibility of using quantitative approach, future research can replicate the instrument, procedures or data analysis procedure from this study using different population or scope yet still produce the same results or data interpretation.

This study adopted convenience sampling in which a total of 353 respondent took part in the survey. The reason behind selecting convenience sampling is that, this type of sampling is easy to use and required less cost to collect data from respondents. In addition to that, the scope of the study is Malaysian employees in which the total number of populations would be enormous thus it would be problematic to collect the right number of respondents according to the other sampling technique. The selection of convenience sampling in this study was based on the availability of Malaysian employees to take part as respondents. 353 respondents voluntarily agreed to take part in this study.

Survey questionnaire was used as the main instrument in this study. The survey adapted the PRCA-24 (Jusoh et al., 2018; McCroskey, 1984) with additional items added to provide answer to the research questions. The survey had 29 items divided into 2 section: section A was on respondents' demographic information, section B was on respondents' feeling toward English communication at workplace also known as PRCA-24. The survey employed a 5-point Likert scale ranging from Strongly Agree to Strongly Disagree.

The item in the survey achieved the alpha value of 0.973 for all the 24 items which is considered to be high level in term of internal consistency (George & Mallery, 2003). The survey questionnaire was adapted from Jusoh et al. (2018)'s study in which their study's share similar objective of exploring English communication apprehension in workplace setting. However, the current study expanded the scope toward larger sampling and broader context in which the earlier study only focusing toward public university administrative staff.

To collect data from respondents, the survey was circulated via Google email and WhatsApp platform using Google Form. The study employed convenience sampling in which the researcher circulated as much as possible survey to Malaysian private and government employees. After three week, 353 respondents completed the survey and all the answered were stored in Google Drive platform. The data were then analysed and presented in term of their frequency and percentage. Due to some uneven distribution in 'Highest education background' categories in which initially there were six categories but then were combined into four categories. Due to similar uneven distribution of respondents, 'Years of Service' categories were combined into four from five.

Descriptive and inferential statistics in the form of comparing frequency, mean scores, standard deviation, t-tests and one-way ANOVA as well as multiple linear were employed to examine the current study population concerning gender, level of education, year of service, job sectors and age. Furthermore, the CA level scores calculations were based on the guidelines by McCroskey & McCroskey (1988). PRCA sub-score calculation for each communicative event is detailed in the following table. The overall CA score is a sum of all the communicative event scores.

Table 3. Calculation of PRCA Sub Scores for the Four Workplace Communicative Events

Communicative Events	PRCA Sub Scores Calculations
Group Discussion	$18 - [\sum \text{scores (item 2 + 4 + 6) + (item 1 + 3 + 5)}]$

Meetings	18 – [Σ scores (item 8 + 9 + 12) + (item 7 + 10 + 11)]
Daily Conversation	18 – [Σ scores (item 14 +16 +17) + (item 13 + 15 + 18)]
Public Speaking	18 – [Σ scores (item 19 + 21 + 23) + (item 20 + 22 + 24)]
Overall CA level	Group Discussion + Meetings + Conversation + Public Speaking

As depicted in Table 1, the PRCA score for each of the four communicative events (i.e., group discussion, meetings, conversation, and public speaking) can range from a minimum of six to the highest of 30. If a score for an event is above 18, it indicates some degree of CA. For the overall CA score, the range is between 24 to 120. If the score is above 80, the individual has a high level of CA.

Table 4. Level of CA Categories based on PRCA Scores

Communicative Events	CA Levels		
	Low	Moderate	High
Group Discussion	1 – 11	12 - 19	20 and above
Meetings	1 – 13	14 - 19	20 and above
Daily Conversation	1 – 11	12 - 17	18 and above
Public Speaking	1 – 14	15 - 23	24 and above
Overall CA	1 – 50	51 - 80	81 and above

In table 1, most of respondents are female employees ($n = 198$) whilst male respondents are 155. In term of age of respondents, most respondents are in the group of 30 until 39 years old ($n = 245$) followed by 40 until 49 years old ($n = 48$), 21 until 29 ($n = 34$) and lastly 50 years old and above only 26 (7.4 percent). 145 respondents are in the group of 11 to 15 years of service, followed by 6 to 10 years ($n = 134$), 0 to 5 years ($n = 52$) and only 22 respondents have 16 years and above in relations toward years of service. With reference to respondents highest education background, most respondents hold Bachelor degree ($n = 181$), followed by STAM/STPM/Diploma ($n = 76$), PMR / SPM ($n = 54$) and only 42 of them hold Master or PhD degree. Concerning job sectors, most respondents are in government sectors ($n = 305$) whilst only 48 of respondents worked in private sectors.

Table 5. Respondents' Demographic Information

Profile	Category	Frequency	Percentage
Gender	Male	155	44
	Female	198	56
Age	21 until 29	34	9.6
	30 until 39	245	69.4
	40 until 49	48	13.6
	50 and above	26	7.4
Years of Service	0 to 5	52	14.7
	6 to 10	134	38
	11 to 15	145	41.1
	16 and above	22	6.2
Highest Education Background	PMR /SPM	54	15.3
	STAM/STPM/Diploma	76	21.5
	Bachelor	181	51.3
	Master / PhD	42	11.9
Job Sector	Private	48	13.6
	Government	305	86.4

RESULTS

Malaysian Employees CA Levels

Table 4 showed the overall CA scores of respondents along with the CA scores according to each communicative setting. Result showed that Malaysian employees ($n = 353$) experienced a moderate level of CA with mean score of 65.58. In relation to communicative events, Malaysian employees showed some degree of apprehension for public speaking context with mean score of 18.41, the highest among the four events. They also indicate they felt apprehensive in using English to communicate during meeting ($M = 18.28$) followed by conversation events ($M = 17.41$). The lowest score was recorded in group discussion ($M = 11.48$).

Table 6. Respondents' CA scores

Category	Mean	SD
Overall CA Score	65.58	18.51
Group Discussion Sub Score	11.48	3.70
Meeting Sub Score	18.28	5.42
Conversation Sub Score	17.41	5.41
Public Speaking Sub Score	18.41	5.29

From the finding, respondents experienced a moderate level of CA. The finding is in line with study carried out by Jusoh et al. (2018) who found out that most university administrative staff experience moderate level of apprehension. Similarly, Mat Husin & Khamis (2022) revealed that majority of Malaysian university administrative support staff did not felt apprehensive to communicate using English language at the workplace. Possible explanation that can be derived from this finding is that, most Malaysian employees are equip with the necessary English language communication skill. Hence, they are not afraid or felt anxious in using English at the workplace. Most Malaysian employers require their employees to have basic up until intermediate level in term of English competency before entering the workforce.

Comparing Malaysian Private and Government Employees CA Levels

An independent sample t-test was performed to compare overall CA score between private and government employees in using English language at workplace. The result showed that there is statistical differences in CA scores between private ($M = 55.96$) and government ($M = 67.10$), $t(55.58) = -3.21$, $p = .002$.

Table 7. CA Mean Score based on Job sectors

Job Sector	Mean	SD
Private	55.96	23.06
Government	67.10	17.25

	F	Sig.	t	df	Sig. (2-tailed)
CA Score	13.56	.000	-3.96	351	.000
			-3.21	55.58	.002

Table 8. T-test results for CA score between Job Sectors

In term of four communicative setting (meeting, public speaking, conversation and group discussion), table below showed that private employees scored the highest mean in Public Speaking (M=16.5) whilst government employees scored the highest during Meeting (M = 18.72). Both private (M = 9.80) and government (M = 11.74) employees scored the lowest in Group Discussion.

Table 9. CA Means Score between Private and Government for Communicative events

Communicative Events	Private	Government
Group Discussion	9.80	11.74
Meeting	15.5	18.72
Conversation	14.17	17.92
Public Speaking	16.5	18.71

From the second research question, comparing Malaysian private and government employees in levels of CA, findings showed that government employees scored higher CA level which indicated they are more apprehensive in using English language at the workplace compared to private employees. One possible explanation that can be derived from this was that in the government sectors, the use of Malay language as the official and formal language is more extensive compared to the use of English language. In relation to the comparison between private and government Malaysian employees' level of CA within the four communicative setting (meeting, public speaking, conversation and group discussion), private employees indicated they felt more apprehensive in using English language in giving public speaking.

In contrast, government employees felt most apprehensive during meeting. Both private and government employees felt less apprehensive in using English language during group discussion. Jusoh et al. (2018) studies on CA level in a Malaysian public university produced similar results which stated that Malaysian public university administrative staff felt most apprehensive during meeting. Meeting in the context of Malaysian government workplace often involve small or large people with different job grades, gender and year of service. This context can be quite intimidating to them especially using English language to communicate as they experience fear of evaluation on how they pronounce and use English words or phrases.

Demographic Variables (Gender, Age, Years Of Service, Education Background And Job Sectors)

To approach whether gender, job sector, years of service, education background and age can affect the overall CA scores among Malaysian employees at workplace, a multiple linear regression analysis was conducted to evaluate the prediction of overall CA scores from gender, job sector, years of service, education background and age. A significant regression equation was found ($F(5,347) = 10.561, p < .000$), with an R^2 of .132. Respondents predicted overall CA scores is equal to $66.557 + 5.405 (\text{Gender}) + 8.155 (\text{Job Sector}) - 5.264 (\text{Highest Education Background}) - .729 (\text{Years of Service}) - 2.886 (\text{Age})$. Gender, job sector and highest education

background were significant predictors of respondent's overall CA score ($p < .005$) however, both age and years of service were not statistically significant toward predicting respondents' overall CA score.

Table 10. Effect of Demographic variables on Malaysian Employees CA levels

Independent Variables	Coefficient
Gender	5.41 (1.90)*
Age respondents	-2.89 (1.77)
Job Sectors	8.16 (2.82)*
Years of Service	-0.73 (1.49)
Highest Education level	-5.26 (1.11)*
Constant	66.56

R² = 0.13
F-ratio = 10.56
n = 352

* $p < 0.05$

Note: Coefficients are unstandardized beta with standard errors in parentheses

Gender

Table 9 showed that female Malaysian employees are more apprehensive ($M = 68.48$) compared to male ($M = 61.88$). Both gender recorded moderate level of CA. An independent samples t-test was conducted to compare the CA scores between male and female Malaysian employees. There was a significant difference in the scores for male and female, $t(351) = -3.371, p = 0.001$.

Table 11. CA mean score between genders

Gender	Mean	SD
Male	61.88	17.42
Female	68.48	18.86

Table 12. T-rest result for CA score between genders

		F	Sig.	t	df	Sig. (2-tailed)
CA Score	Equal variances assumed	1.208	.272	-3.371	351	.001
	Equal variances not assumed			-3.404	341.540	.001

Age

Table 11 showed that respondent in the age of 30 until 39 scored higher mean ($M = 66.78$) which suggested that they are more apprehensive compare to other groups. Respondents in the age of 50 and above score the lowest mean ($M=61.46$) followed by 40 until 49 ($M=62.52$) and those in the age of 21 until 29 score 64.44. A one-way ANOVA was performed to compare the effect of age towards overall CA scores of respondents (Table 12). The results revealed that there was not a statistically significant difference in overall CA score between at least two groups ($F(3,349) = 1.26, p = .290$).

Table 13. CA score based on age

Age (years)	Mean	SD
21 until 29	64.44	19.62
30 until 39	66.78	18.29
40 until 49	62.52	16.97
50 and above	61.46	21.39

Table 14. ANOVA results between respondents' age groups

	Sum of Squares	df	Mean Square	F	Sig.
Between Groups	1286.864	3	428.96	1.255	.290
Within Groups	119322.921	349	341.90		

Years of service

Table below showed that respondents who have work 6 to 10 years in service scored higher mean ($M = 66.75$) which suggested that they are more apprehensive compare to other groups. Those in the group of 11 to 15 years in service scored mean ($M=65.72$) followed by those who just have 5 years and below ($M=65.23$) and lastly, those who have 16 years and above experience scored the lowest mean ($M = 58.36$). A one-way ANOVA was performed to compare year of service effects towards overall CA scores of respondents. The results revealed that there was not a statistically significant difference in overall CA score between at least two groups ($F(3,349) = 1.31, p = .272$).

Table 15. CA mean score based on Years of service

Years of Service	Mean	SD
0 to 5	65.23	21.58
6 to 10	66.75	16.31
11 to 15	65.72	17.83
16 and above	58.36	26.17

Table 16. ANOVA results on Years of service groups

	Sum of Squares	df	Mean Square	F	Sig.
Between Groups	1339.624	3	446.541	1.307	.272
Within Groups	119270.160	349	341.748		

Highest Education levels

Table 15 showed that respondents who have PMR or SPM as their highest education level scored higher mean ($M = 72.00$) which suggested that they are more apprehensive compare to other groups. Followed by those who have STAM/STPM/Diploma ($M = 71.38$), those who have bachelor degree ($M = 63.29$) and lastly, those who have Master or PhD scored the lowest ($M = 56.71$). A one-way ANOVA was performed to compare highest education levels effects towards overall CA scores of respondents. The results revealed that there a statistically significant difference in overall CA score between at least two groups ($F(3,349) = 9.42, p < 0.01$).

Table 17. CA mean scores based on Highest Education levels

Highest Education level	Mean	SD
PMR / SPM	72.00	12.19
STAM / STPM / DIPLOMA	71.38	16.45
BACHELOR	63.29	18.027

MASTER / PHD	56.71	24.65
--------------	-------	-------

Table 18. ANOVA results between highest education levels groups

	Sum of Squares	df	Mean Square	F	Sig.
Between Groups	9031.798	3	3010.599	9.417	.000
Within Groups	111577.986	349	319.708		

Tukey's HSD Test for multiple comparisons found that mean of CA scores was not significantly different between respondents who have PMR/SPM and STAM/STPM/Diploma ($p = 0.997$, 95 % C.I = [- 7.60, 8.83]). There was statistically significant difference in mean of overall CA score between PMR/SPM and Bachelor holders ($p = 0.01$) or between PMR/SPM holders and Master/PhD holders ($p < 0.01$).

Table 19. Tukey HSD Test results for highest education level groups

(I) Highest Education Levels	(J) Highest Education Levels	Sig.	95% Confidence Interval	
			Lower Bound	Upper Bound
PMR / SPM	STAM / STPM / DIPLOMA	.997	-7.60	8.83
	BACHELOR	.010	1.55	15.86
	MASTER / PHD	.000	5.79	24.78
STAM / STPM / DIPLOMA	PMR / SPM	.997	-8.83	7.60
	BACHELOR	.006	1.78	14.40
	MASTER / PHD	.000	5.79	23.54
BACHELOR	PMR / SPM	.010	-15.86	-1.55
	STAM / STPM / DIPLOMA	.006	-14.40	-1.78
	MASTER / PHD	.140	-1.33	14.48
MASTER / PHD	PMR / SPM	.000	-24.78	-5.79
	STAM / STPM / DIPLOMA	.000	-23.54	-5.79
	BACHELOR	.140	-14.48	1.33

The last research question concerned on the effect of demographic variables such as gender, age, years of service, and education levels have on the CA level among Malaysian employees at the workplace. Results from the tests surmised that gender, job sector and highest education background can be use as significant predictors toward CA levels of Malaysian employees. However, both age and years of service could not be treated as significant predictors in employees CA levels.

In relation to that, finding suggested that female Malaysian employees experience higher level of apprehensive in using English compare to male. This is corroborate with findings from several studies (Batiha et al., 2016; Loureiro et al., 2020; Rafek et al., 2014; Zulkifli, 2007) had recorded that female are more apprehensive using English language in communication. One possible reason behind this would be that due to the local social norms of Malaysia especially Malay women who are shy and talk less in front of other people or with the opposite gender.

An interesting finding was found in which respondents in the age of 50 and above are the less apprehensive compare to other age groups. Additionally respondents who have work 16 years in service and above are the least apprehensive compare to other groups. This finding is similar with (Nantanawanich, 2017) who claimed that those employees with more than 15 years of working experience had lower CA level. Those who are older and have longer working experience are more confident to use English language in any sorts of communicative events

thus reflecting in the lower CA level compare to those who have less years of working and younger.

Based on the results, respondents who have PMR or SPM as their highest education levels are more apprehensive compare to other groups. This suggested that those employees who have tertiary education are more confident to use English and less apprehensive at workplace to communicate. In relation to that, (Molnar & Crnjak, 2019) concluded that respondents with higher education (undergraduates and post graduate) have no significant difference in speaking apprehension compare to those who did not have higher education qualifications. Higher education equip Malaysian individuals to have better communication skills especially in using English language within the workplace context. Those who did not have higher education background would felt inferior and this affecting their confidence to talk with others and resulting in higher level of apprehension.

CONCLUSION

A number of interesting findings can be inferred from this study. The results revealed that Malaysian employees experienced a moderate level of English oral communication apprehension. Thus, it is likely that Malaysian employees were not greatly affected by the feeling of fear or anxious in using English language at workplace setting. In addition to that, comparing private and government employees, private employees are less apprehensive and both group of employees indicated that they are more apprehensive within the public speaking and meeting communicative events. Findings also suggested that workplace variables such as gender, age, years of service and level of education produced mixed results. Female employees and those who only have secondary education background are more apprehensive. Also, individuals who is younger and have less years of service are more apprehensive compare to those who are older and have longer years of service.

Still, opportunities to use English language at the workplace must be made more common or reasonably compulsory for the Malaysian employees whether in private or government sectors with the aim of enabling them to be more proficient in the English communication skills. Both private and government organizations should offer reassuring setting and incentive in inspiring their employees to constantly boost their English communication skills that can resulting in lowering down the CA level. It is worth noting that without organized or strategic professional communication programme or training, this average CA level could decline, resulting in affecting the employee's personality, organizations' reputation and productivity in general.

The findings also highlighting the need for serious consideration from the top management in both private and government organization in encouraging and setting significances for good English communication skills for the employees. Mastering the English language by administrative staff would enhance their daily tasks. Employees require good English communication skills as they would be dealing with external stakeholders especially coming from outside of Malaysia. Within the context of workplace learning, situated learning can be applied to improve Malaysian employees' English communication skills as they can improve their perception on learning English in a typical, familiar environment at their workplace (Matyakhan & Sukavatee, 2021).

Lastly, this study further supported on the need for more researches on CA in organizational contexts being carried out with the aim to provide more insight into challenges experienced by workers in actual workplace settings (Burk, 2001; Jusoh et al., 2018; Russ,

2013). Future studies are recommended to be carried out with different approaches such as ethnographic or a clinical way of gathering data to understand better this subtle yet complicated language phenomenon, which will contribute significantly to organizations' community of practice.

REFERENCES

- Abdullah, A. T. H. (2014). Communication Apprehension in Using English Language Among Non-Academic Officers at a Public University in Malaysia. *International Journal of Education and Research*, 2(12), 361–370.
- Bastida Jr., E. I., & Yap, J. R. (2019). Factors Contributing to Oral Communication Apprehension among selected Senior High School Students in Santa Rosa City, Laguna, Philippines. *Asia Pacific Journal of Contemporary Education and Communication Technology*, 5(2). https://apiar.org.au/wp-content/uploads/2019/07/2_APJCECT_v5i2_2019_pp.-10-20.pdf
- Batiha, J. M., Noor, N. M., & Mustaffa, R. (2016). Speaking Anxiety among English as a Foreign Language Learner in Jordan: Quantitative Research. *International Journal of Education and Research*, 4(10), 63–82. www.ijern.com
- Brown, H. D. (2001). *Teaching by principles : an interactive approach to language pedagogy*. Longman.
- Daniel, E. (2016). The Usefulness of Qualitative and Quantitative Approaches and Methods in Researching Problem-Solving Ability in Science Education Curriculum. *Journal of Education and Practice*, 7(15), 91–100. <https://doi.org/2222-288X>
- George, D., & Mallery, P. (2003). *SPSS for Windows step by step : a simple guide and reference 11.0 update*. Allyn and Bacon.
- Jassim, L. L. (2020). Administrative staff's use and learning of English to communicate with international students. *Research Journal of English*, 5(4), 169–188.
- Jones, K. T., & Procopio, C. H. (2017). Mentoring at-risk middle school students to reduce communication apprehension. *Mentoring and Tutoring: Partnership in Learning*, 25(2), 185–201. <https://doi.org/10.1080/13611267.2017.1326692>
- Jusoh, Z., Engku Atek, E. S., Syed Omar, S. N. M., & Abdullah, A. T. . (2018). Investigation into Non-Academic Staff Communication Apprehension in Using English Language. *International Journal of Asian Social Science*, 8(9), 677–685. <https://doi.org/10.18488/journal.1.2018.89.677.685>
- Kakepoto, I., Said, H., Habil, H., Umrani, A. I., & Memon, I. A. (2013). Workplace Communication : Oral Communicative Competence of Engineers in Engineering Workplace of Pakistan. *Journal of Economics and Sustainable Development*, 3(2), 131–139.
- Kassim, H., & Ali, F. (2010). English communicative events and skills needed at the workplace: Feedback from the industry. *English for Specific Purposes*, 29(3), 168–182. <https://doi.org/10.1016/j.esp.2009.10.002>
- Khan, T. M., Ejaz, M. A., & Azmi, S. (2009). Evaluation of communication apprehension among first year and final year pharmacy undergraduates. *Journal of Clinical and Diagnostic Research*, 3(6), 1885–1890.
- Kimberley, L. Y. L., Yih, Y. J., & Sandra, S. P. L. (2020). Undergraduates' Speaking Anxiety in English as Second Language (ESL) Classrooms. *International Journal of Service Management and Sustainability*, 4(1), 25. <https://doi.org/10.24191/ijms.v4i1.8180>
- Loureiro, M., Loureiro, N., & Silva, R. (2020). Differences of gender in oral and written communication apprehension of university students. *Education Sciences*, 10(12), 1–20. <https://doi.org/10.3390/educsci10120379>

- Mat Husin, M. Z., & Khamis, N. Y. (2021). Preferences or Requirements : Investigating Administrative Staff English Usage at Public Tertiary Institutions. *AJELP : Asian Journal of English Language and Pedagogy*, 10(1), 1–13. <https://doi.org/10.37134/ajelp.vol10.1.1.2022>
- Mat Husin, M. Z., & Khamis, N. Y. (2022). Preferences or Requirements : Investigating Administrative Staff English Usage at Public Tertiary Institutions. *AJELP : Asian Journal of English Language and Pedagogy*, 10(1), 1–13. <https://doi.org/10.37134/ajelp.vol10.1.1.2022>
- McCroskey, J. C. (1984). Communication apprehension perspective. In *Avoiding Communication: Shyness, Reticence, and Communication Apprehension* (pp. 13–38). Sage. http://www.jamescmccroskey.com/publications/bookchapters/003_1984_C1.pdf
- McCroskey, J. C. (1997). Willingness to Communicate, Communication Apprehension, and Self-Perceived Communication Competence: Conceptualizations and Perspectives. In *Avoiding communication: Shyness, reticence, and communication apprehension* (pp. 75–108). Hampton Press. http://www.jamescmccroskey.com/publications/bookchapters/020_1997_C3.pdf
- McCroskey, J. C., & McCroskey, L. L. (1988). Self-report as an approach to measuring communication competence. *Communication Research Reports*, 5(2), 108–113. <https://doi.org/10.1080/08824098809359810>
- Molnar, D., & Crnjak, G. (2019). Exploring Foreign Language Communication Apprehension among the English Language University Students in the English Language Classroom Setting. *European Journal of Social Science Education and Research*, 5(2), 27–39. <https://doi.org/10.2478/ejser-2018-0031>
- Moslehifar, M. A., & Ibrahim, N. A. (2012). English Language Oral Communication Needs at the Workplace: Feedback from Human Resource Development (HRD) Trainees. *Procedia - Social and Behavioral Sciences*, 66, 529–536. <https://doi.org/10.1016/j.sbspro.2012.11.297>
- Nantanawanich, P. (2017). *Anxiety of EFL Employees when using English Oral Communication at workplaces in Hong Kong And in Bangkok, Thailand*. Thammasat University.
- Putra, T. M., Yulia, C., & Ana. (2022). Systematic Literature Review on the Use of English in Workplace. *Proceedings of the 4th International Conference on Innovation in Engineering and Vocational Education (ICIEVE 2021)*, 651(Icieve 2021), 109–111. <https://doi.org/10.2991/assehr.k.220305.023>
- Rafek, M. B., Ramli, N. H. L. B., Iksan, H. B., Harith, N. M., & Abas, A. I. B. C. (2014). Gender and Language: Communication Apprehension in Second Language Learning. *Procedia - Social and Behavioral Sciences*, 123, 90–96. <https://doi.org/10.1016/j.sbspro.2014.01.1401>
- Rasakumaran, A., & Indra Devi, S. (2017). Oral Communication Apprehension Among Freshmen: a Case in the Faculty of Medicine. *Journal of Human Capital Development (JHCD)*, 10(1), 19–32.
- Razawi, N. A., Zulkornain, L. H., & Razlan, R. M. (2015). Anxiety in oral presentations among ESL students. *Journal of Academia UiTM Negeri Sembilan*, 7(1), 31–36.
- Rimkeeratikul, S. (2018). Comparison of Communication Apprehension in L1 and Communication Apprehension in L2 among MA Students with Different Ages Majoring in English in an International Program in Bangkok. *Arab World English Journal*, 9(3), 33–44. <https://doi.org/10.24093/awej/vol9no3.3>
- Winiiecki, K. L., & Ayres, J. (1999). Communication apprehension and receiver apprehension in the workplace. *Communication Quarterly*, 47(4), 430–440. <https://doi.org/10.1080/01463379909385572>

Zulkifli, V. (2007). Language Classroom Anxiety: A Comparative Study of ESL Learners.
Asian Journal of University Education, 3(2), 75–99.



UNIVERSITI

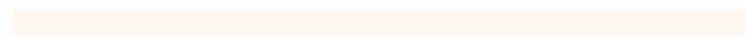

MALAYSIA

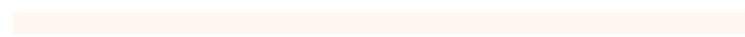

KELANTAN

Orientation Program of the Nutrition and Health Intervention Components to Stimulate Health Promoting School in Kediri District, East Java, Indonesia

Pratiwi Hariyani Putri

*Department of Nutrition, Universitas Nahdlatul Ulama Surabaya,
East Java, Indonesia, 60237
pratiwi@unusa.ac.id*

Ary Andini

*Department Medical Laboratory Technologist, Universitas Nahdlatul Ulama Surabaya,
East Java, Indonesia, 60237
aryandini@unusa.ac.id*

Sa'bania Hari Raharjeng

*Department of Nutrition, Universitas Nahdlatul Ulama Surabaya,
East Java, Indonesia, 60237
sabaniahr@unusa.ac.id*

Paramitha Viantry

*Department of Nutrition, Universitas Nahdlatul Ulama Surabaya,
East Java, Indonesia, 60237
mitaviantry@unusa.ac.id*

Dini Setiarsih

*Department of Nutrition, Universitas Nahdlatul Ulama Surabaya,
East Java, Indonesia, 60237
dinisetiarsih@unusa.ac.id*

ABSTRACT

A Health Promoting School (HPS) is a basic program to achieve quality of education by implementing and combining nutrition and health interventions to create a dynamic educational environment. The aim of the program activity is to implement the youth nutrition program in Junior High School (JHS) or Madrasah Tsanawiyah (MTs), and promote the HPS facilitators in Kediri District, East Java, Indonesia. The program was conducted together through collaboration with the United Nations Children's Fund (UNICEF) and Nahdlatul Ulama University Surabaya (UNUSA) in providing health orientation programs that consist of blood booster tablets, nutrition education, and healthy environment development. The health orientation program was attended by representatives from Junior High Schools (SMP/MTsN), the Regional Development Agency of Kediri District, Education authorities of Kediri District, and Health Authorities of Kediri District. The results of the coaching program produced 15 facilitators who carried out the mandate in pioneering HPS in their respective agencies and the surrounding environment.

Keywords: *Health Promoting Schools, Nutrition, health education, UNICEF.*

INTRODUCTION

One of the issues of obesity and stunting in children and adolescents is an important trend not only in Indonesia but also internationally. In Indonesia, easier access and more affordable costs to unhealthy foods high in fat, sugar and salt are the main causes of malnutrition (UNICEF

Indonesia, 2022). Indonesian data showed 13.5% of adults aged 18 years and over are overweight, meanwhile 28.7% are obese (BMI ≥ 25) and based on the 2015-2019 Regional Medium Term Development Plan indicators as many as 15.4% are obese (BMI ≥ 27), while in children aged 5-12 years, 18.8% were overweight and 10.8% were obese (Ministry of Health of the Republic of Indonesia, nd). Based on this important issue, the Ministry of Health of the Republic of Indonesia is actively promoting health, especially in schools.

As a trusted partner to governments, civil society and the private sector, the United Nations Children's Fund (UNICEF) is committed to helping children survive, thrive, and fulfill their potential from the child's life cycle from pregnancy to adulthood. UNICEF's activities in Indonesia include research, policy and program advice and practical support for equitable planning, financing and delivery of essential services for Indonesia's 80 million children, with a focus on the most vulnerable (UNICEF Indonesia, nd). One of the efforts to improve the quality of life of Indonesian children is to approach the Health Promotion School (HPS) which was pioneered by WHO. The HPS framework recognizes the inherent interrelationships between health and education: healthy children achieve better educational outcomes which, in turn, are linked to better health later in life (Langford et al., 2015; McIsaac et al., 2017; WHO Expert Committee, 1997). The HPS framework takes an eco-holistic approach to create a school environment that is conducive to health and healthy behavior (Langford et al., 2015; McIsaac et al., 2017). One of The Children's Health, Activity and Nutrition: Get Educated! (CHANGE!) conducted by Fairclough et al (2013) positively affected body size and light physical activity outcomes, and was most effective at influencing body size outcomes among overweight and obese children and women (Fairclough et al., 2013). This is one of the programs that can be adopted to be implemented in Indonesia, especially to build HPS.

UNICEF in collaboration with Surabaya of Nahdlatul Ulama University (UNUSA) conducted an orientation program for the Nutrition and Health Intervention component program in the JHS/MTs for Teachers in Kediri City, East Java, Indonesia. The objectives of this activity are introduce the objectives, strategies and steps for implementing the youth nutrition program for Healthy JHS/MTs, discuss the implementation plan of the youth nutrition program for Healthy Schools/Madrasah (policies, systems and management, budget, facilities, capacity and human resources) in schools, increase the capacity of teacher facilitators in schools District/City level regarding adolescent nutrition and health issues; and provide increased capacity for participatory facilitation and the role of facilitators in training JHS/MTs students or adolescent nutrition cadres.

METHOD

The PHS orientation program in JHS/MTs in Kediri District was held for 2 days, Monday to Tuesday, 30th-31st May 2022 at the Kediri City Government Office. This activity was attended by 10 teachers from JHS, 4 teachers from MTs, 1 representative from the Health Authorities, 1 representative from the Regional Development Agency of Kediri District, and 3 representatives from the Education Authorities. The details of the participants who took part in the activity can be seen in table 1.

Table 1. Participants of the Nutrition and Health Intervention Orientation

No.	Name of	Participating
1.	State Junior High School 2 Kediri	2 Teachers
2.	State Junior High School 3 Kediri	2 Teachers
3.	State Junior High School 7 Kediri	2 Teachers

4.	MTsN 1 Kediri	2 Teachers
5.	MTsN 2 Kediri	2 Teachers
6.	Health Authorities	1 person
7.	Regional Development Agency of Kediri District	1 person
8.	Education Authorities	3 people

Facilitators in this orientation activity were facilitators from the School Health Unit (SHU) Development Team of Kediri district (representatives of the Education Authorities, Ministry of Health, and selected health center nutritionists). The discussion presented in these health orientation programs were nutrition education, and fostering a healthy environment by discussing a follow-up plan by each school. This follow-up plan was used as a reference in implementing the Health School in JHS/MTs program in each school. At the end of the program, participants were asked to present and discuss the follow-up plan which was then agreed upon by each school to be implemented. The participants were enthusiastic in participating in this coaching program, then UNICEF together with UNUSA carried out monitoring and evaluation for the achievement of the program in the following year.

RESULTS AND DISCUSSION

The results of the orientation activities for the nutritional intervention component in the healthy madrasah school program in Kediri Regency are in the form of follow-up plans in the implementation of healthy JHS/MTs in each school. The results of the follow-up plan are presented below:

<p align="center">Follow-up Plan for State Junior High School 2 Kediri Youth Nutrition Orientation Activities in Healthy Schools/Madrasah Programs for Teachers in Kediri City 30-31 May 2022</p>						
Activities	Method	Time	Target	Executor	Source of Funds	Expected Results
Blood Add Tablet						
Advocacy	Coordinate with school principals regarding the provision of iron tablets	at the beginning of each year	principals	SHU teacher, and Youth Health Cadre	health center	All iron tablets can be distributed to all students.
Coordination	the Principal, SHU Teachers, School Staff and Youth Health Care	At the end of each month	teachers, all female students,	SHU teacher, and Youth Health Cadre	Situational	Activities for the distribution of iron tablets must be carried out regularly
Socialization	socialization/briefing to all teachers and all school members through morning assembly in school	SHU and teacher meetings for	all teachers and school residents	SHU teacher, and Youth Health Cadre	Situational	all school residents, especially women and female students, can carry out drinking activities
Implementation	of SHU and Youth Health Care teachers distribute iron tablets to all female students and to school	Every Friday at the first hour	All female students and all school members, especially female students	SHU teacher, and Youth Health Cadre	Situational	All school members, especially girls and children, can get iron tablets regularly.

	residents, especially girls					
Recording and reporting of	Youth Health Care records the distribution of Blood Booster Tablets and then reports it to the SHU teacher for recap.	Each finished the distribution of Blood Booster Tablets on Friday morning.	All female students and all school members, especially girls.	SHU teacher, and Youth Health Cadre	Situationa 1	Youth Health Care provide concrete data to be given to SHU teachers as an annual report.
Nutrition Education						
Advocacy for	school principals, school staff and SHU teachers a	few days before summoning all canteen officers.	All school members	SHU Teachers	Situationa 1	Nutrition improvement program for students can be implemented.
Planning and budgeting	Drafting/proposal for better canteen financing	planning takes 3 days.	All canteen staff and officers responsible for canteen management.	School staff and SHU teachers	Situationa 1	all canteens can sell nutritious food for students.
Coordination	Coordination with school principals, school staff, health centers, canteen guards and SHU teachers	Determined by school staff after that proceed to the head of the school,	all canteen officers and all officers in charge of the canteen.	Community Health centers, canteen staff and SHU teachers	Situationa 1	Coordination results can be realized and can be implemented.
Nutrition Education Orientation	Conduct training/workshop on balanced nutrition.	Early June, early August, early January, early March	and	SHU Teachers	Situationa 1	All school employees can understand and understand the importance of Balanced Nutrition.
Implementati on of nutrition education	The school conducts training on nutritious food	according to the schedule	All school residents	SHU teachers and canteen in charge.	Canteen	All school residents, whether students, teachers or the person in charge, can run in balance.
Implementati on of nutrition education	The school conducts training on nutritious food	according to the schedule	All school residents	SHU teachers and canteen in charge.	Canteen	All school residents, whether students, teachers or the person in charge, can run in balance.
Healthy Environment Development						
Preparation	All school residents bring cleaning equipment	Every Friday	all school residents and school environment	All school residents	-	is hoped that the school environment will be clean and healthy
Training	holds clean and healthy Friday activities	every Friday morning	All school residents and school environment	Teachers, students and assistants Implementer	-	All school residents participate in clean / healthy Friday

activities. School activities (competition, etc.)	hold cleanliness competitions per class, hold poster competitions about balanced nutrition.	Once every 3 months	all classes and school environment	All students and teachers	Each class	all residents can maintain a healthy school environment and maintain it.
Healthy Canteen Development	Coordination between principals, staff, canteen keeper and canteen in charge	Every 4 Months	All guards and person in charge of the canteen	Nutritionist from the Community Health centers, the person in charge of the canteen, SHU teacher	-	All canteen managers maintain the quality of healthy and nutritious food sold.
School Yard Maintenance (School Gardens)	The school held activities about growing vegetables in Hydroponics.	Once a month	All school residents	All school residents	-	Schools can plant various types of vegetables and later can be distributed to school residents.
Monitoring and evaluation	Forming a committee to assess the efforts of school residents in maintaining the school environment	Once every 3 months	all school residents and the school environment	Principal, school staff, teachers, SHU teachers and implementing assistants	-	The school environment is kept clean so as to create a healthy environment.

**Follow-up Plan for State Junior High School 3 Kediri
Youth Nutrition Orientation Activities in Healthy Schools/Madrasah Programs
for Teachers in Kediri City
30-31 May 2022**

Activities	Method	Time	Target	Executor	Source of Funds	Expected Results
Blood Add Tablet						
Advocacy	SK Principals	Per Year	All Teachers, SHU and Youth Red Cross	Trustees SHU and Youth Red Cross	-	Free of Anemia
Coordination	face Meeting	Every Month	All Teachers, SHU and Youth Red Cross Trustees, and Guardians of Students	Advisors SHU and Youth Red Cross and Youth Health Care	-	All Realized and Distributed to Students
Socialization of	Notification	New Teachings	Students	SHU and Youth Red Cross Coaching	-	Understand the Importance of Blood Booster Tablets
Implementation	taking iron tablets together	every Friday morning	All	SHU and Youth Red Cross coaches students and	Blood Booster Tablets cadres from the Health Center	Free of Anemia

Recording and reporting	Write	every Once a month	Health Centers	the SHU and Youth Red Cross Supervising	-	Accurate Data
on Nutrition Education						
Advocacy	of Principal's Decree	Per Year	All Teachers, SHU and Youth Red Cross Trustees	Team in charge of nutrition education (SHU and Youth Red Cross coaches	-	It is hoped that all are not lacking in nutrition
Planning and budgeting	Determine the team in charge of nutrition education	per year	Principals, teachers, employees, and Students who	coach SHU and Youth Red Cross	-	It is hoped that all are not lacking in nutrition
Coordination	meetings of internal coordination	Once a month	Principals, teachers, employees, and students	coaches SHU and Youth Red Cross	-	It is hoped that all are not
Routine	malnourished to school health cadres or other teachers according to class needs	a month	Principals, teachers, employees, and	Youth Red Cross	-	It is hoped that all are not lacking
nutrition	in	Once	SHU	Coach and Youth Red Cross	-	is hoped that all are not lacking in nutrition
monitoring g and evaluation of	face-to-face and monthly reports	SHU	-	and Youth Red Cross coaches and cadres	Accurate	Data
for Healthy Environment Development						
Preparation	<ul style="list-style-type: none"> Planning activities involving students and school management Budgeting in schools for activities 	Every Friday Morning	School Environment	All School Residents	-	Healthy and Clean School Environment
Training	Directly Plunge into the Field	Every Friday Morning	School Environment and Surroundings	All School Residents	-	Healthy School Environment and Clean
School activities (competitions, etc.)	<ul style="list-style-type: none"> Competitions between students , socialization at school Adiwiyata activities 	Every 6 Months Every Friday	School Environment and Around	Learners	-	Healthy and Clean School Environment
Healthy Canteens	Coaching of Canteen Principals and Canteen Keepers	Once	Canteen School	Canteen Team and	-	Healthy and Clean Canteen Environment

				Schools Involved		
Maintenance of School Yard (School Gardens)	Coaching of School Cleaning Officers	Every Month	School Environment and Surroundings	Guidance of School Cleaning Officers	-	Healthy and Clean School Environment
Monitoring and evaluation	Face to face and	Reports Once a Month	School Environment and Surrounding	All Teams Involved in It	-	Accurate Data

**Follow-up Plan for State Junior High School 7 Kediri
Youth Nutrition Orientation Activities in Healthy Schools/Madrasah Programs
for Teachers in Kediri City
30-31 May 2022**

Activities	Method	Time	Target	Implementer	Source of Funds	Results What is expected
of Blood Add Tablets						
Advocacy	Reporting to the school principal regarding the activities of the	month	Principal	SHU		Advocacy
Coordination	of SHU supervisors and SHU officers in collaboration with Wli Kels and SHU cadres	January	SHU teachers, SHU cadres - SHU	teachers and SHU cadres		Coordination
of Socialization	-The coach and SHU officers provide socialization -	July	-Students and students	-Teachers -Cadres		Socialization of the
Implementation	of Giving Directly	-Every Friday at 07.30	, female students,	teachers and cadres		Implementation
of Recording and reporting						Recording and reporting
Nutrition Education						
Advocacy	Principal	July	All school residents School	Teachers	SHU	Nutrition improvement program for students can be implemented
Planning and budgeting	make proposals	July	All canteen officers and officers responsible for canteen management	cadres	school	Activities can run smoothly and sell nutritious food
Coordination	Coordination with the	July	All canteen officers and all	school staff and SHUr teachers All	school	canteens sell nutritious food

	principal, school staff, school cafeteria guards		responsible officers for			
Orientation Nutrition education	discussion forum	1 year	Student	Cadres	School	Shiva understands the importance of nutritious food
Implementation Nutrition Education	Directly	3 months	Students	Teachers and	School	Supervision
Monitoring and evaluation	of visits	from	students	cadres	school	carried out periodically
Healthy Environment						
Preparation	-Circular Letter Decree	-July	Teacher	Teachers, School Cadres	school	Clean
Training	Circular		Teachers	cadres	School	Conducted training
School activities (competitions, etc.)	Circular Letter Decree	Anniversary event on September	Teachers	cadres	School	Increase knowledge
Healthy Canteen Development	Decree	July	School canteens	Teachers,	Schools	Implemented healthy canteens
Maintenance of School Yards (School Gardens)	Decree	July	Teachers and students	cadres	School	Healthy schools, beautiful and Clean
Monitoring and evaluation	of Decision Letters	time	Teachers and students	Cadres	School	Conducted monitoring and evaluation, therefore the environment becomes healthy

**Follow-up Plan for MTsN 2 Kediri
Nutrition Orientation Activities in Healthy Schools/Madrasah Programs
Youth Teachers in the City of Kediri
May 30-31 2022**

Activities	Method	Time	Target	Executor	Source of Funds	Expected results
Blood Add Tablet						
Advocacy	Reporting to the Head of Madrasah regarding the activity of giving iron tablets to students	In January the 3rd week and July the 3rd week, the	School Principal	and SHU Officers	-	The Madrasah Head urges all students to drink Blood Booster Tablets every week 1x

Coordination	of SHU Supervisors and SHU officers in collaboration with homeroom teacher and SHU cadres	Month January 3rd week and July 3rd week	Homeroom and SHU Cadres SHU	coaches and SHU Officers	-	students will receive and drink Blood Booster Tablets
Socialization	SHU coaches and officers provide socialization about the importance of Blood Booster Tablets through homeroom teachers to all students and parents through community groups and student groups	in July	Students and parents	SHU coaches and SHU officers	-	Students and parents understand the importance of Blood Booster Tablets
implementation	SHU Cadres is assisted by SHU coaches and officers giving Blood Booster Tablets to female students	1x a week every Friday	All female students	SHU cadres are assisted by SHU coaches and officers	-	Every female student understands about Blood Booster Tablets and drink it
Recording and reporting	SHU coaches and SHU officers assisted by SHU Cadres record and report to southern city health centers	1 month 1x	Southern City Health Center	SHU coaches, SHU officers and SHU cadres	-	All activities giving iron tablets have been documented and can be evaluated
Education Nutrition						
Advocacy	Coaches report to the Head of Madrasah about nutrition education activities	prior to the implementation of the orientation period for new students.	Head of Madrasah	SHU Superintendent and SHU officers	. -	Head of Madrasah permits and supports nutrition education activities.
Planning and budgeting of	SHU coaches makes proposals for nutrition education activities and submits it to the treasurer of the boss	prior to the implementation of the period. new student orientation	BOS Treasurer	SHU Trustees	Fund	Madrasah Bosses support budget for nutrition education activities
Coordination	in collaboration with Southern City Health Centers	prior to the implementation of the new student orientation period	Southern City Health Center	SHU Trustees	-	South Region City SHU parties are willing to provide material related to nutrition education to students

nutrition education orientation	SHU coaches provide orientation on nutrition education activities to SHU cadres and homeroom teachers	prior to the implementation of the new student orientation period	SHU	coaches	-	cadres and homeroom teachers understand regarding the implementation of nutrition education activities.
Implementation of nutrition education	-Southern City Health Center provides materials related to nutrition education during the orientation period for new students - Breakfast activity with a balanced nutrition menu.	July during the orientation period	7th grade students	South Region City Health Center Officer and SHU Supervisor	-	Students understand the importance of nutrition education and the importance of breakfast with a balanced nutrition menu.
Monitoring and evaluation	SHU coaches identify the results of monitoring and evaluation of nutrition education activities	After implementing nutrition education activities,	SHU coaches and SHU cadres, SHU	coaches		The SHU supervisor can identify the results of monitoring and evaluation of nutrition education activities for follow-up plans for the following year's activities.
Healthy Environment Development						
Preparation	SHU coaches coordinate with SHU cadres, homeroom teachers and OSIS to prepare for the class cleaning competition	Prior to the Class meeting	SHU cadres, homeroom teachers and OSIS	SHU coaches	-	SHU cadres, homeroom teachers and OSIS understand the preparation for class cleaning competitions
training	SHU cadres related to implementation Class cleaning competition	to the implementation of the Class meeting	SHU	- SHU	cadres	the implementation of competitions
School activities (competition etc.)	Competition activities	SHU	coaches	Cadres	understand	Prior
Healthy Canteen Development	The supervisor of the School Health Unit in collaboration with the community health center of the Southern City held a healthy	July	Madrasa canteen managers and canteen officers	SHU supervisors and Southern City Health Center officers	School Operational funds	Canteen managers understand the importance of healthy

	canteen development activity					
Maintenance of School Yards (School Gardens)	Maintain plant yard	Clean Friday Activities	All Madrasah residents	All Madrasah residents	-	All Madrasah residents can take good care of plants in Madrasahs
Monitoring and evaluation	SHU coaches monitor and evaluate healthy environment	development activities after healthy environment development activities	Madrasah	the SHU Trustees	-	coaches can monitor and evaluate for the next year's activity plans.

**Follow-up Plan for MTsN 1 Kediri
Youth Nutrition Orientation Activities in Healthy Schools/Madrasah Programs
for Teachers in Kediri City May 30-31 2022**

Activities	Method	Time	Target	Executors	Source of Funds	Expected Results
Blood Adding Tablets						
Advocacy	Direct Discussion	Beginning of the odd semester, July 2nd week	School Principal	SHU		formation of a commitment according to
coordination	teacher, student council, Youth Red Cross, Shu	July 3rd week	All female students	SHU, Youth Red Cross, Shu members		Understanding the importance of Blood Booster Tablets
Socialization	Counseling	July 4th Week	All female students	SHU Member, Youth Red Cross, Shu		Information conveyed
Implementati on	Direct	July 4th Week	All female students	SHU Member, Youth Red Cross, SHU		Rematry for consumption of iron tablets
recording and reporting	Direct	on Friday 4th week	Female students	SHU members		Retrieved data obtained by consuming Blood Booster Tablets
Nutrition Education						
Advocacy	Direct Discussion	August 2nd week	Headmaster of MTs	Vice school of public relations, SHU supervisor		Decree of the implementing committee for
planning and budgeting	of	August 3rd week	Headmaster of MTs discussion, Implementing activities	Nutrition education Team		Availability of the budget for the
Coordination of	Discussions and consultations	for the 3rd week of August.	Organizing committee, health center,	Team of Nutrition Education		training plan

orientation	Direct nutrition education program	September 2nd week	All madrasah residents	Nutrition education team		Nutrition education program delivered
Implementation of nutrition education	Training	September week 4	All madrasa residents	Nutritionist from Community Health centers		Implementation of training
Monitoring and evaluation	Reports and observations	November 2nd week	Madrasah	the SHU Superintendent		The purpose of implementing the activity can be achieved
Healthy Environment Development						
Preparation	Elections of Youth Health Care	October 1st week	Students	Healthy Environment Development Team		Youth Health Care Members
Training	Training on healthy canteens and school yards	October 2nd week	Youth Health Care, canteen staff, School cooperative, school cleaning and community	health center		Implementation of training
School activities (competition etc.)	Healthy food menu competition, class cleanliness	October 3rd Week	Students	Healthy environment development team, SHU coaches, Youth Health Care		Competition
Healthy Canteen Development	Delivery of a healthy canteen to madrasa residents	October 4th Week	All madrasah residents	Healthy environment development team, SHU coaches, Youth Health Care		Good delivery of the program
Maintenance of School Yards (School Gardens)	Clean Friday	October 4th week	All madrasa residents Madrasa	residents, cleaning staff		school yard is well maintained and beautiful
Monitoring and evaluation	Reports and observations	November 1st week	All activities for fostering a healthy environment	Community Health centers, SHU supervisors		The purpose of the activity was achieved. The

Implementation of healthy school orientation activities for nutrition and health components includes Blood Booster Tablets, Nutrition Education, Healthy Environment Development with the hope that it can be applied to all school health components such as School Health Units (SHU), Youth Health Cadres, Community Health Centers, and all staff in the school environment. Multicomponent interventions in schools that combine educational, curricular, policy, and environmental elements are considered more effective than interventions that target single components or behaviors (McIsaac et al., 2017). Understanding and applying

nutritional knowledge and skills to all aspects of health is essential, and all professions need basic training to assess food intake effectively and provide targeted guidance, counseling and treatment (DiMaria-Ghalili et al., 2014).

Appropriate health knowledge and adequate motivation for health activities are key factors influencing individuals to adopt healthy behaviors. Health promotion positively influences progressive behavior that seeks to advance health potential, to continuously improve one's lifestyle (Liao & Bercea, 2021). There are many indications that health promotion continues to encourage people to eat healthier foods. The formulation and implementation of health promotion strategies must be combined with key success factors to achieve goals (Liao & Bercea, 2021). The Health Promoting School Approach (HPS) aims to make schools a healthy place through a holistic approach that promotes a 'school ethos' that supports and emphasizes improvements in physical, social, and emotional well-being and educational outcomes (McIsaac et al., 2017).

Based on the results of monitoring and evaluation, as well as program follow-up activities, it can be seen that collaboration between health education and health literacy disciplines can strengthen education, promote health improvement, and encourage dialogue between school officials, public health officials, teachers, parents, students, and others. stakeholders (Auld et al., 2020). This is in line with UNICEF's ideals. The HPS evaluation should continue to explore implementation steps, gather detailed information about the school environment to help interpret the observed outcomes, and consider measures of student well-being as a result. Furthermore, long-term and longitudinal studies are needed to demonstrate the potential effects of HPS on students' health, well-being, and academic achievement into the future (Liao & Bercea, 2021; McIsaac et al., 2017; Xu et al., 2019).



Figure 1. Activity program of nutrition intervention component

KELANTAN



Figure 2. Implementation of the healthy school orientation of the Kediri Regency with UNICEF team



Figure 3 Participants of nutrition and health orientation program for health school in Kediri district

CONCLUSION

Based on the results of the overall implementation of the Nutrition and Health Intervention Component Orientation activities in the School Program/ Healthy Madrasas for teachers in the City of Kediri can be concluded that in general the activities run smoothly and according to the planned schedule and coordination in the implementation of activities both between UNUSA, UNICEF, facilitators, and participants can be carried out more optimally. The implementation of the nutrition and health component orientation in schools will continue to be carried out and developed in other districts in East Java.

ACKNOWLEDGMENT

Sincere thanks to UNICEF and the UNUSA Research and Service Institute for funding the orientation of PHS program in Kediri district. Thanks to Regional Development Agency of Kediri District, Education Authorities and Health Authorities of Kediri District for supporting this activity.

REFERENCES

- Auld, ME, Allen, MP, Mickalide, AD, & Logan, RA (2020). *Health Literacy and Health Education in Schools: Collaboration for Action*. <https://www.cdc.gov/healthyschools/>
- DiMaria-Ghalili, RA, Mirtallo, JM, Tobin, BW, Hark, L., van Horn, L., & Palmer, CA (2014). Challenges and opportunities for nutrition education and training in the health care professions: Intraprofessional and interprofessional call to action. *American Journal of Clinical Nutrition*, 99(5). <https://doi.org/10.3945/ajcn.113.073536>.
- Fairclough, SJ, Hackett, AF, Davies, IG, Gobbi, R., Mackintosh, KA, Warburton, GL, Stratton, G., van Sluijs, EMF, & Boddy, LM (2013). Promoting healthy weight in primary school children through physical activity and nutrition education: A pragmatic evaluation of the CHANGE! randomized intervention study. *BMC Public Health*, 13(1). <https://doi.org/10.1186/1471-2458-13-626>.
- Ministry of Health of the Republic of Indonesia. (nd). *Obesity Epidemic*.
- Langford, R., Bonell, C., Jones, H., & Campbell, R. (2015). Obesity prevention and the Health promoting Schools framework: Essential components and barriers to success. *International Journal of Behavioral Nutrition and Physical Activity*, 12(1). <https://doi.org/10.1186/s12966-015-0167-7>.
- Liao, CH, & Bercea, S. (2021). Success factors of health promotion: Evaluation by DEMATEL and M-DEMATEL methods - A case study in a non-profit organization. *PLoS ONE*, 16(12 December). <https://doi.org/10.1371/journal.pone.0260801>.
- McIsaac, JLD, Penney, TL, Ata, N., Munro-Sigfridson, L., Cunningham, J., Veugelers, PJ, Storey, K., Ohinmaa, A., Kirk, SFL, & Kuhle, S. (2017). Evaluation of a health promoting schools program in a school board in Nova Scotia, Canada. *Preventive Medicine Reports*, 5, 279–284. <https://doi.org/10.1016/j.pmedr.2017.01.008>.
- UNICEF Indonesia. (nd). *What we do Every child comes first*. <https://www.unicef.org/indonesia/what-we-do>.
- UNICEF Indonesia. (2022, March 4). *Indonesia: The number of people who are overweight and obese is rising across all age and income groups*. https://www.unicef.org/indonesia/id/press-releases/indonesia-angka-orang-yang-kelebihan-berat-badan-dan-obesitas-naik-di-semua-kelompok?Gclid=Cj0KCQjwteOaBhDuARIsADBqRejugG4hUXuAVdyWD9tV6_isqQrdGzB93AsAKVBXvBCFtdyJMHS8zIEaAgb4EALw_wcB.
- WHO Expert Committee. (1997). *Promoting Health Through Schools*.
- Xu, Q., Chen, B., Jin, D., Yin, L., & Huang, Y. (2019). An assessment for health education and health promotion in chronic disease demonstration districts: A comparative study from Hunan Province, China. *PeerJ*, 2019(3). <https://doi.org/10.7717/peerj.6579>.

Model for Representation of People's Malay Identity Guided by Gurindam Duabelas Raja Ali Haji

Asrinda Amalia

*Faculty of Communication Science, Universitas Muhammadiyah Riau,
Pekanbaru 28000, Indonesia*

*Faculty of Language Studies and Human Development, Universiti Malaysia Kelantan,
Bachok, Kelantan 16300, Malaysia
asrinda.amalia@umri.ac.id*

Nur Azuki

*Faculty of Language Studies and Human Development, Universiti Malaysia Kelantan,
Bachok, Kelantan 16300, Malaysia
nurazuki@umk.edu.my*

Hevi Susanti

*Faculty of Language Studies and Human Development, Universiti Malaysia Kelantan,
Bachok, Kelantan 16300, Malaysia
e19e0049f@siswa.umk.edu.my*

ABSTRAK

Kemajuan teknologi dan globalisasi telah mengakibatkan krisis sosial. Krisis sosial telah menyebabkan manusia mengalami persaingan yang tidak adil, rasuah, perang saudara, kemerosotan moral, dan berlakunya pelbagai tindakan keganasan. Akibat langsung adalah hilangnya nilai kemanusiaan, sehingga manusia pula akan kehilangan akar tradisinya, bahkan identitinya. Aliran pemodenan menyebabkan masyarakat khususnya golongan remaja mula meninggalkan budaya tempatan dan beralih kepada budaya luar yang dianggap lebih mewakili diri sendiri. Hal ini tentunya memberi impak kepada perubahan gaya hidup dan pemikiran sebagai orang Melayu. Maka tujuan penelitian ini adalah menyatakan representasi jati diri orang Melayu dalam makna teks yang terkandung dalam kesusasteraan Gurindam Dua Belas karya Raja Ali Haji. Ini perlu diteliti sebagai satu bentuk sumbangan kepada pembangunan mental dan pembinaan sahsiah. Kajian ini berbentuk deskriptif dengan kaedah analisis kandungan. Data penyelidikan ini bersumberkan Gurindam Dua Belas. Berdasarkan pengamatan penulis, Gurindam Dua Belas menyumbangkan nilai-nilai budaya dan akhlak termasuk tanggungjawab, taat, menasihati, menghormati, menyayangi, dan taat setia kepada manusia khususnya bangsa Melayu.

Keywords: *gurindam dua belas; masyarakat malay; identiti, raja ali haji, representasi*

ABSTRACT

Advances in technology and globalization have resulted in a social crisis. The social crisis has caused humans to experience unfair competition, corruption, civil war, moral decline, and the occurrence of various acts of violence. The direct result is the loss of human values, so that humans in turn will lose their traditional roots, even their identity. The flow of modernization has caused people, especially teenagers, to start leaving the local culture and switching to an outside culture that is considered more representative of themselves. This of course has an impact on changing their lifestyle and mindset as Malay people. So the purpose of this research is to state the representation of the Malays people identity in the meaning of the text contained in the Gurindam Dua Belas literature by Raja Ali Haji. This needs to be researched as a form of contribution to mental development and character building. This research is descriptive with content analysis method. The data of this research is sourced from Gurindam Dua Belas. Based

on the author's observations, the Gurindam Dua Belas contributed the values of culture and morals including responsibility, obedience, advising, respecting, love, and loyalty to humans, especially the Malay people.

Keywords: *gurindam dua belas; malay people; identity, raja ali haji, representation*

INTRODUCTION

The Indonesian nation actually has character values that are reflected in the traditions and customs of its people. These character values become the moral foundation and become a way of life for the local community. These life values then develop in society and are known as local wisdom (Aji 2019). Therefore, the values of local wisdom must be revived among people such as Malay people. As is the case with Malay culture. Malay culture is a culture that highly upholds the value of politeness, which is one of the commendable principles of Malay identity. In everyday life, manners are one of the benchmarks for judging someone. (Marlina 2020)

The importance of politeness in the lives of the Malays, causes them to try their best and endeavor to make themselves people of commendable character, noble character based on faith and piety. Adhering to the principle of life and upholding politeness causes the Malays to be famous not only for their abundant natural wealth, but also known and respected for their politeness, openness and hospitality. That is why the values of politeness are taught from an early age, instilled into the hearts of their children so that they become people, namely to be polite, virtuous, have noble character, beautiful in appearance and good in mind. In life, humans cannot separate themselves from the life of a household, society, nation and state. Life requires association, both in a limited and open and wide scope. Therefore, Malay culture provides teaching and learning about the association, especially in social interactions involving many people, tribes and nations. Malay elders with all their wisdom and wisdom, have succeeded in collecting, screening, sifting and standardizing the noble values they have, especially from their main source, namely the teachings of Islam. These values, which are complemented by their Islamic cultural values, are poured into teaching and learning forms, which are then passed down from generation to generation. With these values, they are able to realize peace and prosperity and life in a household, community, nation and state. (Marlina 2020)

The diversity of Indonesian literary works can be seen by the many works of regional literature. Regional literary works are very well known, one of which is Malay literature. Today many young people do not know the old Malay literary works, some even do not understand the meaning contained in them. This is because old literary works use complex language and also local languages that can only be understood by the people of the area, making it difficult for other people to understand. Whereas literary works are conveyed through language, language is part of culture so that it cannot be separated.

An understanding of the meaning contained in a literary work is very rare to be studied more deeply scientifically. Moreover, understand the aspects of culture, religion and even moral values contained in the literary work. It must be admitted that literary works that are born are usually imbued with strong cultural values and are based on high religious values. So that the literary sentences that are born have a moral message based on religious and cultural values.

If we read some of the works of previous writers, such as Buya Hamka through his masterpiece novel *Under the Protection of the Ka'bah*, it will be clearly illustrated how a Buya Hamka interprets the value of love and loyalty which is based on high Islamic values and

upholds customary norms. The literary work *Under the Protection of the Ka'bah* talks about the love story between Hamid and Zainab who both fall in love but are separated due to differences in social background until Zainab is confronted by her mother's request to marry the man she has chosen. At the end of the story, Hamid decides to go to Mecca, then continue to worship until he finally dies in front of the Kaaba after learning that Zainab has died. So great is the wrapping of Buya Hamka's sentence that it tells the love of two people who are full of Islamic values and uphold social cultural values so that it becomes a novel of high value.

Likewise, literary works in the form of poetry are also full of meaning so that these works are never obsolete and timeless. For example, of Tenas Efendi in *Tunjuk Ajar Melayu*, where it contains various noble values that can be used as guidelines and will lead to life, which is full of noble values of religion and Islamic culture. It is these values which, when digested and internalized, and practiced sincerely, will become their Malay identity. By adhering to that identity, every human being will become a person, namely being a human being who is commendable, reliable, counted, skilled, wise and wise, knowledgeable, broad-minded, virtuous, has dignity and worth, good luck and dignity, who, God willing, bring physical and spiritual prosperity in the life of a household, society, nation and state (EFFENDY).

Gurindam also turned out to be a literary work of poetry that is timeless, it is proven that in 2010 a young writer from Tanjungpinang City named Rendra Setyadiharja wrote a gurindam entitled *Gurindam Mutiara Hidup*. From the results of previous research studies, it can be concluded that, from a total of 201 gurindam stanzas in Rendra Setyadiharja's *Gurindam Mutiara Hidup*, there are 80 stanzas on the ontological aspect and 119 stanzas on the psychological aspect and 2 stanzas that are not included in the ontological and psychological aspects (SETYADIHARJA).

The same thing can also be seen in old Malay poetry literary works such as *Gurindam Dua Belas* by Raja Ali Haji. Of course, the literary works in *Gurindam Dua Belas* contain many meaningful messages so that they have meaning for people's lives, especially the Malay community in the Riau region and the Riau Islands.

In Malay historical records, the reason Raja Ali Haji created the gurindam was as a dowry given to Engku Puteri Hamidah who lived on Penyengat Island (Anastasia 2012) This dowry was carved in marble as a testament to his love. In the words contained in the gurindam, there is a very strong Islamic nuance because the gurindam contains very useful and universal advice and advice for the community, especially the community where Raja Ali Haji lives, namely the Malay community. This is possible because of the dominant element of Islam in social life in Malay culture as a result of the smooth process of Islamization (Haji 2022).

In the midst of the development of communication and information technology today, it also has an impact and concern for the fading of the dominance of Islamic elements in the life of the Malay community. This century is also a century where everything related to social dynamics cannot last long (Chan, Stukus et al. 2018).

Gurindam Dua Belas is one example of gurindam that has developed in society today. *Gurindam Twelve* was created by Raja Ali Haji. Gurindam, which is full of Islamic guidance, is often sung at Malay cultural events in villages and towns and contains invitations (advice and advice) for goodness. In addition to containing religious teachings, this gurindam also contains criticism and invitations to goodness. Like an invitation or advice to navigate life in the world. Navigating life here is not only in living life, but also at the same time understanding

the rules in it to get blessings from God. In addition, there is also an invitation to learn about religion, what is meant by learning is not just studying religious shari'ah without practicing it in daily life because this will only make someone good at speaking theoretically without being able to set a good example (Haji 2022).

Gurindam Dua Belas believes that every verse in the gurindam is pleasing to the ear and very touching to the heart. According to Rosidi's opinion (Rosidi 1998), in this case, it is argued that the literary and cultural experience of the region or regional tribes as well as other tribes is a bridge to understand each other, thus being able to understand regional language literary works is not only judged because it is enjoyable because it is enjoyable. will reduce the benefits of the literary work, but also understand the meaning and purpose of valuable messages and benefits for the audience. Moving on from this assumption, research on Gurindam Dua Belas especially symbols and meanings based on language codes, literary codes, and cultural codes needs to be studied to find out symbols and meanings based on language codes, literary codes, and cultural codes in Gurindam Dua Belas because all of its contents contain various teachings. From basic teachings to higher teachings. Basically, Gurindam Dua Belas uses a simple Malay language and also uses Arabic. It is said to be simple because Indonesian comes from the Malay language so that it is easily understood by people in general. However, behind the simplicity of the language, it is suspected that Gurindam Twelve contains symbols and meanings so that the meaning cannot be interpreted only by understanding. For this reason, this study seeks to examine meanings and symbols based on language codes, literary codes and cultural codes in Gurindam Dua Belas. Several other research results show that there are moral values contained in Gurindam Dua Belas: (1) the moral values of human life with oneself which include: wisdom, simplicity, honesty, courage to live, and vigilance in life, (2) moral values of life human beings with other people which includes: loyalty to fellow human beings, togetherness in life, and respect for others, (3) the moral values of human life with God which include: believing in God and istiqomah, (4) the author's way of conveying moral values which include: direct delivery of moral values and indirect delivery of moral values. Another research is the research of Siti Maryam Purwoningrum (Purwoningrum 2013), entitled The Pragmatic Study of the Gurindam Dua Belas Manuscripts by Raja Ali Haji. The results of this study indicate that the pragmatic study of the Gurindam Dua Belas manuscripts by Raja Ali Haji resulted in twelve aspects contained in the Gurindam manuscripts. Among them are the teachings of faith, the teachings of makrifat, to how to become a good leader.

THE VALUES OF GURINDAM DUA BELAS BY RAJA ALI HAJI

The word gurindam comes from the Tamil language which means "for example". Gurindam is an old Malay poem consisting of two lines of sentences with the same ending rhythm with a unified whole. Gurindam usually consists of two compound sentences divided into two rhyming lines. Each line is a compound sentence which is a main and a subordinate clause. The number of syllables in each line is not determined. The rhythm is also not fixed (Anastasia 2012). Cultural values appear in symbols, slogans, mottos, visions, missions or something that looks like a reference main motto in an environment or organization. There are three things that concerning cultural values, namely: First the symbols, slogans or others that are visible to the naked eye. The second is the attitude of behavior, the movements that arise as a result of the slogan, motto The three beliefs that embedded that takes root and becomes frame of reference in action and behave. (Kurmalasari and Hamdan 2017)

Gurindam has certain characteristics, namely: *first*, double. Gurindam has two rows in a row or several rows in a row. Each line in duplicate is the content or intent and needs to be

continued with the lines in the next duplicate to carry the complete meaning. The first line is usually known as “condition” and the second line as “answer”. The first line or "condition" states a thought or event while the second line or "answer" states information or explains what has been stated by the first line or verse. *Second*, words. The number of inline words is not fixed. *Third*, syllables. The number of syllables is not fixed. *Fourth*, Rima. The ending rhyme is not fixed (Anastasia 2012).

Raja Ali Haji, mentions the meaning of the gurindam in the introduction to his work. The introduction also mentions the date the gurindam was written, the benefits of the gurindam, and the difference between gurindam and poetry.

“Inilah Gurindam Dua Belas Namanya”

“Segala puji bagi Tuhan seru sekalian alam serta shalawatkan Nabi yang akhirul zaman serta keluarganya dan sahabatnya sekalian adanya.

Amma ba’du daripada itu maka tatkala sampailah hijratun Nabi 1263 Sannah kepada dua puluh tiga hari bulan Rajab hari Selasa maka diilhamkan Allah Ta’ala kepada kita yaitu Raja Ali Haji mengarang satu gurindam cara Melayu yaitu yang boleh juga diambil faedah sedikit-sedikit perkataannya itu pada orang yang menaruh akal maka adalah banyaknya gurindam itu hanya dua belas pasal di dalamnya.

Syahdan adalah beda antara gurindam dengan syair itu aku nyatakan pula bermula arti syair Melayu iaitu perkataan yang bersajak serupa dua berpasang pada akhirnya dan tiada berkehendak pada sempurna perkataan pada satu-satu pasangannya bersalahan dengan gurindam adapun gurindam itu iaitu perkataan yang bersajak juga pada akhir pasangannya tetapi sempurna perkataannya dengan satu pasangan sahaja jadilah seperti saja yang pertama itu isyarat dan syair sajak yang kedua itu jadi seperti jawab.

Bermula inilah rupa syairnya.

Ini Gurindam pasal yang pertama:

*Barang siapa tiada memegang agama,
Sekali-kali tiada boleh dibilangkan nama.*

*Barang siapa mengenal yang empat,
Maka ia itulah orang yang ma’rifat*

*Barang siapa mengenal Allah,
Suruh dan tegahnya tiada ia menyalah.*

*Barang siapa mengenal diri,
Maka telah mengenal akan Tuhan yang bahri.*

*Barang siapa mengenal dunia,
Tahulah ia barang yang teperdaya.*

*Barang siapa mengenal akhirat,
Tahulah ia dunia mudarat.*

Whenever a gurindam is mentioned, what comes to mind is none other than Raja Ali Haji's Gurindams Dua Belas. It was as if Gurindam Dua Belas were the only gurindam ever written. From articles on the internet to official school textbooks, all use Gurindam Twelve as an example. In fact, according to documents collected by Volksalmanak (OKTALISA, Aliana

et al. 2009) so many gurindams have been written, either by other authors, or by Raja Ali Haji himself.

RIAU MALAY IDENTITY

What makes a person Malay? Today, Malays would be likely to answer that a Malay is someone who speaks the Malay language, follows Malay customs and is a Muslim. Such a relatively simple answer, however, masks more complex issues. Identity is a continually evolving aspect of every individual and group, and to identify with an ethnic group involves negotiating a maze of religious, linguistic and social issues. (Barnard 2001)

The word 'Melayu' appears in seventh-century Chinese sources with reference to Sumatra, and as it has been wandering around Southeast Asia ever since, carrying with it notions of a culture, a people and location. The term may have first been used in Kalimantan, or possibly around the Melayu River on Sumatra. But then, origins are often vague in a world that is constantly undergoing transformation. (Fee 2001)

Riau historian, Prof. Suwardi, MS in his article states that in its history the Malays as immigrants, first came to the archipelago between 3000-1500 BC as old Malays and 500 BC known as new Malays. They come with their language culture as an identity that spreads from East to West (from Pas Island to Madagascar) and from North to South (from Formosa to New Zealand). From that distribution they settled in the archipelago. One of them is in the Malacca Strait area, namely the Riau islands, the coast and the islands of Sumatra and Kalimantan. At that time, the Old Malay language had developed in the Srivijaya Kingdom from the 7th century to the 14th century. The evidence can be learned from foreign inscriptions and news such as Chinese, Arabic, Portuguese, Dutch and so on. Then it was continued in the 13th century until 1928, in 1945 it was confirmed as the State language. (Suwardi and Zulkarnain 2008).

“Riau people are the majority of Malay people who live in Riau Islands and Riau Mainland, as well as having Malay cultural values. History reveals that in the past the Malays were a nation of "conquerors" and succeeded in "ruling" other tribes in the archipelago and Southeast Asia. Therefore, the characteristics of Malay are Muslim, speak Malay, and have Malay customs.” (Suwardi and Zulkarnain 2008). For the Malays, civilized individuals are those who are noble and cultured, that display high standard mannerisms that reflect peace and harmony such as being cooperating and respectful as well as being tolerant, and considerate towards the feelings of others. (Husin 2010, Zaini, Sarudin et al. 2021).

Suwardi also explained that one of the ethnic cultures that is strongly influenced by Islam is the Malay tribe. The influence of Islam on Malay culture can be found in Malay traditions and literature. However, before Islam entered the Malay lands, the Malay cultural style was Hindu-Buddhist which was influenced by the Srivijaya Kingdom around the 7th to 11th centuries AD. The majesty of Srivijaya was then continued by the kingdom of Melaka around the 14th century until the 16th century AD. After Islam spread in the Malay land, the Malay culture changed to an Islamic culture. The spread of Islam is not carried out by force but by peaceful means. Because using good methods the majority of Malays then embraced Islam.

One proof of the strong influence of Islam in Malay culture is the use of Arabic-Malay script or Jawi writing in Malay society. The use of this Arabic-Malay script can be found in

ancient texts written in the past. The existence of this script is still maintained in Malay society as a form of appreciation for the past culture.

“Malay people are known for their excellent writing traditions”. This is evidenced by the abundance of manuscripts written by Malays. One of the most famous Malay authors is Raja Ali Haji, with his masterpiece *Gurindam Dua Belas*. In this *gurindam*, it is very clear that the influence of Islam on Malay literary works. The skill of playing with words such as in poetry, rhymes, rhymes and other forms of word processing made the Malays famous for their subtlety of culture. Malays use language in an orderly manner so that the language used will be measured by taste. With this sense, the Malays guard their language. The skill of playing the language is also used to convey advice, advice, and teaching related to Islamic values. The use of poetry and rhymes feels more impressive to convey moral messages based on Islam.” (Suwardi and Zulkarnain 2008).

Malays see Islam not only as a chosen religion that is blessed by God, but they also view Islam as an identity. This view is reflected in the lives of the Malays so that the expression arises that a Malay must be Muslim, if he is not Muslim it means he is not Malay.

Identity as the elect is associated with the firmness of their faith in embracing Islam. Faith is the main basis for Malay people to worship God so that humans really believe in the teachings of Islam as a guide in life.

In this study, to see the identity of the Malay community in this case is a group of teenagers, the researcher uses the theory of of the Dimensions of Identity Formation by Michael Hecht. Regarding identity, in the communication theory of identity as a result of his thinking, Michael Hecht together with his colleagues, formed three cultural contexts, namely individual, communal, and public contexts. Hecht describes identity beyond a simple understanding of the dimensions of the self and the dimensions described. The two dimensions interact in a series of four levels or layers: (Hecht, Warren et al. 2005)

1. The first level is the Personal Layer, which consists of a sense of where we are in social situations.
2. The second level is the Enactment Layer or other people's knowledge of ourselves based on what we do, what we have, and how we act.
3. The third level in our identity is relational that who we are in relation to other individuals. Identity is formed in our interactions with other people.
4. The fourth level is the communal level, which is tied to a larger group or culture. This level of identity is very strong in many Asian cultures (Littlejohn and Foss 2010)

Hecht's theory which discusses the communication theory of identity is very different from other identity theories. We take the example of identity theory in the sociopsychological tradition. This theory thinks more about the individual as something separate, which is the core of sociopsychological theory. Or we compare it with identity theory in sociocultural theory. This theory broadens its scope to look at the ways in which a person's sense of self is a result of social life. In addition to differences with other theories of identity, in this theory of communication about identity Hecht also introduces special dimensions of identity in understanding the identity of a person or a group. The dimensions that need to be considered are the dimensions of feeling (affective dimension), thinking (cognitive dimension), action (behavioral dimension), and transcendent (spiritual).

The sustainability of Malay culture is a big challenge, because although it is still strong, its current position is less strategic and its influence is starting to decline (Abdullah and Abdul Fattah 2013). The reforms have allowed the Riau Malay population to continue to demonstrate their presence in their own area (Alfarabi, Asri et al. 2019). Ethnic Malays as a community, have the right to be involved in determining the format of Malay politics, not a community that is part of a political system based on a royal ideology that tends to be authoritarian (Jaya 2018). Malaysia and Indonesia, currently seem to not understand the historical background of the two countries. Most of the recent social and corporate challenges have been born out of cultural confusion, so even a small worry will lead to fires and flames that don't go out quickly (Zed 2016). In the sense of modernity, the Malay civilization, which has established its legacy, will become more sophisticated and at the same time be able to dominate the world's great civilizations if it can change something from domination to a hegemonic culture (Sanusi 2017). Malays want their heritage to be protected by local government policies and not used for practical politics (Asrinaldi and Azwar 2018).

CONCLUSION

Based on the results and discussion of representation of the identity of the Malays based on Raja Ali Haji's Gurindam Dua Belas laden with teaching values in the form of values culture in between Islamic religious values, behavioral guidance and self-control; and management of human thoughts and feelings. The results of the study show that all of the verses in Gurindam Dua Belas have a cohesive-coherent relationship in the form of behavioral teachings, moral guidance, and character education values that are very relevant in the past, present, and future that represent of Malay people.

REFERENCES

- Abdullah, M. A. and R. A. Abdul Fattah (2013). "Diaspora Rumpun Melayu di Muar, Johor, Malaysia."
- Aji, G. S. (2019). "Pengembangan Kurikulum Program Unggulan Di Sd Muhammadiyah Kleco Kotagede." *Jurnal Pendidikan Agama Islam* 16(1): 63-74.
- Alfarabi, V. A., et al. (2019). "Elite Lokal Dan Upaya Pembentukan Wajah Baru Identitas Melayu Di Indonesia Pascareformasi." *Jurnal Akademika* 89(3): 143-154.
- Anastasia, F. (2012). "Nilai Budaya dan Nilai Agama dalam Teks Gurindam Dua Belas Sebagai Pedoman Masyarakat." *Media Akademika* 27.
- Asrinaldi, A. and A. Azwar (2018). "Dimensi Kekuasaan Penghulu Adat Melayu Riau dalam Pelaksanaan Demokrasi Lokal." *Jurnal Antropologi: Isu-Isu Sosial Budaya* 20(1): 57-69.
- Barnard, T. P. (2001). "Texts, Raja Ismail and violence: Siak and the transformation of Malay identity in the eighteenth century." *Journal of Southeast Asian Studies* 32(3): 331-342.
- Chan, T. M., et al. (2018). "Social media and the 21st-century scholar: how you can harness social media to amplify your career." *Journal of the American College of Radiology* 15(1): 142-148.
- EFFENDY, K. T. "ANALISIS NILAI-NILAI PENDIDIKAN KARAKTER DALAM BUKU TUNJUK AJAR MELAYU."
- Fee, L. K. (2001). "The construction of Malay identity across nations: Malaysia, Singapore, and Indonesia." *Bijdragen tot de taal-, land-en Volkenkunde* 157(4): 861-879.
- Haji, R. A. (2022). *Gurindam dua belas*, Re-Publish
- Hecht, M. L., et al. (2005). "The communication theory of identity." *Theorizing about intercultural communication*: 257-278.

- Husin, W. N. W. (2010). "Budi-Islam: It's role in the construction of Malay identity in Malaysia." *International Journal of Humanities and Social Science*. Vol 1(12): 132-142.
- Jaya, A. C. (2018). "Konsep Nation-State dalam Pemikiran Ideologi Politik Melayu Islam pada Abad Ke-19 M (Studi Pemikiran Abdullah bin Abdul Kadir Munsyi (1787-1854))." *Tamaddun: Jurnal Kebudayaan dan Sastra Islam* 18(2): 134-146.
- Kurmalasari, T. and A. R. Hamdan (2017). Nilai-Nilai Karakter Building Dalam Gurindam Dua Belas Karya Raja Ali Haji, Kiprah.
- Littlejohn, S. W. and K. A. Foss (2010). *Theories of human communication*, Waveland press.
- Marlina, M. (2020). "NILAI KEARIFAN LOKAL DALAM TUNJUK AJAR MELAYU KARYA TENAS EFFENDI." *Diksi* 28(2): 199-209.
- OKTALISA, R., et al. (2009). PERBANDINGAN CITRAAN PUISI-PUISI KARYA JOKO PINURBO DALAM KEPADA CIUM DENGAN PUISI-PUISI KARYA SUTAN TAKDIR ALISJAHBANA DALAM TEBARAN MEGA, Sriwijaya University.
- Purwoningrum, S. M. (2013). "Kajian Pragmatik Naskah Gurindam Dua Belas Karya Raja Ali Haji." *Suluk Indo* 2(3): 279-293.
- Rosidi, A. (1998). *Cari muatan*, PT Balai Pustaka (Persero).
- Sanusi, I. (2017). "Globalisasi Melayu: Peluang dan Tantangan Membangun Identitas Melayu dalam Konteks Modernitas." *Tarbawiyah: Jurnal Ilmiah Pendidikan* 1(02): 34-49.
- SETYADIHARJA, K. R. "ANALISIS NILAI ESTETIKA DALAM GURINDAM MUTIARA HIDUP."
- Suwardi, M. and Zulkarnain (2008). *Dari Melayu ke Indonesia: peranan kebudayaan Melayu dalam memperkokoh identitas dan jati diri bangsa*, Pustaka Pelajar.
- Zaini, M. F., et al. (2021). "House building tips (HBT) corpus dataset as a resource to discover Malay architectural ingenuity and identity1." *Data in Brief* 36: 107013.
- House Building Tips is the title of a classic text containing historical information on early house construction in Malay communities. These tips were written by a scholar with knowledge of house construction through observation of the surrounding environment. In Malaysia, written sources or records of house construction are scarce and underexposed. As such, this research was conducted to guarantee the written legacy of the construction of Malay houses. The purpose of this paper is to introduce a statistical data source of house building tips that is laden with Malay ingenuity and identity. The wordlists generated from this study can become a source of reference for the field of Malay architecture. Accordingly, this study utilises the quantitative method by applying the Linguistic Corpus Statistical Approach; these data utilise specific corpus development procedures, beginning with text collection, scanning and cleaning processes, text annotation, and data storing in plain text. Next, the data analysis procedure utilises a corpus software, LancsBox, to generate specialised wordlists. The bubble graphs are developed based on these wordlists through the Tableau software, and illustrate the most used lexical items with the raw and relative frequency values. This facilitates searches for, and the reading of, architectural words and architectural word references. These data represent written sources that need to be preserved and become points of reference concerning Malay architectural ingenuity and identity.
- Zed, M. (2016). "Hubungan Indonesia-Malaysia: Perspektif Budaya Dan Keserumpunan Melayu Nusantara." *TINGKAP* 11(2): 140-159.

KELANTAN

Hacking Academic English Writing Course using Innovative Pedagogy

Nur Hafezah Hussein
Universiti Malaysia Kelantan
nhafezah@umk.edu.my

ABSTRACT

The integration of technological tools into teaching and learning English writing has received great popularity in the field of higher education. The aim of this paper is to hack the academic English writing process by integrating Web 2.0 tools into the teaching and learning of an Academic English Writing course. The innovative pedagogy will not only encourage online participation and collaboration among learners, but it will also improve the writing process where the technological tools are integrated. Among various Web 2.0 tools available for teaching and learning, Coggle, YouTube, Google Docs and Google Meet have been incorporated into the teaching and learning of Academic English Writing course. 21 students were involved in this study. Data was collected via an online questionnaire and an interview. The findings suggest that the use of the web 2.0 tools is not only changing the writing process but also encourages online collaborative activity and peer feedback among students and instructors in English writing. It also enhances active communication and promotes learner-empowered learning. In future, this innovative teaching technique could also be employed for other subjects and assists instructors in dealing with the challenges and difficulties of online academic writing.

Keywords: *innovative teaching, Writing, Web 2.0 tools, collaborative, feedback, university students*

INTRODUCTION

With the shift of educational landscape from traditional classroom to blended learning, and with the recent pandemic which caused all teaching and learning to be conducted fully online, means that educators need to design interesting activity for their students, especially in teaching Academic English writing. Students often complain that they are facing problem with writing in English. The students' difficulties in writing commonly raises in developing and organizing ideas, difficulty with writing tasks and sometimes students don't know how to write in the right order and students are getting bored with the writing process. The problems also come from the lecture or teacher in using the uninteresting technique or the conventional technique to teaching writing (Ingram and Hathorn, 2009).

The online learning and teaching platform should be incorporated in the pedagogy as this platform encourages communication, participation and collaboration in language learning and help learners to participate in a more meaningful learning activity. Collaborative learning can be explained as a form of learning activity that is performed in group works for the aims of accomplishing an intended educational objective (Guerrero, Mejías, Collazosi, Pino, & Ochoa, 2003). Collaborative learning boosts higher achievement than individual performance and genuine collaboration accomplishes a given task with collective endeavour (Mindel & Verma, 2006). This also leads to a new form of social interaction between learners in which it encourages peer feedback which is crucial in learning English writing.

Given these scenarios, three popular online tools; Coggle, Google Docs and Google Meet are integrated as the innovation tools to write collaboratively and promote peer feedback in Academic English writing course. This innovation is known in short as C.G.G. C.G.G are

the initials taken from each of the e-tool used in teaching Academic English writing. C stands for Coggle, G stands for Google Docs and another G stands for Google Meet. Coggle is an online tool for creating and sharing mind maps. This tool is aimed at helping individuals take notes, brainstorm ideas, visualize connections across concepts, and collaborate with others. Coggle provides a collaborative workspace where users can share ideas, solve problems, and communicate complex information. Uses range from education to business to personal creativity. Google Docs has shown the potential as an effective online collaborative writing platform for learning English. Google Docs is a web-based free word processor, and the instructor decides to utilize Google Docs as a tool for creating students' writings, peer-editing and submitting. Using Google Doc, students can create online documents and edit them online while they are collaborating with other students or the instructor in real-time. Google Meet is a website and an app for iOS and Android meant to be a lightweight video chat service. It offers a quick, easy way to connect with other people via live video. It can also be used to do instruction, to hold group discussions, and just to help students connect with each other.

Using ADDIE model, the instructor has decided to utilize these three online tools as the new tools and alternative for collaborative writing and feedback. Lesson plans and activities were developed and designed in a way that these e-tools can be utilized. These e-tools were implemented in Academic Reading and Writing course at Universiti Malaysia Kelantan. This course is a compulsory subject at the university. In this course, group writing assignment is designed as one of the assessments for the students. For the Group Writing Assignment, students will have to work in a team of 3 or 4, and they have to write collaboratively, a first draft short research paper, and final draft short research paper.

THE WRITING PROCESS

The instructor uses all e-tools to monitor students' progress throughout the entire writing process. Before the assignment is delegated to students, a few weeks were given for instructors to give lecture on the ways of writing a short research paper. The lectures were conducted using Google Meet. Later, the assignment instruction was also delivered via Google Meet where students and instructor can discuss on the task given.

The students will be working collaboratively with their own team in completing the first draft. The students will prepare an outline prior to writing their first draft. This is where Coggle is being used as their outline. The students brainstorm ideas, and search for relevant online articles to support their main ideas for the first draft, and all these will be shared on Coggle. After the outline is completed, they will develop their ideas into writing on Google Docs collaboratively. Each student in their own team will write their own parts for the short research paper.

After they finish with the first draft, the instructor will give feedback via commenting on their Google Docs and feedback via Google Meet. The team members are encouraged to comment and give feedback on their friend's part in the first draft of writing. After the feedback, the students in their team will revise the first draft and complete the final draft on Google Docs. The final draft is then submitted via Google Docs. The overall process can be seen as in Figure 1 below:

Figure 20. The C.G.G Writing process

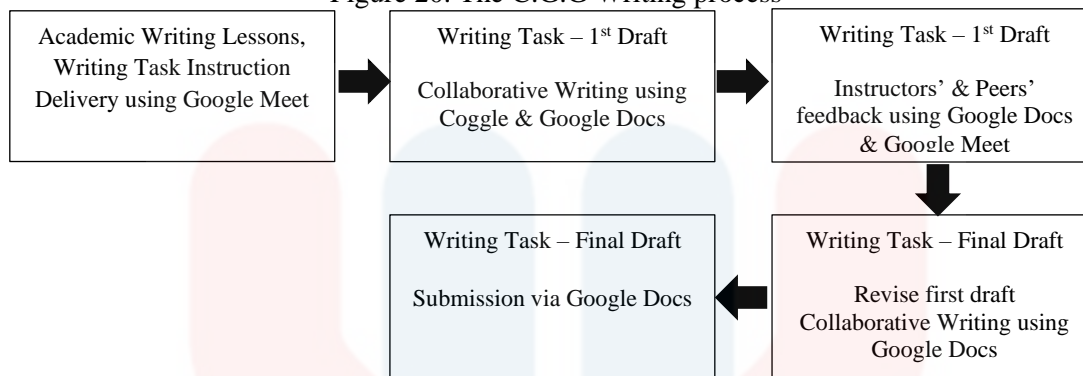

METHOD

Questionnaire was administered and interview was conducted to the students taking Academic English Writing course to find out their attitudes toward the use of C.G.G. in the collaborative writing and feedback activities. The survey data was analyzed using SPSS and the interview data was analyzed qualitatively using narrative method.

Table 21. Means and standard deviation of students' attitudes toward the use of integrated e-tools for collaborative academic writing and feedback

Statement	Mean	Std. Dev
1. I enjoy doing the essay writing task collaboratively by using Coggle and Google Docs.	4.09	1.269
2. Writing collaboratively by using Coggle and Google Docs is easier than writing individually	3.59	.796
3. Coggle and Google Docs are useful tools in collaborative writing activity	4.27	.883
4. The use of Google Meet and Google Docs in giving feedback help improve my writing	3.86	1.037
5. Collaborative writing and feedback using Coggle, Google Docs, and Google Meet improves my confidence in writing academic essay.	3.91	1.065
6. Collaborative writing and feedback using Coggle, Google Docs, and Google Meet encourage exchange of knowledge, information, and experience.	4.00	1.155
7. Collaborative writing activity and feedback by using Coggle, Google Docs, and Google Meet enhance my Academic English writing performance.	3.86	1.037
8. The use of Coggle and Google Docs in collaborative writing activity give me an opportunity to share ideas easily in my group.	4.23	1.020
9. Collaborative writing activity and feedback by using Coggle, Google Docs and Google Meet help me receive helpful feedback	3.91	1.109
10. Using Coggle and Google Docs in collaborative writing activity stimulate my critical thinking.	3.55	.800
Average	3.90	.990

Table 1 indicates that the overall mean score reflected the students' positive attitudes towards the use of Coggle, Google Docs and Google Meet in their collaborative Academic English writing and feedback (mean = 3.90). The highest score of the students' attitudes was

in statement 3 that Coggle and Google Docs are useful tools in collaborative writing activity (mean = 4.27). The students also expressed their positive attitudes towards statement no. 8 that the use of Coggle, Google Docs in collaborative writing activity offers them an opportunity to exchange ideas easily in their group (mean=4.23). The lowest mean score was on statement no.10 that collaborative writing activity using Coggle, and Google Docs stimulate their critical thinking (mean=3.55).

Furthermore, the students were also interviewed to get more insights into the efficacy of the integrated e-tools in their learning. The students expressed their wishes that this method could also be used in next or the other course. However, they also faced problems during this activity, such as inactive member in their group collaboration, confusion in using Google Docs at the beginning of the activity, and the poor of internet connection.

CONCLUSION

Overall, these e-tools have given students the autonomy in their learning. They are able to collaborate with their peers to search information related to task given by their instructors, discuss and revise their work on their own with little intervention from the language instructors. In addition, the students can access their works anywhere, anytime and have complete control of their learning. Teachers or instructors on the other hand can use these e-tools in other classes or subjects. They will also be able to assess students' understanding in their learning without spoon-feeding the students. Teachers or instructors will play an active role as facilitators to facilitate students' learning. Not only that, the integration of various e-tools in learning is the effort to a more sophisticated e-learning setting which offers meaningful and authentic learning activities.

REFERENCES

- Guerrero, L., Mejías, B. Collazosi, C. A., Pino, J. A., & Ochoa, S. F. (2003). Collaborative learning in creative writing. *Proceedings of the First Latin American Web Congress (LA-WEB 2003)*, 180-186.
- Ingram, A. L., & Hathorn, L. G. (2004). Methods for analyzing collaboration in online communications. In T.S. Roberts (Ed.), *Online collaborative learning: Theory and practice* (pp. 215-241). Hershey, PA: Information Science Publishing
- Mindel, J. L., & Verma, S. (2006). Wikis for teaching and learning. *Communications of AIS*,18(1), 2-38.

MALAYSIA

KELANTAN

The Performance of Waqf Institutions via Maqasid Syariah Index (MSI)

Nik Noorhazila Nik Mud
Universiti Malaysia Kelantan
noorhazila.nm@umk.edu.my

Wan Hakimah Wan Ibrahim
Universiti Sultan Zainal Abidin
wanhakimah@unisza.edu.my

ABSTRACT

One potential instrument to encourage the social and economic growth of the society is the waqf. Waqf has made significant contributions, although their potential and advantages have not yet been completely realised. Recognizing this problem, it is necessary for the institutions in charge of managing waqf assets to improve how well they fulfil their obligations to pertinent stakeholders, in line with the maqasid waqf perspective. This study aims to measure the performance of Waqf institutions based on the Maqasid Syariah Index (MSI). The method used in this study is a descriptive research. The study used thirteen samples of State Waqf Institutions (SWI) in Malaysia. The study data was used the annual report in 2016-2020. The analytical method used in this study was the Maqasid Sharia Index with five indicators, namely Faith/Religion (din), Intellect Advancement (aql), Life (nafs), Progeny (nasl) and Welfare (mal). The significance of this study is that it proposes the objectives of waqf institutions from the Maqasid Syariah perspective. It also suggests methodologies that can be used to develop waqf institutions performance measures based on the Syariah framework. The results of the study have shown variations in the performance of the waqf institutions.

Keywords: *Maqashid Syariah Index; Waqf Institutions; Performance Measurement.*

INTRODUCTION

Economic development is one of the important aspects of Islam. Waqf is part of the economic institutions of Muslims which is no less important. It needs to be developed and managed in the best way, so that it can be used by all Muslims especially and humans in general

Therefore, this study aims to identify the ideal objectives of waqf institutions from the theory of *Maqasid Syariah*, to propose an idea of developing a model of waqf institutions performance measures based on the objectives identified in the first research objective and to test the waqf institutions performance measures developed in second research objective on a sample of thirteen waqf institutions.

The remainder of this paper is organized as follows. The second section discusses the literature review on waqf, *maqasid waqf* and performance measurement. The third section explains the research methodology employed in this study. Research findings are reviewed and discussed in section four, and the final section highlights the conclusion and recommendations for future research.

LITERATURE REVIEW

Waqf Concept

The word waqf is derived from the root word waqafa (waqafa-yaqifu-waqfan) which means to hold back or prevent something. According to the language, waqf comes from the Arabic word waqafa which means to stop or al-habsia that is to hold only or al-man'. The term waqf also refers to the matter of "detention" of valuable property to benefit it (Ibn Manzur, 1990). Whereas, according to Sharia, waqf means holding or controlling valuable property because Allah S.W.T. only where the benefits are taken for the common good (Wahbah al-Zuhayli, 1997).

Waqf is a form of charity whose reward will continue until the end of the waqf or is destroyed, even if the waqf has died. Waqf is also a wasilah for the waqf to bring himself closer to Allah S.W.T because in it there is an element of taqarrub in addition to obtaining an unending reward (Siti Mashitoh Mahamood, 2007a). The law of endowment of property is circumcision because it is a good deed of good deeds that is highly demanded.

According to jurists, the endowment (waqif) makes the benefit of its property for charitable purposes. The property will continue to remain the property of the waqf. Therefore, waqf does not remove the ownership rights of the waqf over the waqf property, but the waqf cannot use the waqf property other than for the purpose for which it was waqf (Ibn Rushd, 2003; Wahbah Zuhayli, 1996; Mustafa al-Khin et.al. 2009). Waqf plays an important role in meeting some of the shortages in society, in addition to catalyzing economic, scientific, social and religious development, to guarantee the continuity of the teachings of Islam (Mochammad Arif Budiman, et.al., 2011).

Maqasid Syariah In Waqf Management

The objective or *Maqasid* of Islamic Law is to protect the interests and needs of people in this world and the hereafter. The meaning of *Maqasid Syariah* is the secrets that have been set by Allah S.W.T. on every law that has been stipulated, that is to achieve happiness in individuals and society as well as preserve the law and further to prosper the world until it reaches a high level of perfection, goodness, progress and civilization. According to al-Shatibi in his book *al-Muwafaqat Fi Usul al-Shariah*, in addition to preserving the benefits or interests of humans in living life in the world, it also aims to preserve the interests of humans after their death (Al-Syatibi, 1996).

Maqasid Syariah is generally divided into three parts (Al-Syatibi, 1996). First, *dharuriyyat* (essential). They are things that are included in the basic needs that must be met by every individual. Second, *hajiyyat* is a benefit that is a human need and desire. It is to remove difficulties and narrowness that can lead to hardships in life. The third part is *tahsiniyyat* that is the lowest hierarchy in the arrangement of maqasid sharia. It refers to the comfort that will be enjoyed by humans who want it. Despite the importance of *dharuriyyat*, *hajiyyat*, and *tahsiniyyat*, scholars continue to refer to the afore mentioned five requirements as a necessary element of fulfillment. Waqf, for instance, is thought to be more focused on protecting property and religion. However, some nations have very poor waqf management. Hence, advocating the creation of a *maqasid* for waqf management (Md. Ibrahim AA, Khan SH, 2015). It is in line with the suggestions made by numerous experts who advocate for improved waqf management as a means of maintaining the overall *maqasid* (Al-Mubarak T, 2017 & Habib Ahmed, 2004).

Meanwhile, *Maqasid Syariah Index (MSI)* is a concept that was recently created as a measurement device for the financial performance of Islamic financial organizations. This idea came about because the currently available and widely accepted measurement instruments

could not adequately depict the general state of a *Syariah* financial institution's achievement of *Falah* and *Maqasid Syariah*.

Performance Measurement of Waqf Institutions

The main purpose of waqf is to fulfill non-profit purposes, which is similar to non-profit organizations (Ramli & Muhamed, 2013). Therefore, the definition and measurement of performance for non-profit organizations were applied to measure the performance of waqf institutions. In a related view, Ihsan and Ayedh (2015) suggested that waqf institutions have similar characteristics to non-profit organizations and can be considered in the same category, as the formation of these organizations is to benefit society. Berman (2015) defined performance as “the effective and efficient use of resources to achieve results and objectives”.

There has been an argument on the measurement that relates to the performance of non-profit organizations (Epstein & McFarlan, 2011), particularly for waqf institutions. This is due to the complexity of the measurement as these organizations focus on and emphasize achieving their missions in which the accomplishments are difficult to measure. Fishel (2003) posited that the measurement has to consider the formation of the organization enables to achieve social, cultural, welfare or religious objectives. In general, the performance measurement of any organization in the social sector should be driven by its mission and goals (Ebrahim & Rangan, 2014). Based on the argument, it can be said that performance measurement is very close and directly related to the objectives of an organization. The formulation of performance measurement for waqf institutions needs to be guided by the objectives or *maqasid* of waqf.

SAMPLING

This study considers a sample of the following thirteen waqf institutions. Table 3 below shows the selection of 13 states of waqf institutions in Malaysia.

State	Waqf institutions	Structure
Wilayah Persekutuan	Pusat Wakaf MAIWP Sdn. Bhd (PWMSB)	Corporation
Selangor	Perbadanan Wakaf Selangor (PWS)	Corporation
Negeri Sembilan	Perbadanan Baitulmal Negeri Sembilan (PBMALNS)	Corporation
Melaka	Bahagian Pembangunan Hartanah MAIM	Department
Johor	Waqaf An-Nur Corporation Berhad (WANCorp)	Corporation
Perak	Wakaf Perak Ar-Ridzuan (WPAR)	Corporation
Kedah	Bahagian Wakaf MAINk	Department
Pulau Pinang	Wakaf Pulau Pinang Sdn Bhd (WPP)	Corporation
Perlis	Bahagian Pembangunan Wakaf, Hartanah and Mal MAIPs	Department
Kelantan	Unit Wakaf MAIK	Department
Terengganu	Seksyen Wakaf MAIDAM	Department
Pahang	Unit Wakaf MUIP	Department
Sarawak	Tabung Baitulmal Sarawak (TBS)	Corporation

STUDY DESIGN

In this study, descriptive quantitative research is used to assess the performance of state waqf institutions in Malaysia by using the Maqasid Syariah Index (MSI) ratios. The percentage value of each ratio in the *Maqasid Syariah Index* is known from the annual financial statements of sample waqf institutions for the 2016-2020 period. This study method is designed following Mohammed et al. (2008) with some adjustments and contextualization to the nature of the waqf institution. The concepts (C) into the observable characteristic of *Maqasid Syariah*, which are termed as dimensions (D). The dimensions are further broken down into measurable behaviors, referred to as elements (E) and then broken down into measurable performance that, referred to as ratio indicator (R). The five (5) broad of *Maqasid Syariah*, namely Faith /Religion (*Din*), Intellect Advancement (*Aql*), Life (*Nafs*), Progeny (*Nasl*) and Welfare (*Mal*), are operationally defined. Each of these objectives or concepts (C) is then translated into broad characteristics or dimensions (D) and measurable behaviors or elements (E) and finally as ratio indicator (R) as follows in Table 1 below:

Table 1. The *Waqf* indicator from the perspective of *Maqasid Shariah*

Objective/ <i>Maqasid shariah</i> (C)	Dimension (D)	Element (E)	Performance Ratio (R)	Sources of data
O1: Faith / Religion (<i>din</i>)	D1: Philosophy and Values	E1: Vision and Mission Statement Disclosure	R1: -Operating within Shari'ah principles/ideals -Providing returns within Shari'ah principles -Serving the needs of Muslim community -Commitments to engage only in permissible activities -Appreciation to stakeholders and beneficiaries	Annual report
	D2 : Affordable and Halal	E2 : Functional Distribution Product and Services	R2 : -No involvement in non-permissible activities -Basis of Shari'ah concept in approving product and services -Total revenue Commitments	Annual report
O2: Intellect Advancement (<i>aql</i>)	D3 : Advancement of knowledge	E3 : Education grant	R3: -Education grant or scholarship/total expenses	Annual report
		E4: Research	R4: -research expense / total expense	
	D4: Developing new skills and improvement	E5: Training	R5: -Training expense / total expense	

	D5: Awareness	E6 : Publicity	R6: -Publicity expense/total expenses -Channel of publicity and marketing	
O3 : Life (<i>nafs</i>)	D6: Security & Health	E7: Safety	R7: -Security expenses -Health cost	Annual report
	D7: Freedom & Justice	E8: Fairness	R8: -Equality of opportunity -Fairness in distribution	
	D8: Investment in real economic sector	E9: Investment ratios in real economic	R9: -Investment in real economic sector / Total Investment	
O4 : Progeny (<i>nasl</i>)	D9 : Social Indicators	E10: Policy Objectives and environmental issues	R10: -Mission statement/statement of social policy -Consumer care -Community involvement	Annual report
	D10: Development and Social	E11: <i>Waqf</i>	R11: -Types, Beneficiaries, Sources and amount of <i>Waqf</i>	
	D11: Development and welfare of employees	E12: Employees	R12: -Number of employees -Employees welfare	
O5: Welfare (<i>mal</i>)	D12: Corporate Governance Indicator	E13: Accountability Transparency Fairness Responsibility	R13: -Statement on Corporate Governance -R14: -Board meetings were conducted at least four times a year	Annual report

Source: Adapted from Noor et al. (2018)

Verification of the performance Measures

The *Maqasid Syariah Index* for an individual waqf is the sum of its performance indicators to fulfill the five objectives of *maqasid shariah*.

Table 2. Assigned weights in IMS based on the concept of balance

The objective of Maqasid al-Shari'ah	Average weight (Out of 100%)	Elements	Average weight (Out of 100%)
O1: Faith / Religion (<i>din</i>)	0.20	E1: Vision and Mission Statement Disclosure	0.50
		E2: Functional Distribution Product & Services	0.50

		Total	100%
O2: Intellect Advancement (<i>aql</i>)	0.20	E3: Education grant	0.25
		E4: Research	0.25
		E5: Training	0.25
		E6: Publicity	0.25
		Total	100%
O3: Life (<i>nafs</i>)	0.20	E7: Safety	0.33
		E8: Fairness	0.33
		E9: Investment ratios in real economic	0.33
		Total	100%
O4: Progeny (<i>nasl</i>)	0.20	E10: Policy objective and environmental issues	0.33
		E11: Zakat, Waqf charity and benovelent loans	0.33
		E12: Employee	0.33
		Total	100%
O5: Wealth (<i>mal</i>)	0.20	E13: Accountability, Transparency, Fairness and Responsibility	1
Total	100%	Total	100%

Source: Adapted from Hudaefi & Noordin (2019) and Mohammed et al., (2008)

As Hudaefi & Noordin (2019) proposed, the evaluation of the individual waqf objectives can be realized as the equation below.

First, Objective 1 is obtained by O1:

$$O1 = W_1^1(E_1^1 \times R_1^1 + E_1^2 \times R_1^2)$$

denotes:

O1 = the first of the *Maqasid Syariah*, which is faith (*dīn*);

W_1^1 = the weight assigned to (O1) (see Table 2);

E_1^1 = the weight assigned to the first element of (O1) (see Table 2);

E_1^2 = the weight assigned to the second element of (O1) (see Table 2);

R_1^1 = the evaluation for the performance ratio corresponding to E_1^1 of (O1) (as applied in Table 1); and

R_1^2 = the evaluation for the performance ratio corresponding to E_1^2 of (O1) (as applied in Table 1).

Second, Objective 2 is obtained by O2:

$$O2 = W_2^2(E_2^3 \times R_2^3 + E_2^4 \times R_2^4 + E_2^5 \times R_2^5 + E_2^6 \times R_2^6)$$

denotes :

O2 = the second of the *Maqasid Syariah*, which is intellect advancement (*aql*):

W_2^2 = the weight assigned to (O2) (Table 2);

E_2^3 = the weight assigned to the first element of (O2) (Table 2);

E_2^4 = the weight assigned to the second element of (O2) (Table 2);

E_2^5 = the weight assigned to the third element of (O2) (Table 2);

E_2^6 = the weight assigned to the fourth element of (O2) (Table 2);

R_2^3 = the evaluation for the performance ratio corresponding to E_2^3 of (O2) (as applied in Table 1);

R_2^4 = the evaluation for the performance ratio corresponding to E_2^4 of (O2) (as applied in Table 1);

- R_2^5 = the evaluation for the performance ratio corresponding to E_2^5 of (O2) (as applied in Table 1); and
 R_2^6 = the evaluation for the performance ratio corresponding to E_2^6 of (O2) (as applied in Table 1).

Third, Objective 3 is obtained by O3:

$$O3 = W_3^3(E_3^7 \times R_3^7 + E_3^8 \times R_3^8 + E_3^9 \times R_3^9)$$

O3 = the third of the *Maqasid Syariah*, which is life (*nafs*),

W_3^3 = the weight assigned to (O3) (Table 2);

E_3^7 = the weight assigned to the first element of (O3) (Table 2);

E_3^8 = the weight assigned to the second element of (O3) (Table 2);

E_3^9 = the weight assigned to the third element of (O3) (Table 2);

R_3^7 = the evaluation for the performance ratio corresponding to E_3^7 of (O3) (as applied in Table 1);

R_3^8 = the evaluation for the performance ratio corresponding to E_3^8 of (O3) (as applied in Table 1) and;

R_3^9 = the evaluation for the performance ratio corresponding to E_3^9 of (O3) (as applied in Table 1)

Fourth, Objective 4 is obtained by O4:

$$O4 = W_4^4(E_4^{10} \times R_4^{10} + E_4^{11} \times R_4^{11} + E_4^{12} \times R_4^{12})$$

denotes ;

O4 = the fourth of the *Maqasid Syariah*, which is progeny (*nasl*);

w_4^4 = the weight assigned to (O4) (Table 2);

E_4^{10} = the weight assigned to the first element of (O4) (Table 2);

E_4^{11} = the weight assigned to the second element of (O4) (Table 2);

E_4^{12} = the weight assigned to the third element of (O4) (Table 2);

R_4^{10} = the evaluation for the performance ratio corresponding to E_4^{10} of (O4) (as applied in Table 1);

R_4^{11} = the evaluation for the performance ratio corresponding to E_4^{11} of (O4) (as applied in Table 1); and

R_4^{12} = the evaluation for the performance ratio corresponding to E_4^{12} of (O4) (as applied in Table 1).

Fifth, Objective 5 is obtained by O5:

$$O5 = W_5^5(E_5^{13} \times R_5^{13})$$

denotes ;

O5 = the fifth of the *Maqasid Syariah*, which is wealth (*mal*);

w_5^5 = the weight assigned to (O5) (Table 2);

E_5^{13} = the weight assigned to the first element of (O5) (Table 2);

R_5^{13} = the evaluation for the performance ratio corresponding to E_5^{13} of (O5) (as applied in Table 1).

Hence, overall Integrated *Maqasid Syariah Index* (MSI)

$$MSI = O1 + O2 + O3 + O4 + O5$$

EMPIRICAL RESULTS

Performance Ratios

Table 3. Performance Ratios for five Syariah Objectives in thirteen State Waqf Institutions from 2016-2020

State	<i>Maqasid Syariah Index (MSI) (%)</i>				
	2016	2017	2018	2019	2020
Wilayah Persekutuan	84.76	86.63	83.1	83	87.9
Selangor	83.5	85.5	87.6	86.5	88.5
Negeri Sembilan	84.5	86.5	85.5	87.6	87.5
Melaka	87.75	89.55	86.35	87.9	87.3
Johor	85.4	87.5	86.4	87.5	89.8
Perak	83	88.7	86.5	89.6	88
Kedah	84	86.5	87.6	88	87.9
Pulau Pinang	86.5	88.6	87.9	89.7	86.5
Perlis	81	83.2	84.5	85	83.5
Kelantan	86.5	86.5	88.6	89.5	88.6
Terengganu	85	85.6	86.8	88	89.5
Pahang	84	85	85.6	86	86.5
Sarawak	82	83.5	86.5	85.5	86

Based on table 3, all *MSI* percentage values in thirteen state institution waqfs experienced ups and downs from 2016-2020. The percentage of *Maqasid Syariah Index* in waqf institutions in five years exceeded 80 percent and above. This proves that there is still space that needs to be improved in the waqf management system so that the waqf institutions in Malaysia are always centered on the sharia foundation in drawing success in improving the quality of life and universal prosperity.

CONCLUSION

The performance assessment of waqf institutions using the *Maqasid Syariah Index (MSI)* concept shows that the achievement of waqf institutions performance is quite good. The greatest significance of this study is that it proposes the objectives of waqf institutions from the *Maqasid Syariah* perspective. It also suggests methodologies that can be used to develop waqf institutions performance measures based on the *Syariah* framework. The results of the study have shown variations in the performance of the waqf institutions. As this is an exploratory study, hopefully, future research will consider it a starting point for further developing objectives and performance measures of waqf institutions based on the *syariah* framework.

REFERENCES

- Al-Zuhayli, Wahbah. (1997). *Nazariyah al-Dharurah al-Syari'yyah Muqaranah ma'a al-Qanun al-Wadhi'*. Damsyiq: Dar al-Fikr.
- Al-Mubarak T (2017). The *Maqasid* of Zakah and Awqaf and Their Roles in Inclusive Finance. *Islam Civilisational Renewal ICR*; 7, <http://www.icrjournal.org/icr/index.php/icr/article/view/548> (2016, accessed 20 January 2017).
- Ebrahim, A., & Rangan, V. K. (2014). What impact? A framework for measuring the scale and scope of social performance. *California management review*, 56(3), 118-141.

- Epstein, M. J., & McFarlan, F. W. (2011). Measuring the efficiency and effectiveness of a nonprofit's performance. *Strategic finance*, 93(4), 27.
- Habib Ahmed (2004). *Role of Zakah and Awqaf in Poverty Alleviation*. First edition. Jeddah, Kingdom of Saudi Arabia: Islamic Development Bank (IDB) and Islamic Research & Training Institute (IRTI).
- Hudaefi, F. A., & Noordin, K. (2019). Harmonizing and constructing an integrated maqāsid al-Sharī'ah index for measuring the performance of Islamic banks. *ISRA International Journal of Islamic Finance*, 11(2), 282–302. <https://doi.org/10.1108/IJIF-01-2018-0003>
- Ihsan, H., & Ayedh, A. (2015). A proposed framework of Islamic governance for awqaf. *Journal of Islamic economics, banking and finance*, 11(2), 117-133.
- Mahamood, S. M. (2007). The formation of waqf funds according to the perspective of sharia and law and its application in Malaysia. *Journal of Sharia*, 15(2), 61-83.
- Mohammed, M. O., Razak, D. A., & Taib, F. M. (2008). The Performance of Islamic Banking Based on The Maqashid Frammework. Makalah Disampaikan Pada IIUM International Accounting Conference (INTAC IV). Putra Jaya Marroit. Malaysia. 25 Juni 2015., 4(2), 85–101.
- Mohamad Akram Laldin, et al (2006). "Maqasid Syariah In Waqf Implementation", Convention paper Waqf 2006, in Kuala Lumpur, 12-14 September 2006.
- Md. Ibrahim AA, Khan SH (2015). Waqf management in Bangladesh: An analysis from Maqasid al-Shar'ah perspective. IAIS Malaysia, Kuala Lumpur: International Institute of Advanced Islamic Studies (IAIS) Malaysia, http://www.iais.org.my/e/attach/2015/maqasid2015/pdf/s3s3_paper.pdf (2015).
- Mohammed, M. O. (2014). Developing UM-HI Theoretical Framework. International Thematic Workshop on Developing a Maqaasid Al-Shari'ah based Measurement of Socio-economic Development (pp. 240-250). Yogyakarta: Islamic Research and Training Institute, IDB & Universtas Sains Islam.
- Noor, A. H. M., Sani, A. A., Hasan, Z. A., & Misbahrudin, N. T. (2018). A Conceptual Framework for Waqf-Based Social Business from the Perspective of Maqasid Al-Shariah. *International Journal of Academic Research in Business and Social Sciences*, 8(8), 801–818. <https://doi.org/10.6007/ijarbss/v8-i8/4635>
- Ramli, N. M., & Muhamed, N. A. (2013). Good governance framework for corporate Waqf: towards accountability enhancement. In *Paper accepted for Proceedings Of World Universities' Islamic Philanthropy Conference*.

Developing Education Leaders in Managing Adaptation of Technology: Focus Group Analysis

Muaza Shifa Rumeli

Faculty of Educational Studies, Universiti Putra Malaysia
gs59054@student.upm.edu.my

Ahmad Aizuddin Md Rami

Faculty of Educational Studies, Universiti Putra Malaysia
ahmadaizuddin@upm.edu.my

ABSTRACT

The Industrial Revolution (IR) is an event that marks significant progress in human civilisation. In view of the IR 4.0 which has reached its peak, urged all parties to act fast. For formal education to compete globally, educational organizations such as schools need to efficiently bring their workforce to act and pursue the progress. This study aims to explore how education leaders in Malaysia manage the adaptation of technology. The qualitative approach was utilized in the form of a focus group discussion with various stakeholder. The findings demonstrate that the primary themes are technology integration through leadership and vision; technology management through professional practice; and technology integration for teaching and assessment; all of which are important to be considered by school leaders to adapt to new technology. The analysis presented in this study can be used as a reference by the concerned parties to help to strengthen educators in Malaysia.

Keywords: *Andragogy; Challenges; education technology; education leaders; leadership.*

INTRODUCTION

Industrial Revolution 4.0 has strengthened management, industrial and commercial structures that emphasize on digital technology development in reducing human energy costs while increasing productivity. The increasingly robust development of digital systems has prompted various industry sectors around the world to develop high-tech robotic machines (Adlina et al., 2020). Digital technology systems also facilitate large-scale data usage globally that enable fast and effective long-term cost saving works. Therefore, the importance of digital education in the current Industrial Revolution 4.0 has been among the topics of discussion in various sectors especially for the educational sector. National education system is also facing new changes namely: the 21st century teaching and learning and the Industrial Revolution 4.0. The 21st century is often linked with the era of information technology (IT), while the Industrial Revolution 4.0 refers more to the development of robotic technology (Lu, 2017). The development of 'open sky technology' certainly has implications for human life (Mohamad, 2003). Undeniably, education is the most important tool in the development of human resources that will serve to develop the country. Various efforts were made for the purpose to boost the national education system. However, there are education leaders who still do not understand the importance of digital education elements and do not realise the existence of Industrial Revolution 4.0 in the academic context and daily lives. This article will explore the level of understanding of education leaders and their perception towards Industrial Revolution 4.0. This is also part of the effort to support the Malaysian Education Blueprint (2013-2025) as outlined by the Ministry of Education Malaysia in utilizing ICT to improve the teaching and learning quality in Malaysia.

LITERATURE REVIEW

Development of Education Leaders

Leaders play an important role in constituting the effectiveness of a system in an institution (Ibrahim et al., 2018). Abdullah and Ismail (2018) also stated that the strength and quality of leadership lies in the leader's ability to achieve and realize the vision and mission adopted in his leadership institution. Therefore, leaders need to manage their professional development effectively. According to Yusof and Tahir (2018), the development of leaders should be accepted as a necessity and discipline to improve the quality of the organization and as a return, would benefit the parties involved such as workers and stakeholders. Abdullah et al., (2018) states that a leader must act to set the direction and future of the organization. Leaders should also focus and look forward to achieve the vision and mission of an organization after considering various internal and external factors. Bennis (1989) also stated that the quality a good leader needs most, is his vision to guide and provide a clear idea of the requirements and direction of the organization.

Mohamad et al. (2016) stated that educational leadership involves all activities, behaviour, skills, attitudes, and knowledge that reflect the ability and willingness to influence, drive, guide and train individuals, school staff and community outside the school towards achieving the objectives of the school organization. Leithwood et al. (2012) says that in the 21st century i.e., in the era of industrial revolution 4.0, there are two major changes that a leader must face. First, improving accountability, improving student performance and school attainment are the focus of the community and it is the responsibility of the school leaders to fulfil them. Second, the extent to which education leaders are responsible for taking direct steps in determining a goal in line with the Ministry of Education's policy. The 21st century leadership means that one must act proactively using technological knowledge to generate vision and act as an agent of change (Duclewicz & Higgs, 2003). Hence the Industrial Revolution which took place in the 21st century led to the development of education leaders through their proactive behaviour based on the knowledge in achieving goals and improving the teaching and learning processes in schools (Ismail, 2019).

Leadership in the Industrial Revolution Era 4.0

To promote the Industrial Revolution 4.0 in the world of education, three main elements are targeted in supporting the Industrial Revolution implementation among education leaders. First is to add knowledge and skills in the field of technology (Peng et al., 2020). The second element is to provide the necessary facilities to school residents such as a smooth internet network, technological equipment such as sufficient number of computers and conducive spaces (Yusuf & Tahir, 2018). While the third element is to cultivate innovation and technology with school residents (Noorashid, 2019). Looking at the first element which is to find room and opportunities to increase knowledge and skills of the technology field, it is parallel as outlined by the Malaysian Education Development Plan 2013-2025 in the seventh shift i.e., in utilizing ICT to improve the quality of learning in schools. Therefore, education leaders must strive to enhance their knowledge and skills in line with digital transformation to remain competent and remain competitive. Apart from this, the Industrial Revolution 4.0 involving automation technology provides new challenges and opportunities to the education sector in the country (Noorashid, 2019).

Meanwhile, education leaders should play the role to rearrange the activities of the teaching and learning process to meet the challenges of this revolution. This change covers various aspects such as conducive learning space, systematic teaching methods, adequate facilities, and the use of the latest technology. It coincides with the second element outlined which is providing the necessary facilities to the school staffs. While for the elements of

cultivating innovation and technology, education leaders are seen to be able to play the role of individuals who have the potential to influence teachers and students to succeed in this challenge (Banoglu et al., 2016). The exposure to the Industrial Revolution 4.0 to teachers should be emphasized in line with the education transformation of the Ministry of Education Malaysia. In addition, teaching methods that are in line with the Industrial Revolution 4.0 should be practiced broadly. According to Ismail et al. (2020), education plays a very important role in the Industrial Revolution 4.0. Therefore, the approach of enabling technology-based learning and teaching should be changed in line with the development of automation as a strategy against competition to remain relevant as future jobs will also change. It is clear here that the preparation to apply industrial revolution 4.0 in the education sector especially in schools should be driven by education leaders. The culture of creativity and innovation in an educational institution especially schools are important to face the Industrial Revolution 4.0 era. Education leaders including teachers should cultivate themselves to face the challenges of technological development in the future. In navigating the industrial revolution 4.0 the focus is on the use of modern technologies such as the use of data globalization and self-driven. According to the Strategic Plan of the Ministry of Science, Technology, and Innovation (MOSTI) 2016-2020, innovation needs to be empowered in line with the Basic Science, Technology, and Innovation of The State (DSTIN) which sets a new direction in the field of science, technology, and innovation (STI) to transform Malaysia towards a more competent and competitive country, thus, be prepared to go through the flow of Industrial Revolution 4.0.

The Importance ICT

Information and communication technology or ICT has long been regarded as a driver of economic growth, whether in developed countries or in developing countries. ICT is often associated with social and political change and serves as a driver of innovation (Spence & Smith, 2009). In 2000, the Malaysian Government established the Multimedia Development Corporation (MDeC) as the leader in the development of ICT infrastructure in Malaysia. The government's efforts are in line with the global development of ICT to boost the economy and the development of human resources to meet the economic needs of the 21st century. The Malaysian government is aware that the efforts to produce k-workers must start from school. The Pilot Bestari School project is one of the major projects implemented by the Government of Malaysia to kickstart the educational transformation that harnesses innovation and development in the field of ICT. In this regard, school leaders play an important role as the leaders of innovation and change. Brodin (2010) said that school leaders have an important role in the implementation of new technologies and in developing new learning models in schools. According to Brodin (2010), if school leaders have a positive and knowledgeable view of computers and ICT, they will instill a positive attitude towards integrating ICT in the teaching and learning process among teachers. In other words, Brodin argues that school leaders should have literacy in ICT to lead the implementation of ICT in school operations.

Education Leadership and ICT

In Malaysia, ICT was introduced in the world of education in the early 1990s. From then on, the Ministry of Education Malaysia (KPM) has implemented various information and communication technology (ICT) initiatives in schools to provide physical and non-physical necessities to enable the use of ICT as a tool in the teaching and learning process as well as school management. Among the initiatives that have been implemented are the creation of computer laboratories, Pilot Project of The Smart School, Teaching and Learning Science and Mathematics in English Language (PPSMI), EDUCATION TV via satellite, Edu Web TV

which remains today, SchoolNet network, School Access Center, digital course software development and others. KPM has invested at least six billion ringgit (KPM, 2010) in the effort to develop ICT infrastructure to achieve the implementation of ICT in education. KPM also faces challenges to provide knowledgeable and skilled human resources in the ICT field. To ensure that all ICT infrastructure for education is utilized optimally, leaders must have competency in ICT management. Mohamad and Munindy (2007) are in the opinion that, the ICT knowledge and proficiency of most school leaders are at the low level. To plan intervention actions for school leaders, the competencies required are such as, training, guidance, and recognition programmes. Through these competencies, it can help to determine other training needs that should be provided for the leaders to develop human resources in schools to become more competent (UNESCAP, 2009). Therefore, Aminuddin Baki Institute was appointed as a training institution entrusted to provide trainings to education leaders to enhance management competencies and leadership in the field of ICT.

METHOD

This study uses the qualitative method to collect data. The research design chosen by the author is a literature review and a descriptive survey review using field research methods through interviews. This is consistent with the most common sources of qualitative data, including interviews, observations, and documents (Patton, 2002). In addition, semi-structured and structured interviews were conducted to obtain more in-depth input (Sargeant, 2012). Focus group discussion were conducted with five education leaders who were one MOE Senior Officer, three school Principals from Negeri Sembilan, Malaysia and one Senior Assistant Teacher (Academic). In total, they were five participants selected based on a purposeful sampling. Thematic analysis was used to analyze the data.

Table 1: Participants' demographic information

Participant	Sex	Age	Post
S1	Male	49	Principal
S2	Female	50	Principal
S3	Male	44	Principal
S4	Male	50	Senior Assistant Teacher (Academic)
S5	Male	39	MOE Senior Officer

Meanwhile, ethical issues are another essential consideration in every research planning. The respondents must not be burdened by the research or data collection. Thus, in this study, the safety and confidentiality of the respondents are protected. Nicknames are used during the writing and encoding process to protect the privacy of the respondents. Respondents are also aware that they can withdraw from this study at any time without giving any explanation

FINDINGS AND DISCUSSION

Education leaders need to be more open and prepared for future changes to ensure that teachers and students remain competent and competitive. They need to be creative to plan and design organizational management activities so that teachers and students can create potentials that meet the needs of Industrial Revolution 4.0. Therefore, we need to be physically, mentally, spiritually, and emotionally prepared. The presence of Industrial Revolution 4.0 cannot be delayed or prevented. Readiness and change should be taken as a step in addressing the challenges of Industrial Revolution 4.0. The education sector needs to be more flexible and

ready to face the challenges so that there are no marginalized teachers or students in this era of globalization and digitalization. With a more flexible and extensive online learning style, education leaders can support and encourage teachers to be more professional and knowledgeable when conducting teaching and learning activities. Teachers also need to be sensitive to the needs and interests of students so that effective teaching methods can be used to obtain targeted results. Based on the data analysis, three major themes have been identified.

Technology Integration through Leadership and Vision

The primary role of the principal has changed from a traditional manager to a curriculum and technical leader (Raman et al., 2019). In fact, the principal as a school leader must play an active role in responding to today's educational challenges. In addition, it is hoped that principals can integrate technology into the work and learning ecosystems by clearly communicating their vision to teachers and support staff, thereby providing a technology-friendly environment.

"... Through the technology network provided in schools such as internet facilities, fax machines and smart phone apps. (Telegram), it helps the school management works and help achieving our school vision and also KPM expectation. Technology can also support teachers and staff to work faster and more efficiently..."

(S1, Principal)

"....Technology actually facilitates work; my teachers are very committed to technology. Examples like now, even our meeting minutes we do not have to print anymore and we send via school telegram and teacher can access via online. Save on printing costs..."

(S3, Principal)

".... I found that leaders who use ICT in organization management will smoothen their daily activities....."

(S5, Senior Officer MOE)

Chang, et al., (2008) believe that principals play an important role in leading schools towards school reform. To support technological change, school leaders must play a more specific role as change agents, integrating technology into a wide range of administrative, academic, awareness, and training fields. In fact, in a study by Leong and Sathiamoorthy (2016), they explored the correlations between technological relationship behaviour, principal vision and teacher technology integration level which resulted in a strong correlation between the two significant variables. Therefore, the relationship between principal leadership and technology applications is positive.

Technology management through professional practice

Educational leadership has always been facing the challenge of providing future teachers with technical and technology-related skills. These changes have forced school principals to take the lead in technological changes in their professional practices.

"... Since the pandemic hit, teachers have been trying to learn a lot about technology. Among the things that I can see are like how to make live online classroom using google meet, they learn how to make video recording using various applications and they are getting more proficient using animation apps. I'm proud of my teachers..."

(S1, Principal)

“... I appointed a specialist teacher in my school to create a PLC group. It aims to help other teachers to use technology better such as online teaching and learning using telegram app. This is one of our newest activities...”

(S2, principal)

“.....junior teachers are seen to be more active in using technology in teaching and learning activities while senior teachers are seen to be less interested in using ICT in their teaching and learning activities...”

(S4, Senior Assistant Teacher)

Every educational organization deals with various subcultures and ways of perceiving organizational processes, such as the use of technology. Educational management is now implemented using technologies such as online applications, software, test data analysis, and data display. Schools, teachers, school support staff and students use online systems. The school is responsible for the management and management of the necessary steps in each technologically driven innovation process. Professional expertise and key practice, technology embeddedness in management and sustainable use of teaching depend on the style and philosophy of the principal. Arumugam and Shariff (2017) concluded that e-learning or virtual learning technology has become widespread at the level of lower and higher education in Malaysia. This is a challenge for educational leaders to continue motivating their teachers to constantly applying the use of technology in teaching and work management.

Technology integration for teaching and assessment

Successful digital transformation in the higher education classroom requires technical tools to determine the assessment of learning. Principals play an important role in implementing teacher evaluation and policy effectiveness that affect the overall school culture (Anderson & Dexter, 2005). The successful implementation of teaching through technical integration assessment depends on the ability, motivation, and ability of the principal. Recently, assessing the ability and performance of teachers has become a complex task for university presidents, especially when teaching is combined with technology. Principals must assess teachers' teaching responsibilities; they integrate technology into learning.

“... I always support my teachers, I allow them to use technology materials such as projector machines, school laptops according to school schedule during this pandemic. If their home internet line is not stable during this pandemic, they can use the internet in school. After all my teachers mostly live nearby to our school. ”

(S1, Principal)

“....I observe my teachers by joining myself into PDPR sessions (via online) and I found my teacher were good at conducting and controlling the sessions....”

(S2, Principal)

“..... Usually, young teachers are faster in using ICT in teaching and learning activities. However, there are also senior teachers who like ICT and will use ICT to smoothen their tasks.....”

(S4, Senior Assistant Teacher)

Suffice to say, principals must analyze the efficiency of technology-based instructional techniques, evaluate existing management operations based on technology for improvement, and delve deeper into the effectiveness of digital technologies for teacher performance (Richardson & McLeod, 2011).

CONCLUSION AND IMPLICATIONS

Education leaders and teachers in Malaysia should prepare themselves with the knowledge and skills in science and technology as recommended to meet the challenges of the Industrial Revolution 4.0. The willingness of education leaders to bring teachers equipped with the ICT knowledge under their leadership can make a difference to the progress of their students. This is because the effectiveness of a teacher starts with the excellency of their leader and they try various strategies in creative, proactive, and competitive manners. In summary, the education sector needs to be prepared to go through the Industrial Revolution 4.0 so that the existing teachers and students can remain competent. Widespread exposure and approach should be disseminated to all teachers to increase the level of awareness and knowledge of the Industrial Revolution 4.0. With this, educational transformation can be implemented through teaching and learning methods in facing challenges of the Industrial Revolution 4.0. Therefore, to face the Industrial Revolution 4.0 era, human development is an important platform in generating the paradigm shift in each teaching staff. It also plays an important role in producing knowledgeable and beneficial human resources for the country. According to Wan Abdullah and Mohd Zhaffar (2018), the changes that occurred in the Industrial Revolution 4.0 demands knowledgeable and highly skilled human resources. With that, they can be competitive and able to lead their organizations globally.

As a result, Industrial Revolution 4.0 can contribute to the positive development in the new millennium education model with the use of modern telecommunication tools and can assist the teaching and learning process as well as attracting the interest of digital generation students. The progress of leaders in the Industrial Revolution 4.0 is also closely related to leadership patterns in the VUCA era. VUCA is an acronym for Volatility, Uncertainty, Complexity and Ambiguity. The term appeared in the leadership theories of Warren Bennis and Burt Nanus in 1987, which was later used in military leadership exercises in the United States. The VUCA brings in four situations: Volatility, Uncertainty, Complexity and Ambiguity. All these situations give a clear picture to education leaders to be prepared with efficiency, knowledge, technological agility and probability of issues or problems in the world of leadership. Therefore, Bob Johansen adapted VUCA in his 2009 book, *Leaders Make the Future* on how to deal with these four situations for VUCA by eliminating Volatility and replacing it with vision (O.Mack et al.,2016)

To face the progress and the future of the organization, leaders must set clear visions and achievable targets. To address The Uncertainty, leaders must try to develop ways of thinking and act against all threats of uncertainty. Always observe, analyze and compete healthily in the education sector and take it as a challenge in order to not be left behind. For the Complexity, it is recommended to React to Complexity With Clarity. Focus on how to communicate. In complex situations, communicating clearly can be helpful for leaders and subordinates to understand organizational direction. VUCA situations are too complicated for individuals to handle. While Ambiguity must be overcome with Agility. Through this situation, leaders must always encourage their members to move vigorously and have the skills to cultivate cooperative practices within the organization. Overall, the VUCA era requires leaders to act quickly in developing new, future-oriented skills that based on the Industrial Revolution 4.0. Leaders also need to be trained with the skills and elements that will provide them with new leadership learning which can prepare them to face the VUCA world. Industrial Revolution 4.0 has been seen as a situation that prepare education leaders to face the agility and surge in technology.

REFERENCES

- Abdullah, A. S., & Ismail, S. N. (2018). Interaksi Kepimpinan Perkongsian dan Kepimpinan Sahih Guru Besar Terhadap Motivasi dan Tekanan Kerja Guru. *JuPiDi: Jurnal Kepimpinan Pendidikan*, 5(1), 16-32.
- Adlina A.K, Mohamad Khairi H.O dan Mohd Kasri (2020) Memacu Pendidikan di Era Revolusi Industri 4.0: Penerapan Nilai-nilai Islam dan Inovasi dalam Pengajaran di Institusi Pengajian Tinggi. *ISLĀMIYYĀT* 42(Isu Khas) 2020:1 -20 <https://doi.org/10.17576/islamiyyat-2020-42IK-02>
- Arumugam, R. & Shariff, S. (2017). Relationship Between Technology Leadership, ICT Facility, Competency, Commitments And Teachers Practices On Implementations With Effective Teacher's Management Tasks In Schools. *School ledge International Journal of Multidisciplinary & Allied Studies*, 4(9), 88–96.
- Banoglu, K., Vanderlinde, R., & Cetin, M. (2016). Investigation Of Principals' Technology Leadership Profiles In The Context Of Schools' Learning Organization Culture And ICT Infrastructure: F@Tih Project Schools Vs The Others. *Education and Science*, 41(188), 83–98. <https://doi.org/10.15390/EB.2016.6618>
- Bennis, Warren. (1989). *On Becoming a Leader*. New York: Perseus Books.
- Brodin, J. (2010). Can ICT Give Children With Disabilities Equal Opportunities In School? *Improving Schools 2010*. DOI: 10.1177/1365480209353483.
- Dulewicz, V. and Higgs, M. (2003). 'Leadership At The Top: The Need For Emotional Intelligence In Organizations', *International Journal of Organizational Analysis*, Vol. 11, No. 3, pp.193–210.
- Ibrahim, R., Hasan, M. R., & Hamid, B. A. (2018). Takrif Kepimpinan, Ciri-Ciri Pemimpin dan Motivasi untuk Memimpin menurut Sudut Pandang Pemimpin Wanita Akar Umbi. *Malim: Jurnal Pengajian Umum Asia Tenggara (Sea Journal of General Studies)*, 19, 28–42. <https://doi.org/10.17576/malim-2018-1901-03>
- Institut Aminuddin Baki (IAB). (2018). *Pembangunan pemimpin pertengahan*. Bandar Enstek, Malaysia.
- Ismail, N. A., Wahid, N. A., Yusoff, A. S. M., Wahab, N. A., Rahim, B. H. A., Majid, N. A., Din, N. M. N., Ariffin, R. M., Adnan, W. I. W., & Zakaria, A. R. (2020). The Challenges of Industrial Revolution (IR) 4.0 towards the Teacher's Self-Efficacy. *Journal of Physics: Conference Series*, 1529(4), 0–6. <https://doi.org/10.1088/1742-6596/1529/4/042062>
- Leithwood, K., & Sun, J. (2012). The Nature and Effects of Transformational School Leadership. *Educational Administration Quarterly*, 48(3), 387–423. doi:10.1177/0013161x11436268
- Lu, Y. (2017). Industry 4.0: A Survey On Technologies, Applications And Open Research Issues. *Journal of Industrial Information Integration*, 6, 1–10. <https://doi.org/10.1016/j.jii.2017.04.005>
- Mohamad, R., & Munindy, B. (2007). Menterjemahkan kepimpinan Teknologi bagi Melahirkan Kepimpinan Instruksional yang cemerlang. *Jurnal Pengurusan dan kepimpinan Pendidikan*. 17(2). 91-103.
- Mohamad, S. (2003). Memahami Isu-isu Pendidikan Islam di Malaysia. *Institut Kefahaman Islam Malaysia (IKIM)*. Kuala Lumpur.
- Mohamad Yusoff .Z.J, Don.Y, & Ismail. S.N. (2016). Pengaruh kepimpinan distributif terhadap pengurusan konflik dalam kalangan pemimpin sekolah. *Jurnal Pendidikan Malaysia*, 41(2), 165–171.
- Noorashid, N.A (2019). Industri 4.0: Persediaan Tenaga Pengajar IPT. *3 Colloquium Paper: Advanced Materials and Mechanical Engineering Research, 2000*.

- O. Mack, A. Khare, A. Kraemer, and T. Burgartz (2016) *Managing in a VUCA World*, Springer.
- Patton, Q.M (2002). *Qualitative Interviewing*. In *Qualitative Research And Evaluation Methods*. Thousand Oaks, CA : Sage Publications Inc.
- Peng, T.K., Mohamad, J., Jaafar, J., Wahab, R., Ching, H.B & Machappan, K (2020), *Kompetensi Pemimpin Pertengahan Bagi Alaf Revolusi Industri 4.0: Satu Kerangka Konseptual*, *Jurnal Pengurusan dan Kepimpinan Pendidikan*, Institute Aminuddin Baki.
- Raman, A., Thannimalai, R., & Ismail, S. N. (2019). Principals' technology leadership and its effect on teachers technology integration in 21st century classroom. *International Journal of Instruction*, 12(4), 423-442.
- Richardson, J. W. & McLeod, S. (2011). Technology leadership in Native American schools. *Journal of Research in Rural Education*, 26 (7), 1-14.
- Sargeant (2012) *Qualitative Research Part II: Participants, Analysis, and Quality Assurance*, *J Grad Med Educ* (2012) 4 (1): 1-3.
- Spence, R., & Smith, M. (2009). A dialogue on ICTs, human development, growth and poverty reduction: A background paper. The Harvard Forum. *Berkman Center for Internet & Society at Harvard University and Canada's International Development Research Centre*. http://publius.cc/dialogue_icts_human_development_growth_and_poverty_reduction/091109
- UNESCAP. (2009). *Competency-based Training Guidelines for ICT Initiatives at the Community Level*. *ESCAP Technical Paper*. <http://www.unescap.org>.
- Wan Abdullah, W.A.A & M. Zhaffar, N (2018). *Inovasi Pendidikan Islam: Inspirasi dan Transformasi*. Kuala Lumpur: *Institut Terjemahan dan Buku Malaysia Berhad*.
- Yusof, M. N. M., & Tahir, Z. (2018). Kepentingan Penggunaan Media Sosial Teknologi Maklumat dalam Pendidikan IPTA. *e-Bangi*, 14(3), 1-10.

Repair of Pancreas Beta Cell Damage in Diabetes Mellitus Through Active Compounds of Mangosteen Skin Extract

Novera Herdiani

Department of Public Health, Faculty of Health, Universitas Nahdlatul Ulama Surabaya, Surabaya, Indonesia and Doctoral Program of Public Health, Universitas Airlangga, Surabaya, Indonesia

novera.herdiani@unusa.ac.id & novera.herdiani-2019@fkm.unair.ac.id

Bambang Wirjatmadi

Department of Public Health, Faculty of Public Health, Universitas Airlangga, Surabaya, Indonesia

merryanawirjatmadi@gmail.com

Kuntoro

Department of Public Health, Faculty of Public Health, Universitas Airlangga, Surabaya, Indonesia

kuntoro@fkm.unair.ac.id

Edza Aria Wikurendra

Department of Public Health, Faculty of Health, Universitas Nahdlatul Ulama Surabaya, Surabaya, Indonesia

ABSTRACT

Diabetes Mellitus (DM) is a major health problem worldwide. Poor control of blood glucose levels can eventually cause pancreatic -cell disorders, including a decrease in cell mass and function. Mangosteen rind which contains flavonoids can be used to protect and reduce damage to pancreatic beta cells, especially those caused by free radicals. This study aims to analyze the repair of pancreatic beta cell damage in diabetes mellitus through the active compound of mangosteen peel extract. The research methodology is laboratory experimental. The research design used was Randomized Post Test Only Control Group Design . Sample Wistar strain male white rats were 30 tails. Rats were grouped into 5 groups, namely negative control that did not receive any treatment, STZ induction without extract, STZ induction given mangosteen peel extract with 3 different doses of 200 mg/kg BW, 400 mg/kg BW, and 600 mg/kg. BB. Administration of therapy for 14 days orally . Antioxidant activity test of mangosteen peel extract by spectrophotometric method using DPPH. Repair of beta cell damage through HE staining. The results showed that the mangosteen peel extract contained antioxidant active compounds with an IC₅₀ value of 49.95 g/mL. After being given mangosteen peel extract, pancreatic beta cell damage decreased, namely the dose of 200 mg/kg BW/day reached 45.85%, the dose of 400 mg/kg BW/day reached 23.12%, while the dose of 600 mg/kg BW/day reached 23.12%. 30.28%. The administration of mangosteen peel extract gave a very significant response ($p < 0.01$) to the repair of beta cell damage in the pancreas of STZ-induced DM rats. The conclusion of this study is that mangosteen peel extract has the potential to repair pancreatic beta cell damage in STZ-induced DM. The effective dose of mangosteen peel extract is 400 mg/kgBW. Mangosteen peel can be used as an alternative herbal therapy for DM through standardized herbal drug testing stages.

Keywords: mangosteen; pancreatic beta cells; streptozotocin

INTRODUCTION

Diabetes Mellitus (DM) is a major health problem worldwide. DM is a group of metabolic diseases characterized by hyperglycemia resulting from impaired insulin secretion, insulin activity, or both (Kangralkar et al., 2010) . DM is associated with the occurrence of the inflammatory process. Destructive proinflammatory cytokines can affect insulin sensitivity and function of pancreatic beta cells (Kumawat et al., 2009) . DM with poor control of blood glucose levels can eventually cause pancreatic cell disorders, including a decrease in cell mass and function.

Damage to peripheral tissues is thought to be the result of an increase in free radicals in the body, which damage insulin receptors or glucose transporters found in cell membranes (Ueda-Wakagi et al., 2019) . Free radicals in excessive amounts will oxidize and attack the lipid components of cell membranes, resulting in lipid peroxidation (Zhong et al., 2019) . To reduce the damage caused by free radicals, antioxidants are needed (Alkadi, 2020) . Based on the International Diabetes Federation (IDF) stated that in 2005 in the world there were 200 million (5.1%) people with diabetes (diabetes) and it is estimated that 20 years later, namely in 2025, it will increase to 333 million (6.3%) people . Atlas, 2015) . The prevalence of diabetes mellitus, especially type 2 diabetes mellitus is rapidly increasing in industrialized and developing countries. By 2030, Indonesia will have 21.3 million people with DM (diabetes) (Ministry of Health, 2013) . The results of Riskesdas 2018 in Indonesia show that there is an increase in the prevalence of DM incidence from 6.9% in 2015 to 8.5% in 2018. The data for DM sufferers in Indonesia in 2018 was highest in DKI Jakarta with 40,210 cases (2.6%), Java East as many as 151,878 cases (2.0%), DI Yogyakarta 14,602 cases (2.4%), and North Sulawesi 9,542 cases (Yusuf et al., 2016).

Diabetes Mellitus is divided into 4 types, namely type 1 DM, type 2 DM, specific type DM, and gestational DM, but generally DM cases fall into 2 major groups, namely type 1 DM and type 2 DM. Type 1 DM is caused by the pancreas that produces insulin. in small amounts or not at all. Type 1 diabetes is an autoimmune disease with a mechanism initiated by inflammation of pancreatic beta cells that occurs due to inflation of mononuclear cells (macrophages, lymphocytes and monocytes) followed by beta cell death due to phagocytosis by macrophages (Kahaly & Hansen, 2016) . Type 1 diabetes occurs in 5%-10% of DM cases. Patients with type 1 diabetes absolutely require exogenous insulin administration. About 90%-95% of diabetics have type 2 diabetes, which is the most common type of diabetes. In type 2 DM, monotherapy or combination therapy is required for oral diabetes medication (OAD). If it has not succeeded in achieving the desired condition, it is necessary to give exogenous insulin (Z. Wang et al., 2018) . DM with poor control of blood glucose levels can eventually cause pancreatic cell disorders, including a decrease in cell mass and function (Ma et al., 2012) . Damage to pancreatic cells in type 2 DM can be caused by genetic factors, and other factors such as glucotoxicity, lipotoxicity (increased FFA), decreased incretin effect, changes in the Islet Amyloidoid Polypeptide (IAPP) process, Advanced Glycation End products (AGEs) and increased inflammatory cytokines. , insulin resistance, and others. In the end, all of these factors can cause metabolic stress I which will damage pancreatic cells (Berbudi et al., 2020) .

Streptozotocin (STZ) is a group of N-nitroso compounds which is a source of NO free radicals, used to induce hyperglycemia in experimental animals, because it is specifically toxic to pancreatic beta cells (Akbarzadeh et al., 2007) . Damage to pancreatic beta cells in mice as a result of streptozotocin induction is associated with the formation of peroxynitrite in the pancreas. Damage to pancreatic beta cells results in decreased insulin production resulting in

impaired glucose metabolism in the body resulting in DM disease (Roh et al., 2016) . Control of hyperglycemia has been proposed as an important step in the management of DM (Volpe et al., 2018) . DM management requires multidisciplinary management that includes non-drug therapy and drug therapy. Synthetic drugs have a short mechanism of action and are often accompanied by adverse side effects, which is why compounds from plants are used for the treatment of diabetes.

Based on previous research Kurniawati & Mahdi (2014) showed that the use of herbal medicine from mangosteen rind in patients with diabetes mellitus was able to control blood sugar levels. Other research has been done Chen et al., (2021) stated that the mangosteen rind proved effective in lowering blood glucose levels. Most studies examine blood glucose, but the problem is that it is not clear whether mangosteen rind is able to repair pancreatic beta cell damage through antioxidant mechanisms that occur simultaneously in the body, therefore further research still needs to be done. Traditional medicine is not a single active compound, the reaction process is slow in the body, besides that safety and cleanliness are not guaranteed (Xie et al., 2015) . So we need an active compound from extracts of natural ingredients that have gone through a process of separation and purification whose dosage has been determined through pre-clinical trials (tests on animals) to determine the level of safety, so it is still necessary to do research on experimental rats.

In connection with the above problems, it is necessary to find a supportive therapy that can accelerate healing and reduce the number of complications in people with Diabetes Mellitus. This study looked at the potential of mangosteen peel to repair pancreatic beta cell damage in STZ-induced diabetes mellitus. Research on the use of mangosteen rind for the treatment of Diabetes Mellitus in humans is still very limited, so as an early stage of an experiment to determine the benefits of giving mangosteen rind to repair damage to pancreatic beta cells, it will first be developed in experimental animals wistar rats.

METHOD

This research is a *true experimental study* using a completely randomized design with a *randomized posttest only control group design approach*. The research was conducted at the Biochemistry Laboratory, Airlangga University, Surabaya with Ethical Approval No. 655/HRECC.FODM/VIII/2022. White rats as experimental animals were acclimatized for one week in the laboratory. The rats were divided into five groups: (1) a negative control group that did not receive any treatment (K1), (2) a group of rats resulting from STZ induction without mangosteen peel extract as a positive control (K2), (3) a group of rats resulting from STZ induction that were given mangosteen rind extract at a dose of 200 mg/kg BW/day (K3), (4) The group of rats induced by STZ given mangosteen peel extract at a dose of 400 mg/kg BW/day (K4), (5) The group of rats induced STZ which was given mangosteen peel extract at a dose of 600 mg/kg BW/day (K5). The dose of Streptozotocin (STZ) used in this study was a single dose of 45 mg/kg BW which was used to induce male white rats (*Rattus norvegicus*) intraperitoneally to obtain treatment animals on blood glucose that had shown hyperglycemia.

Measurement of antioxidant activity spectrophotometrically using the free radical 1,1-diphenyl-2-picryl hydrazyl hydrate (DPPH). The antioxidant compounds in the extract will reduce DPPH radicals through the mechanism of hydrogen atom donation and cause color decay of DPPH from purple to yellow as measured using a UV-Vis spectrophotometer at a wavelength of 517 nm (Umesha et al., 2009) . Damage to pancreatic beta cells was seen in the number of damaged pancreatic beta cells in one field of view, observed by the *Hematoxylin*

Eosin (HE) staining method. Damaged beta cells are characterized by: smaller cell nucleus, abnormal shape, darker core color to no nucleus. The percentage of beta cell damage is calculated by the formula:

$$\% \text{ cell damage} = \frac{\text{number of damaged cells}}{\text{Number of cells in 1 field of view}} \times 100\%$$

Data from each parameter obtained were tested for normality and homogeneity between variants. Data showing normal distribution and variance between data did not differ (homogeneous) were analyzed by single-way Analysis of Variance (ANOVA) at 99% confidence, followed by Duncan's test. Data showing a normal distribution but variance between data are different (not homogeneous) were analyzed by Brown–Forsythe and followed by the Games–Howell test.

RESULTS AND DISCUSSION

Mangosteen Peel Extract Antioxidant Test

The antioxidant test results of mangosteen peel extract were carried out using the DPPH method with a concentration of 40 g/mL or 0.004% which was used as a standard solution for spectrophotometric antioxidant testing, where the smallest photometric error occurred at 0.005 as absorbance or 0.5% as transmittance. The addition of mangosteen peel extract solution into the DPPH solution caused the DPPH color to turn purple which was originally purple. The measurement results of antioxidant activity through the DPPH test using a spectrophotometer with: 517 nm showed that the mangosteen peel extract had antioxidant activity with an IC value of $IC_{50} = 49.95$ g/mL. IC_{50} is the effective concentration of the test material (sample) which can reduce DPPH free radicals by 50%. The results showed that the antioxidant activity of the mangosteen rind ethanol extract was greater than that of the water extract of the mangosteen rind which had an IC value of $IC_{50} = 393.2$ g/mL.

Mangosteen peel extract with a concentration of 49.95 g/mL can reduce 50% of DPPH free radicals. The attenuation is produced by the reaction between the DPPH molecule and the hydrogen atom released by the antioxidant compound which causes a break in the electron resonance in the DPPH molecule to form a molecule of 2,2 diphenyl-1 - picryl-hydrazine (Rohman et al., 2019) . The content of compounds in the ethanol extract of mangosteen peel which has antioxidant activity, namely flavonoids, because the structure of this compound has a conjugated double bonds. Research from Zarena & Sankar (2012) states that flavonoids are polyphenolic compounds that have antioxidant activity. Antioxidants can react with free radicals and form other reactive molecules that are more stable. Antioxidants capture free radicals with a series of reactions so that they can prevent cell damage due to oxidation by free radicals. The stability of this antioxidant containing electron radicals is due to the conjugated double bonds of compounds that function as antioxidants, so that the electron radicals can be delocalized (Thong et al., 2015) .

Flavonoid compounds have many double bonds in their aromatic rings, so they are very effective antioxidant compounds. The antioxidant activity of polyphenolic compounds is related to their chemical structure. In flavonoids, the presence of an *o* -hydroxy structure in ring B provides a high degree of stability to phenoxyl radicals through electron delocalization. This is an important property of anti-radicals (Tjahjani et al., 2014) . The 2,3-double bond with the conjugate system causes stability of the flavonoid phenoxyl radicals by conducting resonance, thereby increasing the activity of flavonoids as free radical scavengers. The chemical structure of flavonoid compounds as antioxidants is due to the presence of a 3' hydroxyl group, 4' (*ortho* - dihydroxy) in ring B of flavonoids, conjugated 2,3 double bonds

with a 4-oxo group (1,4-pyrone group) on ring C, and a hydroxyl group at positions 3 and 5 (Ahmed & Shakeel, 2012). The structure of flavonoids has two aromatic rings and several hydroxyl groups. A very potent antioxidant, capable of capturing various *Reactive Oxygen Species* (ROS). Flavonoids play an important role as anti-inflammatory, antitumor, and other pharmacological activities because of their antioxidant activity (Gill & Tuteja, 2010). It can be concluded that mangosteen peel extract contains antioxidant compounds as an antidote to free radicals.

Mangosteen Peel Extract Against Decreased Pancreatic Beta Cell Damage

Based on the results of the research conducted, it showed that STZ-induced rats had more damaged beta cells in the islets of Langerhans when compared to control rats and rats given ethanol extract of mangosteen rind, as shown below in Figure 1.

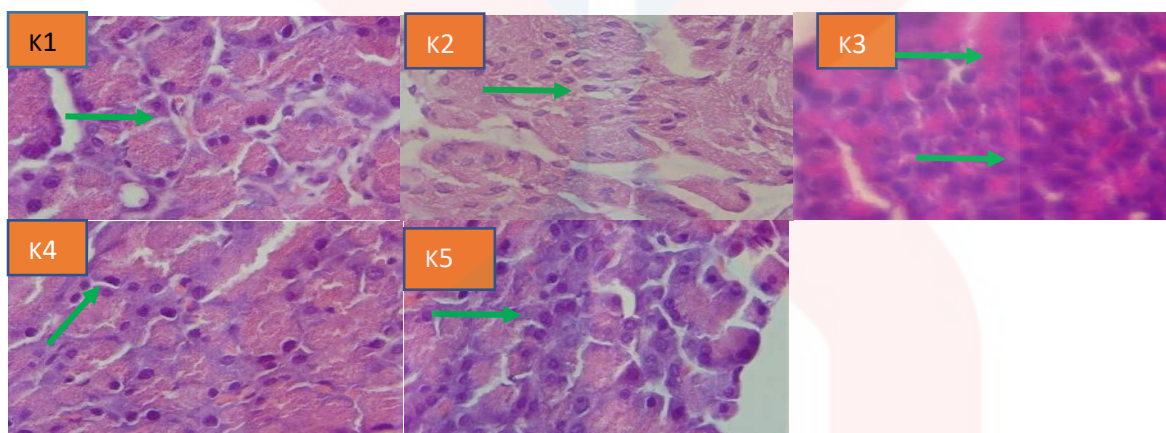

Figure 1. Histology of the Islets of Langerhans Pancreas Mice Ga lur Wistar

Information:

- K1 : The negative control group did not receive any treatment
- K2 : The group of rats induced by STZ without being given extract
- K3 : The group of rats induced by STZ + mangosteen peel extract at a dose of 200 mg/kg BW/day
- K4 : The group of rats induced by STZ + mangosteen peel extract at a dose of 400 mg/kg BW/day
- K5 : The group of rats induced by STZ + mangosteen peel extract at a dose of 600 mg/kg BW/day

Figure 1. shows the differences in histological images between pancreatic tissue in control rats, STZ-induced rats, and rats treated with ethanol extract of mangosteen rind. Histological picture showed that in the pancreas of STZ-induced rats, damage not only occurred to Langerhans beta cells but also to acinar cells. Damaged beta cells look darker in color than healthy cells. The number of damaged beta cells in STZ-induced rats was more so that Langerhans beta cells looked less compact when compared to control rats and rats given ethanol extract of mangosteen peel. The results of statistical analysis using single-lane ANOVA showed that the mangosteen peel ethanol extract gave a very significant response ($p < 0.01$) to the reduction of pancreatic beta cell damage in STZ-induced rats. The analysis was continued with Duncan's test to determine the different responses of the mangosteen peel ethanol extract with different doses to the reduction of pancreatic beta cell damage in STZ-induced rats. The results of the analysis are presented in Table 1.

Table 1. Duncan test results on pancreatic beta cell damage

Group	n	Mean ± SD	P-value Analysis of Variance
K1	6	15.84 ^a ± 4.42	< 0.01
K2	6	75.69 ^d ± 6.73	
K3	6	45.85 ^c ± 9.46	
K4	6	23.12 ^{ab} ± 2.21	
K5	6	30.28 ^b ± 7.82	

Table 1. shows the results of further analysis using Duncan 5%, that STZ-induced rats given ethanol extract of mangosteen peel at a dose of 400 mg/kg BW/day and a dose of 600 mg/kg BW/day had the same response but showed different responses. with the administration of mangosteen peel ethanol extract at a dose of 200 mg/kg BW/day. The group of rats that were given a dose of 400 mg/kg BW/day had the same notation as the control rats, meaning that the administration of ethanol extract at a dose of 400 mg/kg BW/day was able to reduce pancreatic beta cell damage the same as the control rats.

The percentage of pancreatic beta cell damage in each group of treated mice is presented in Figure 2.

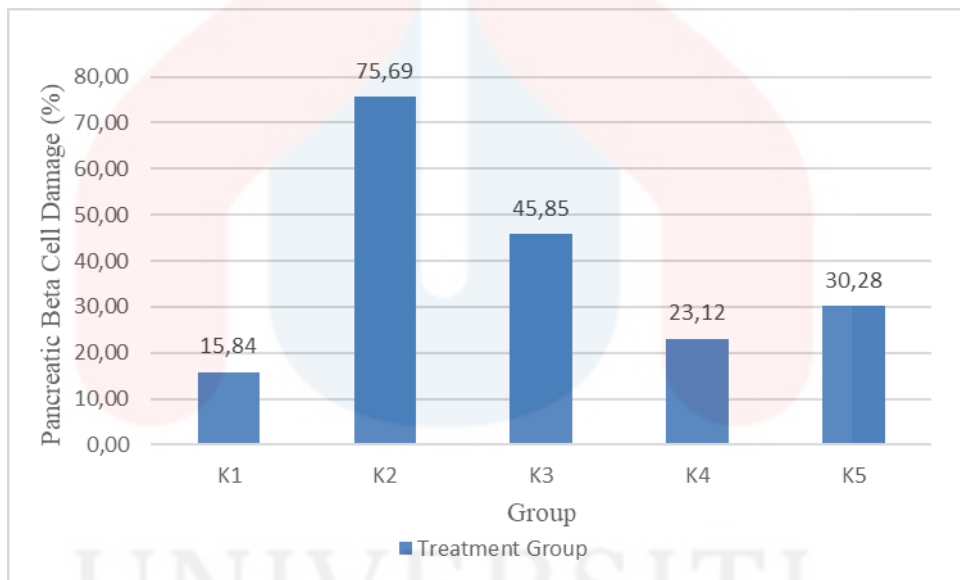

Figure 2. Percentage of Damage to Pancreatic Beta Cells in Various Treatment Groups of Rats

Figure 2. shows the percentage of pancreatic beta cell damage in rats induced by STZ in the K2 group reached 75.69%, after being given ethanol extract of mangosteen rind, pancreatic beta cell damage decreased. In STZ-induced rats given mangosteen peel extract at a dose of 200 mg/kg BW/day beta cell damage reached 45.85%, a dose of 400 mg/kg BW/day beta cell damage reached 23.12%, while a dose of 600 mg/day kg BW/day beta cell damage is 30.28%.

The results showed that the damage to pancreatic beta cells in STZ-induced DM rats reached 75.69%. Histological observations also showed that the mass of pancreatic beta cells in Langerhans Island DM rats was greatly reduced when compared to control rats. According to research by Cosentino & Regazzi (2021) explained that insulinitis will be followed by the death of pancreatic beta cells due to phagocytosis of macrophages so that the mass of pancreatic beta cells in the islets of Langerhans is reduced. The decrease in beta cells in STZ-induced DM rats was caused by an increase in NO levels, NO will react with superoxide to form ONOO-radicals, causing an increase in peroxynitrite radicals in the cytoplasm. Peroxynitrite is highly reactive, causing damage and death in beta cells (Stancill et al., 2020) . According to Szczuko

et al., (2019) stated that beta cells are less able to eliminate radical compounds because they contain only a small amount of glutathione and low glutathione peroxidase activity as an enzymatic antioxidant. Beta cell damage and death is actually also followed by a regeneration process, but the number of regenerated cells is not balanced with the number of dead cells so that beta cell damage still occurs. The results of research by Wang et al., (2016) showed that 60% damage to pancreatic beta cells would be followed by an increase in cell proliferation by 40%.

After administration of ethanol extract of mangosteen peel in DM rats there was an improvement in pancreatic beta cells, this can be seen from the results of histological observations which showed that the mass of beta cells became denser in DM rats given ethanolic extract of mangosteen peel (Figure 1). The administration of mangosteen rind ethanol extract up to a dose of 400 mg/KgBW showed an increase in beta cell repair, this was indicated by a decrease in the percentage of beta cell damage from 75.69% to 23.12%. The ethanol extract of mangosteen rind at a dose of 400 mg/kgBW was the optimum dose for repairing beta cell damage because statistically the average beta cell damage was not significantly different from that of control rats. The decrease in beta cell damage due to the administration of ethanol extract of mangosteen peel in rats induced by STZ is related to the active content of s in the extract. Flavonoids that act as antioxidants can help enzymatic antioxidants in capturing free radicals such as NO so that the formation of peroxynitrite radicals can be avoided and beta cell damage and death due to peroxynitrite can be prevented.

The hydroxyl group on the aromatic ring of flavonoid compounds donates H atoms to free radicals, and flavonoid phenoxyl radicals are formed. The new radicals formed then undergo resonance stabilization by a conjugated double bond system so that these radicals are less reactive. Flavonoids in addition to being antioxidants can also increase the activity of enzymatic antioxidants such as glutathione peroxidase and SOD (Ighodaro & Akinloye, 2018) . The active compound content of mangosteen peel ethanol extract can prevent and reduce pancreatic beta cell damage due to excess free radicals. This study also showed that in healthy mice as a control damage to pancreatic beta cells also occurred even though the damage was less than 25% (score 1). Damage to pancreatic beta cells in healthy mice did not cause disturbances in insulin production because it was always followed by balanced beta cell regeneration (Semwal et al., 2021) .

The decrease in the degree of damage to pancreatic beta cells in DM rats given the mangosteen peel ethanol extract was not directly at 0 but gradually started from the damage degrees to scores of 3, 2, and 1 (Taher et al., 2016) . This decreasing process shows that mangosteen peel extract provides a process of gradual repair and regeneration of pancreatic beta cells , resulting in a decrease in pancreatic beta cell damage . The ethanol extract of mangosteen rind at a dose of 400 mg/kgBW is an effective dose to reduce beta cell damage .

CONCLUSION

Mangosteen peel extract contains antioxidant active compounds that can reduce free radicals in pancreatic tissue. Oxidative stress can be prevented by reducing free radicals in pancreatic tissue, thereby repairing pancreatic beta cell damage in diabetes mellitus.

ACKNOWLEDGMENT

We thanks Universitas Airlangga Surabaya and Universitas Nahdlatul Ulama Surabaya for their permission and research support.

REFERENCES

- Ahmed, S., & Shakeel, F. (2012). Antioxidant activity coefficient, mechanism, and kinetics of different derivatives of flavones and flavanones towards superoxide radical. *Czech Journal of Food Sciences*, 30(2), 153–163.
- Akbarzadeh, A., Norouzian, D., Mehrabi, M. R., Jamshidi, S., Farhangi, A., Verdi, A. A., Mofidian, S. M. A., & Rad, B. L. (2007). Induction of diabetes by Streptozotocin in rats. *Indian Journal of Clinical Biochemistry*, 22(2), 60–64. <https://doi.org/10.1007/BF02913315>
- Alkadi, H. (2020). A review on free radicals and antioxidants. *Infectious Disorders-Drug Targets (Formerly Current Drug Targets-Infectious Disorders)*, 20(1), 16–26.
- Atlas, D. (2015). International diabetes federation. *IDF Diabetes Atlas, 7th Edn. Brussels, Belgium: International Diabetes Federation*, 33.
- Berbudi, A., Rahmadika, N., Tjahjadi, A. I., & Ruslami, R. (2020). Type 2 diabetes and its impact on the immune system. *Current Diabetes Reviews*, 16(5), 442.
- Chen, S.-P., Lin, S.-R., Chen, T.-H., Ng, H.-S., Yim, H.-S., Leong, M. K., & Weng, C.-F. (2021). Mangosteen xanthone γ -mangostin exerts lowering blood glucose effect with potentiating insulin sensitivity through the mediation of AMPK/PPAR γ . *Biomedicine & Pharmacotherapy*, 144, 112333.
- Cosentino, C., & Regazzi, R. (2021). Crosstalk between macrophages and pancreatic β -cells in islet development, homeostasis and disease. *International Journal of Molecular Sciences*, 22(4), 1765.
- Gill, S. S., & Tuteja, N. (2010). Reactive oxygen species and antioxidant machinery in abiotic stress tolerance in crop plants. *Plant Physiology and Biochemistry*, 48(12), 909–930.
- Ighodaro, O. M., & Akinloye, O. A. (2018). First line defence antioxidants-superoxide dismutase (SOD), catalase (CAT) and glutathione peroxidase (GPX): Their fundamental role in the entire antioxidant defence grid. *Alexandria Journal of Medicine*, 54(4), 287–293.
- Kahaly, G. J., & Hansen, M. P. (2016). Type 1 diabetes associated autoimmunity. *Autoimmunity Reviews*, 15(7), 644–648.
- Kangralkar, V. A., Patil, S. D., & Bandivadekar, R. M. (2010). Oxidative stress and diabetes: a review. *Int J Pharm Appl*, 1(1), 38–45.
- Kemenkes, R. I. (2013). *Riset Kesehatan Dasar. Jakarta: Badan Penelitian dan Pengembangan Kesehatan Kementerian Kesehatan RI. 25 Juli 2015.*
- Kumawat, M., Bala Pahwa, M., Singh Gahlaut, V., & Singh, N. (2009). Status of antioxidant enzymes and lipid peroxidation in type 2 diabetes mellitus with micro vascular complications. *The Open Endocrinology Journal*, 3(1).
- Kurniawati, M., & Mahdi, C. (2014). The effect of juice mangosteen rind (*Garcinia mangostana* L.) to blood sugar levels and histological of pancreatic rats with the induction of streptozotocin. *The Journal of Pure and Applied Chemistry Research*, 3(1), 1.
- Lukiati, B., Nugrahaningsih, N., & Arifah, S. N. (2019). The Role of *Sechium edule* Fruits Ethanolic Extract in Insulin Production and Malondialdehyde Level in Stz-Induced Diabetic Rat. *Journal of Tropical Biodiversity and Biotechnology*, 4(1), 11–17.
- Ma, Z. A., Zhao, Z., & Turk, J. (2012). Mitochondrial dysfunction and β -cell failure in type 2 diabetes mellitus. *Experimental Diabetes Research*, 2012.
- Roh, S.-S., Kwon, O. J., Yang, J. H., Kim, Y. S., Lee, S. H., Jin, J.-S., Jeon, Y.-D., Yokozawa, T., & Kim, H. J. (2016). *Allium hookeri* root protects oxidative stress-induced inflammatory responses and β -cell damage in pancreas of streptozotocin-induced diabetic rats. *BMC Complementary and Alternative Medicine*, 16(1), 1–10.

- Rohman, A., Rafi, M., Alam, G., Muchtaridi, M., & Windarsih, A. (2019). Chemical composition and antioxidant studies of underutilized part of mangosteen (*Garcinia mangostana* L.) fruit. *Journal of Applied Pharmaceutical Science*, 9(8), 47–52.
- Semwal, D. K., Kumar, A., Aswal, S., Chauhan, A., & Semwal, R. B. (2021). Protective and therapeutic effects of natural products against diabetes mellitus via regenerating pancreatic β -cells and restoring their dysfunction. *Phytotherapy Research*, 35(3), 1218–1229.
- Stancill, J. S., Happ, J. T., Broniowska, K. A., Hogg, N., & Corbett, J. A. (2020). Peroxiredoxin 1 plays a primary role in protecting pancreatic β -cells from hydrogen peroxide and peroxynitrite. *American Journal of Physiology-Regulatory, Integrative and Comparative Physiology*, 318(5), R1004–R1013.
- Szczuko, M., Zapalowska-Chwyc, M., & Drozd, R. (2019). A low glycemic index decreases inflammation by increasing the concentration of uric acid and the activity of glutathione peroxidase (GPx3) in patients with polycystic ovary syndrome (PCOS). *Molecules*, 24(8), 1508.
- Taher, M., Tg Zakaria, T. M. F. S., Susanti, D., & Zakaria, Z. A. (2016). Hypoglycaemic activity of ethanolic extract of *Garcinia mangostana* Linn. in normoglycaemic and streptozotocin-induced diabetic rats. *BMC Complementary and Alternative Medicine*, 16(1), 1–12.
- Thong, N. M., Quang, D. T., Bui, N. H. T., Dao, D. Q., & Nam, P. C. (2015). Antioxidant properties of xanthenes extracted from the pericarp of *Garcinia mangostana* (Mangosteen): a theoretical study. *Chemical Physics Letters*, 625, 30–35.
- Tjahjani, S., Widowati, W., Khiong, K., Suhendra, A., & Tjokropranoto, R. (2014). Antioxidant properties of *Garcinia mangostana* L (mangosteen) rind. *Procedia Chemistry*, 13, 198–203.
- Ueda-Wakagi, M., Nagayasu, H., Yamashita, Y., & Ashida, H. (2019). Green tea ameliorates hyperglycemia by promoting the translocation of glucose transporter 4 in the skeletal muscle of diabetic rodents. *International Journal of Molecular Sciences*, 20(10), 2436.
- Umesha, K. B., Rai, K. M. L., & Nayaka, M. A. H. (2009). Antioxidant and Antimicrobial Activity of 5-methyl-2-(5-methyl-1, 3-diphenyl-1H-pyrazole-4-carbonyl)-2, 4-dihydro-pyrazol-3-one. *International Journal of Biomedical Science: IJBS*, 5(4), 359.
- Volpe, C. M. O., Villar-Delfino, P. H., Dos Anjos, P. M. F., & Nogueira-Machado, J. A. (2018). Cellular death, reactive oxygen species (ROS) and diabetic complications. *Cell Death & Disease*, 9(2), 1–9.
- Wang, J., Yang, X., & Zhang, J. (2016). Bridges between mitochondrial oxidative stress, ER stress and mTOR signaling in pancreatic β cells. *Cellular Signalling*, 28(8), 1099–1104.
- Wang, Z., Sun, J., Han, R., Fan, D., Dong, X., Luan, Z., Xiang, R., Zhao, M., & Yang, J. (2018). Efficacy and safety of sodium-glucose cotransporter-2 inhibitors versus dipeptidyl peptidase-4 inhibitors as monotherapy or add-on to metformin in patients with type 2 diabetes mellitus: a systematic review and meta-analysis. *Diabetes, Obesity and Metabolism*, 20(1), 113–120.
- Xie, Z., Sintara, M., Chang, T., & Ou, B. (2015). Daily consumption of a mangosteen-based drink improves in vivo antioxidant and anti-inflammatory biomarkers in healthy adults: a randomized, double-blind, placebo-controlled clinical trial. *Food Science & Nutrition*, 3(4), 342–348.
- Yusuf, S., Okuwa, M., Irwan, M., Rassa, S., Laitung, B., Thalib, A., Kasim, S., Sanada, H., Nakatani, T., & Sugama, J. (2016). Prevalence and risk factor of diabetic foot ulcers in a regional hospital, eastern Indonesia. *Open Journal of Nursing*, 6(1), 1–10.

- Zafar, M., & Naqvi, S. N.-H. (2010). Effects of STZ-induced diabetes on the relative weights of kidney, liver and pancreas in albino rats: a comparative study. *International Journal of Morphology*, 28(1).
- Zarena, A. S., & Sankar, K. U. (2012). Phenolic acids, flavonoid profile and antioxidant activity in mangosteen (*Garcinia mangostana* L.) pericarp. *Journal of Food Biochemistry*, 36(5), 627–633.
- Zhong, S., Li, L., Shen, X., Li, Q., Xu, W., Wang, X., Tao, Y., & Yin, H. (2019). An update on lipid oxidation and inflammation in cardiovascular diseases. *Free Radical Biology and Medicine*, 144, 266–278.



Surveying and analyzing of factors related to holistic active aging preparation of working adults in Nakhon Nayok province of Thailand

Ormjai Taejarernwiriyaikul

Division of Health Promotion, Faculty of Physical Therapy, Srinakharinwirot University
E-mail: ormjai@g.swu.ac.th

Sirikul Thummajitsakul

Division of Health Promotion, Faculty of Physical Therapy, Srinakharinwirot University
Email: sirikult@g.swu.ac.th

Sunisa Songsaigath

Division of Health Promotion, Faculty of Physical Therapy, Srinakharinwirot University
Email: sunisaso@g.swu.ac.th

Pakarang Srimee

Division of Health Promotion, Faculty of Physical Therapy, Srinakharinwirot University
Email: pakarang@g.swu.ac.th

Rattiporn Kosuwin

Division of Health Promotion, Faculty of Physical Therapy, Srinakharinwirot University
Email: rattiporn@g.swu.ac.th

Pattakorn Buppan

Division of Health Promotion, Faculty of Physical Therapy, Srinakharinwirot University
Email: pattakorn@g.swu.ac.th

Yuparat Odglun

Division of Health Promotion, Faculty of Physical Therapy, Srinakharinwirot University
Email: yaparat@g.swu.ac.th

Supim Wongtongtair

Division of Health Promotion, Faculty of Physical Therapy, Srinakharinwirot University
Email: supim@g.swu.ac.th

Piyanuch Yoadsomsuay

Division of Health Promotion, Faculty of Physical Therapy, Srinakharinwirot University
Email: piyanuchy@g.swu.ac.th

Pimonporn Chaovipoch

Division of Health Promotion, Faculty of Physical Therapy, Srinakharinwirot University
Email: pimonpor@g.swu.ac.th

Sukalya Kritsnakriengkrai

Division of Physical Therapy, Faculty of Physical Therapy, Srinakharinwirot University
Email: sukalya@g.swu.ac.th

Surasak Yooyongsatit

Department of Microbiology, Faculty of Medicine, Srinakharinwirot University
Email: surasaky@g.swu.ac.th

ABSTRACT

Background: The situation of current population indicated that the birth rate was decreasing whereas the elderly population was with increasing trend. Such change in population structure might cause many undesirable effects in the society; and efforts to mitigate the problems should be considered. The objectives of the research were 1) to study the preparation (nutrition, exercise, emotion, active aging and stable assurances) for becoming an elderly person 2) study the factor (social and economic) related to the elderly preparation of the working adults in Nakhon Nayok province of Thailand. Methods: The study samples were 173 persons aged between 18-59 years old, selected by convenience sampling. Data were collected by questionnaire and analyzed by descriptive statistic, chi square test and Pearson correlation. Reliability testing was performed by using KR-20 was 0.71 and Cronbach's alpha coefficient was 0.85. Statistical significance level was set at 0.05. Results: The results revealed that, the level of knowledge test for becoming an elderly person was in overall moderate. The knowledge test of emotion, exercise and active aging were all at moderate level. The knowledge test of stable assurances was at low level. Sex, educational level, occupation, annual physical examination, childbearing, work demand of elderly, family debt, relationship of family members and monthly income related to the knowledge test for becoming an elderly person. Conclusion: Research suggests that health care providers should promote activities for improving the quality of life and enhance them regarding financial preparation in order to be the healthy elderly.

Keywords: Working adult; Demographic factors; Social factors; Economic factors; Knowledge about well-being for holistic active aging preparation

INTRODUCTION

The population of Thailand in 2021 represent approximately 66.19 million, which consist of older persons (≥ 60 years) at 17.58 % of total Thai people, and working adult (15-59 years) at 64.44%¹. For Nakhon Nayok province of Thailand has approximately 260,081 people which consist of older persons (≥ 60 years) at 20.15% and working adult at 63.61% of total people in Nakhon Nayok province¹. To date, developing of medicine and public health help to Thai people to have a long life, and new Thai generation have more popularity in freedom lifestyle and fewer children that can effect on Thai population structure².

Additionally, it has reported that significantly negative correlation between income and social determinant of active aging was found³. However, other factors can effect on decreasing of active aging such as health problems from non-communicable diseases (i.e. diabetic disease, obesity and hyperlipoproteinemia), which diseases occurred from lifestyles i.e. food consumption, exercise, and emotional management. Currently, the pandemic of the coronavirus disease 2019 (COVID-19) effects on economic status of Thailand leading to Thai people have low income and high expenditure.

However, the life quality and well-being of aging people was explained by ageing well, which consists of successful ageing, healthy ageing, positive ageing, productive ageing, and active ageing⁴⁻⁸. Active ageing is defined by World Health Organization (WHO) as the method of optimizing chance to improve life quality of people age in health, participation and security.⁹⁻¹⁰ Therefore, well-being, social participant and security of working adult have been continuously prepared to be active aging. Working adult is a major part of population structure to drive economic of Thailand. However, workload and exhaustion of working adults can effect on nutrition and physical activity behaviors that cause to overweight.¹¹ Life quality of working adults is an important basis for active aging. Therefore, our objectives were to survey factors

related to holistic active aging preparation of working adult in Nakhon Nayok province of Thailand to increase people awareness about the obtained knowledge in working adults in Nakhon Nayok province of Thailand. Holistic preparation of active aging is the planning process of being active aging in social, economic and knowledge of well-being.

METHOD

Ethical Considerations

This study was approved by ethical committees in Faculty of Physical Therapy Srinakharinwirot University (PTHP2021-001). The respondents received an electronic information about objectives and method of the research to request for participation in the study with a Google drive form link. After the respondents provided consent, they complete the online questionnaire via smartphone, tablets and computers. However, the respondents have a right to withdraw from the research at any time or have a right to refuse to answer the online questionnaire.

Questionnaire

The online questionnaire consists of 4 parts: 1) demographic data, 2) social factors, 3) economic factors, and 4) knowledge test of wellbeing, active aging and stable assurances. Demographic data (e.g. sex, marital status, religion, educational level, congenital disease, medical examination, characteristics of residence, occupation) was expressed by alternative questions and open questions. Social factors (number of children, work status, types of housing, duration of stay in the community, relationship of family members) were expressed by alternative questions and likert scale survey questions which consisted of 5 levels namely 1) practicing rarely to never (there were initiatives and preparations for practice), 2) practicing once in a while (there is at least 2-3 preparations and practices), 3) practicing sometimes (practicing at least 1-2 times a week), 4) practicing often (practicing at least 3 times a week), and 5) practicing regularly (practicing every day or at least 4-5 times a week). The economic factors (source of income, work demand of elderly, monthly income, sufficiency of income, family debt, financial status preference, saving money) was expressed by alternative questions and open questions. The knowledge test of wellbeing (nutrition, exercise, emotion), active aging (mean and attribute) and stable assurances (generating insurance, prestige of elderly in social, financial and acceptance of need responds according to the right) were expressed by alternative questions (yes or no). Level of knowledge test was classified into 3 level 1) good level (81-100%) 2) moderate level (61-80%) 3) low level (0-60%). The questionnaire was approved by three experts in the same field of the study. Reliability testing was performed by using KR-20 was 0.71 and Cronbach's alpha coefficient was 0.85.

Sample size and sampling

Inclusion criteria of this study were working adults both males and females aged 18-59 years who were nondisabled, not retired, not full-time homemakers and students, and worked in Nakorn Nayok province. For exclusion criteria, subjects who provide incompletely data. The current study was restricted in Nakorn Nayok province. Sample size for this study was calculated by using the formula of Yamane (1973) at 95% confidence interval and acceptable error of 5%.¹²⁻¹³ The calculation revealed that sample size was 173.

Data analysis

Data were analyzed using descriptive statistics, Chi-square test, and Pearson's correlation tests. Statistical significance was set at $< .05$.

RESULTS

Data of demographic characteristics showed that, most of the sample were female (62.4%), Buddhists (94.8%), married (50.9%), living in a detached house (84.4%), having a homeowner status (53.8%) and government service/state enterprise (39.3%), With regard to education level, 45.7% were undergraduates. 71.7% participants had congenital disease (e.g. diabetes, high blood pressure, hyperlipidemia) and 54.3% no health check. About 70.5% work in Ongkharak District, Nakhon Nayok Province, Thailand.

The knowledge test of active aging showed that, level of knowledge test for becoming an elderly person was in overall moderate. The knowledge test of active aging was classified into of nutrition, exercise, emotion, active aging and stable assurances. The knowledge test of emotion, exercise and active aging were all at moderate level. The knowledge test of stable assurances was at low level (Table 1).

Table 1: Active aging preparation of working adults (n=173)

Knowledge test for active aging preparation	mean	S.D.	level
Emotion	10.7	1.7	moderate
Exercise	8.1	1.8	moderate
Nutrition	6.1	1.5	low
Active aging	7.8	1.3	moderate
Stable assurances	6.2	0.9	low
Total	39.0	4.8	moderate

Note: The level of the knowledge test of nutrition, exercise, active aging and stable assurances score was as follows: 0-6 = low level, 7-8 = moderate level, 9-10 = good level respectively. The level of the knowledge test of emotion score was as follows: 0-9 = low level, 10-12 = moderate level, 13-15 = good level respectively. The level of the total knowledge test for active aging preparation score was as follows: 0-33 = low level, 34-44 = moderate level, 45-55 = good level respectively.

The study used Chi-square analyzed relationship between factors and the knowledge test for active aging preparation showed that, annual physical examination and area work were significantly related with emotion. Sex, childbearing, work demand of elderly and family debt were significantly related with exercise. Sex, childbearing, work demand of elderly, and family debt were significantly related with nutrition. Education level and occupation were significantly related with active aging (Table 2).

Table 2: factors associated with active aging preparation of working adults using Chi-square statistics (n=173)

Factors	N	%	Emotion	Exercise	Nutrition	Active aging	Stable assurances
demographic characteristics							
sex			1.126 ^a	6.301 ^{a*}	6.301 ^{a*}	2.993 ^a	4.067 ^a

Factors	N	%	Emotion	Exercise	Nutrition	Active aging	Stable assurances
male	65	36.7					
female	108	62.4					
Education level			6.817 ^a	8.078 ^a	8.078 ^a	27.583 ^{a*}	4.858 ^a
lower than elementary school	4	2.3					
primary school	18	10.4					
secondary education	29	16.8					
diploma	18	10.4					
Bachelor's degree	79	45.7					
postgraduate	25	14.5					
occupation			14.530 ^a	11.535 ^a	11.535 ^a	29.728 ^{a*}	13.954 ^a
gardening/farming/ farming/raising animals	11	6.4					
general employee	23	13.3					
government service/state enterprise	68	39.3					
work in a factory/private company	25	14.5					
selling / running my own business	14	8.1					
housework/Housewife	4	2.3					
other	28	16.1					
annual physical examination			11.413 ^{a*}	3.256 ^a	3.256 ^a	1.219 ^a	3.461 ^a
yes	79	45.7					
no	94	54.3					
area work			25.866 ^{a*}	12.282 ^a	12.282 ^a	13.757 ^a	6.778 ^a
Mueang Nakhon	29	16.8					
Nayok District							
Ban Na District	14	8.1					
Pak Phli District	3	1.7					
Ongkharak District	122	70.5					
other	5	2.9					
social factor							
childbearing			.118 ^a	6.676 ^{a*}	6.676 ^{a*}	3.291 ^a	.276 ^a
No	88	50.9					
Yes	85	49.1					
Economic factors							
work demand of elderly			3.517 ^a	6.507 ^{a*}	6.507 ^{a*}	2.091 ^a	2.777 ^a
yes	76	43.9					
no	97	56.1					
family debt			1.559 ^a	7.445 ^{a*}	7.445 ^{a*}	1.967 ^a	.309 ^a
yes	67	38.7					
no	106	61.3					

a chisquare test, *p < 0.05

The study used Pearson correlation analyzed relationship between factors and the knowledge test for active aging preparation showed that, relationship of family members was significantly related with exercise. Monthly income was significantly related with stable assurances and active aging (Table 3).

Table 3 Pearson's product moment correlation coefficient between active aging preparation of working adult and related factors (n=173)

Factors	The knowledge test for active aging preparation				
	emotion	exercise	nutrition	active aging	stable assurances
	R	R	R	R	R
Duration of stay in the community	.016	.035	-.137	-.079	-.057
Relationship of family members	.032	-.168*	-.131	-.086	-.031
Monthly income	-.026	.122	.144	.191*	.479**

*p < 0.05, **p < 0.01

DISCUSSION

Preparing to enter an aging society with quality, aims to create awareness to people in society. Realized the importance of the elderly and to enable the elderly to live with dignity self-reliant which is considered to create collateral and create stability in the life of the elderly should start as early as possible the latest is adulthood. If you realize the importance of Prepare to enter an aging society by gaining knowledge or suitable suggestion. It will allow that person to adjust with changes in physical, mental, emotional, social and economy properly and can be self-reliant for a long time and good quality.

The preparation for becoming an elderly person was in overall moderate. The finding was similar to the results of many previous studies.14-18 Preparation for becoming an elderly person (emotion exercise nutrition active aging stable assurances) for becoming an elderly person, there were 10 factors significantly related which included annual physical examination, area of work, sex, educational level, occupation, childbearing, work demand of elderly, family debt, relationship of family members and monthly income. The reason might be due to the working adult is physically prepared to enter a healthy old age. By choosing food according to nutrition keep exercising and have an annual health check plan for extra income. Because at present there is a health promotion campaign for people of all age groups. Especially the working age to be aware of the exercise, nutritious and good mental health. To be a healthy elderly person and the working age began to look at their future to be stable. Therefore, various preparations have been made to enable them to be able to live happily in the future. Not a burden on the family especially the economic preparation because when healthy, will be able to work more. Able to pursue additional careers make more income is an elderly person who has potential. In addition, to the fact that most of the samples had a bachelor's degree, government service or company employees quite stable. Thus, they have knowledge to prepare themselves for health care in order to have good health and potential. This is consistent with the results of the study by Arparat Ingkapakorn and Nath Bhanthumnavin (2019),17 which found that educational level variables were positively correlated with Preparing to be a potential senior citizen that is, a higher education level is more health-prepared to become a potential senior citizen than a person with a lower or lower level of education.

Research suggests that health care providers should promote activities for improving the quality of life and enhance them regarding financial preparation in order to be the healthy elderly.

CONCLUSION

The study aimed to surveying and analyzing of factors related to holistic active aging preparation of working adults in Nakhon Nayok province of Thailand. The level of knowledge test for becoming an elderly person was in overall moderate. Sex, educational level, occupation, annual physical examination, childbearing, work demand of elderly, family debt, relationship of family members and monthly income related to the knowledge test for becoming an elderly person.

REFERENCES

- Official Statistics Registration Systems [Internet]. Official statistics registration systems. [cited 2022 Mar 7]. Available from: <https://stat.bora.dopa.go.th/stat/statnew/statMONTH/statmonth/#/displayData>
- Foundation of Thai Gerontology Research and Development institute [Internet]. Situation of The Thai elderly 2020. [cited 2022 Mar 7]. Available from: <https://thaitgri.org/>.
- Hiroshi H, Katsunori K, Ichiro K. Social Determinants of Active Aging: Differences in Mortality and the Loss of Healthy Life between Different Income Levels among Older Japanese in the AGES Cohort Study. *Active Aging: A Global Goal 2012*. 2012; Aug:1-9. Article ID 701583. <https://doi.org/10.1155/2012/701583>
- Wongsala, M., Anbäcken, E.M., Rosendahl, S. Active ageing – perspectives on health, participation, and security among older adults in northeastern Thailand – a qualitative study. *BMC Geriatrics* 2021; 21:41.
- Rowe JW, Kahn RL. Successful aging 2.0: conceptual expansions for the 21st century. *J Gerontol Ser B Psychol Sci Soc Sci*. 2015; 70:593–6.
- World Health Organization [Internet]. World report on ageing and health. Geneva; 2015. [cited 2022 Mar 7]. Available from: <https://www.who.int/ageing/publications/world-report-2015/en/>.
- Walker A. A strategy for active ageing. *Int Soc Secur Rev*. 2002; 55: 121–39.
- Foster L, Walker A. Active and successful aging: a European policy perspective. *The Gerontologist*. 2014; 55:83–90.
- WHO. Active Aging: A Policy Framework. Geneva: World Health Organization (2002).
- Thanakwang K, Isaramalai S, Hatthakit U. Thai cultural understandings of active ageing from the perspectives of older adults: a qualitative study. *Pacific Rim Int J Nurs Res*. 2014; 18:152–65.
- Padilla HM, Wilson M, Vandenberg RJ, Davis M, Clark MA. Health behavior among working adults: Workload and exhaustion are associated with nutrition and physical activity behaviors that lead to weight gain. *Journal of health psychology*. *Journal of health psychology*. 2021; 26(6):892-904.
- Yamane, T. (1973) *Statistics: An Introductory Analysis*. 3rd Edition, Harper and Row, New York.
- Yamane, Taro (1973). “Statistics: an introductory analysis.” New York: Harper & Row.
- Donnapa Chaisombut Buaban Yana. 2019. Factors Related to the Preparation for Aging among Pre-aging Population. *Journal of the Ministry of Public Health*. 29(3):131-43.
- Chaiwat Onthaisomg Kanyarat Sornkla Sureerat Suebsun Woranart Promsuan. 2020. The preparation for entering the aging society of the population in Mueang District, Surin

- Province. *Journal of Nursing and Health Care*. 38(2): 53-62.
- Authumporn Wanitchakham, 2019. Preparation for Aging Society: A Case Study of Sai Mai District Bangkok. *APHEIT Journal*; 25(1): 164-79.
- Arparat Ingkapakorn, Nath Bhanthumnavin. 2019. Factors Influencing the Preparation for Elderly of Working People: A Case Study of Sai Mai District, Bangkok. *Journal of Health Science* 28(1):22-36.
- Tiraphat S, Kasemsup V, Buntup D, Munisamy M, Nguyen TH, Hpone Myint A. Active Aging in ASEAN Countries: Influences from Age-Friendly Environments, Lifestyles, and Socio-Demographic Factors. *International journal of environmental research and public health*. 2021; 18(16): 82-90.



Journalist Competence, Press Professionalism, and Social Responsibility: A Conceptual Paper

Eka Putra

*Faculty of Communication Science, Universitas Muhammadiyah Riau,
Pekanbaru 28000, Indonesia*

*Faculty of Language Studies and Human Development, Universiti Malaysia Kelantan,
Bachok, Kelantan 16300, Malaysia
e19e0028f@siswa.umk.edu.my*

Azman Bidin

*Faculty of Language Studies and Human Development, Universiti Malaysia Kelantan,
Bachok, Kelantan 16300, Malaysia
azman.bidin@umk.edu.my*

ABSTRAK

Terwujudnya profesionalisme akhbar merupakan harapan besar bagi masyarakat akhbar Indonesia. Dewan Pers telah merangka banyak langkah dan melaksanakannya untuk meningkatkan mutu kewartawanan dan mutu wartawan sebagai peneraju akhbar. Konsep kompetensi wartawan telah diterapkan dengan mensasarkan 17,000 wartawan yang mengambil ujian kompetensi wartawan. Penyebaran pensijilan kompetensi wartawan kepada kebanyakan wartawan dan pihak berkepentingan kewartawanan sentiasa digalakkan supaya semua wartawan diharapkan mempunyai pensijilan kompetensi untuk mencapai akhbar profesional. Walau bagaimanapun, masih terdapat masalah profesionalisme akhbar, iaitu profesionalisme teknikal, yang sedang ditangani oleh Dewan Pers, dan profesionalisme pragmatik, yang tidak menjadi pemikiran serius bagi Dewan Pers, kerajaan, dan orang ramai. Dalam kajian ini, terdapat peringkat dalam menghuraikan data iaitu melalui pengumpulan artikel kajian, buku, jurnal atau literatur lain yang berkaitan dengan kompetensi wartawan, kebebasan akhbar dan profesionalisme akhbar. Kertas kerja ini menggunakan membincangkan pelaksanaan konsep Tanggungjawab Sosial Akhbar agar wujud tanggungjawab bersama antara wartawan dan orang ramai dalam merealisasikan profesionalisme akhbar.

Kata kunci: *kompetensi wartawan; profesionalisme akhbar; kebebasan akhbar; tanggungjawab sosial*

ABSTRACT

The realization of press professionalism is great hope for the Indonesian press community. The Press Council has formulated many steps and implemented them to improve the quality of journalism, and the quality of journalists as the spearhead of the press. The concept of journalist competence has been applied by targeting 17,000 journalists who take the journalist competency test. The dissemination of journalist competency certification to most journalists and journalistic stakeholders is continuously encouraged so that all journalists are expected to have competency certification to achieve a professional press. However, there are still problems with the professionalism of the press, namely technical professionalism, which the Press Council is addressing, and pragmatic professionalism, which has not become a serious thought for the Press Council, the government, and the public. In this study, there are stages in describing the data, namely through the collection of research articles, books, journals, or other literature related to journalist competence, press freedom, and press professionalism. This paper discusses the implementation of the concept of Social Responsibility of the Press so

that there is a shared responsibility between journalists and the public in realizing press professionalism.

Keywords: *journalist competence; press professionalism; press freedom; social responsibility*

INTRODUCTION

Discussing the competence of journalists, the professionalism of the press, and the social responsibility of the press as if they were looking at the current condition of the Indonesian press as a whole. Since the reformation era in 1998, every person or group is free to establish media or publish it to the public. This situation has brought life changes towards democracy and wide transparency in various areas of government and public life. Thanks to the Press Law Number 40 of 1999, the public sphere has become increasingly open. Freedom of the press seems to be the mantra of the progress of democracy in Indonesia to date.

Since the reformation, the Press Publishing Business License (SIUPP) is no longer valid. Anyone can manage both conventional and online media. Like ear mushrooms, now the number of media in Indonesia is abundant. (Stellarosa & Silaban, 2020) revealed data from the Press Council which stated that until 2017, the media in Indonesia reached 2000 prints. At the same time, cyber media reached 43,300, 1,160 radio media, and 394 television media.

Freedom of media has opened a wide open space for anyone who wants to become a media worker or journalist. In Indonesia, anyone can become a journalist. There are no educational prerequisites or special criteria for journalists as long as they understand the journalistic code of ethics well (Waluyo, 2018). Press Council member Mr. Jomalul Insan in the UKW LKBN Antara briefing on Wednesday (11/3/2021), explained that until 2021 there will be around 40,000 media companies, and of that number, only 1,683 media companies have been verified by the press. Board. Of the tens of thousands of media companies, there are an estimated 200,000 journalists. However, of that number, only around 17,000 have been certified by the Press Council's competence (Beritasatu.com, 2021). A large number of journalists ultimately becomes a problem for the Indonesian press community. It turns out that the majority of the 200 thousand journalists less than 20 percent become real journalists. (Beritasatu.com, 2021) said the rest are half-hearted journalists, where journalists are just a side job, so they are not carried out responsibly. In addition, many also become fake journalists or parasites. This last type of journalist is a virus that destroys the foundations of the press and public trust.

This research focuses on the competence of journalists to realize the professionalism of the press in Indonesia. To maintain the quality of the press, the Press Council issued a regulation requiring all journalists in Indonesia to take the Journalist Competency Test. This rule is contained in the Press Council Regulation Number 1 of 2010, which was later updated through the Press Council Regulation Number 4 of 2017 concerning Journalist Competency Certification (SKW). SKW is a measure of journalist professionalism needed to protect the public interest and public-private rights. This standard also includes the dignity of journalists and does not limit the rights of citizens to become journalists. The competence of journalists is first emphasized on intellectual abilities and general knowledge.

There are six objectives of SKW, namely: 1) Improve the quality and professionalism of journalists; 2) Become a reference for the journalist performance appraisal system by the company; 3) Uphold the freedom of the press based on the public interest; 4) Maintaining the dignity of journalism as a profession that produces intellectual works; 5) Avoiding abuse of the

journalistic profession; 6) Placing journalists in strategic positions in the Indonesian press industry (Maros & Juniar, 2016).

With the implementation of the SKW by Indonesian journalists, can a professional press be realized in Indonesia again? This article doesn't answer that right away. To arrive at that conclusion, we must explore the concept of social responsibility, the Indonesian national press model. Citing the Social Responsibility Theory of the Press, the press is a responsible answer to the Public with apply principles of professionalism. The interests of the community are the estuary of all goals general press. The Press Law Number 40 of 1999, the Journalistic Code of Ethics, and various regulations issued by the Press Council are efforts so that media practitioners can do their profession better.

In this study, we will see that there are still gaps regarding the application of the concept of Social Responsibility of the Press, where the journalists still have difficulty meeting their professional needs. In fact, according to the notion of professionalism, the right and not quite enough answer a journalist must get so that journalists can act professionally in carrying out their work.

JOURNALIST COMPETENCE

Journalists have an important role in maintaining democracy (Costera Meijer & Bijleveld, 2016). As explained (Lacy & Rosenstiel, 2015), journalists can only do quality journalism with free, independent, and pluralistic media. Journalists set competency standards as a measure of professionalism. Standard competence journalists according to (Nourkinan, 2016) should take precedence in guarding trust and fulfilling the public interests, besides guarding the honor of professional journalists.

Field competence journalism covers awareness of ethics, mastery of knowledge, and skills (Agustini, 2019). This competency is important because there are journalists who interpret press freedom solely as freedom without regard to discipline and responsibility, even anarchy or arbitrariness. This kind of behavior is a source of violations of the journalistic code of ethics to violations of the law. According to (Agustini, 2019), journalists carrying out their journalistic activities have an appropriate standard of ability and are accepted by the press community because they can raise the professionalism of journalists that the public wants. So that only those who have the ability that can operate trust press freedom. A journalist is something profession and in operate his profession required doing his job with good as well as obey to code ethics journalism.

Therefore, when this competence is condition absolute for journalists who have an important role in maintaining democracy. (Costera Meijer & Bijleveld, 2016) said that the competence possessed by all journalists makes journalism no longer limited to work, but has been an ideology that can infiltrate everywhere so that the work of journalists remains relevant to people's lives. Journalists must serve the public interest significantly through writing supported by in-depth research. Journalists provide appropriate instruments and information so that people can become good citizens.

Competence journalist has a vital role in maintaining the vitality of democracy. The spirit of democracy depends on the existence of extraordinary journalism. In democracies, newspapers and other forms of supporting journalism and media have long been the “fourth pillar” as an essential element of developing and contemporary democracies around the world

(Flick, 2018). In the United States, the legislature, executive, and judiciary of government include the first three pillars. The fourth pillar is the press, which operates independently.

According to (Mahendra Gautama & Purwanto, 2020), journalist competency standards need to be prioritized in increasing trust and meeting the needs of the community while maintaining the honor of the profession. UNESCO, a world organization in the field of education and culture, places journalistic education as a field that must be the focus of all countries. In the Journalism Education Curriculum Model, UNESCO emphasizes that journalistic education needs to produce journalists with the competencies required by the mass media industry. The following are some of the competencies of journalists according to the UNESCO version: 1) Intellectual abilities and general knowledge; 2) Able to investigate facts and process facts generated through various forms of production, editing, and other content design; 3) Using various journalistic tools and adaptability to technology; 4) Knowledge of journalistic ethics; 5) Knowledge of the role of journalism in society (Mahendra Gautama & Purwanto, 2020).

Meanwhile, (Ritonga, 2019) in Indonesia standard competence is determined by Press Council in the year 2010 through regulation number: 1/Peraturan-DP/II/2010, and is the only level marker to ensure a competent journalist. The Press Council formulates that a journalist who has competence must meet 3 categories, namely: awareness, knowledge, and skills.

Awareness in the formula competence for a journalist is doing her job with realising norms ethics and provisions applicable law to use enhancement performance and professionalism, including in deciding to write or broadcast a problem or event, will always be based on careful consideration. Competence knowledge for journalists means the ability to understand the theory and principles of journalism, knowledge general as well as knowledge special, that includes knowledge general base about various problems like social, cultural, political, legal, historical, as well as economic. Journalists should continue to gather knowledge to be able to follow the dynamics of society in serving useful information. Skills for journalists mean understanding skills in journalism like writing techniques, interviewing, and editing, as well as understanding journalism theory. A journalist also must be capable of doing research, investigation, analysis, and determination of news as well as skilled tool work, including technical information, and have skills coverage (6M) in the form of seeking, obtaining, possessing, storing, processing, and conveying information.

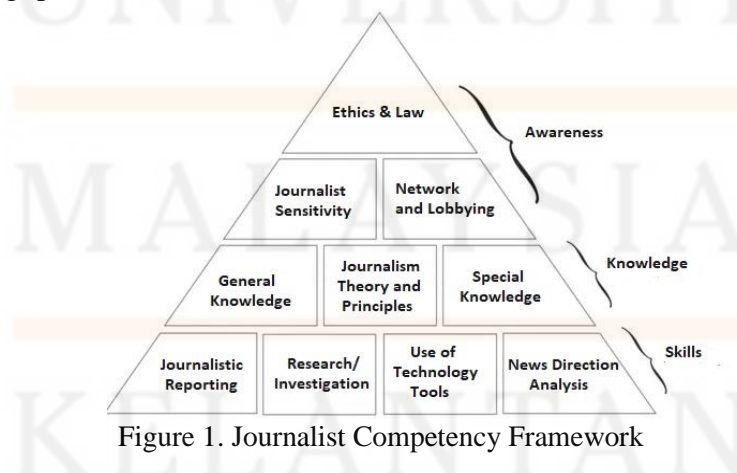

Figure 1. Journalist Competency Framework

In this journalist competency standard, there are three levels of qualification, namely, young journalists, middle journalists, and main journalists. Each level has different key competencies, so the things that are tested are different according to the designation and

position of journalists' career paths in press companies (Priyambodo, 2012). Young Journalists have key competencies in carrying out journalistic activities, in this case, journalists or reporters are in charge. The things that were tested also concentrated on the work of journalists in the field, starting from planning the news, looking for coverage material, face-to-face interviews, door-stop interviews, writing news, editing their news, preparing rubric contents, editorial meetings, and building networks. Intermediate Journalists also have key competencies in managing journalistic activities, in thing this act as editor and coordinator coverage. Things tested include: identifying news reports, analyzing coverage of scheduled events, planning investigative coverage, writing news, and features, editing news, designing rubric content, evaluating coverage results, and also building and maintaining networks and lobbying.

(Priyambodo, 2012) added that Main Journalists focus on evaluating and modifying the process of journalistic activities. Journalist main is the highest level; this is the lead editor, deputy leader editor, and editor executor. They on duty evaluate the coverage plan, determine the appropriate coverage material to be broadcast, direct the investigative coverage, write the editorial, determine the broadcast-worthy coverage material and rubrication policy, and chair editorial meetings. The explanation of the material for the competency test can be seen in the table below:

Journalist Competency Test Material Group			
	Young Journalist	Associate Journalist	Main Journalist
1	Understanding and Implementing the Journalistic Code of Ethics Laws, Laws, and Regulations related to the Press	Understanding and Ensuring the Implementation of the Journalistic Code of Ethics and Laws/Laws/Regulations related to the Press	Policies for the Implementation of the Journalistic Code of Ethics, Laws, Laws, Regulations related to the Press
2	Planning/Proposing coverage	Identifying Coverage (Meeting with Young Journalists)	Facilitating and Building Networks
3	Editorial Meeting with Associate Journalists	Editorial Meeting with Main Journalists	Editorial Meeting with Associate Journalists
4	Looking for Scheduled Event Coverage Materials (Attending Press Conferences)	Writing News/Features	Evaluating the Coverage Plan
5	Intercept Interview (Doorstop)	Building a Network	Determining Broadcastable Coverage Materials
6	Building a Network	Editing News	Rubrication and Editorial Policy
7	Writing News	Planning Investigation Coverage	Directing Investigation Coverage
8	Editing Your Own News	Scheduled Coverage Material Analysis	Writing Header
9	Face-to-Face Interview	Designing Rubric Content	Editorial Meeting (Evaluation)
10	Preparing the Contents of the Rubric	Reporting Evaluation Meeting with Key Journalists	

Figure 2. Journalist Competency Test Material Group

PRESS PROFESSIONALISM

The issue of press freedom is always directly related to the professionalism of the press. In Indonesia, the level of press freedom is still a position not yet exhilarating. In 2022, Indonesia

will be ranked 117 out of 180 countries with a Press Freedom Index score of 49.27. Compared to 2021, the score on down because Indonesia's score in 2021 is 62.60, ranking 113 (Kompas.id, 2022). This is the World Press Freedom Index 2022 ranking by Reporters Without Borders (RSF), which was released Tuesday (3/5/2022). This ranking is measured from several political, legal, economic, social, and security indicators.

Freedom of the press is the freedom of citizens and the national press is not imposed censorship, banning, or banning of broadcasting. However, the demand for a balance between freedom and control of the press is constantly being fought for. Joseph Pulitzer, a reliable US journalist identified that news columns are public property, and editorials are editorial property.

For the sake of the realization of press freedom, every journalist must be able to carry out their roles and functions properly based on professional press freedom. Professional in the sense of obeying Law No. 40 of 1999 on the Press. The realization of press professionalism demands journalists put forward the values of commitment, autonomy, expertise, and responsibility. (Mari, 2015) describes four types of characteristics of professional journalists, namely: 1) Having autonomy, namely being free to control oneself in making judgments and determining the organization; 2) Having a high commitment to public services, not only private economic benefits; 3) Having high skills based on intellectual skills and systematic knowledge; 4) Responsible for fulfilling obligations by implementing a journalistic code of ethics. (Katerynych, 2021) in his journal entitled Professional Competence of Modern Education Journalists, professionalism mentions professionalism as something that has certain material or spiritual values, including social responsibility, professional identity, ethical principles, critical thinking, creativity and innovation, and always trying to improve oneself and development.

(Amin, 2004) also said that a person can be called a professional if he fulfills the following five characteristics: 1) Having certain skills obtained through experience, training, or special education in their field; 2) Receive a good salary, honorarium, or material compensation following the expertise, level of education, or experience gained; 3) All attitudes, behavior, and work activities are protected and influenced by their moral and ethical attachment to the professional code of ethics; 4) Willing to voluntarily join one of the professional organizations according to their expertise; 5) have an extraordinary love and dedication to the chosen field of work in his profession.

From the criteria, one could see that professionalism comes true with the fulfillment of five supporting instruments, in particular point 2, namely accepting salary, honorarium, or compensation enough material by expertise. In this study, professionalism is called professionalism pragmatics, that action a man-rated from its usefulness. who looks at the principal benefit for an individual from a profession as part of a truth (Liljegren, 2012). In context, press professionalism will be difficult to come true if journalists do not get wages or adequate income in accordance standards of their profession.

SOCIAL RESPONSIBILITY OF THE PRESS

Social Responsibility Theory is an evolutionary idea from media practitioners and the work of the Press Freedom Commission, which argues that in addition to informing, entertaining, and generating profit, the press also aims to bring conflict into the arena of discussion (Triyono, 2013). This theory has the premise that freedom and duty go hand in hand. The press is

responsible to the people in carrying out certain essential functions. At the same time, it goes hand in hand with the government.

According to (Obagwu & Idris, 2019), "The press must assume a social responsibility, and if not, someone should see them do it." Once he described the magnitude of the press's social responsibility. (Obagwu & Idris, 2019) states again that the media are controlled by public opinion, consumer action, and professional ethics. However, media responsibility in social responsibility theory is difficult to define because of the complex tug-of-war between the interests of the government and media owners or journalists. Therefore, this system is often said to be on the threshold of the difference between authoritarian and libertarian systems.

Social responsibility theory is widely applied in countries that adhere to a democratic system, one of which is Indonesia. Social responsibility theory assumes that freedom contains the same responsibility. This theory's advantage is that society is also responsible for its freedom. This freedom is expected to minimize rifts in a country, and every individual has the same rights as the government. According to (Bittner, 1989), press freedom in this theory provides an opportunity for the press to criticize the government and its institutions, besides having the primary responsibility of maintaining stability in society. The form of the press's social responsibility is to serve the community with socially responsible reporting as a form of obligation to the community.

The basic principles of Social Responsibility Theory, as summarized by (Patrick U. Ineji et al., 2014), include 1) The press has an obligation and not quite enough answer to the community; 2) There are academic professional standards regarding information, truth, objectivity, and balance; 3) The press is pluralist and gives the public the right to answer; 4) Serve the economic system, for example by bringing together buyers and sellers through advertising media; 5) The press is independent under institutional legal standards; 6) The press avoids tendencies that cause crime, damage, disorder, humiliation, dramatizing ethnic issues and religion.

Restrictions on freedom need to be carried out with considerations: 1) Protecting honor and the good name of the individual; 2) To protect the values that exist in society; 3) Protect law and order; 4) Protect national security; 5) Protecting relationships between countries; 6) Protecting religion, class, ethnicity, and judicial rights against the existence of contempt of court.

This theory states that the press can be used by anyone who has ideas for expression but is prohibited from violating privacy rights or disturbing social structures (McQuail, 2016). It emphasizes press freedom and urges media practitioners to adhere to certain social norms. He opposes media regulation but believes that the press is automatically controlled by public opinion, consumer objections, and professional ethics (Christians & Nordenstreng, 2004).

DISCUSSION

From all the discourses described above, we believe that the Indonesian people who uphold democracy will always maintain the independence and dignity of the press. Media freedom and prestige cannot be separated from professional press discussions. The professional press is born from the quality of journalists in carrying out their daily duties and functions. Qualified journalists will produce good information, which helps the development of Indonesia and improves the quality of Indonesian newspapers (Syafriadi, 2018).

In Indonesia, press freedom is guaranteed as a human right of citizens. Press Law Number 40 of 1999 states that press freedom is a form of people's sovereignty based on democracy, justice, and the rule of law (Article 2). Guarantee press freedom, the national press has the right to seek, obtain and disseminate ideas and information. The press is not subject to censorship, bans, or bans on broadcasting (Article 4). The law strengthens the implementation of the social responsibility theory of the press, which emphasizes that the press is obliged to provide events and opinions by respecting religious norms and the sense of public morality, and the principle of presumption of innocence. The press is obliged to serve the right of reply and the right of correction (Article 5).

Article 6 states that the national press carries out the following roles: 1) Fulfills the public's right to know; 2) Upholding the basic values of democracy, encouraging the realization of the rule of law and human rights, and respecting diversity; 3) Develop public opinion based on precise, accurate, and factual information; 4) Carry out supervision, criticism, correction, and suggestions on matters relating to the public interest; 5) Fight for justice and truth. This is carried out as a form of the press's function of carrying out social control in addition to other functions as a provider of information, carrying out education, providing entertainment news, and being an economic institution (Article 3). The press must act professionally in carrying out their duties and must comply with the journalistic code of ethics.

The issue of press professionalism is divided into two: technical and pragmatic. Technical professionalism is about the technical ability of journalists to become good journalistic professionals. Technical ability here first, problematic at the news level confluence. What is the technical ability of journalists to search and collect? Facts on the ground? To what extent is the element of completeness considered? To what extent have the elements of depth and detail received the attention of journalists?

For this reason, the Press Council requires all journalists to undergo a journalistic competency certification process, which is the starting point for measurable and tested journalistic professionalism improvement. Thus, the Press Council Regulation No. 1 of 2010 was born on journalist competency standards. All journalists in Indonesia must take a competency test to test their technical skills in journalism and be given a journalist competency certificate.

The study of journalist competency standards through journalists' views on the need for certification does not seem well received by press companies and media organizations. Possibly constrained by the costs that must be incurred to take the competency test for journalists who have to pay, or other reasons are not written. Media companies' commitment to requiring journalists to take certification tests is feeble and a dominant factor (Waluyo, 2018).

The problem of professionalism in pragmatic terms is the issue of welfare or material awards given to journalists. Article 10 of the Press Law Number 40 of 1999 states that press companies provide welfare to journalists and press employees through share ownership and distribution of net profits and other forms of welfare.

According to (Hatta, 2017), journalistic welfare refers to a situation where journalists get their economic rights properly. One of the economic rights of journalists is to get a decent wage, in addition to other economic benefits. Referring to Law Number 13 of 2003 concerning Manpower, the concept of welfare includes wages, health insurance, work accident insurance, death insurance, and various benefits. One of the economic benefits that are the main focus is

wages (for journalists who are permanent employees) or honorariums (for journalists who are not permanent employees). Since there is no specific standard for journalists, the minimum wage usually refers to the provincial or city minimum wage, which is set annually in each city/district and province.

The fate of journalists or journalists is not as good as the workload they have to carry. Journalists often report about the welfare or wages of workers and other general workers' wages, but on the other hand, welfare for their people has not been obtained. Journalists have no salary or wage provisions, even the minimum welfare they get from the media companies where they work, which is more or less the same as workers (Hatta, 2017).

As already in the seminar in Bali some time ago, it was said that the welfare level of journalists in Indonesia is the lowest in Asia. Their salary is below IDR 1,000,000 (USD 68) a month. Compared with the salaries of Indonesian journalists, it is only a quarter of the salaries of Thai journalists and one-third of the salaries of Filipino journalists. Many journalists still earn around IDR 500,000 (USD 34) a month (Mutrofin & Abar, 2002).

As has become a saying in the world of work, that salary or salary dramatically affects the level of performance and achievement of journalists. Therefore, the demand for professionalism from the technical side demands an increase in the salary of journalists so that they can fully actualize themselves in journalism, not on how they get extra money for their welfare by violating journalistic ethics. (Liljegren, 2012) says pragmatic professionalism shows that the profession can do better than survive. Some work groups do this a lot.

The problems facing the press lately are not entirely the fault of media practitioners. Many mass media companies have experienced a drop in income by significant. As a result, media companies cannot pay professionals their employees' salaries. One reason for the drops in income because many parties are moving advertisers to current social media platforms loved by society. Even newspaper sales have been around for a long time at the lowest point. While on the same time, journalists have to live and increase demand for journalistic skills. More pathetic again, many journalists have been reduced their salary by company, or fired and not receiving salary again. Many have switched professions to other fields. For those who survive as journalists, they must look for effort side for can live.

In this issue, the author offers a reciprocal model come back contained in the press's social responsibility concept. This reciprocal model is based on the Press Law Number 40 of 1999, article 17, concerning the participation of the public who can carry out activities in developing press freedom and guaranteeing their rights. to obtain the necessary information. This public can look for an ideal concept that does not disturb press freedom.

All of us do not want to see many more idealist journalists who are lost as a result basic demands of their life. They to do violation code ethics blatantly or stealthily. What policies can be taken by Press Council with engagement society, then required research advanced in the future.

METHOD

The methodology used for this paper consists of a library search and evaluation of previous literature reviews on the topic of journalist competence and press professionalism. Library searches range from online and offline materials to journal articles and chapters in a book.

References are based on online databases such as Science Direct, Google Scholar, Web of Science, and Scopus. Further searches were limited to the competence of journalists, professionalism of the press, freedom of the press, and social responsibility of the press. References are only taken from journal articles, book chapters, and full-text documents. Thus, the limitation of this paper could be due to the limited resources of the database, as mentioned earlier. Because the search results also exclude studies of business, politics, and education related to journalist competence and press professionalism. The reference to press professionalism is not limited to the Indonesian press but also considers the progress of the press around the world from 1999, when the reform era began, until now in 2022.

CONCLUSION

The competence of journalists and the professional press has long been a topic of discussion among the press and the public. Previous research has proven that competent journalists strengthen their professional behavior, especially technical professionalism. On the other hand, the question of pragmatism professionalism has not been answered, so the issue of journalistic professionalism seems to be endless. The relationship between the theory of social responsibility of the press which is associated with the Press Law Number 40 of 1999, specifically Article 17 concerning the role as well as the public in guarding quality national press can be used in draft news as a solution. This research at least provides an overview of the novelty of research on the concept of journalistic competence and press professionalism based on a gap analysis of the existing research.

REFERENCES

- Agustini. (2019). Kompetensi kesadaran etika dan hukum pada wartawan televisi dalam menjaga objektivitas berita. *Jurnal Sosial Humaniora*, 10, 128–137.
- Amin, T. Al. (2004). Sistem Pers Indonesia. *Elearning.Iainkediri.Ac.Id*, 1–13. http://elearning.iainkediri.ac.id/pluginfile.php/196352/mod_resource/content/1/Sistem_Pers_Indonesia.pdf.
- Beritasatu.com. (2021, November 4). *Baru 17.000 wartawan di Indonesia tersertifikasi Dewan Pers*. <https://www.beritasatu.com/news/849399/baru-17000-wartawan-di-indonesia-tersertifikasi-dewan-pers>.
- Christians, C., & Nordenstreng, K. (2004). Social responsibility worldwide. *Journal of Mass Media Ethics*, 19(1), 3–28. https://doi.org/10.1207/s15327728jmme1901_2
- Costera Meijer, I., & Bijleveld, H. P. (2016). Valuable Journalism: Measuring news quality from a user's perspective. *Journalism Studies*, 17(7), 827–839. <https://doi.org/10.1080/1461670X.2016.1175963>.
- Flick, D. (2018). Combatting fake news: alternatives to limiting social media misinformation and rehabilitating quality journalism. *Science and Technology Law Review*, 20(2).
- Hatta, F. M. (2017). Paradoks Kesejahteraan Wartawan Studi Pada Wartawan di Bandung. In J. R. Suminar (Ed.), *PROSIDING SEMINAR NASIONAL MAGISTER COMMUNICATION* (pp. 120–130). Pascasarjana Ilmu Komunikasi Universitas Padjadjaran. <https://core.ac.uk/download/pdf/345243156.pdf>.
- Katerynych, P. (2021). Professional Competencies of a Modern Education Journalist. *Media Education (Mediaobrazovanie)*, 17(1), 267–276. <https://doi.org/10.13187/me.2021.2.267>.
- Kompas.id. (2022, May 3). *Kebebasan pers di Indonesia melemah*. <https://www.kompas.id/baca/dikbud/2022/05/03/kebebasan-pers-di-indonesia-melemah>.

- Lacy, S., & Rosenstiel, T. (2015). Defining and Measuring Quality Journalism. *Media the Public Interest Initiative*, 1–66.
- Liljegren, A. (2012). Pragmatic professionalism: micro-level discourse in social work. *European Journal of Social Work*, 15(3), 295–312. <https://doi.org/10.1080/13691457.2010.543888>.
- Mahendra Gautama, I. D. G. A., & Purwanto, I. W. N. (2020). Pengaturan Pembatasan Kebebasan Pers Dalam Penyebaran Informasi Di Indonesia. *Kertha Semaya : Journal Ilmu Hukum*, 8(10), 1618. <https://doi.org/10.24843/ks.2020.v08.i10.p12>.
- Mari, W. (2015). An enduring ethos: Journalism textbooks and public service. *Journalism Practice*, 9(5), 687–703. <https://doi.org/10.1080/17512786.2014.972078>.
- Maros, H., & Juniar, S. (2016). *Merawat Kemerdekaan Pers dengan Objektivitas*. 1–23.
- McQuail, D. (2016). Media Performance. *The International Encyclopedia of Political Communication*, 1–9. <https://doi.org/10.1002/9781118541555.wbiepc095>.
- Mutrofin, & Abar, A. Z. (2002). *Kemerdekaan dan profesionalisme pers di Indonesia*.
- Nourkinan. (2016). Analisis pengaruh kompensasi dan kompetensi terhadap kinerja wartawan media cetak. *Jurnal Politikom Indonesiana*, 1(1), 20–36.
- Obagwu, P. U., & Idris, K. M. (2019). Social Responsibility Theory of the Press: A Critique of Its Application and Constraints. *International Journal of Innovative Research and Development*, 8(12), 26–35. <https://doi.org/10.24940/ijird/2019/v8/i12/dec19010>.
- Patrick U. Ineji, P. ., Nkanu, E. A., & Okoi, P. E. (2014). Social Responsibility Media Theory And Its Implication For Media Professionalism In Nigeria. *Journal of Media, Communication & Languages. AN*, 242–255.
- Priyambodo. (2012). *Pedoman Uji Kompetensi Wartawan*. Lembaga Pers Dr Soetomo.
- Ritonga, R. (2019). *Triple helix sumber daya wartawan Indonesia yang terdidik dan kompeten*.
- Stellarosa, Y., & Silaban, M. W. (2020). Perempuan, Media dan Profesi Jurnalis. *Jurnal Ilmu Komunikasi*, 16(3), 283. <https://doi.org/10.31315/jik.v16i3.3209>.
- Syafriadi. (2018). *Hukum Pers Dalam Ketatanegaraan Indonesia*. Suluh Media.
- Triyono, D. A. (2013). The Four Press Media Theories: Authoritarianism Media Theory, Libertarianism Media Theory, Social Responsibility Media Theory, and Totalitarian Media Theory. *Jurnal Pengembangan Humaniora*, 13(3), 194–201.
- Waluyo, D. (2018). Tinjauan Standar Kompetensi Wartawan untuk Meningkatkan Kapasitas Media dan Profesionalisme. *Jurnal Studi Komunikasi Dan Media*, 22(2), 167. <https://doi.org/10.31445/jskm.2018.220206>.

Guinea Absolute Monarchy Leaderships Nuclear Security Weapon Nations

Cheick Ahmed Mandian Toure

*Department of Histories / Civilizations, Faculty of Language Studies and Human
Development, University Malaysia Kelantan (UMK)*
cheicktoure33@gmail.com

Marwan Ismail

*Department of Histories / Civilizations, Faculty of Language Studies and Human
Development, University Malaysia Kelantan (UMK)*
marwan@umk.edu.my

Ali Salman

*Department of Histories / Civilizations, Faculty of Language Studies and Human
Development, University Malaysia Kelantan (UMK)*
ali.salman@umk.edu.my

ABSTRACT

Malinké ethnic chiefs in Guinea Absolute monarchy Meaning The specific choice of the coast of Upper Guinea was due to the orientation of my technical skills as a historian. The goal is 3 Threes. (A. First) However, the successful transition was seen as proof of Guinean society's commitment to peace & Security (B. Second) financial crisis with Guinea from Transitional Republic to Nation Malinké of the Absolute Monarchy of Guinea established. (C.Third) times according to the political, social and economic conditions the body of citizens politically acceptable to the public Nuclear energy is. A major constraint is the economics of nuclear energy. Therefore, the research methods used to analyze qualitative data. qualitative content analysis such as credibility. Therefore, the results mean that the data accurately represents the information provided. Primary qualitative research focused on academic journals. Research Study of Reviewed journal, Articles and Book This qualitative achieved and journal articles And news paper. Finding a) However, political and military leaders should understand that with Guinea Absolute Monarchy Nuclear Security Russia Finding (b) the assumption that, in practice, the CSTO contributes to improving the security of the Federation. Research finding (C) communication systems, environmental protection, political, economic and security integration structures within the United Nations Security Council of the Russian Federation. & Guinea States Absolute Monarchy . Conclusion studies the authorities of this state could Rules in governing the monarch

Keywords: *Guinea Absolute Monarchy Military powe Collective Security Treaty Organization (CSTO)*

INTRODUCTION

According to David Lai (2011) Argued that as Ethnic malinke leaders in Guinea Absolue Monarchy and China continues to modernize its military power, the balance of power over the Taiwan Strait will change Currently, the US policy of measured arms sales to Taiwan is a point of contention repeated between China and the United States. However, political and military leaders should understand that with China and Russia standing in the way, a military solution to the North Korea problem is not an option. Conclusion showing this Ph.D. Some international security experts say the deepest began an apparent power transition between the two nations, the United States and China have seen many changes in their relationship over the past 30 years. For Example Walter Anthony Rodney (1966) The specific choice of the Upper Guinea

coast was due to the direction of my technical skills as a historian, a discovery by the Portuguese in the 15th and 16th centuries gave a distinct geographical flavor to the surviving records of Portuguese activity in Africa at that time. however the southern part of the coast of Upper Guinea was subjected to the invasions of the Africans who were Manes This is the starting point for the study of external forces. However from the West African coast between Gambia and Cape Mount, It seeks to reconstruct an image of this society in the middle of the 16th century, to be geographically and ethnically a single entity, According To Walter Rodney & Richard Gray(2008) Absolute monarchy in Guinea, with a dominant Mande presence; the growing population of the Gold Coast, improving technology and the spread of specialization.

GUINEA TRANSITION TO MALINKE POLITICS ABSOLUTE MONARCHY.

According To Ana Larcher Carvalho (2011) Finding Thats. the socialist administration of Sékou Touré 1958-1984 and the liberal regime of Lansana Conté 1984-2008. Since its independence from France in 1958, Guinea has remained relatively stable and has never experienced violent conflict. Until the bloodless military coup of 2008. However, the successful transition was seen as evidence of Guinean society's commitment to peace. Security Absolute monarchy Malinké ethnic leaders In Guinea, although it is a country rich in resources, it is undergoing a deep economic and financial crisis. Guinea from Transition Republic To established Guinea Absolute Monarchy Malinke Nation.

Internet Source Table 1.2.1



According To Ernest Mensah Akuamoah(2021) Finding growing political instability coupled with growing corruption and economic hardship, the stage was set for a potential military takeover. However, African leaders have taken a different approach to entrenching themselves in power. the African continent at least not in West Africa. Therefore, their term limits or age limits are prescribed by the Constitution. showing this Ph.D Finding that .This phenomenon has been called a constitutional coup.

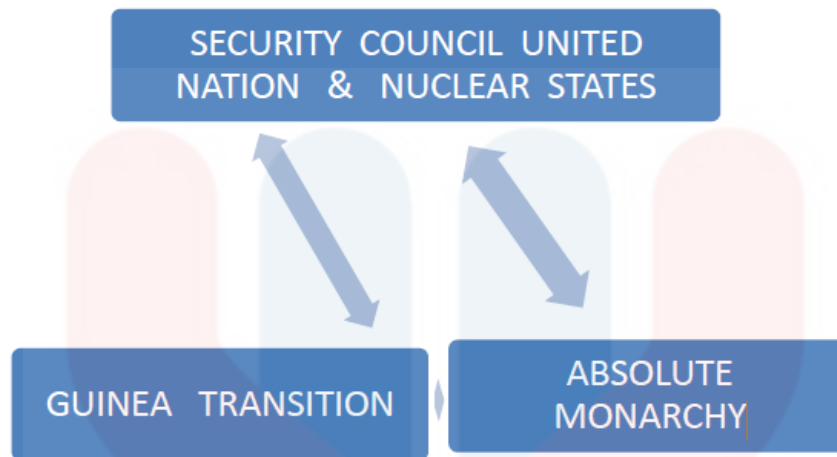

By Mairi Stewart MacDonald (2009) Finding By behaving as if its sovereignty were absolute after the September 28 Referendum and the October 2 Declaration of the Republic, Guinea was able to make independence a reality, as a means of safeguarding sovereignty and the compromises that its institutional form. both in the economic and political potential of the West African state, a government of African actor Sékou Touré in Guinea, the result of Guinea's foreign relations could appear as a dependency

ABSOLUTE MONARCHY SECURITY

According To Julian Swann(2005) However, the desire to protect their privileges and extend their authority had the organization, composition and powers of the states and explores their administration, their power struggles with rival institutions and their relationship to the crown a study of the history of the States General the classic period of absolute monarchy. Although it is not a representative institution in the modern sense.

Figure 1.3.1



For Example by Krzysztof Trzcinski(2007) Argued that, the citizen a concept that has influenced all historical models of citizenship since – which is the basis of the citizen understood as a political animal. However, the concept of "citizen" has been redefined many

times depending on political, social and economic conditions the body of citizens have also differed. the authorities of that state and could participate in governing the monarch in an absolute monarchy historical patterns containing the so-called “citizenship traits” of a person’s status in the state,

RESEARCH METHODOLOGY AND LAWS

Primary Qualitative research focused on academic Journal .media Nwes conduct includes Researchy Qaultative Research methods Secondary Data Methods showing that Secondary data Study of Reviewed journal ,Articles and Book This qualitative achived and journal articles And news paper According To Ernest Mensah Akuamoah(2021) it is therefore not surprising that the ousting of Condé by his special forces led by Colonel Mamady Doumbouya has found favor with the majority of Guineans, whose citizens they believe will accept a change in leadership. can sometimes take longer to happen, or will never happen. According To M.V. Ramana(2009)Argued that. the development of new reactor designs, the disposal of nuclear waste that is technically feasible and politically acceptable to the public. Nuclear energy is. A major constraint is the economics of nuclear power, driven both by high capital costs and financial uncertainties. Study by Malina Kaszuba(2019) the assumption that, in practice, the CSTO contributes to the improvement of the Federation's security The common economic space, the European and Eurasian market, customs policy, the development of transport and communication systems, environmental protection, political, economic and security integration structures within the post-Soviet region of the Russian Federation, his authorities were convinced that the leadership. According To Satu Elo & Maria Kääriäinen ,And Outi Kanste3 , Tarja Pölkki1 And Kati Utriainen & Helvi Kyngäs(2014) Qualitative content analysis is commonly used to analyze qualitative data. qualitative content analysis is often presented using terms such as credibility, reliability, conformability, transferability and authenticity the quality of the results of qualitative content analysis The conformability of the results means that the data accurately represent the information provided explanation of how the concepts Nuclear State Nations.

Figures 1.4.2.



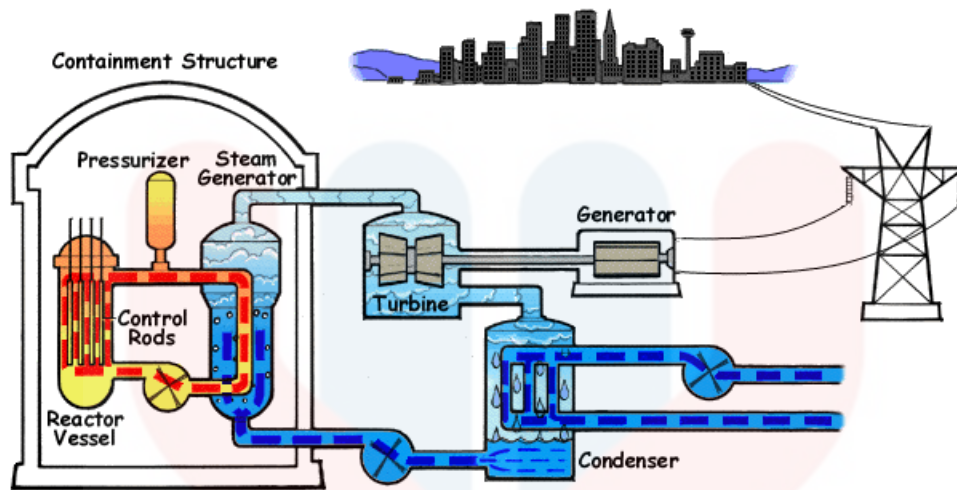

Studie by Mohajan, Haradhan (2018) Argued that qualitative research has been increased in many institutions. It can be used to explore several areas of human behavior for the development of organizations. Find showing That's .However qualitative research methodology to discuss several aspects of research for improving the competence of readers. experiences, meanings and relationships, and logs of social processes. According To Wafaa Abdullah Alamri(2019) The qualitative research method was opted after extensive literature. Examining the information in a diary helps people to judge their behavior towards others in the face of certain events. using a qualitative research design. Qualitative research focused on academic conduct includes information in a real-life scenario, new to the event, this Ph.D.

CONCLUSION OF FINDING METHODS

Guinea from Transition Republic To established Guinea Absolute Monarchy Security Council to protect their privileges and extend their authority had the organization composition and powers of states Malinke ethnic nation in Guinea . Eurasian market, customs policy, the development of transport and communication systems, environmental protection, political, the development of new reactor designs, the disposal of nuclear waste technically feasible and politically acceptable to the public. However, the success of the transition was seen as proof of Guinean society's commitment to peace. Security African leaders have taken a different approach to entrenching themselves in power. the African continent at least not in West Africa. of the results of the qualitative content analysis The conformability of the results safeguarding sovereignty and the compromises that its institutional form.

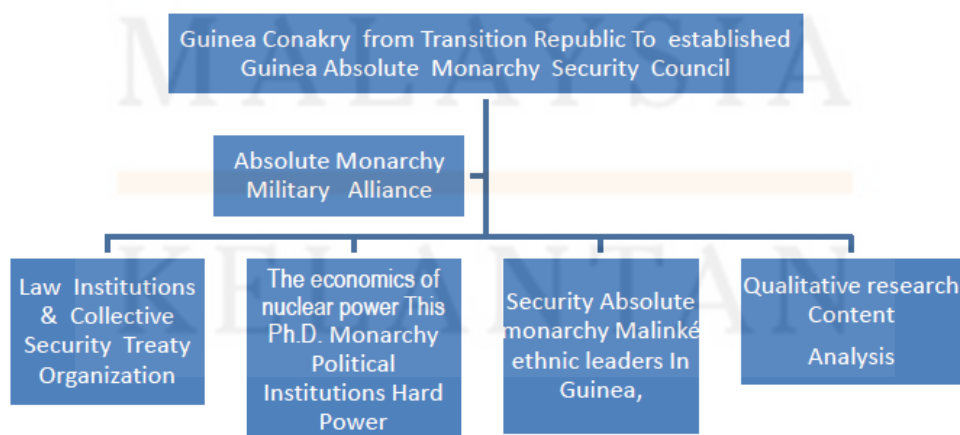



REFERENCE

- Ana Larcher .C (2011) Republic of Guinea: an analysis of current drivers of change, NORWEGIAN PEACEBUILDING CENTRE Noref Working Paper.
- David .L (2011) Strategic Studies Institute Book THE UNITED STATES AND CHINA IN POWER TRANSITION. Director, Strategic Studies Institute, U.S. Army War College, 632 Wright Ave, Carlisle, PA 17013-5046. P1-
- Ernest Mensah .A (2021) Australian Institute of International Affairs,2021 in Review: The Coup in Guinea: Causes and Consequences.
- Helvi. K .(2014) Qualitative Content Analysis: A Focus on Trustworthiness SAGE Open January-March 2014: 1–10 2014 DOI: 10.1177/2158244014522633 sgo.sagepub.co, P1-3-4 5.
- Julian .S (2005)Provincial Power and Absolute Monarchy: The Estates General of Burgundy, 1661–1790. Birkbeck, University of London,DOI:10.1017/CBO9780511496646
- Krzysztof .T (2007) A Reversal of Perspective: The Subject as Citizen under Absolute Monarchy, or the Ambiguity of Notions, Jagiellonian University,
- Mairi Stewart . M (2009) THE CHALLENGE OF GUINEAN INDEPENDENCE, 1958-1971, he requirements for the degree of Doctor of Philosophy Graduate Department of History University of Toronto. P1-4-9
- M.V. R (2009) Nuclear Power: Economic, Safety, Health, and Environmental Issues of Near-Term Technologies,DOI:10.1146/annurev.environ.033108.092057. University of British Columbia - Vancouver.
- Mohajan, Haradhan (2018)Qualitative Research Methodology in Social Sciences and Related Subjects ,Premier University, Chittagong, Bangladesh. Journal of Economic Development, Environment and People, Vol-7, Issue 01, 2018,
- Malina .K . (2019) The Collective Security Treaty Organization (CSTO) in the foreign policy of the Russian Federation.The Copernicus Journal of Political Studies DOI:10.12775/CJPS.2019.008. Siedlce University of Natural Sciences and Humanities
- Satu Elo & Maria Kääriäinen ,And Outi Kanste3 , Tarja Pölkki1 And Kati Utriainen & Wafaa Abdullah. A (2019) Effectiveness of Qualitative Research Methods: Interviews and Diaries,Correspondence:
- Wafaa Abdullah Alamri, Lecturer at English Language Institute, University of Jeddah, Saudi Arabia. Received: Online Published: May 28, 2019 doi:10.11114/ijecs.v2i1.4302 URL: <https://doi.org/10.11114/ijecs.v2i1.4302>.
- Walter Anthony. R (1966)A History of the Upper Guinea Coast 1545-1800, Thesis presented for the Degree of Doctor of Philosophy? at the University of London. ProQuest

11015595 Published by ProQuest LLC(2018). Copyright of the Dissertation is held by the Autho. P3-
Walter Rodney & R .G (2008)The Guinea coast Published online by Cambridge University Press:



UNIVERSITI

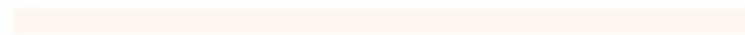

MALAYSIA

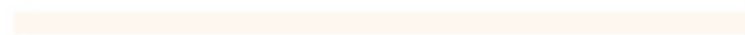

KELANTAN

The Application of Fuzzy Delphi Method in Validating Refined YouTube Evaluation Rubric

Foo Mei Ting
Universiti Malaysia Kelantan
meiting.e19e005p@siswa.umk.edu.my

Siew Foen Ng
Universiti Malaysia Kelantan
siewfoen@umk.edu.my

ABSTRACT

This study aimed to develop a guideline for preschoolers educational YouTube videos selection. Design and Development Research (DDR) methodology was applied in developing the guideline. There are 3 phases in DDR which are analysis phase, the design and development phase, and the evaluation phase. This article focused on the design and development phase in which experts in pedagogy and preschool education were appointed as panel to validate the rubric. Data were analyzed using the Triangular Fuzzy Number and Defuzzification Process. The first round of FDM indicated that out of 24 items only 22 were accepted. This indicated, some of the items needed to be revised and Gagne's Nine Steps of Instructional in the initial rubric construction was not suitable. The experts echoed similar concern that this theory was not suitable to be used as video evaluation steps. As a result, the theory Brame (2016) on effective educational video elements that consist of cognitive load, student engagement and active learning was used instead. The revised rubric went through the second round of FDM and subsequently all the items were accepted. The results confirmed the content validation of this phase as it involved verification from experts in the field of preschool pedagogy. The findings from the design and development phase enable the continuation to the next phase which is to test the effectiveness of the rubric.

Keywords: *Fuzzy Delphi Method; YouTube videos; Preschoolers; Guidelines; Validating*

INTRODUCTION

This research was applied with Design and Development Research (DDR) methodology to develop a guideline for parents and teachers to select educational YouTube videos for preschoolers. The DDR consists of three phases which are analysis phase, the design and development phase, and the evaluation phase. YouTube evaluation rubric by Neumann and Herodotou (2020) was adapted to develop the guideline. Neumann and Herodotou (2020) conducted the analysis phase. Since the validation of the guideline was not done, this research carried out the design and development phase to validate the YouTube evaluation rubric. As recommended by the authors, validation of the rubric needs to be carried out with a group of experts. Hence, this paper focuses on discussing the process of using the Fuzzy Delphi Method (FDM) to validate the refined YouTube evaluation rubric intended to evaluate educational YouTube videos for preschoolers. The process was carried out in two rounds to get the consensus from all the experts. The initial refined YouTube evaluation rubric was based on Gagne's nine instructional theory, however according to preschool pedagogy experts the theory is not suitable to be applied in the rubric as evaluation steps. Subsequently three elements which are cognitive load, student engagement and active learning for effective educational videos proposed by Brame (2016) were used to support the rubric construction.

Validation of the rubric is required to ensure the rubric measures what it is supposed to measure. Validity can be classified into construct validity, content validity, face validity and criterion validity. Measuring the instrument's content validity is crucial since it inspires confidence in readers and researchers (Yaghmale, 2003). According to Heale and Twycross (2015), face validity is a subcategory of content validity. Content validity distinguishes itself through 4 main steps, first the purpose of the test is defined, then the content domain based on relevant standards, skills or tasks will be defined. Next, the content domain will be used to create a blueprint for the test and finally experts will evaluate the blueprint. To establish the content validity of the refined YouTube evaluation rubric, Fuzzy Delphi method was used to get consensus from the experts.

FUZZY DELPHI METHOD

In 1985, Murray, Pipino and Gigch introduced The Fuzzy Delphi method which is a method modified from the Delphi technique. It is a combination of Fuzzy Set Theory and the Delphi Method. FDM is a systematic method that consists of steps that need to be followed to get expert consensus. It is a time and cost- saving method for each questionnaire to be validated as it can reduce the number of rounds of surveys and experts are able to fully convey their point of view to ensure flawlessness and provide consistent opinions. This method is able to convey the original opinion of the experts without misinterpreting it.

PURPOSE OF STUDY

This research was carried out to provide a guideline for parents and teacher to select educational YouTube videos for preschoolers. The refined YouTube evaluation rubric was developed by applying Design and Development Research (DDR) that consist of 3 phase namely need analysis phase, design and development phase, and evaluation phase. The YouTube evaluation rubric was adapted from Neumann et al. (2020), they looked at the studies describing how specific screen media design elements may enhance children's learning, and created a set of evaluation standards that may be used to help parents choose YouTube videos for their kids. Hence, the need analysis phase was conducted by the authors, as from the literature review YouTube has published instructions on how to tell if a kid video is generic and open to several interpretations: educational content, child actors or models or characters and toys that appeal to children are included in the video, the language should be suitable for children, and the video presents activities for children. In design and development phase, the YouTube evaluation rubric was refined based on literature review grounded by theories and past researches. Then Fuzzy Delphi Method was applied to validate the refined YouTube evaluation rubric. For the evaluation phase, quasi-experiment will be carried out. This article focuses on the process of validating the refined YouTube Evaluation rubric by pedagogy and preschool education experts through the Fuzzy Delphi method (FDM).

RESEARCH OBJECTIVE

To validate the refined YouTube evaluation rubric by pedagogy and preschool education experts through the Fuzzy Delphi method (FDM).

RESEARCH QUESTION

According to pedagogy and preschool education experts, does the refined YouTube evaluation rubric valid to evaluate educational YouTube videos for preschoolers?

METHOD

The refined YouTube evaluation rubric was adopted from Neumann et al. (2020) YouTube evaluation rubric that has been developed to evaluate the quality of YouTube videos. Although a pilot study was carried out by Neumann et al. (2020) it was suggested that the rubric needed to be validated by experts. Hence, after the rubric was refined, Fuzzy Delphi was carried out to validate the refined YouTube evaluation rubric.

The outbreak of the global COVID19 pandemic and efforts to contain it through public health measures, social distancing, lockdown and quarantine measures has deterred the data collection process to proceed, subsequently the researcher has sought to online data collection instead of face to face. According to Duffy (2002) web-based data collection is capable of producing higher-quality data due to automatic skipping and branching logic, as well as warning messages in the event of missing or improbable replies. Hence, data collection was carried out using the online platform and the correspondents were done using email. Google form link were sent to all the experts to enable them to validate the items in the refined YouTube evaluation rubric. The experts were encouraged to express their professional opinions freely for each of the items in the rubric.

Table 1. Overview of Fuzzy Delphi Method in validating the Refined YouTube Evaluation Rubric

Purpose	Method	Expectation of the outcome	Respondent
To validate the refine YouTube evaluation rubric by experts in the pedagogy and preschool education.	Fuzzy Delphi (First round- initial questionnaire) (Second round- revised questionnaire)	Refined YouTube evaluation rubric is validated to evaluate educational YouTube videos	12 experts

Step 1: Expert panel selection

Based on Jones and Twiss (1978) the number of experts for Fuzzy Delphi method should be 10 to 50 people. 12 experts were purposely selected, based on the criteria set to be met, the experts must possess the knowledge about pedagogy or early childhood education and experience in teaching for at least 5 years to validate the refined YouTube evaluation rubric. The panels were teachers and lecturers who have been in education line for more than 10 years, and are specialized in pre-school and pedagogy. They were randomly selected from teacher training colleges in Malaysia and pre-schools in Kelantan, Perak and Kuala Lumpur.

Table 2. Fields of experts in details

Field of expert	No. of experts
Lecturer in Early Childhood education and pedagogy, expert in psychology, consultant of Taska Seri Mawar, Early Childhood education module writer,	1

subject matter expert – early childhood education, main trainer for PERMATA, National Standard Curriculum for early childhood education	
Lecturer specialize in pedagogy, education psychology, educational knowledge, emotional intelligence and book author of learning skills also of Head of Educational Science department	1
Lecturer with the expert in educational knowledge, children development, teaching and learning module development, classroom evaluation module development, new pedagogy deep learning concept and motivation with a PhD degree and also the Head of Educational Science Unit	1
Lecturer with PhD degree, Head of Early childhood development Unit, expert in early childhood education, preschool and writer of National Preschool Curriculum	1
Directors of kindergarten	2
Preschool teacher with master’s degree in early childhood education, head of coach for preschool English language teaching and also one of the coach for preschool education in district	1
Preschool teacher that represent Kelantan to the National preschool pedagogy innovation and won the first prize for the national level	1
Preschool teacher with master’s degree and also the coach teacher of Teaching Preschool Chinese Language in Kelantan.	1
Preschool this teacher owns a master’s degree in early childhood education and active in participating international teaching and learning pedagogy training and workshop	1
Preschool teacher which was the head of the zone and won the teaching and learning competition for district level	1
Preschool teacher who won the excellent teaching award twice.	1

Table 3. Work Experience of the Fuzzy Delphi experts

Year	Frequency
3-5 years	0
6-10 years	0
11-15 years	2
15 years and above	10

Table 4. Occupation of the Fuzzy Delphi experts

Occupation	Frequency
Experience teacher (> 5 years teaching experience)	8
Teacher training college lecturer	4

Table 5. Field of expertise of Fuzzy Delphi experts

Field	Frequency
Preschool	9
Pedagogy	3

Step 2: Determining linguistic scale

The expert panels were given a Delphi instrument which is a set of questionnaire with 5 Likert scale to validate the refined YouTube evaluation rubric.

Table 6. The listing of the suggested suitable elements under each criterion was organized using a ranking scale as:

Level of expert agreement	5	4	3	2	1
	Highly agree	Agree	Neither agree nor disagree	Disagree	Strongly disagree

Step 3: Determining the Threshold ‘d’ value

The Threshold ‘d’ value plays an important role in determining the level of agreement among experts’ panel on the items in the rubric. The data obtained were entered onto a Microsoft Excel worksheet proposed by Ramlie et al. (2014), Mohd Jamil et al. (2017) and Mohd Jamil and Mat Noh (2020). Mustapha and Darussalam (2018) explained that if the ‘d’ value which is the value of threshold is lower or equivalent to 0.2 (≤ 0.2) it can be consider that the item has achieved the consensus of the experts’ panel. The formula used is shown as below:

$$d(\bar{m}, \bar{n}) = \sqrt{\frac{1}{3} [(m1 - n1)^2 + (m2 - n2)^2 + (m3 - n3)^2]}$$

Step 4: Determining group consensus percentage

From the Microsoft Excel calculation, value of the percent agreement of expert panel must be equal to or more than 75% in order to proceed to the next process. If the expert panel consensus is less than 75% it means the items need to be removed or the process need to be carry out again.

Step 5: Determining the α -cut value / defuzzification value

α -cut value / defuzzification value is used to rank and eliminate the items that have lower or greater than 0.5 α -cut value / defuzzification value. The α -cut value was calculated using the formula below:

$$A_{\max} = \frac{1}{4} * (a_1 + 2a_m + a_2)$$

RESULTS

The Fuzzy Delphi method (FDM) was carried out in two rounds to obtain experts’ consensus to validate the refined YouTube evaluation rubric. The FDM first round result showed that the experts disagreed with some of the items and the theories used. Recommendations were given and amendments were made to improve the rubrics. Gagne nine steps of instructional model is rejected by experts as it will be more suitable to be applied in teaching and learning process when interaction occurs between teacher and students. Brame (2016) effective educational videos consist of three elements which are cognitive load, students engagement and active learning were applied and recommended amendments were made. Subsequently the second round of FDM was carried out and thus resulted all the items and theories applied accepted by all the experts.

Round 1 FDM

The Gagne nine steps of the instructional model was applied in the refined YouTube evaluation rubric. The nine steps include gain attention, inform learners of objectives, stimulate recall of

prior learning, present the content, provide ‘learning guidance’, elicit performance (practice), provide feedback, assess performance, enhance retention and transfer the job. The first round of Fuzzy Delphi required experts to validate 24 items in the rubric using the 1-5 Likert-scale (1= strongly disagree, 5= strongly agree).

Table 7. Refined YouTube evaluation rubric- Gagne’s Nine steps of instruction model

No.	Criteria	0 No	1 Yes	Comment
1. Gain attention				
1	Does the video gain attention of viewers?			
2	Does the video retain attention of viewers?			
3	Does the video keeps viewers motivated throughout?			
2. Inform learners of objectives				
4	Does the learning objective stated in the beginning of the video?			
5	Are learning elements highlighted in the video?			
3. Stimulate recall of prior learning				
6	Does the video consider learners’ prior knowledge?			
7	Does the content share similarities with the child (e.g. age, gender, interests)?			
4. Present the content				
8	Is each scene clear, logical, and easy to follow?			
9	Is the size of the video clip suitable for children?			
10	Does the duration/ length of the video suitable for viewers?			
5. Provide ‘learning guidance’				
11	Are pictures/ graphic/ animations presented alongside words/ narration?			
12	Is conversation style used in wording (oral and written)? E.g. passive, aggressive, passive-aggressive, and assertive.			
13	Are social relationship accurately represented (e.g. gender and cultural stereotypes, power relationship)?			
6. Elicit performance (practice)				
14	Does the video encourage children to repeat the content?			
15	Can the child imitate the content presented (e.g. repeat a song, make body movements or gesture)?			
16	Are the images, audio, sounds and language used appropriately for children (i.e. the children can understand the content)?			
7. Provide feedback				
17	Is some content repeated during the video (e.g. to reinforce learning in positive ways)?			
18	Does the on-screen behaviour receive appropriate reinforcement (e.g. positive behaviour is praised or encouraged and negative behaviour is discourages)?			

Table 8. Result for the round 1 Fuzzy Delphi

8. Assess performance					
19	Does the video support cognitive development (e.g., language, literacy)?				
20	Does the video support physical development (e.g., gross and fine motor skills)?				
21	Does the video support socio-emotional development (e.g., foster positive relationships, communication skills, moral attitudes, resilience, self-regulation, self-confidence)?				
9. Enhance retention and transfer to the job					
22	Does the video encourage children to perform creative tasks?				
23	Does the video encourage children to solve problems?				
24	Does the video encourage children to provide alternative ideas or ways of doing things?				
No.	Steps Item	Triangular Fuzzy Numbers		Defuzzi fication Process	Outcome
		Thres hold (d)	Experts consens us (%)	Fuzzy (A)	
Gain attention					
1	Does the video gain attention of viewers?	0.153	50.0%	0.600	Reject
2	Does the video retain attention of viewers?	0.204	75.0%	0.550	Accept
3	Does the video keeps viewers motivated throughout?	0.204	75.0%	0.550	Accept
Inform learners of objectives					
4	Does the learning objective stated in the beginning of the video?	0.204	75.00%	0.550	Accept
5	Are learning elements highlighted in the video?	0.242	66.67%	0.550	Reject
Stimulate recall of prior learning					
6	Does the video consider learners' prior knowledge?	0.204	41.67%	0.600	Reject
7	Does the content share similarities with the child (e.g. age, gender, interests)?	0.204	41.67%	0.600	Reject
Present the content					
8	Is each scene clear, logical, and easy to follow?	0.127	91.67%	0.567	Accept
9	Is the size of the video clip suitable for children?	0.255	66.67%	0.467	Reject
10	Does the duration/ length of the video suitable for viewers?	0.191	83.33%	0.550	Accept
Provide 'learning guidance'					

11	Are pictures/ graphic/ animations presented alongside words/ narration?	0.127	91.67%	0.633	Accept
12	Is conversation style used in wording (oral and written)? E.g. passive, aggressive, passive-aggressive, and assertive.	0.170	91.67%	0.533	Accept
13	Are social relationship accurately represented (e.g. gender and cultural stereotypes, power relationship)?	0.204	75.00%	0.550	Accept
Elicit performance (practice)					
14	Does the video encourage children to repeat the content?	0.187	75.00%	0.583	Accept
15	Can the child imitate the content presented (e.g. repeat a song, make body movements or gesture)?	0.153	50.00%	0.600	Reject
16	Are the images, audio, sounds and language used appropriately for children (i.e. the children can understand the content)?	0.140	83.33%	0.617	Accept
Provide feedback					
17	Is some content repeated during the video (e.g. to reinforce learning in positive ways)?	0.187	75.00%	0.583	Accept
18	Does the on-screen behaviour receive appropriate reinforcement (e.g. positive behaviour is praised or encouraged and negative behaviour is discourages)?	0.153	50.00%	0.600	Reject
Assess performance					
19	Does the video support cognitive development (e.g., language, literacy)?	0.204	75.00%	0.550	Accept
20	Does the video support physical development (e.g., gross and fine motor skills)?	0.221	66.67%	0.567	Reject
21	Does the video support socio-emotional development (e.g., foster positive relationships, communication skills, moral attitudes, resilience, self-regulation, self-confidence)?	0.153	50.00%	0.600	Reject
Enhance retention and transfer to the job					

22	Does the video encourage children to perform creative tasks?	0.216	66.67%	0.550	Reject
23	Does the video encourage children to solve problems?	0.187	83.33%	0.533	Accept
24	Does the video encourage children to provide alternative ideas or ways of doing things?	0.221	75.00%	0.517	Accept

Based on the result of the first round FDM, experts suggested that the Gagne nine steps of instructional model should be replaced with other more suitable theory as the last few steps were not suitable to be used to evaluate YouTube videos.

The last few steps in the Gagne nine steps of instructional model are ‘Provide feedback assess performance’ and ‘enhance retention and transfer to the job’. The criteria under the steps appear to be not suitable to support the steps, for instance, assessment performance had to be carried out by the educator or adults to evaluate the performance of the children but YouTube videos were unable to assess their performance as YouTube videos do not offer personalized interaction to assess children performance. Thus it was concluded that the rubric as a criterion to evaluate YouTube videos was found to be not supportive.

A few items from the rubrics were stated too generally and as a result, the panel of experts did not give consensus to approve. However, suggestions were given to improve the meaning, subsequently amended to a more suitable evaluation item. The followings were the improved items.

Table 9. Items amendments according to experts’ comments

Item	Original	Concerns	Amendments
Item 1	Does the video gain attention of viewers?	Experts pointed out that this statement is not specific enough to evaluate YouTube. According to Bandura (1962) and Godwins-Jones and Technology (2011) student engagement is the foundation of constructive learning.	Does the video show interesting elements to gain the attention of viewers?
Item 5	Are learning elements highlighted in the video?	Experts suggested that the word highlighted needs to be defined specifically. This question is general and difficult to judge if the learning element is highlighted. Mayer (2009) asserted that the learning element in a video is actually one of the important items in educational videos based on signaling. It is a component in the Cognitive Theory of Multimedia Learning that helps to guide learner attention to ensure learning process occurs. In order to make it more understandable and user-friendly	Are learning elements seen in the video?
Item 6	Does the video consider learners’ prior knowledge?	Experts suggested to rephrased the statement so that it is clearer for user to understands. This is because videos that are based on students’ prior knowledge makes it easier for them to understand new information.	Does the video suit the learner’s prior knowledge?

Item 7	Does the content share similarities with the child (e.g. age, gender, interests)?	Experts also suggested that the words in this statement were unsuitable to be an evaluation statement, they needed to be replaced with more suitable words so that it can be more accurate to evaluate the educational element in the YouTube video.	Does the content suitable to the child (e.g. age, gender, background)?
item 15	Can the child imitate the content presented (e.g. repeat a song, make body movements or gestures)?	This item does not get expert consensus because the term imitate is not specify if it is immediate imitation or long-term imitation such as behavior change. To ensure this item is able to evaluate the video accurately, it is suggested to change it to simple and clear statement.	Are the content easy to follow by children?
Item 9	Is the size of the video suitable for viewers?	With the highest d value among all the items which is 0.255, with expert's consensus 66.67% and fuzzy score of 0.467 the lowest among all the items. Experts commented that video size can hardly affect children learning and this item can be eliminated as it does not contribute much to evaluation and it can be dropped.	Rejected
Item 22	Does the video encourage children to perform the creative tasks?	With the d value 0.216 and 66.67% expert's consensus. Experts asserted that creative tasks overlap with items 22 and 23 that evaluate if the video encourages children to solve the problem and provide alternative ideas of ways of doing things.	Rejected

Whereas there are two items which were rejected as recommended by experts. The items has obtain the d value of more than 0.2 and less than 75% of overall experts consensus indicated that the experts consensus was not achieved. Hence, the items were dropped based on experts comments and analysis. The items are:

Under the fourth instructional step- present the content. Item- is the size of the video suitable for viewers? The d value is 0.255 which is the highest among all the items, 66.67% of experts consensus and the fuzzy score is 0.467 the lowest among all the items. This item was dropped as experts did not agree that video size is relevant to learning and the video size is about the size of video show on screen or the digital content size. Both of them are not important and will not affect children learning through video hence it was dropped.

The last step is enhance retention and transfer to the job, item 22 – Does the video encourage children to perform creative tasks? With d value 0.216 and 66.67% experts' consensus this item was suggested to be dropped. Experts commented that creative tasks is subjective that it is hard to evaluate what is consider creative task. The item also overlaps with the items Does the video encourage children to solve problem? and Does the video encourage children to provide alternative ideas or ways of doing things? So this item was rejected eventually.

The Gagne nine steps of the instructional model were replaced by applying the three elements which are cognitive load, students engagement and active learning for effective educational videos proposed by Brame (2016) with literature reviews and suggestions on practical ways when using videos as educational tool.

Round 2 FDM

Revised Questionnaire

Based on experts' recommendation, a section also has been added in front page of the rubric to explain the function, content and instruction of how to use the rubric. A section for date, video title, learning purpose/ objective and duration of the video were added for teachers or parents to keep it as a record in the future. At the back of the rubric, a brief justification about the elements in the rubric to give user a better understanding about the element they were evaluating was added.

To replace the Gagne instructional model, the rubric has been amended by applying the three elements which are cognitive load, students engagement and active learning for effective educational videos proposed by Brame (2016) with literature reviews and suggestions on practical ways when using videos as educational tool.

The first part of the rubric is Cognitive load based on Cognitive Load Theory suggested that educational materials should not add to the superfluous cognitive load, since this will result in cognitive overload and a reduction in the learning effect (Leppink et al., 2014). Under the same theory, Cognitive Theory of Multimedia Learning (CTML) presented that the most essential outcome for teaching and learning with video is that learning with a mix of text and picture is more effective than learning with only a text, and that picture with spoken text is preferable than the picture, written and spoken text, and only picture and text.

The second part is student engagement, Engagement is essential for learning since students cannot learn if they do not watch the video. Video length, personalization, and appropriate video material will help improve student engagement (Guo et al., 2014). Keep it short is the first and most crucial rule for enhancing student attention to educational video. Guo et. al, 2014 asserted that in their research they discovered that for videos less than 6 minutes in length, the median engagement time was close to 100%. Students are more engage when they feel that the videos are personalized for them. The content of the videos consist of their favorite character such as Elsa, Sponge bob, Didi and friends make them attracted to the videos. The language used in the video also plays an important a vital role as children tend to be more enthusiastic to watch the video if they can understand the language in the video.

The third part is active learning. Children connect with people and ideas, develop knowledge through physical and mental activity, and are actively involved in problem-setting and problem-solving tasks as part of active learning. Experimenting with movement and the senses is an important aspect of a child's learning and development. Active learning can be maximized by using interactive features that give students control (Qi et al., 2006) and guiding questions (Lawson et al., 2006). The characteristic of active learning in early years of child can be seen if they are able to focus on the activity in the video by following the instruction, trying to imitate the actions shown in the video and being persistent to overcome the challenges.

Table 6. Refined YouTube evaluation rubric- Brame (2016) effective educational videos elements

This rubric function as an assessment to the educational quality of a video for teachers and parents to select suitable educational YouTube video for preschool children.

1. The main criteria are divided into 3 sub criteria : Cognitive load, students engagement and active learning.
2. A 2 point system were used to assess each question and produce a total numeric assessment per video, No= 0 point and Yes = 1 point.
3. Total scores were calculated by summing the sub-criteria scores.
4. The overall quality rating classification of a video is the total : < 11 not recommended ; ≥ 11 recommended.

Date:

Video title:

Learning purpose/ objective:

Duration:

No	Criteria	0 - No	1-Yes	Remark
A. Cognitive load				
1.	Does the learning objective stated in the beginning of the video?			
2.	Are learning elements seen in the video?			
3.	Is each scene clear, logical, and easy to follow?			
4.	Are pictures/ graphic/ animations presented alongside words/ narration?			
5.	Are social relationship shown suits the culture of the viewers?			

B. Student engagement				
6.	Does the duration/ length of the video suitable for viewers?			
7.	Does the video show interesting element to gain attention of viewers?			
8.	Does the video retain attention of viewers?			
9.	Does the video keeps viewers motivated to learn throughout?			
10.	Does the video consider learners' prior knowledge?			
11.	Does the content suitable to the child (e.g. age, gender, background)?			
12.	Are the images, audio, sounds and language used appropriately for children (i.e. the children can understand the content)?			

C. Active learning				
13.	Is interactive conversation style used in the video?			
14.	Does the video encourage children to repeat the content?			
15.	Are the content easy to follow by the children (e.g. repeat a song, make body movements or gesture)?			
16.	Is some content repeated during the video (e.g. to reinforce learning in positive ways)?			
17.	Does the on-screen behaviour receive appropriate reinforcement (e.g. positive behaviour is praised or encouraged and negative behaviour is discourages)?			
18.	Does the video support cognitive development (e.g., language, literacy)?			
19.	Does the video support physical development (e.g., gross and fine motor skills)?			
20.	Does the video support socio-emotional development (e.g., foster positive relationships, communication skills, moral attitudes, resilience, self-regulation, self-confidence)?			
21.	Does the video encourage children to solve problems?			
22.	Does the video encourage children to provide alternative ideas or ways of doing things?			
Total				

Cognitive load

- Cognitive Load Theory suggest that educational material should not increase the extraneous cognitive load as it will lead to cognitive overload and hinder the learning effect (Paas & Sweller, 2014; Zumbach, 2010)
- Cognitive Theory of Multimedia Learning (CTML) proposed that the most important result for teaching and learning with video is that learning with a combination of text and picture is more effective than learning with just a text and that picture with spoke text is better than picture, written and spoken text as well as just picture and text.

Student engagement

- Engagement is the energy in action which is the connection between person, content and activities during the teaching and learning process.
- If students don't watch the video, they can't learn them.
- Video length, personalization, suitable video content will enhance student engagement (Guo et. al, 2014)

Active learning

- To help students get the most out of an educational videos is to encourage active learning.
- Use interactive features that give students control (Zhang et. al, 2006)
- Use guiding questions (Lawson et. al, 2006).

Table 7. Result of round 2 Fuzzy Delphi method

No	Steps/ Item	Triangular Fuzzy Numbers		Defuzzification Process	Ranking
		Threshold (d)	Experts consensus (%)	Fuzzy (A)	
Cognitive load					
1	Is the learning objective stated in the beginning of the video?	0.149	100.0%	0.683	3
2	Are learning elements seen in the video (Eg. vocabulary, mathematics, moral value)?	0.136	100.0%	0.733	1
3	Is each scene clear, logical, and easy to follow?	0.153	100.0%	0.700	2
4	Are pictures/ graphic/ animations presented alongside words/ narration?	0.115	100.00%	0.650	4
4	Are social relationship shown suits the culture of the viewers?	0.085	100.00%	0.567	5
Student engagement					
6	Is the duration of the video suitable for children?	0.153	100.00%	0.700	1
7	Does the video show interesting element to gain attention of viewers?	0.178	91.67%	0.700	2
8	Does the video retain attention of viewers?	0.178	91.67%	0.683	3
9	Does the video keeps viewers motivated to learn throughout?	0.170	91.67%	0.633	4
10	Does the video consider learners' prior knowledge?	0.255	83.33%	0.633	5
11	Does the content suitable to the child (e.g. age, gender, background)?	0.140	83.33%	0.617	6
12	Are the images, audio, sounds and language used appropriately for children (i.e. the children can understand the content)?	0.187	83.33%	0.617	7
13	Is interactive conversation style used in the video?	0.140	83.33%	0.617	8
Active learning					
14	Does the video encourage children to repeat the content?	0.187	83.33%	0.617	7

15	Are the content of the video easy to follow by the children (e.g. repeat a song, make body movements or gesture)?	0.204	83.33%	0.667	8
16	Is some content repeated during the video (e.g. to reinforce learning in positive ways)?	0.238	83.33%	0.667	1
17	Does the on-screen behaviour receive appropriate reinforcement (e.g. positive behaviour is praised or encouraged and negative behaviour is discouraged)?	0.238	83.33%	0.667	2
18	Does the video support cognitive development (e.g., language, literacy)?	0.229	83.33%	0.650	3
19	Does the video support physical development (e.g., gross and fine motor skills)?	0.233	83.33%	0.617	4
20	Does the video support socio-emotional development (e.g., foster positive relationships, communication skills, moral attitudes, resilience, self-confidence)?	0.229	83.33%	0.650	9
21	Does the video encourage children to solve problems?	0.267	83.33%	0.650	5
22	Does the video encourage children to provide alternative ideas or ways of doing things?	0.277	83.33%	0.617	6

Response from the experts were key into the templates for calculation. The first data interpretation condition was the d value, the items under cognitive load element displayed d value lesser than 0.2 hence all the items were accepted. The second data interpretation condition will be percentage of experts consensus, the item will be excepted if the percentage is equal or more than 75%. Whereas the third condition is looking at the average fuzzy score (A) or the α -cut that obtain through defuzzification process.

For the element student engagement and active learning some items have exceed 0.2 d value. So the data will be interpreted using the second condition which is expert consensus more than 75%. The overall percentage of the 22 items exceed 75%. This indicated that all the items in the rubric could be accepted based on this condition. According to the third condition which is based on the α -cut or it can be refer to the average fuzzy score (A) that obtain through defuzzification process. The item can be accepted if the fuzzy score is equal or more than 0.5. All the items obtained more than 0.5 fuzzy score with the value between 0.567 and 0.733 and all the items are accepted. This means that the experts have obtained the necessary level of agreement on the items in the rubric to evaluate educational videos for preschoolers. Second round Fuzzy Delphi has acquired better result compare to the first round. Each of the items

were ranked according to their importance to their respective elements by referring to the Amax value.

Table 8. Refined YouTube evaluation Rubric

This rubric function as an assessment to the educational quality of a video for teachers and parents to select suitable educational YouTube video for preschool children.

1. The main criteria are divided into 3 sub criteria : Cognitive load, students engagement and active learning.
2. A 2 point system were used to assess each question and produce a total numeric assessment per video, No= 0 point and Yes = 1 point.
3. Total scores were calculated by summing the sub-criteria scores.
4. The overall quality rating classification of a video is the total : < 11 not recommended ; ≥ 11 recommended.

Date:

Video title:

Learning purpose/ objective:

Duration:

No	Criteria	0 No	1 Yes	Remark
A. Cognitive load				
1.	Are learning elements seen in the video (Eg. vocabulary, mathematics, moral value)?			
2.	Is each scene clear, logical, and easy to follow?			
3.	Is the learning objective stated in the beginning of the video?			
4.	Are pictures/ graphic/ animations presented alongside words/ narration?			
5.	Are social relationship shown suits the culture of the viewers?			

B. Student engagement				
6.	Is the duration of the video suitable for children?			
7.	Does the video show interesting element to gain attention of viewers?			
8.	Does the video retain attention of viewers?			
9.	Does the video keeps viewers motivated to learn throughout?			
10.	Does the video consider learners' prior knowledge?			
11.	Does the content suitable to the child (e.g. age, gender, background)?			
12.	Are the images, audio, sounds and language used appropriately for children (i.e. the children can understand the content)?			
13.	Is interactive conversation style used in the video?			

C. Active learning				
14.	Is some content repeated during the video (e.g. to reinforce learning in positive ways)?			
15.	Does the on-screen behaviour receive appropriate reinforcement (e.g. positive behaviour is praised or encouraged and negative behaviour is discouraged)?			
16.	Does the video support cognitive development (e.g., language, literacy)?			
17.	Does the video support physical development (e.g., gross and fine motor skills)?			
18.	Does the video encourage children to solve problems?			
19.	Does the video encourage children to provide alternative ideas or ways of doing things?			
20.	Does the video encourage children to repeat the content?			
21.	Are the content of the video easy to follow by the children (e.g. repeat a song, make body movements or gesture)?			
22.	Does the video support socio-emotional development (e.g., foster positive relationships, communication skills, moral attitudes, resilience, self-confidence)?			
	Total			

Justification:

Cognitive load

- Cognitive Load Theory suggest that educational material should not increase the extraneous cognitive load as it will lead to cognitive overload and hinder the learning effect (Paas & Sweller, 2014; Zumbach, 2010)
- Cognitive Theory of Multimedia Learning (CTML) proposed that the most important result for teaching and learning with video is that learning with a combination of text and picture is more effective than learning with just a text and that picture with spoke text is better than picture, written and spoken text as well as just picture and text.

Student engagement

- Engagement is the energy in action which is the connection between person, content and activities during the teaching and learning process.
- If students don't watch the video, they are unable to learn from the videos.
- Video length, personalization, suitable video content will enhance student engagement (Guo et. al, 2014)

Active learning

- To help students get the most out of an educational videos is to encourage active learning.
- Use interactive features that give students control (Zhang et. al, 2006)
- Use guiding questions (Lawson et al, 2006).

DISCUSSION

This paper focuses on the application of Fuzzy Delphi method (FDM) in phase 2- design and development phase in Design and Development Research. The FDM was used for refined YouTube evaluation rubric validation as this is a scientific statistical analysis method to obtain agreement from experts (Hsu, 2007) that strengthens the validity of the questionnaire to evaluate educational YouTube videos for preschoolers. The experts were able to express their professional views freely about the items in the rubric based on their experience in preschool education and pedagogy (Ismail et al, 2021; Lesmond et al, 2016). According to Jacobs (1996), Taylor and Judd (1989) to ensure the results of this validation are reliable, the most important step is the selection of experts as it will affect the quality of the result of the study. 12 experts which are lecturers and teachers with preschool education and pedagogy background and more than 10 years of teaching experience were selected. FDM is proven to be a good option in developing, designing, and verifying models as it saves time and cost especially if it is conducted online (Ismail et al, 2021).

For the first round of FDM, the total number of items in the rubric was 24. The five-point Likert scale was used to validate the rubric. From experts' comments, some of the items were amended to be more specific and clear to evaluate educational YouTube videos. While 2 items which are Is the size of the video suitable for viewers? and Does the video encourage children to perform creative tasks? were dropped because the items do not get experts consensus, they suggested that the items did not contribute to evaluate educational YouTube videos.

The theory applied in the rubric was changed from Gagne Nine Steps of Instructional model to Brame (2016) elements in effective educational videos which are cognitive load, student engagement and active learning. Cognitive Load Theory suggested that educational material should not increase the extraneous cognitive load as it will lead to cognitive overload and hinder the learning effect (Paas & Sweller, 2014; Zumbach, 2010) while Cognitive Theory of Multimedia Learning (CTML) proposed that the most important result for teaching and learning with video is that learning with a combination of text and picture is more effective than learning with just a text and that picture with spoke text is better than picture, written and spoken text as well as just picture and text. For student engagement, it is the energy in action which is the connection between person, content and activities during the teaching and learning process. If students don't watch the video, they are unable to learn. Whereas video length, personalization, suitable video content will enhance student engagement (Guo et. al, 2014). Active learning involved helping students get the most out of an educational videos by using interactive features that give students control (Zhang et. al, 2006) and guiding questions (Lawson et al, 2006). In round 2 FDM better result were obtained compare to round 1 FDM, experts have obtained the necessary level of agreement on the items in the rubric to evaluate educational videos for preschoolers hence all 22 items were accepted and the items were rearranged according to their importance to their respective elements by referring to the Amax value. The importance of running the second round of the FDM was that it will further enhance the validity of the rubric in evaluating educational YouTube videos for preschoolers.

CONCLUSION

In conclusion, the design of the study was conducted using the Design and Development Research (DDR) approach that consist of three phases which are the need analysis phase, design and development phase, and the evaluation phase. This article focus on the validation

process of the second phase which is design and development phase. The rubric was adapted from Neumann et al. (2020) YouTube evaluation rubric and was refined based on the literature review regarding to the criteria of educational YouTube videos. The refined rubric were validated using Fuzzy Delphi method that has high validity and reliability. The selection of lecturers and teachers in the field of pedagogy and preschool as experts in this study is very significant. They possessed at least 10 years of experience in teaching and pedagogy for preschoolers, hence they were able to provide quality feedbacks and validate the rubric for the evaluation of education videos. All experts confirmed that the rubric is suitable for evaluating educational YouTube videos for preschoolers. The findings enable the continuation to the next phase which is to test the effectiveness of the rubric.

REFERENCES

- Abdullah, J. B. B., & Yusof, S. I. B. M. (2018). A fuzzy Delphi method-developing high-performance leadership standard for Malaysian school leaders. *Journal of Education and Social Sciences*, 9(2), 1-10.
- Abdullah, M. N. L. Y., Fook, F. S., & Lan, O. S. (2010). An evaluation of instructional videos in eduwebtv: Technical qualities, pedagogical aspects, engagement and perceived impact on learning. *Journal of Educational Technology*, 10(2), 101-113.
- Abdullah, M. R. T. L., & Siraj, S. (2018). The Evaluation of mLearning Implementation of Model for English Language Learning Via Fuzzy Delphi Method. *Pertanika Journal-Social Sciences y Humanities*, Selangor, 26, 33-54.
- Bada, S. O., & Olusegun, S. (2015). Constructivism learning theory: A paradigm for teaching and learning. *Journal of Research & Method in Education*, 5(6), 66-70. DOI: 10.9790/7388-05616670
- Bandura, A. (1961). *Social foundation of thought and action: A social cognitive theory*. Upper Saddle River, NJ: Prentice-Hall
- Brame, C. J. (2016, 2016). *Effective Educational Videos: Principles and Guidelines for Maximizing Student Learning from Video Content*. *CBE Life Sci Educ*, 15(4). <https://doi.org/10.1187/cbe.16-03-0125>
- Brualdi, A. C. (1996). *Multiple Intelligences: Gardner's Theory*. ERIC Digest.
- Duffy, M. E. (2002). Methodological issues in web-based research. *Journal of Nursing Scholarship*, 34(1), 83-88.
- Godwin-Jones, R. (2011). Mobile apps for language learning. *Language learning & technology*, 15(2), 2-11.
- Guo, P. J., Kim, J., & Rubin, R. (2014, March). How video production affects student engagement: An empirical study of MOOC videos. In *Proceedings of the first ACM conference on Learning@ scale conference* (pp. 41-50). <https://doi.org/10.1145/2556325.2566239>
- Heale, R., & Twycross, A. (2015). Validity and reliability in quantitative studies. *Evidence-based nursing*, 18(3), 66-67. <http://dx.doi.org/10.1136/eb-2015-102129>
- Hsu, C. C., & Sandford, B. A. (2007). The Delphi technique: making sense of consensus. *Practical assessment, research, and evaluation*, 12(1), 10. <https://doi.org/10.7275/pdz9-th90>
- Ismail, K., Ishak, R., & Kamaruddin, S. H. (2021). Development of professional learning communities model using fuzzy delphi approach. *TEM Journal*, 10(2), 872-878.
- Jacobs, J. M. (1996). *Essential assessment criteria for physical education teacher education programs: A Delphi study*. West Virginia University.
- Jailani, M. A. (2020). *The Application of Fuzzy Delphi Method in Content Validity Analysis* (No. 4535). EasyChair.

- Jones, H., & Twiss, B. C. (1978). *Forecasting technology for planning decisions*. New York: Macmillan
- Kadir, W. N. H. W. A., Abdullah, N. S. Y., & Mustapha, I. R. (2019). The Application of the Fuzzy Delphi Technique on a Component of Development of Form Four STEM-Based Physics Interactive Laboratory (I-Lab). *International Journal of Scientific & Technology Research*, 8(12), 2908-2912.
- Karim, E., Ahmad, J., & Osman, K. (2017). Fuzzy Delphi method for content validation of integrated science process skills instrument. *International Journal of Academic Research in Business and Social Sciences*, 7(6), 773-785. DOI: 10.6007/IJARBS/v7-i6/3037
- Kruse, K. (2009). Gagne's nine events of instruction: An introduction. Retrieved the, 10
- Lawson, T. J., Bodle, J. H., Houlette, M. A., & Haubner, R. R. (2006). Guiding questions enhance student learning from educational videos. *Teaching of Psychology*, 33(1), 31-33. https://doi.org/10.1207/s15328023top3301_7
- Leppink, J., Paas, F., Van Gog, T., van Der Vleuten, C. P., & Van Merriënboer, J. J. (2014). Effects of pairs of problems and examples on task performance and different types of cognitive load. *Learning and Instruction*, 30, 32-42. <https://doi.org/10.1016/j.learninstruc.2013.12.001>
- Lesmond, G., Dawe, N., Romkey, L., McCahan, S., (2016). Using a Delphi Study to Develop Criteria for an Analytic, Competency-Based Rubric.
- Mayer, R. E., Fiorella, L., & Stull, A. (2020). Five ways to increase the effectiveness of instructional video. *Educational Technology Research and Development*, 68(3), 837-852. <https://doi.org/10.1007/s11423-020-09749-6>
- Megaly, M., Khalil, C., Tadros, B., & Tawadros, M. (2016). Evaluation of educational value of YouTube videos for patients with coeliac disease. *International Journal of Celiac Disease*, 4, 102-4.
- Michnuik, A. (2014). YouTube – YouLearn. Education via YouTube? *E-Mentor*, 56(4), 37-43. doi: 10.15219/em56.1122
- Mohd Jamil, M. R., Siraj, S., Hussin, H., Mat Noh, N., & Sapar, A. A. (2017). Pengenalan Asas Kaedah Fuzzy Delphi dalam Penyelidikan Rekabentuk dan Pembangunan. *Bangi: Minda Intelek*. <https://spaj.ukm.my/jalhikmah/index.php/jalhikmah/article/view/201>
- Mohd Jamil, M. R., & Mat Noh, N. (2020). *Kepelbagaian Metodologi dalam Penyelidikan Reka Bentuk dan Pembangunan*. *Bangi: Qaisar Prestige Resources*. <https://doi.org/10.24191/ajue.v17i1.12625>.
- Moussiades, L., Kazanidis, I., & Iliopoulou, A. (2019). A framework for the development of education video: An empirical approach. *Innovations in Education and Teaching International*, 56, 217-228. <http://doi.org/10.1080/14703297.2017.1399809>
- Murray, T. J., Pipino, L. L., & Van Gigch, J. P. (1985). A pilot study of fuzzy set modification of Delphi. *Human Systems Management*, 5(1), 76-80.
- Mustapha, R., & Darusalam, G. (2017). *Aplikasi kaedah Fuzzy Delphi dalam Kajian Sians Sosial*. Penerbitan Universiti Malaya. Kuala Lumpur
- Neumann, M. M., & Herodotou, C. (2020). Evaluating YouTube videos for young children. *Education and Information Technologies*, 25(5), 4459-4475. DOI 10.1007/s10639-020-10183-7
- Pill, J. (1971). The Delphi method: substance, context, a critique and an annotated bibliography. *Socio-economic planning sciences*, 5(1), 57-71. [https://doi.org/10.1016/0038-0121\(71\)90041-3](https://doi.org/10.1016/0038-0121(71)90041-3)
- Qi, G. J., Song, Y., Hua, X. S., Zhang, H. J., & Dai, L. R. (2006, June). Video annotation by active learning and cluster tuning. In *2006 Conference on Computer Vision and Pattern Recognition Workshop (CVPRW'06)* (pp. 114-114). IEEE. DOI: [10.1109/CVPRW.2006.211](https://doi.org/10.1109/CVPRW.2006.211)

- Ramli, H. A., Hussin, Z. Mohd Jamil, M. R., Sapar, A. A., Siraj, S., & Mat Noh, N. (2014). Aplikasi Teknik Fuzzy Delphi Terhadap Keperluan Aspek 'Riadhah Ruhyyah' Untuk Profesionalisme Perguruan Pendidikan Islam. *The Online Journal of Islamic Education*. Vol. 2 Issue 2: 53-72. <https://doi.org/10.24191/ajue.v17i1.12625>.
- Richey, R. C., & Klein, J. D. (2014). Design and development research: Methods, strategies, and issues. Routledge.
- Richey, R.C., & Nelson, W. (1996). Developmental research. In D. Jonassen (Ed.), Handbook of research fo educational communications and technology (pp.1213-1245). New York: Simon & Schuster.
- Richey, R.C., & Nelson, W. (2004). Developmental research: Studies of instructional deisgn and development. Retrieved on 31st March 2021 from <http://www.aect.org/edtech/41.pdf>
- Schaap, H., & de Bruijn, E. (2018). Elements affecting the development of professional learning communities in schools. *Learning environments research*, 21(1), 109-134. DOI: 10.18421/TEM102-48
- Shukri, M. R. M., & Ariffin, S. A. (2020, October). Evaluation of Mobile Game Based Learning Heuristic Using Fuzzy Delphi Technique for Primary School Science Subject in Malaysia. In World Conference on Mobile and Contextual Learning (pp. 105-110).
- Sulaiman, H. F., Ismail, R., Mohd Yusoff, H., Anuar, N., Mohd Jamil, M. R., & Daud, F. (2020). Validation of Occupational Zoonotic Disease Questionnaire Using Fuzzy Delphi Method. *Journal of agromedicine*, 25(2), 166-172. <https://doi.org/10.1080/1059924X.2019.1666763>
- Yaghmale. (2003). Content validity and its estimation. DOI: [10.22037/jme.v3i1.870](https://doi.org/10.22037/jme.v3i1.870)

Appendix

YouTube video evaluation rubric (Neumann et al., 2020)

Criteria	Sub-criteria (Evaluation questions)	0 No	1 Partial evidence	2 Yes
Age appropriate	1. Can the child imitate the content presented (e.g. repeat a song, make body movements or gesture)?			
	2. Does the content share similarities with the child (e.g. age, gender, interests)?			
	3. Is the behaviour on-screen positive (e.g. ethical, fair, caring, moral, non-violent, non-scary, healthy)?			
	4. Does the on-screen behaviour receive appropriate reinforcement (e.g. positive behaviour is praised or encouraged and negative behaviour is discouraged)?			
Content quality	5. Are social relationship accurately represented (e.g. gender and cultural stereotypes, power relationship)?			
	6. Does the video encourage children to perform creative tasks, solve problems or provide alternative ideas or ways of doing things?			
	7. Does the video encourage children to repeat the content?			
	8. Are the images, audio, sounds and language used appropriately for children (i.e. the children can understand the content)?			
	9. Is each scene clear, logical, and easy to follow?			
Design features	10. Is some content repeated during the video (e.g. to reinforce learning in positive ways)?			
	11. Is there low and gradual pace with infrequent scene and character changes?			
	12. Are pictures/ graphic/ animations presented alongside words/ narration?			
	13. Is conversation style used in wording (oral and written)?			
	14. Are learning elements highlighted in the video?			
Learning objectives	15. Does the video support cognitive development (e.g., language, literacy, fine motor skills)?			
	16. Does the video support physical development (e.g., gross and fine motor skills)?			
	17. Does the video support socio-emotional development (e.g., foster positive relationships, communication skills, moral attitudes, resilience, self-regulation, self-confidence)?			
Total Score Quality Rating 0 to < 17: Not Recommended; 17 to 34: Recommended				

Sustainability-Driven Entrepreneurial Intention Among Students in Malaysian Community Colleges: Some Initial Observations

Norsalwati Mohd Razalli
Universiti Pendidikan Sultan Idris
sal010287@gmail.com

Nurul Nuha Harun
Kolej Komuniti Manjung
nurul.nuha@kkcm.edu.my

Zainal Ariffin Ahmad
Academy of Sciences Malaysia
drzaba2012@gmail.com

ABSTRACT

The Malaysian government aimed to develop more competitive and innovative graduates to propel the country into becoming a high-income nation by 2025, in line with the Eleventh Malaysia Plan. In support of this initiative, the Department of Polytechnic and Community College Education (DPCCE) developed the Blueprint for Smart Green Polytechnic and Community Colleges (BSGPC) 2021-2026. The blueprint serves as a guideline to inculcate green entrepreneurship among students to become more innovative graduates. Therefore, this study aims to investigate the sustainability-driven entrepreneurial intention among community college students in Malaysia. Based on the Theory of Planned Behaviour (TPB), we investigated the relationships between subjective norms (SN), sustainability attitude (SA), and sustainability self-efficacy (SSE) with sustainability entrepreneurial intention (SEI). This study used a quantitative design based on the positivist approach. Data were collected using questionnaires from a sample of 83 final-year community college students in the Fashion and Apparel Programme. Based on structural equation modelling (SEM) using SMART PLS-SEM 3.0 software, the findings found significant relationships between SSE and SA with SEI among community college students. Several recommendations are presented for consideration for polytechnic and community colleges via the DPCCE to inculcate green entrepreneurship in the curriculum.

Keywords: Sustainability Norms; Sustainability Self-efficacy; Sustainability Attitude; Sustainability Entrepreneurial Intention; PolyCC SmartGreen Blueprint

INTRODUCTION

In line with the United Nations Sustainable Development Goals (SDG), sustainable or green entrepreneurship is seen as a solution to the world's problems of poverty (SDG 1), hunger (SDG 2), and climate change (SDG 13), as suggested by Dean and McMullen (2007) and Porter and Kramer (2011). As such, academics in Malaysia have taken a keen interest in sustainable entrepreneurship especially considering Education for Sustainable Development (ESD) in preparing more competitive and innovative graduates for Malaysia to become a high-income nation by 2025. Moreover, it is important to encourage growth among students to become entrepreneurs in the high-income environment considering the economic and talent development of the community. Hence, human capital creation through sustainability entrepreneurship activities becomes a critical variable in supporting the economic sector transition through intensive information and innovation activities as proposed in the Malaysian Education Blueprint, Higher Education 2015-2025 (Ministry Higher of Education, 2016).

The Ministry of Higher Education (MOHE) recognizes the importance of technical and vocational education training (TVET) in supporting human capital development with high knowledge and skills in practical and professional fields to enhance economic productivity. As such, the Malaysian Education Blueprint, Higher Education 2015-2025 proposes a holistic approach featuring sustainability entrepreneurship to foster 'work creators' rather than just 'job seekers'. This is done by raising technical and vocational education training programmes (TVET) comparable to conventional academic programmes and making lifelong learning part of the country's culture (Bazkiaei et al., 2021). For this reason, the Department of Polytechnic was merged with the Department of Community College to become the Department of Polytechnic and Community College Education (DPCCE) under the MOHE. Furthermore, DPCCE was tasked to carry out sustainability entrepreneurship activities in meeting the country's challenges, industry demands, growing global technological advances, and current needs to produce a skilled and sustainable workforce. Therefore, DPCCE has spearheaded this TVET-ESD initiative through its Blueprint for Smart Green Polytechnic and Community Colleges (BSGPC) since 2015. The updated Blueprint for Smart Green Polytechnic and Community Colleges (BSGPC, 2021-2026) in 2020 outlines methods and procedures to inculcate sustainability practices through preserving and conserving the environment among the 36 polytechnics and 105 community colleges in Malaysia. The blueprint will help realize a more comprehensive transformation by considering the SDGs' social, economic, and environmental aspects. Hence, the BSGPC supports the aspirations of SDGs and the Eleventh Malaysia Plan in transforming Malaysia into a high-income, sustainable, and dynamic developing country.

Although entrepreneurial education that emphasizes the advantages of entrepreneurship to economic development has been conducted across the curriculum in Malaysia for a long time, the awareness of entrepreneurship sustainability is still at a low level (Prieger et al., 2016). In fact, Rashid (2019) found that the Entrepreneurial Sustainability Education taught in the curriculum did not emphasize the concept of creativity and innovation to students. The Blueprint for Smart Green Polytechnic and Community Colleges (BSGPC, 2021-2026) highlights a shortage of sustainability elements in the polytechnic and community college curriculum. Sustainability entrepreneurship as an element in the curriculum was found to be less applied, and the integration of sustainability elements was still at the development stage and not performed in full (Bogatyreva et al., 2019; Burzynska et al., 2018). Furthermore, students' understanding of sustainability entrepreneurship was still at a low level as it did not reflect the value of the environment or interest in activities that promote environmental protection (Bhuiyan and Sharma, 2017). Rather, individual characteristic such as personality was found to play an important role in the establishment and success of the business (Wang et al., 2016). Therefore, BSGPC sets an urgent call for sustainability practices to be implemented by incorporating up to 50% of sustainability elements across the curriculum by 2025.

Most students at the community colleges were interested in becoming entrepreneurs, but due to a lack of support and resources, they did not pursue it as a career (Ashour, 2016; Santos and Liguori, 2019). In line with the Theory of Planned Behaviour, many studies emphasize entrepreneurial intention to improve the economy, reduce unemployment and promote small efforts. Still, none focus on factors that lead to sustainability entrepreneurial intention (SEI). As highlighted earlier, the lack of understanding of sustainability entrepreneurship may influence the students' SEI (Qazi et al., 2020). Thus, this study aims to identify the relationship between sustainability norms (SN), sustainability self-efficacy (SSE) and sustainability attitudes (SA) with SEI among students in Malaysian community colleges.

LITERATURE REVIEW

Community Colleges in Malaysia

Community colleges in Malaysia are technical and vocational education training (TVET) institutions under the Ministry of Higher Education (MOHE) committed to providing a platform and opportunity for enhancing skilled workers. Community colleges were established on 5th July 2000, starting with five colleges in Malaysia. To date, there are 105 community colleges established throughout Peninsular Malaysia, Sabah and Sarawak (Portal DPCCE, 2022). Until now, community colleges have offered 117 programmes and enrolled 16,157 students (CCMS Portal, 2021).

In line with Sustainable Development Goal 4 (SDG 4) (Quality Education), the main objective of the Department of Polytechnic and Community College Education (DPCCE) is to offer innovative, high-quality education and training at all levels of society for the workforce. Furthermore, based on DPCCE KPI Dictionary (2022), the vision of DPCCE is to be the leading edge TVET institution. To achieve this vision, the mission statement of DPCCE outlines the following:

- (1) To provide wide access to quality and recognized TVET programmes.
- (2) To empower communities through lifelong learning.
- (3) To develop holistic entrepreneurial and balanced graduates.
- (4) To capitalize on smart partnerships with stakeholders.

The certificate and diploma levels include business, engineering, hospitality and fashion, multimedia, social service, and agrotechnology courses. Graduates of community college foundation programmes may continue their education by enrolling in diploma courses at polytechnic institutions or some specific community colleges. Community colleges now serve as a focal point for lifelong learning, expanding on its original purpose. To improve the quality of the local community's lifestyle, these community colleges provide short-term courses in new talents, training to upgrade existing abilities, and re-skilling training to housewives, retirees, non-governmental organizations (NGOs), etc.

Although community colleges offer numerous programmes and courses for lifelong learning, this study focuses on the Certificate in Fashion and Apparel programme, with 98 students taking an entrepreneurship course during their final semester. Recently, following the call for incorporating sustainability practices by the Blueprint for Smart Green Polytechnic and Community Colleges (BSGPC, 2021-2026), DPCCE embedded technology courses in this programme, such as digital fashion illustration, where students are required to draw fashion design using technology in line with STEM and sustainability rather than using paper as previously practiced (DPCCE, 2020). This approach to enhancing students' knowledge and cultivating attitudes toward sustainability augurs well with the SDGs of quality education (SDG 4) and responsible production and consumption (SDG 12). However, the Fashion and Apparel Programme is only offered in 16 out of 105 community colleges taking advantage of the local community contents and surroundings. Figure 1 shows the distribution of these 16 community colleges offering the Fashion and Apparel Programme in Malaysia.

Research Objectives

The primary aim of this study was to investigate the relationships between sustainability norms (SN), sustainability self-efficacy (SSE) and sustainability attitudes (SA) with sustainability entrepreneurial intention (SEI) among students in 16 community colleges in Malaysia. The three main research objectives are stated below:

- (1) To examine the relationship between sustainability norms (SN) and sustainability entrepreneurial intention (SEI) among community college students in Malaysia.
- (2) To examine the relationship between sustainability self-efficacy (SSE) and sustainability entrepreneurial intention (SEI) among community college students in Malaysia.
- (3) To examine the relationship between sustainability attitudes (SA) and sustainability entrepreneurial intention (SEI) among community college students in Malaysia.

Figure 1: The distribution of Community Colleges offering Fashion and Apparel Programme in Malaysia

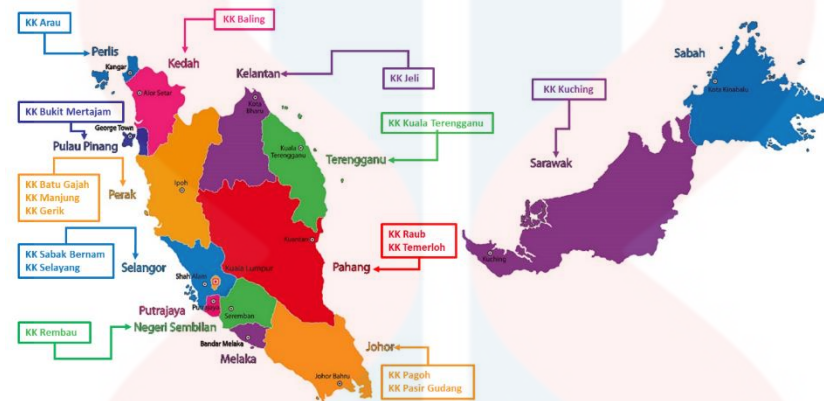

Subjective Norms (SN)

In this study, subjective norm refers to a type of normative belief system that describes the persons or students who would either agree or disagree with a particular activity (in this case, sustainable activity). The focus is on positive subjective norms rather than negative ones pertaining to SEI. When the students believe that other people's support is important and are driven to adhere to their referents' expectations, they feel convinced to engage in specific conduct (Ajzen, 2015). Apart from that, Fishbein and Ajzen (1981) suggest that SN has a positive influence on intention. Students are influenced by the ideas, viewpoints and perceived social pressures from friends or family members involved in sustainability entrepreneurship, and this plays an important role in influencing SEI (Cavazos-Arroyo et al., 2017; Doekhie et al., 2020; Utami, 2017). When they receive a worthy opinion on the ideas of sustainability entrepreneurship among persons and their close links, they will have higher SEI (Banerjee and Ho, 2020). Therefore, it is expected that SN has a positive relationship with SEI (Ambad and Damit, 2016; Bazkiaei et al., 2021; Sargani et al., 2020). Based on the previous literature, this study proposed the following hypothesis:

H1. Subjective norms (SN) have a positive relationship with sustainability entrepreneurial intention (SEI).

Sustainability Self-efficacy (SSE)

Self-efficacy is the individual student's belief in his/her abilities and skills to complete a specific set of tasks and undertake a job (Bandura, 1977). As such, there is an interdependent relationship between actions, behaviour, perception, cognition, and environment. As espoused by the social cognitive theory, self-efficacy has been identified as an essential factor in students' learning because it affects both motivation and learning (Van Dinther et al., 2011).

Other than that, Waris et al. (2021) highlight that an essential component of the sustainability-driven business is entrepreneurial self-efficacy. The authors recommend that financial and technological supports by governments are important in assisting institutions that encourage aspiring business owners to start green companies. Therefore, in this study, it is expected that students with high self-efficacy are more likely to accept sustainability entrepreneurship ideas. Based on the previous literature, this study proposed the following hypothesis:

H2. Sustainability Self-efficacy (SSE) has a positive relationship with sustainability entrepreneurial intention.

Sustainability Attitudes (SA)

Attitude is an important antecedent of behavioural intention in entrepreneurial intention (Ajzen, 1991). SA are inherent beliefs about how the environment, society, or economy should be (Kalsoom, 2019). According to Liñán and Chen (2009), attitude is crucial to entrepreneurship intention. Recently a study by Sargani et al. (2020) identified SA as a significant antecedent of SEI for sustainable entrepreneurship in the agriculture sector. Other studies on entrepreneurship also found that SA was a significant determinant in the formation of SEI (Fayolle et al., 2014; Lakovleva et al., 2011; Sargani et al., 2020; Usaci, 2015; Waris et al., 2021; Zhang et al., 2014). Based on the previous literature, this study proposed the following hypothesis:

H3. Sustainability attitudes (SA) have a positive relationship with sustainability entrepreneurial intention (SEI).

METHODOLOGY

Research model and analysis technique

The present study is based on the Theory of Planned Behaviour (TPB) in identifying the determinants of sustainability-driven entrepreneurial intention among community college students in Malaysia. Prior studies showed that the essential TPB elements, such as subjective norms (SN), sustainability self-efficacy (SSE), and sustainability attitudes (SA), were related to sustainability entrepreneurial intention (SEI) (Ajzen, 1991; Banerjee and Ho, 2020). Moreover, TPB has been widely utilized in Malaysian social science research to comprehend human behaviour (Ali et al., 2018). As a result, Figure 2 shows the conceptual framework for this study. Given the limited sample size in this study, which consisted of 98 students in the Fashion and Apparel Programme at 16 community colleges across Malaysia, we chose to employ Partial Least Square-Structural Equation Modelling (PLS-SEM) (Hair et al., 2019), which was a very valuable tool for refining and extending current theory in entrepreneurial research). Therefore, to evaluate the three hypotheses, Smart-PLS SEM 3.0 was applied (Ringle et al., 2015).

KELANTAN

Figure 2: The conceptual framework

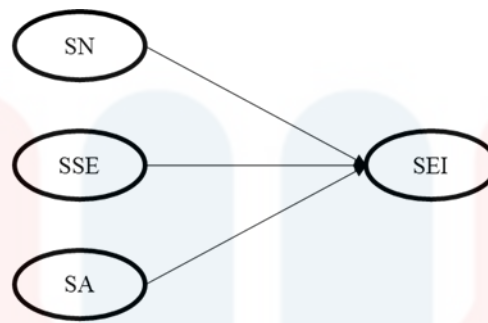

Notes: SEI = sustainability entrepreneurial intention, SN = subjective norms, SSE = sustainability self-efficacy; SA = sustainability attitudes

Sample and data collection

This study was based on quantitative data collected through questionnaires. The instrument for data collection was developed using a five-point Likert scale that ranged from strongly disagree to strongly agree using validated instruments comprising 17 items adapted from previous literature. The items for SN were adapted from Bazkiaei et al. (2021) and Tsai et al. (2016). Items for SSE and SA were adapted from Davidsson (1995); Shahab et al. (2018) and Waris et al. (2021), whereas SEI from Liñán and Chen (2009) and Qazi et al. (2020).

The sample size of this study was determined by following the criterion suggested by Hair et al. (2014). The authors suggested the data of the sample size should be equal to 10 times the number of independent variables in the most complex regression in the PLS path model. Therefore, this study had three constructs ($3 \times 10 = 30$), and a minimum sample size of 30 respondents was deemed adequate to test the statistical model. A total of 83 out of 98 students in the Fashion and Apparel Programme in community colleges across Malaysia responded to the study. The demographic details of the respondents are shown in Table 1, which were predominantly female (79.5%) and Malay (89.2%).

Table 1: Respondent's Profile

	Category	Frequency	%
Gender	Male	17	20.5
	Female	66	79.5
Ethnic	Malay	74	89.2
	Indian	9	10.8
Total		83	

Data Analysis

In this study, the data was measured and analyzed using Smart PLS-SEM 3.0. According to Hair et al. (2019), there are six stages involved in the procedures of PLS-SEM to explain the relationship of latent variables between exogenous (independent variables) and endogenous (dependent variables). However, this study only involved five stages. First, this study aims to investigate the sustainability-driven entrepreneurial intention among community college students in Malaysia. Based on the TPB, we investigated the relationship between SN, SA, and SSE with SEI. Second, we used a questionnaire based on the validated instrument from previous studies and distributed it to 98 final-year students in the Certificate for Fashion and

Apparel Programme. As a result, they were enrolled in the entrepreneurship course. Third, we specified the measurement and structural model based on the conceptual framework. The measurement model consisted of exogenous constructs, SN, SA, and SSE, whereas the endogenous construct was SEI. All the constructs were determined to be reflective items and tested on their internal consistency, convergent validity and discriminant validity. Fourth, we analyzed the measurement model to confirm the reliability and validity of the data. Finally, we tested the structural model to examine the relationships per the proposed hypotheses.

RESULTS AND FINDINGS

Partial Least Square-Structural Equation Modelling (PLS-SEM) was used to analyze the proposed model. PLS-SEM enabled the researchers to explain the relationships among multiple variables simultaneously, factor indeterminacy, data prediction suitability and theory development applicability (Fornell and Bookstein, 1982). Furthermore, data normality was based on the criterion by Hair et al. (2017), with the skewness and kurtosis range between -1 to 1. Thus, the data was normal.

Measurement and structural model analysis

Using the PLS-SEM for the measurement of the model, the reliability of the constructs was based on the criterion set by Hair et al. (2014), with Cronbach’s alpha and composite reliability (CR) greater than 0.7. The values of CR of all the constructs range from 0.920 to 0.940, which is above 0.7, confirming strong reliability among the constructs (Table 2).

Validity was assessed based on the criterion that the values of average variance extracted (AVE) should be greater than 0.5 (Hair et al., 2017). The AVE depicts the degree of shared representation of items with constructs. The values of AVE for all constructs in this study ranged from 0.701 to 0.822. Thus, validity was established.

Table 2: Measurement and structural model analysis

Latent Variables	Items	Convergent Validity			Internal Consistency Reliability	Discriminant Validity
		Outer Loadings	Cronbach’s alpha (α)	AVE (> 0.50)	Composite Reliability (> 0.708)	HTMT
Sustainability Norms (Bazkiaei et al., 2021)	SN1	0.884	0.870	0.794	0.920	HTMT < 0.9 CI < 1.0
	SN2	0.906				
	SN3	0.883				
Sustainability Self-efficacy (Shahab et al., 2018)	SSE1	0.717	0.914	0.701	0.933	
	SSE2	0.837				
	SSE3	0.856				
	SSE4	0.869				
	SSE5	0.879				
	SSE6	0.854				
Sustainability Attitudes (Waris et al., 2020)	SA1	0.903	0.920	0.758	0.940	
	SA2	0.867				
	SA3	0.862				
	SA4	0.874				
	SA5	0.847				

Sustainability	SEI1	0.904	0.892	0.822	0.933
Entrepreneurial	SEI2	0.909			
Intention	SEI3	0.908			

(Qazi et al., 2020)

Establishing discriminant validity is crucial to ensure the data's quality and generalizability (Henseler et al., 2015). The degree to which one construct differs from the other is known as discriminant validity (Hair et al., 2014). The heterotrait-monotrait (HTMT) ratio and the Fornell and Larcker (1981) criterion were used in this study to evaluate discriminant validity (Hair et al., 2014; Henseler et al., 2015). The values of AVE for each construct confirmed the presence of discriminant validity by being greater than the intercorrelation values (Farrell, 2010). Furthermore, the square root of AVE is bigger than the inter-correlation between the components, as seen in Table 3, supporting the discriminant validity. Aside from that, the discriminant validity of the notions was evaluated using the HTMT ratio criterion. To establish discriminant validity, the HTMT values must be less than 0.90. (Henseler et al., 2015). The findings of the HTMT ratio are shown in Table 4, which supports the existence of discriminant validity.

Table 3: Correlations of discriminant validity

Indicators	SA	SEI	SN	SSE
SA	<i>0.871</i>			
SEI	0.688	<i>0.907</i>		
SN	0.477	0.535	<i>0.891</i>	
SSE	0.681	0.715	0.643	<i>0.837</i>

Notes: The off-diagonal values represent the correlations between each construct and other constructs, and the diagonals (in italic) represent the square root of AVE.

Table 4: Heterotrait-monotrait ratio (HTMT)

Indicators	SA	SEI	SN	SSE
SA				
SEI	0.751	<i>0.907</i>		
SN	0.534	0.535	<i>0.891</i>	
SSE	0.733	0.715	0.643	<i>0.837</i>

Hypotheses testing

The hypothesis testing of this study was based on path coefficient, significance value and t-statistics. Path coefficient values range between -1 and +1; the value closer to +1 indicates a strong relationship and vice versa; a significance value below 0.05 refers to the acceptance of hypotheses, and t-statistics more than 1.96 refers to the relevance significant level of value. Three hypotheses were tested based on SEI as follows (Table 5):

H1 Subjective norms (SN) has a positive relationship with sustainability entrepreneurial intention (SEI) - not supported ($\beta = 0.104$, $t < 0.747$, $p < 0.000$);

H2 Sustainability Self-efficacy (SSE) has a positive relationship with sustainability entrepreneurial intention (SEI) - supported ($\beta = 0.398$, $t > 2.496$, $p < 0.000$);

H3 Sustainability attitudes (SA) has a positive relationship with sustainability entrepreneurial intention (SEI) - supported ($\beta = 0.013$, $t > 2.991$, $p < 0.000$).

Table 5: Hypotheses assessment summary

Hypotheses	Beta	SE	p values	t values	Decision
------------	------	----	----------	----------	----------

H1: SN → SEI	0.104	0.139	0.456	0.747	Not supported
H2: SSE → SEI	0.398	0.159	0.000**	2.496	Supported
H3: SA → SEI	0.368	0.123	0.000**	2.991	Supported

Notes: Path coefficients (beta); significant at $p < 0.05^{**}$

DISCUSSIONS AND CONCLUSION

This study aimed to investigate the sustainability-driven entrepreneurial intention among students enrolled in the Certificate in Fashion and Apparel Programme in 16 community colleges across Malaysia. The Department of Polytechnic and Community College Education (DPCCE) embedded technology courses such as digital fashion illustration for sustainability practices. Students were required to draw a fashion design using technology rather than paper as previously practised (DPCCE, 2020). This is to cultivate sustainability entrepreneurship in line with Sustainable Development Goals (SDGs) of quality education (SDG 4) and responsible production and consumption (SDG 12).

The findings found significant positive relationships between sustainability self-efficacy (SSE) and sustainability attitudes (SA) with sustainability entrepreneurial intention (SEI) among community college students. These findings are consistent with previous literature (Farooq et al., 2018; Lindquist et al., 2015; Liñán & Chen, 2009; Qazi et al., 2020; Sher et al., 2020; Sargani et al., 2020; Shahab et al., 2019; Tsai et al., 2016a, 2016b; Waris et al., 2021). The results of the study support that the proposed theoretical model is robust in predicting SEI among college community students. As such, studying sustainability entrepreneurship can enhance the students' self-efficacy and attitudes towards sustainability, as found in earlier studies (Sargani et al., 2020; Fayolle et al., 2014; Iakovleva et al., 2011; Usaci, 2015; Koe et al., 2014).

However, the results did not support the relationship between sustainability norms (SN) and SEI among community college students, in contrast to earlier studies (Cavazos-Arroyo et al., 2017; Doekhie et al., 2020; Utami, 2017). This may be partly due to the sample's composition, which was predominantly female and from the same racial background. Hence, the viewpoints and perceived social pressures from friends or family members who perform in entrepreneurship sustainability may not significantly influence their SEI.

LIMITATIONS AND FUTURE RESEARCH

In hindsight, this study may have four limitations in examining the community students' entrepreneurial intent. Therefore, it is recommended that the polytechnic and community colleges, via the Department of Polytechnic and Community College Education (DPCCE), consider the following suggestions for future research in inculcating green entrepreneurship in the curriculum. First, the study only gathered very homogenous cross-sectional data on final-year community college students. Therefore, to better understand the relationship between the constructs over time, future researchers may wish to think about gathering longitudinal data throughout the student's enrolment.

Second, only respondents from the Certificate in Fashion and Apparel Programme who were enrolled in entrepreneurship courses at 16 Malaysian community colleges were included

in this study. Future research could evaluate sustainability-driven entrepreneurship for students in all 117 programmes, and comparisons could be made across various programmes or disciplines like engineering, hospitality and fashion, multimedia, social service, agrotechnology, and business to understand how effective the suggested model of sustainability entrepreneurship is. This would give a comprehensive picture of sustainability-driven entrepreneurship among Malaysian community college students.

Third, this study used a quantitative methodology to examine how the constructs related to one another. In order to better investigate the variables that influence students' behaviour and their propensity for sustainability-driven entrepreneurship, we advise conducting interviews and observational research. In addition, future qualitative research should consider how stakeholders and government pressure to follow environmental regulations and Corporate Social Responsibility (CSR) practices affect sustainability entrepreneurship.

Last but not least, the majority of the sample in the current study were Malay. Chinese students were not represented, in contrast to Malaysia, where they have been prominently involved in business initiatives. Family income, society ideals for sustainable businesses, and family risk-taking propensity may all have an impact, but no data were gathered on these variables. Therefore, it is advised that demographic factors like gender and ethnicity be taken into account, particularly when examining subjective norms or beliefs in sustainability-driven entrepreneurship since this would add to the evidence for the model's efficacy.

In a nutshell, the results of this study show that college students in Malaysia have a considerable propensity toward having entrepreneurial intentions. This study might be expanded to include students in the many programmes offered at community colleges to better educate them for pursuing sustainable entrepreneurship in a high-income emerging nation.

REFERENCES

Journal article:

- Ajzen, I. (1991). The theory of planned behavior. *Organizational behavior and human decision processes*, 50(2), 179-211.
- Ali, M., Ismail, A., Makhbul, Z., & Omar, N. (2018). Exploring the theory of planned behaviour (TPB) in relation to a halal food scandal: The Malaysia Cadbury chocolate case. *International Food Research Journal*, 25, 79-86.
- Ambad, S. N., & Damit, D. H. (2016). Determinants of entrepreneurial intention among undergraduate students in Malaysia. *Procedia Economics and Finance*, 37, 108-114.
- Ashour, S. (2016). Social and business entrepreneurship as career options for university students in the United Arab Emirates: The drive-preparedness gap. *Cogent Education*, 3(1), 1234425.
- Bandura, A. (1977). Self-efficacy: Toward a unifying theory of behavioral change. *Psychological Review*, 84(2), 191-215.
- Bandura, A. (1997). Self-efficacy and health behaviour. *Cambridge Handbook of Psychology, Health and Medicine*, 160-162.
- Banerjee, S., & Ho, S. S. (2020). Applying the theory of planned behavior: Examining how communication, attitudes, social norms, and perceived behavioral control relate to healthy lifestyle intention in Singapore. *International Journal of Healthcare Management*, 13(sup1), 496-503.

- Bazkiaei, H. A., Khan, N. U., Irshad, A., & Ahmed, A. (2021). Pathways toward entrepreneurial intention among Malaysian universities' students. *Business Process Management Journal*, 27(4), 1009-1032.
- Bhuiyan, S., & Sharma, S. K. (2017). Predicting consumer pro-environmental behavioral intention. *Review of International Business and Strategy*, 27(3), 352-368.
- Bogatyрева, K., Edelman, L. F., Manolova, T. S., Osiyevskyy, O., & Shirokova, G. (2019). When do entrepreneurial intentions lead to actions? The role of national culture. *Journal of Business Research*, 96, 309-321.
- Burzyńska, D., Jabłońska, M., & Dziuba, R. (2018). Opportunities and conditions for the development of green entrepreneurship in the Polish textile sector. *Fibres and Textiles in Eastern Europe*, 26(2(128)), 13-19.
- Cavazos-Arroyo, J., Puente-Díaz, R., & Agarwal, N. (2017). An examination of certain antecedents of social entrepreneurial intentions among Mexico residents. *Review of Business Management*, 19(64), 180-218.
- Dean, T. J., & McMullen, J. S. (2007). Toward a theory of sustainable entrepreneurship: Reducing environmental degradation through entrepreneurial action. *Journal of Business Venturing*, 22(1), 50-76.
- Dentchev, N., Baumgartner, R., Dieleman, H., Jóhannsdóttir, L., Jonker, J., Nyberg, T., Rauter, R., Rosano, M., Snihur, Y., Tang, X., & Van Hoof, B. (2016). Embracing the variety of sustainable business models: Social entrepreneurship, corporate intrapreneurship, creativity, innovation, and other approaches to sustainability challenges. *Journal of Cleaner Production*, 113, 1-4.
- Doekhie, K. D., Buljac-Samardzic, M., Strating, M. M., & Paauwe, J. (2020). Elderly patients' decision-making embedded in the social context: A mixed-method analysis of subjective norms and social support. *BMC Geriatrics*, 20(1).
- F. Hair Jr, J., Sarstedt, M., Hopkins, L., & G. Kuppelwieser, V. (2014). Partial least squares structural equation modeling (PLS-SEM). *European Business Review*, 26(2), 106-121.
- Farooq, M. S., Salam, M., Ur Rehman, S., Fayolle, A., Jaafar, N., & Ayupp, K. (2018). Impact of support from social network on entrepreneurial intention of fresh business graduates. *Education + Training*, 60(4), 335-353.
- Farrell, A. M. (2010). Insufficient discriminant validity: A comment on Bove, Pervan, Beatty, and Shiu (2009). *Journal of Business Research*, 63(3), 324-327.
- Fayolle, A., Liñán, F., & Moriano, J. A. (2014). Beyond entrepreneurial intentions: Values and motivations in entrepreneurship. *International Entrepreneurship and Management Journal*, 10(4), 679-689.
- Fishbein, M., & Ajzen, I. (1981). *Belief, Attitude, Intention, and Behavior: An Introduction to Theory and Research*, Addison-Wesley, Reading, MA.
- Fornell, C., & Bookstein, F. L. (1982). Two structural equation models: LISREL and PLS applied to consumer exit-voice theory. *Journal of Marketing Research*, 19(4), 440.
- Fornell, C., & Larcker, D. F. (1981). Evaluating structural equation models with unobservable variables and measurement error. *Journal of Marketing Research*, 18(1), 39-50.
- Hair, J. F., Risher, J. J., Sarstedt, M., & Ringle, C. M. (2019). When to use and how to report the results of PLS-SEM. *European Business Review*, 31(1), 2-24.
- Henseler, J., Ringle, C. M., & Sarstedt, M. (2015). A new criterion for assessing discriminant validity in variance-based structural equation modeling. *Journal of the Academy of Marketing Science*, 43(1), 115-135.
- Iakovleva, T., Kolvereid, L., & Stephan, U. (2011). Entrepreneurial intentions in developing and developed countries. *Education + Training*, 53(5), 353-370.
- Joseph F. Hair, J., Sarstedt, M., Ringle, C. M., & Gudergan, S. P. (2017). *Advanced issues in partial least squares structural equation modeling*. SAGE Publications.

- Kalsoom, Q. (2019). Constructivism and sustainable development. *Encyclopedia of Sustainability in Higher Education*, 292-298.
- Koe, W., Omar, R., & Majid, I. A. (2014). Factors associated with propensity for sustainable entrepreneurship. *Procedia - Social and Behavioral Sciences*, 130, 65-74.
- Liñán, F., & Chen, Y. (2009). Development and cross-cultural application of a specific instrument to measure entrepreneurial intentions. *Entrepreneurship Theory and Practice*, 33(3), 593-617.
- Prieger, J. E., Bampoky, C., Blanco, L. R., & Liu, A. (2016). Economic growth and the optimal level of entrepreneurship. *World Development*, 82, 95-109.
- Qazi, W., Qureshi, J. A., Raza, S. A., Khan, K. A., & Qureshi, M. A. (2020). Impact of personality traits and university green entrepreneurial support on students' green entrepreneurial intentions: The moderating role of environmental values. *Journal of Applied Research in Higher Education*, 13(4), 1154-1180.
- Rashid, L. (2019). Entrepreneurship education and sustainable development goals: A literature review and a closer look at fragile states and technology-enabled approaches. *Sustainability*, 11(19), 5343.
- Ringle, C., Da Silva, D., & Bido, D. (2015). Structural equation modeling with the SmartPLS. *Brazilian Journal of Marketing*, 13(2).
- Santos, S. C., & Liguori, E. W. (2019). Entrepreneurial self-efficacy and intentions. *International Journal of Entrepreneurial Behavior & Research*, 26(3), 400-415.
- Sargani, G. R., Zhou, D., Raza, M. H., & Wei, Y. (2020). Sustainable entrepreneurship in the agriculture sector: The nexus of the triple bottom line measurement approach. *Sustainability*, 12(8), 3275.
- Shahab, Y., Chengang, Y., Arbizu, A. D., & Haider, M. J. (2019). Entrepreneurial self-efficacy and intention: do entrepreneurial creativity and education matter? *International Journal of Entrepreneurial Behavior & Research*, 25(2), 259-280.
- Sher, A., Abbas, A., Mazhar, S., Azadi, H., & Lin, G. (2020). Fostering sustainable ventures: Drivers of sustainable start-up intentions among aspiring entrepreneurs in Pakistan. *Journal of Cleaner Production*, 262, 121269.
- Tsai, K. H., Chang, H. C., & Peng, C. Y. (2016). Refining the linkage between perceived capability and entrepreneurial intention: roles of perceived opportunity, fear of failure, and gender. *International Entrepreneurship and Management*, 12(4), 1127-1145.
- Usaci, D. (2015). Predictors of professional entrepreneurial intention and behavior in the educational field. *Procedia - Social and Behavioral Sciences*, 187, 178-183.
- Utami, C. W. (2017). Attitude, subjective norm, perceived behaviour, entrepreneurship education and self-efficacy toward entrepreneurial intention university student in Indonesia. *European Research Studies Journal*, 20(2), 475-495.
- Van Dinther, M., Dochy, F., & Segers, M. (2011). Factors affecting students' self-efficacy in higher education. *Educational Research Review*, 6(2), 95-108.
- Wang, J., Chang, C., Yao, S., & Liang, C. (2016). The contribution of self-efficacy to the relationship between personality traits and entrepreneurial intention. *Higher Education*, 72(2), 209-224.
- Waris, I., Barkat, W., Ahmed, A., & Hameed, I. (2021). Fostering sustainable businesses: Understanding sustainability-driven entrepreneurial intention among university students in Pakistan. *Social Responsibility Journal*.
- Zhang, Y., Duysters, G., & Cloudt, M. (2013). The role of entrepreneurship education as a predictor of university students' entrepreneurial intention. *International Entrepreneurship and Management Journal*, 10(3), 623-641.

Website:

- College Community Management System. (2021). *College Community Dashboard*.
<https://app.mypolycc.edu.my/ccms/>.
- Curriculum Division: Design and Creative. (2022). *Syllabus digital fashion illustration* [PDF].
Department of Polytechnic and Community College Education.
- Bidang Tumpuan BSGPC*. (n.d.). Web Rasmi SmartGreen PolyCC.
<https://smartgreen.mypolycc.edu.my/v1/index.php/info-korporat/mengenali-kami/bidang-tumpuan>
- Department of Polytechnic and Community College Education. (2022). *Kamus KPI 2022*.
<https://app.mypolycc.edu.my/persist/>
- Department of Polytechnic and Community College Education. (2022). *Information about Polytechnic and Community College Education*. <https://www.mypolycc.edu.my/>.
- Lai, L. Y., Mohamed, S., Mohd Yasin, N., Aziz, N. Z., & Ahmad Zainuddin, S. (2020). *Blueprint SmartGreen PolyCC*. Department of Polytechnic and Community College Education.
<https://smartgreen.mypolycc.edu.my/v1/index.php/info-korporat/blueprint/blueprint-smartgreen-polycc-2021-2026-versi-digital>
- Ministry Higher of Education Malaysia. (2015). *Malaysia Education Blueprint 2015-2025 (Higher Education)*. Ministry of Education Malaysia.
<https://jpt.mohe.gov.my/portal/index.php/en/corporate/development-plan/16-malaysia-education-development-plan-2015-2025>

Information Technology Governance Analysis Using Cobit 5 in Pakis Village Surabaya City

Fajar Annas Susanto

*SI Information Systems, Faculty of Business Economics and Digital Technology,
Universitas Nahdlatul Ulama Surabaya
fajar@unusa.ac.id*

Trian Rahma Sari

*SI Information Systems, Faculty of Business Economics and Digital Technology,
Universitas Nahdlatul Ulama Surabaya
trianrahma019.if19@student.unusa.ac.id*

Ragil Puji Rahayu

*SI Information Systems, Faculty of Business Economics and Digital Technology,
Universitas Nahdlatul Ulama Surabaya
ragilpuji020.if19@student.unusa.ac.id*

ABSTRACT

The role of information technology in an agency or organization cannot be doubted, considering its rapid development over time. Village is one of the places that in its operations relies heavily on information technology. However, the problem that often occurs in organizations or companies is the use of information technology that is not in accordance with expectations, therefore it is necessary to control the use of information technology which is commonly called IT governance. Poor governance of information technology in the process of managing data causes several problems, such as vulnerabilities that pose threats such as loss, destruction, theft, and eavesdropping of data of important institutions or organizations. The purpose of this study is to evaluate IT governance in Village using the COBIT 5 framework on subdomains that are in accordance with the provisions of the agency or company. Village has the main task of carrying out affairs connected to the Dispendukcapil in the field of population administration by using the Klampid system, where this system is used by officers to enter community data to take care of population needs. With the Maturity Level measurement method to measure IT governance performance using the COBIT 5 framework in the Deliver, Service and Support (DSS) domain. Information Technology Governance Audit in Village which focuses on the DSS01 and DSS05 domains which covers the field of implementation and security in services in the IT system and its results, as well as the implementation of support that allows the implementation of this IT system to be effective and efficient in Village.

Keywords: *IT Governance, COBIT 5.0, Maturity Level*

INTRODUCTION

Information Technology (IT) has been widely utilized by various organizations (including government institutions) around the world. The role of information technology in an agency or organization is very important, considering its rapid development over time. Information technology is a very important factor for any company or institution. Companies and institutions present information technology that is able to support the achievement of strategic plans. The strategic objectives of the company to achieve the vision, mission, and objectives of the company or institution (Handoyo, 2020).

Information technology Governance is an integrated part of organizational management that includes leadership, organizational structures and processes that ensure that information technology is utilized as much as possible (Islamiah, 2014). Poor information technology governance in the process of managing data causes several problems, such as system vulnerabilities that pose threats including loss, destruction, theft, and eavesdropping of important institutional or organizational data. In Indonesia, most of the online incidents reported by respondents were related to the leakage of business information such as important internal records or information related to customers, employees and other intellectuals (Apriyansyah et al., 2020).

In addition, the government of the Republic of Indonesia also recommends the implementation of IT in companies or government agencies to improve services to the community in accordance with the Pp. Minister of Communication and Informatics Number: 41 / PER / KOMINFO / 2007 (Shariff, 2018) because there is no IT governance control mechanism so that there are many errors in resource governance, performance measurement, governance of the use of SIAK and service governance (Imtihan et al., 2022)

Many of the cases that occur are that there is no measuring tool for evaluating information technology governance related to resource governance, performance measurement, governance of the use of SIAK and service governance. So that an Information Technology Governance governance control mechanism is needed using the COBIT 4.1 Framework. An overview of the performance of information governance technology to determine the *scope* of IT governance capabilities in training centers that are currently running, the role of the function of information system auditing must be built by a standard that is already standardized (Ajismanto, 2018). Governance Information technology has a wider scope and concentrates on the performance and transformation of information technology to meet current and future needs from the angle of internal and external (Surendro, 2009).

Procedures for continuous improvement of IT governance, especially in the process of managing data, are expected to minimize the risk of the above threats. To improve information technology governance, an agency or organization must first be able to understand the current level of information technology management and the expected level of information technology management for corrective actions to be effective. Village has the main task of carrying out affairs connected to the Dispendukcapil in the field of population administration using the Klampid system which in processing data must produce accurate information.

Klampid is a system used by officers to enter community data to take care of population needs. Based on this, this study aims to evaluate IT governance in Village which uses the COBIT 5 framework in sub domains that are in accordance with the conditions of the agency and to find out whether Village has met the standards or not. With a method to measure IT governance performance using the COBIT 5 framework in the Deliver, Service and Support (DSS) domain. Information Technology Governance Audit in Village which focuses on the DSS01 and DSS05 domains which covers the areas of implementation and security of services in the IT system and its results, as well as support processes that allow the implementation of this IT system to be effective and efficient. The expected result of this study is to evaluate the current state of IT governance and recommendations for future improvement, using maturity calculations that measure the level of security maturity of filing documents to meet business objectives. The stages carried out in starting the research are conducting interviews and observations (Pasha et al., 2020).

RESEARCH METHODS

In this research, several methods will be carried out in data collection, namely observations, interviews, literature reviews, and documentation. In carrying out the research, the following stages will be used:

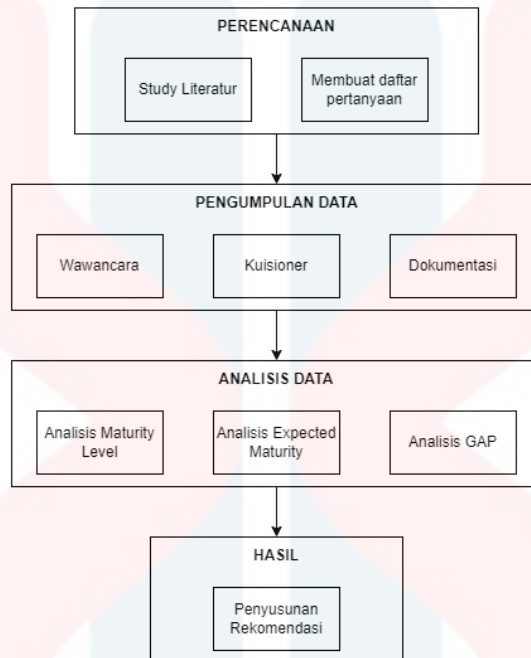

Figure 1. Stages of Research

Planning

At this stage the author conducts a literature study by looking for references from several previous studies and books from COBIT 5 itself. After that, the author determines the problem and also the sub domains that are suitable for solving the problem. After that, conduct the preparation of a questionnaire with several statements in accordance with the sub-domain used to be submitted to several village staff in the population service section. This questionnaire was created with a linear scale model from 1 (strongly disagree) to 5 (strongly agree).

Data Collection

Data collection is carried out directly by visiting Village to make observations. After that, conducted an interview by asking some questions to the Head of the Government and Public Services section and also gave a questionnaire containing several statements from the selected sub-domain to the population service staff.

Data Analysis

Data analysis was carried out by calculating the Maturity Level, Expected Maturity, and GAP. The calculation is based on the results of a questionnaire distributed to employees of Kelyourahan, by calculating the answers of each respondent multiplied by the weight of each answer sought to get the total number of questions. Then the value is divided into the recommended answer options using an index scale of six answers that represent the maturity level of COBIT (levels 0-5). The formula for calculating its maturity value is:

$$\text{Nilai Maturity} = \frac{\sum (\text{jawaban} \times \text{bobot})}{\sum \text{pertanyaan}}$$

The maturity model used for the management and governance of IT processes is based on the organization's assessment methodology and can be assessed from none (0) to optimistic levels. The maturity model aims to find out the existence of existing problems and set priorities for improvement. The size of the COBIT Maturity Index can be seen in Table 1 below.

Table 1. Maturity Level

Tingkat Kematangan	Skala Pengukuran
Skala 0 – Non Existent	0,00 – 0,50
Skala 1 – Initial/Ad Hoc	0,51 – 1,50
Skala 2 – Repeatable but Intuitive	1,51 – 2,50
Skala 3 – Defined	2,51 – 3,50
Skala 4 – Managed and Measurable	3,51 – 4,50
Skala 5 – Optimised	4,51 – 5,00

Expected Maturity is the expected level of maturity, and will later be used as a benchmark in the service process. GAP is the difference between the result of Current Maturity and Expected Maturity. Where if a high GAP value is found, it means that the company or organization must evaluate the section so that the maturity level can reach Expected Maturity.

Results

Make several recommendations or suggestions to Village from the results that have been obtained to improve population services so that the implementation of this IT system is more effective and efficient.

RESULTS AND DISCUSSION

In this chapter, we will discuss the results of research on the sales system at the SY Jaya Glassware Shop in Blogmundu Village, Umbulsari, Jember Regency. The results of this study include identification of needs, system design, program creation, and system testing.

Needs Identification Results

In the Population service in Village where the service system is currently carried out online using the Klampid website. Data obtained from observation, interviews and distribution of questionnaire questionnaires to residents, then the author calculates the Maturity Level by summing the answer results divided by the number of questions. Getresults like the following:

Table 2 Maturity Level calculation results

DOMAIN	SUB DOMAIN	DESKRIPSI	CURRENT MATURITY	KETERANGAN
DSS01	DSS01.01	Perform operational procedures.	4,75	5 – Optimised
	DSS01.02	Manage outsourced IT services.	4,75	5 – Optimised
	DSS01.03	Monitor IT infrastructure.	4,33	4 – Managed and Measurable
	DSS01.04	Manage the environment.	4,75	5 – Optimised
	DSS01.05	Manage facilities.	4,27	4 – Managed and Measurable
DSS05	DSS05.01	Protect against malware.	2,67	3 – Defined
	DSS05.02	Manage network and connectivity security	3,89	4 – Managed and

				Measurable
	DSS05.03	Manage endpoint security.	4,55	5 – Optimised
	DSS05.04	Manage user identity and logical access.	4,75	5 – Optimised
	DSS05.05	Manage physical access to IT assets.	3,86	4 – Managed and Measurable
	DSS05.06	Manage sensitive documents and output devices.	4,4	4 – Managed and Measurable
	DSS05.07	Monitor the infrastructure for security-related events.	4,6	5 – Optimised
TOTAL RATA – RATA			4,3	

Then conduct an analysis of Expected Maturity and GAP / difference. Expected Maturity itself is the desired level of expectation, here the author determines the expectation level, which is 5. GAP is the difference in value between Expected Maturity and Current Maturity, and the results are obtained as follows:

Table 3. Expected Maturity and GAP Analysis

SUB DOMAIN	MATURITY LEVEL		
	CURRENT MATURITY	EXPECTED MATURITY	GAP/SELISIH
DSS01.01	4,75	5	0,25
DSS01.02	4,75	5	0,25
DSS01.03	4,33	5	0,77
DSS01.04	4,75	5	0,25
DSS01.05	4,27	5	0,73
DSS05.01	2,67	5	2,33
DSS05.02	3,89	5	1,11
DSS05.03	4,55	5	0,45
DSS05.04	4,75	5	0,25
DSS05.05	3,86	5	1,14
DSS05.06	4,4	5	0,6
DSS05.07	4,6	5	0,4
TOTAL RATA – RATA			0,66

CONCLUSIONS

The results of the evaluation of this study have obtained findings, namely that the GAP in the DSS domain is in line with expectations, except for the security system which is still quite appropriate. Because the DSS05 domain has the gap value farthest from the expectation level, which is 2.33. This is because Village is only an executor of the system that has been created by the Central Government so Village only applies and performs according to the standards set by the central government. This shows that the problem faced in the management of information technology in Village is found in the DSS domain, namely DSS05 in the part of the lack of security of system devices. Meanwhile, the DSS01 domain has the closest value to the expectation level, which is 4.75. This proves that the system on services in Village is very good.

BIBLIOGRAPHY

- Apriyansyah, Unik, M., & Mukhtar, H. (2020). Implementasi Sistem Keamanan Pesan Text Dengan Teknik Steganografi Menggunakan Metode Least Significant Bit (LSB). *Jurnal Computer Science and Information Technology (CoSciTech)*, 1(1), 8–12.
- Handoyo, E. (2020). Analisis Tingkat Keamanan Informasi: Studi Komparasi Framework Cobit 5 Subdomain Manage Security Services (DSS05) dan NIST SP 800-55. *Jurnal Computer Science and Information Technology (CoSciTech)*, 3(2), 1–19.
- Imtihan, K., Rodi, M., Ashari, M., Zaen, M. T. A., & Marzuki, K. (2022). Audit Tata Kelola Teknologi Informasi Menggunakan Framework Cobit 4.1. *MATRIK: Jurnal Manajemen, Teknik Informatika Dan Rekayasa Komputer*, 21(2), 267–274. <https://doi.org/10.30812/matrik.v21i2.1569>

- Islamiah, Mega Putri. (2014). Tata Kelola Teknologi Informasi (IT Governance) Menggunakan Framework COBIT 5 (Studi Kasus: Dewan Kehormatan Penyelenggara Pemilu (DKPP))
- Kridanto, Surendro. (2009). Pengembangan Rencana Induk Sistem Informasi. Informatika Bandung
- Pasha, D., thyo Priandika, A. and Indonesian, Y., 2020. Analisis Tata Kelola It Dengan Domain Dss Pada Instansi Xyz Menggunakan Cobit 5. *Jurnal Ilmiah Infrastruktur Teknologi Informasi*, 1(1), pp.7-12.
- Shariff, M. N. (2018). Tata Kelola Penerapan Teknologi Informasi Pengelolaan Pajak Daerah Di Dppkad Kab. Oki Menggunakan Framework Cobit 5. *Seminar Nasional Teknologi Informasi Dan Komunikasi (SEMNASITIK) X*.
<http://conference.binadarma.ac.id/index.php/semnastik/article/view/867>
- Surendro, K. 2009. Implementasi Tata Kelola Teknologi Informasi. Bandung Informatika
- Wella, W., 2016. Audit Sistem Informasi Menggunakan Cobit 5.0 Domain DSS pada PT Erajaya Swasembada, Tbk. *Ultima InfoSys: Jurnal Ilmu Sistem Informasi*, 7(1), pp.38-44.
- Wardani, S. and Puspitasari, M., 2014. Audit tata kelola teknologi informasi menggunakan framework cobit dengan model maturity level (studi kasus fakultas abc). *Jurnal Teknologi*, 7(1), pp.38-46.

Study of Social Life in The Culture of Malay Petalangan in The Digital Era

Hevi Susanti

*Faculty of social and political science, Universitas Riau
Faculty of Language Studies and Human Development, Universiti Malaysia Kelantan,
Bachok, Kelantan 16300, Malaysia
hevi.susanti@lecturer.unri.ac.id & e19e0049f@siswa.umk.edu.my*

Ali Salman

*Faculty of Language Studies and Human Development, University of Kelantan Malaysia
ali salman@umk.edu.my*

Asrinda Amalia

*Faculty of Language Studies and Human Development, Universiti Malaysia Kelantan,
Bachok, Kelantan 16300, Malaysia
e19e0048f@siswa.umk.edu.my*

Edo Arribe

*Faculty of Computer Science, University of Muhammadiyah Riau
edoarribe@umri.ac.id*

ABSTRACT

Objectives of this study are, Analysis of how the effect of digitalization on the change of Malay culture petalangan pelalawan riau, This research is motivated by the abandonment of the Petangan customs by the Petangan people. This Research This research is a qualitative descriptive study using an ethnographic research type. This research was conducted in the Petalawan community, Kerumutan sub-district, Pelalawan district, Riau. The subjects in this study used snowball sampling and accidental sampling. data collection techniques by observation, interviews and documentation. The data analysis technique in this study refers to the interactive model of Huberman and Miles. The results of research on the social life of the Petalangan Malay community are strongly influenced by digitalization because currently in the social life of the Petalangan community, the tradition of Basolang, which is a hereditary culture carried out by the Petangan Malay community.

Keywords: Malay culture petalangan, sosial life, digital era

INTRODUCTION

The development of technology in the digital direction is currently increasingly rapid. In this digital era, humans in general have a new lifestyle that cannot be separated from all-electronic devices. Technology has become a tool that can help most of human needs. Technology has been used by humans to make it easier to do any task and job. This important role of technology has brought human civilization into the digital era. The digital era has brought various good changes as a positive impact that can be used as well as possible. But at the same time, the digital era also brings many negative impacts, so that it becomes a new challenge in human life in this digital era. Challenges in the digital era have also entered various fields such as politics, economy, socio-culture, defense, security, and information technology itself. Setiawan, Wawan (2017).

The digital era was born with the emergence of digital, internet networks, especially computer information technology. The new media of the digital era has the characteristics of

being able to be manipulated, network or internet. The mass media switch to new media or the internet because there is a cultural shift in the delivery of information. The ability of this digital era media makes it easier for people to receive information faster. With the internet, the mass media have moved in droves.

The more sophisticated digital technology today makes big changes to the world, the birth of various kinds of increasingly advanced digital technology has emerged. Various groups have made it easier to access information through many ways, and can enjoy the facilities of digital technology freely and in control. The digital era has also made the realm of people's privacy seem lost. Personal data recorded in the computer's brain makes internet residents easy to track, both in terms of surfing habits or hobbies. The digital era is not a matter of being ready or not, nor is it an option, but a consequence. Technology will continue to move like ocean currents that continue to run in the midst of human life. So there is no other choice but to master and control technology properly and correctly in order to provide the maximum benefit. Setiawan, Wawan (2017).

The birth of a social networking site, which is a web-based service, allows users to create profiles, view a list of available users, and invite or accept friends to join the site. The connection between mobile devices and internet web pages via "social networks" has become the standard in digital communication. Friendship sites continue to grow MySpace, Facebook, IG, Twitter, Tik-tok, Whatapp and others. The digital revolution is the ability to easily move digital information between media, and to access or distribute it remotely.

Paperless is one of the trends of the digital era where the use of paper becomes less. We do not have to print the photos or documents needed on paper, but in digital form. Digital storage is safer than storing various documents in paper form. Digitizing paper documents into electronic files becomes easier to share, one of which is e-books. With e-books we no longer have to store books that are physically thick and require a large space. With digital files also documents become clearer and more concise which can be opened at any time via computers and mobile phones. Setiawan, Wawan (2017).

The development of various applications spreads along with the production of smart phones with operating systems (OS) which are getting closer to human life which are intended for the convenience and comfort of users. The development of the OS has also penetrated other digital devices such as smart televisions, smart washing machines, smart glasses, smart coffee makers, smart heart rate controllers, and so on. Behind its popularity, the era of digital technology holds various potentials and negative impacts that can harm humans. The ease of all work with various applications and technologies, actually makes a person move less, less physical activity, laziness appears and various diseases such as obesity and so on can appear. Excessive use of social media can backfire which has a negative impact on its users.

As a developing country, digital technology is able to encourage various advancements in Indonesia. In terms of infrastructure and laws that regulate activities on the internet, Indonesia is ready to live in the digital era. Indonesia's readiness in internet connection which is currently getting better in the 4G era with Electronic Information and Transactions (ITE). Indonesian people in general are enthusiastic about adopting a digital life, mainly triggered by internet penetration and the use of smart phones which continues to increase every year. The internet-based digital world makes all the activities of its residents unlimited by space and time. The legal umbrella to regulate all forms of these activities, such as the Electronic Information and Transactions Law (UU ITE) in 2008 continues to be refined. People's personal data needs

to be protected in cyberspace, so parties such as Google or Facebook that have their users' personal data cannot use big data carelessly. Setiawan, Wawan (2017).

There have been many developments in the digital era by Indonesia, including the mass media in Indonesia, changing in conveying information. Online media (internet) in today's era has replaced conventional mass media. Although almost a decade Indonesia has been late in adopting communication technology, especially the internet. However, the digital culture of the Indonesian people is very quick to accept these technological developments. Globally, Indonesia is included in the digital culture that is needed to achieve positive growth in accordance with the progress of the era itself. (Setiawan, Wawan 2017).

The digital world not only offers great opportunities and benefits for the public and business interests. However, it also poses a challenge to all areas of life to improve quality and efficiency in life. The use of various technologies is indeed very easy to live, but the digital lifestyle will increasingly depend on the use of mobile phones and computers. Whatever it is, we should be grateful that all this technology makes it easier, it's just that of course every use requires it to control and control it. Because if we use this technology too much, we ourselves will be harmed, and maybe we will not be able to maximize it. The development of technology is so fast that it penetrates all lines of people's social life, changing the order of social and cultural life. (Setiawan, Wawan 2017).

Cultural development is an important aspect in the development of a civilization. Pranoto (2005: 236), writes that culture undergoes biological processes, experiences periods of birth, development, decline, and even disappearance altogether. Entering the 21st century, efforts to develop culture have become a hot topic of discussion. Especially concerns over the facts that arise as a result of the times in social aspects and human values. Talking about culture in Indonesia, Indonesian culture consists of a diversity of regional cultures that are supported by various ethnic groups. All regional cultures are an integral part of Indonesian culture. Esten (1999: 6), writes that the process of forming Indonesian culture does not go through a centralized process. Several cultural centers and pockets scattered in various regions must be grown and developed in order to foster the creativity of the nation and the cultural resilience of a pluralistic nation.

Therefore, the community must work hand in hand for the development of local culture, this becomes interesting to explore. One of them is the Malay community of Petangan who currently must continue to improve in re-developing a culture that has begun to disappear. In addition to carrying out development activities for Malay culture, the community must be able to communicate and persuade the public in general and the younger generation in particular so that the Malay culture of adventure is not lost by technological developments and modernization.

The cultural diversity in Indonesia is one of the prides of cultural heritage that has been passed down from generation to generation by various tribes and ethnicities. This is a wealth that cannot be underestimated, because culture can be created on the cultural background that exists in society. Culture can be inherited if it is studied and socialized properly to the community, both those who are directly related to that culture and people outside the local culture.

Inheriting and passing down cultural customs to the younger generation is very important because they will be passed on to the next generation. What would happen if one day

our culture perished? The Malay culture that just disappeared from the earth is presumptuous and yellow? If this happens, our nation will become a nation without identity, without identity. Indonesia is a country that has a variety of arts and culture. In preserving culture, community participation should be developed and not only rely on the government. The younger generation who are still aware of and understand the rich culture should make various efforts to inherit it to the recipient generation. (Meilani 2014).

The development of communication technology has brought changes in various aspects of life. The community cannot prevent these changes, including the Malay community. They must accept and use the technology to the best of their ability based on the situation and culture. Mass communication technology, especially new media, is changing rapidly following the flow of modernization and the mass communication industry itself (Che Su Binti Mustaffa & Nan Zakiah Megat Ibrahim, 2014). Therefore, today's society is starting to change their mindset and activities following the needs and uses of developing technology.

In this digital era, many cultural shifts have occurred, for example, in Javanese culture, the younger generation of the Javanese now feels increasingly distant from the superior Javanese culture, which organizes all human behavior so that it can run in harmony and peace. With the abandonment of Javanese culture, what happens is that many young people fall into negative activities, this can arise because Javanese culture that upholds good manners has faded. To anticipate this. Akhir Lusono, S.Sn., MM and Endah Supeni, summarize Javanese culture in terms of politeness in speaking, acting, dressing and respecting others. By mastering the superstructure, a person will behave and have noble character. when someone has mastered the traditional ceremony, it will have an impact on daily life, because they will know when, where and to whom to be polite. Especially instilling it in the younger generation, because while maintaining Javanese culture means helping to maintain local wisdom and helping to keep Yogyakarta special.

Subsequent research by Noor Efni Salam (2018) which examined the shift in communication practices in the Riau Malay community, the result was that the Riau Malay community carried out more cultural activities in the academic realm such as seminars, discussions and dissemination of discourse through fatwas and statements in the mass media by stakeholders. custom.

Other research (Aditya Revianur 2020) Recent technological advances, such as digital photography, 3D scanners, and augmented reality, provide alternative ideas for preserving cultural heritage, such as buildings, artifacts and structures. The main point of this research is to continue the discourse on the benefits of digitizing preservation at several cultural heritage sites in Semarang. but most of the cultural heritage in Semarang Regency has been lost due to rapid modernization. The author and several local communities concerned with the preservation of cultural heritage created a project to digitize cultural heritage in Semarang to prevent further destruction and promote the importance of cultural heritage sites to the public through digital media.

The presence of new media in the flow of globalization and modernization has indirectly tried to influence the value system of society and the general culture of the Malay community (Ika Destiana, et al in Yusof & Hanafiah, 2015). In the life of the Malay community, it is famous for its value system such as a simple and gentle self-appearance attitude in every activity of action, conversation and intercourse. Attitudes, characters and personalities inherited from the learning process since the children who formed and gave birth

to the Malay community have pure culture and values in their lives (Wan Norhasiah Wan Hussin, 2012). This pure value system has been assimilated with Islamic teachings since ancient times to form the strong identity and identity of the Malay community (Anwar Omar Din, 2008).

Riau Province is one of the provinces with the largest Malay population in Indonesia. Riau population data shows that the population of Riau in 2017 was 7,543,031 people, and the Malays were the largest ethnic group with a composition of 37.74 percent or 3,091,940 people. In addition, the Malay community is also very open to accepting immigrants from other regions. The openness of the Malay community makes them very easy to be influenced by other customs and cultures that blend into their lives. The currents of globalization and modernization which have recently been more intensely hit, it is feared that it will increasingly threaten the existence of the system of values, norms, customs, and culture of the Malay community.

Malay culture is very open to the outside world so that many ethnic groups come, mingle and integrate from generation to generation and give birth to a pluralistic society, according to Riau cultural expert Tenas Effendy. "This plurality causes the Malay community to always be open to all newcomers who then mingle and fuse into the Malay world," In addition, Malay customs also provide an opportunity for anyone to tie kinship ties through a traditional ceremony called "begito", which is claiming to be brothers. One of the openness of the Malay community is the existence of a number of Malay leaders who came from outside, such as the Sultan of Siak who since the 18th century mixed with Arabs to form a hereditary sultanate with the last sultan Sultan Syarif Kasim II who later became a national hero.

However, he admits, the openness of the Malay community has had a negative impact, such as the number of immigrants who do not want to socialize. "Many immigrants do not know themselves and do not want to mingle. Whereas as immigrants they must respect the Malays as those who are visited,". Bondan Kanumoyoso, a Malay researcher from the University of Indonesia, said that since the existence of the Malay people, the people like to have relations with the outside world and have an open nature. "The Malay world has maritime characteristics, namely the sea is the main means of cultural and economic exchange." very strong in Malay culture," As a result of having maritime characteristics a number of port cities of the Malays emerged as local ports that became centers of regional and international maritime trade activities.

Society is a unit of human life that is interconnected with each other continuously bound by habits and shared identity. Community life can be said to be a social system because in society there are elements of a social system. Broadly speaking, the elements of a social system in society are people who depend on each other in a case whole. In this dependence, an integrated group of people is more permanent and stable. As long as each individual in the community group is still interdependent and still has the same and balanced behavior, so long as the elements of the social system carry out their functions. While specifically and in detail, the social system in society is the status, the role of social differences from individuals who are interconnected in a social structure.

Digital developments have made a cultural shift in Riau, especially the Riau Malay ethnic group, which is the largest ethnic population in Riau Province. The total population of Riau in 2020 is 6,394,087 million people, and 3,967,395 people are ethnic Malays. Malaysian archaeologists state based on the latest evidence that the Malay population existed between

55,000 and 65,000 years ago. This statement is supported by research data from Zainuddin (2011) using mitochondrial DNA, which later proves that people on the mainland, the Malay Peninsula and Sumatra, have a common ancestor with the Orang Asli. (Masri, Yunus et al. 2016) This number has not been added to the Malay community living in Pelalawan, Kampar and Indragiri Hulu districts. With more than half of the total population of Riau and inhabiting most of Riau's area, the Malays consider it natural that the governance and governance of Riau is characterized by Malay culture.

The shift in cultural values and habits of the community is one of them caused by technological developments. The development of technology today is very fast and sophisticated, this has become an important component in people's social life. Currently, in conveying information in the form of messages, the communicator has certain goals and objectives. Globalization has a growing influence, it will certainly have a big impact on the social order of society. Starting from the life of urban communities to rural communities. The dissemination of this information has an impact on the abandonment of cultural values and customs for the Indonesian people globally, although of course there are still cultural values and customs that are still intact.

The content of messages through the media in people's daily lives sometimes causes ordinary people to follow and believe the messages conveyed sometimes follow the message (Hamidy, 2015: 21) This is a concern for the traditional Malay Petangan institutions and the people who care about the Petalangan Malay customs. Petalangan Malay traditional institutions and Petalangan Malay traditional stakeholders are worried that the Malay Petangan culture will be abandoned due to the currents of globalization and technology entering through sophisticated communication media.

The Petalangan people are one of the "original" tribes in Riau who live in the Pelalawan Regency. In the past, the Petalangan people fenced their village with "Talang" reeds and it was customary to take water using the reeds, so they were called "Talang Orang", and all of them were called "Petalangan People". The presence of indigenous peoples has always been a social reality. Indigenous peoples do not grow and develop with idealism. Their association is always based on the philosophy of life that they have determined, which is generally characterized by togetherness and kinship. (Syamsi 2012:11-17).

This description is closely related to the Petalangan indigenous people as a community residing in Pelalawan, Riau Province. The Petalangan community is a community group that has historical support and its existence is not in doubt. According to tombo (a genealogy that proves and describes the names of the main figures of the alliance who cleared the forest for the first time, so that in this evidence the location and boundaries of the alliance's territory can be known). They came from Johor by boat, and cleared the forest in their current settlement. They became subjects of the Kampar kingdom which is now better known as Pelalawan. Under the government of the Pelalawan Sultanate, they received recognition of their rights to their forest area (forest land perbatinan less than one thirty), which was led by a customary chief known as inner. The legal protection rights to customary law and customary land in the Petangan communities have gained legitimacy (Tenas Effendi, forest lands in the areas of the Petangan communities, seminar paper, Pekanbaru 1998, page 4) . This right is proven by the issuance of a certificate of land forest (grand sultan) for indigenous peoples who own Tombo or Terombo.

Outside culture that enters through the media causes the adventurer community to forget and leave their identity as a very cultured adventurer community and upholds traditional values in the social life of the community. (Hamidy, 2015:23) Coupled with the increasingly rapid progress of transportation flows, then followed by transmigration that has occurred in Riau where people outside Sumatra have moved to Sumatra, one of which has moved to the Pelalawan district of course this will bring changes in the social system of the migrant community. . One thing that cannot be left out is that the field community is open and gladly accepts people who come from outside the field of expertise to live and settle in the area of petangan. (Hamidy, 2015:27).

It can be said that the Malay community of adventure in Pelalawan district is still lacking in socializing customary values to the community, this has resulted in weak knowledge of the customs of adventure coupled with freedom of the press and electronic media as well as print media that are under the auspices of communication media to conveying these messages and messages sometimes contradicts the traditional values themselves, such as: blaspheming leaders and anarchic actions that are often broadcast on television, social media and digital media in general. (Hamidy, 2015:31).

At this time, communicating, persuading and socializing the petalangan customs is the joint task of the community, customary holders, ninik mamak and Petangan Malay traditional institutions as well as the petalangan community who care about customs. So that the values of traditional life in the form of morals, behavior, etiquette, manners and others are maintained and will become the basic values of the life of the adventure community that cannot be separated between customs and social values of the community. In the customary language it is said, "Like black eyes and white eyes" it means that the social life of the community is very close to traditional values. (Syamsi 2012:7)

METHODS

This research is a qualitative research that seeks to provide an overview of the situation that occurs, known as descriptive research. Descriptive research is research that provides a systematic description of the facts or characteristics of a particular population in a factual and accurate manner (Rakhmat, 2004:25). Definitively, Kirk and Miller define that qualitative research is a particular tradition in science that fundamentally depends on human observations both in its area and in its terminology (in Moleong, 2005:4).

Denzin and Lincoln (in Moleong, 2005:5) state that: "qualitative research is research that uses a natural setting, with the intention of interpreting phenomena that occur and is carried out by involving various existing methods." According to Jane Richie, there are several advantages to using qualitative research. These advantages can be felt seeing social reality, and its perspective in the world, in terms of concepts, behaviors, perceptions, about the human being studied (in Moleong, 2005:6). In general, this research is to describe and understand the problem as a whole. In this case, the researcher tries to describe the actual situation of how the ethnographic study of the social life of the Malay community goes to Pelalawan by collecting data and information in the field.

Types of Research, This type of research is an ethnographic study. An ethnographic study has a specificity that does not exist in other types of qualitative research, such as case studies, phenomenology, ethnomethodology, text studies, and character studies. One of the advantages is a very deep description of the cultural portrait of a community group, because

the data acquisition process is very long so that adequate data is obtained. In addition, a deep understanding of ethnographic studies will increase knowledge of the origins and value of the characteristics of qualitative research.

Ethnography emphasizes the meaning (meaning) of an event rather than the truth (truth) for the subject. Over time, a number of theories and methods of ethnographic studies have continued to develop, including appropriate concepts and approaches to describe social groups such as motorcycle-riding (gang) groups, juvenile delinquents, social situations such as in classrooms, courtrooms, and also public spaces such as in street corners, terminals, stations, markets, hospitals and so on.

DISCUSSION

Ethnographic Studies

Communication ethnography is a study of the communication patterns of a cultural community. On a macro level, this study is part of ethnography. The term ethnography comes from the words *ethno* (nation) and *graphy* (to describe), so ethnography in question is an attempt to describe culture or aspects of culture (Spradley, 2011:13). Ethnography is a writer's activity to understand how people interact and work together through the observed phenomena of everyday life. In other words, the writer is directly involved with the object of writing in making meaning or interpretation of the writing done.

Subjective meaning is constructed through human cognitive processes. Meanwhile, the meaning of consensus is constructed through processes of social interaction. The two meanings are essentially meanings that indicate social reality. The assumption is that reality is socially constructed through the words, symbols, and behaviors of its members (Liliweri, 2003: 134).

Ethnography of communication is an early approach and framework for analyzing the basic unit of sociolinguistics-communicative events (Giglioli, 1972: 20). The term ethnography of communication (*ethnography of communication*) is a development of the ethnography of language (*ethnography of speaking*). The six scopes of communication ethnographic studies according to Hymes (Syukur in Kuswarno, 2008: 14), namely:

1. Patterns and functions of communication (*patterns and functions of communication*)
2. (*nature and definition of speech community*)
3. Ways of communication (means of communication). communicative competence)
4. Components of competence communicative (component of communicative competence)
5. Relationship of language with world view and social organization (relationship of language to world view and social organization)
6. Universe and linguistic and social inequalities (linguistic and social universals and inequalities)

Ethnography of communication uses ethnography as a basis and communication as a range and type of complexity (Hymes in Sumarsono, 2012: 311). Communication ethnography wants to add speech or communication as topics worked by anthropologists to their ethnographic descriptions, and develop linguistic work - by linking the structure of linguistic components to how speakers use these structures (Sumarsono, 2012: 311). Ethnography of communication explains communicative competencies such as rules for communicating, mutually recognized rules for interaction, cultural and knowledge rules as the basis for interaction, context, and content of communication events and the interaction process. The focus is on what speakers need to know to communicate properly in a particular speech community and how speakers learn; how communication in the speech community is patterned

and organized as a system of communicative events; and how these communicative event systems interact with other cultural systems.

Communication ethnography helps researchers find valuable information on the language behavior of people in a community. Communicative events can provide motivation for speakers to choose certain linguistic choices in interaction (Sumarsono, 2012: 314). Ethnography of communication is research based on ethnography and communication. This study tries to describe the use of language in the context of certain situations, so that it can be clearly observed patterns of speech activity that cannot be separated from grammar (as is done by linguists), about personality (such as psychology), about social structures (such as sociology), about culture. (such as anthropology), and so on. In this regard, a researcher cannot establish language, or even speech, as a narrow frame of reference. Researchers must take the context of a community (*community*), or network of people, then examine the communication activities as a whole, so that each use of communication channels or codesis always part of the community repertoire that speakers take when needed.

Social Life

Kimball Young and Raymond W. Mack argue that social interaction is the key to all social life, because without social interaction there would be no life together.² Furthermore, John J. Macionis stated that social interaction is a process in which individuals behave and react in relationships with other individuals. Based on this definition, it can be concluded that social interaction is a reciprocal relationship between two or more human individuals, where the ideas, views and behavior of one individual influence, change or improve other individuals, or vice versa. This formulation accurately describes the reciprocal continuity of social interaction between two or more human beings. This reciprocal relationship can take place between individuals and individuals, between individuals and groups, and between groups and groups to achieve a goal.

Social interaction is the basis of social processes, *this understanding refers to dynamic social relationships*. Or in other words, social processes are ways of relating in people's lives that can be seen when individuals and human groups meet each other and determine the systems and forms of these relationships.^{So} when two people meet, social interaction begins when they greet each other, shake hands, talk to each other, or maybean argument occurs with each other. Such activities are examples of other forms of social interaction. Soleman B. Taneko added that the characteristics of social interaction include: (1) the presence of two or more actors, (2) the existence of a reciprocal relationship between actors, (3) the process begins with social contact, either directly (primary social contact or primary social contact).), or indirectly (secondary social contact), (4) the existence of time dimensions (past, present, and future) that determinethe nature of the ongoing reciprocal relationship, and (5) the purpose of each actor.

Conditions for Social

Interaction Social interaction does not just happen, but there are certain conditions for social interaction to take place. These conditions are the existence of social contact and communication. Social Contact Social contact is a direct social relationship between individuals, such as by touch, conversation, or face to face. However, in this modern era, social contact can occur indirectly. For example, people can communicate with each other by telephone, telegraph,radio, letters, and so on. These technological devices do not require a physical relationship to realize a social interaction, so it can be said that physical relationships do not need to be the main requirement for social contact.

Customs

Adat is the core or nucleus of Malay civilization or civilization. It can be interpreted that this custom in Malay culture has existed since Malay humans existed. Adat is always associated with how humans manage themselves, groups, and human relationships with nature (both real and supernatural or supernatural), and human relationships with the Creator. Thus, adat has a meaning that is "synonymous" with culture.

According to (bin Jilin Syahrial) Customs are regulations that are implemented (practiced) from generation to generation in a society, so that they become laws and regulations that must be obeyed. Meanwhile, customs are rules or ways of doing things that are accepted as customs. Customs and customs have a close relationship, and are seen as a tool that seeks to regulate people's lives, the goal of which is to achieve prosperity and harmony in life. Customs shape culture, which then elevates the dignity of the people who practice it. Human groups are also forced to compile a social and cultural system that regulates their relationship in the context of responding to nature as a source of earning their living. Without this effort to act together and systematically arranged, humans will face life problems. Therefore, behaviors that become habits emerge, and sociological relationships in the form of groupings. All of this gave birth to norms, customs, and laws to guard, regulate, and harmonize the power of all individuals involved in the activities of these human community groups.

The importance of adat in the life of the Malay community is that it functions to regulate almost all aspects of life, providing direction and foundation in all activities, from the big things to the smallest things. Customs teach people to be civilized human beings, polite, tolerant, respectful, self-aware, mutual help-in order to create an atmosphere of harmony and peace in the life of society, nation and state. In addition, Malay customs originate and refer to Islamic teachings. Therefore, adat is used as the identity of every Malay person. In accordance with the teachings of Malay customs, if you want to know the glory of the people, look at their customs, language shows the nation, customs show the people.

Four categories of Malay customs

In order to determine the policy and direction of Malay civilization, the Malay community bases it on a generic institution called *adat*. In order to face and fill globalization, the Malay community has made its cultural strategy. This strategy is directed in Malay custom. Malay custom is based on the teachings of Islam, which is conceptualized as *adat bersendikan syarak — and syarak bersendikan kitabullah*. What is meant by Islamic law is Islamic law or *civilization*. On the other hand, *kitabullah* means the Holy Book of Allah (Al- Qur'an), or referring further and deeper is the revelation of Allah as a guide for man in filling his culture.

In carrying out their cultural direction, the Malays decided to apply four areas (variety) of custom. According to Lah Husni (Tondi and Iryani 2018) customs in the Malay ethnic group are included in four types, namely: (1) the actual customs; (2) customary customs; (3) customary customs, and (4) customs. These four areas of custom synergize with each other and go hand in hand in controlling the polarization of Malay culture in general. Whatever the Malays do should be based on these customary teachings.

Petalangan Community Culture

People live in Pelalawan Regency, Riau province. The residential villages of the Petalangan people are located about 60-95 kilometers from the city of Pekanbaru. Most Petalangan people make a living from rubber forests, palm oil and as fishermen. The term Petalangan comes from the word gutter, which is a type of bamboo. This tribe also refers to themselves as land people.

According to tombo, the Petalangan people came from Johor by boat, and cleared the forest in their current settlement. They later became subjects of the Kampar Kingdom, and then Pelalawan. Under the government of the Sultanate of Pelalawan they received recognition of the rights to their forest area (Forest Land Perbatinan Less Satu Thirty), which was led by a customary chief known as the inner. Petalangan people sell forestproducts and services to the Pelalawan Sultanate. With the independence of Indonesia, the life of the Petalangan people underwent a change. The Pelalawan Sultanate was incorporated into the Republic of Indonesia, and the traditional government by the inner was replaced by a village head appointed by the Republican government.

In the adat of the Petalangan, marriage between members of a matrilineal clan (tribe) is prohibited. The recommended marriage is the so-called return to bako. On returning to the bako a man marries the daughter of his maternal uncle. A married man lives in a house near his wife's parents. Although marriage between members of the same clan is prohibited, the Petalangan people prefer marriage to people from the same village (endogamy).

Ninik-mamak plays an important role in planning a wedding. The male ninik-mamak submit an application to the female family, which is then followed by negotiations with the female ninik-mamak. They then decide the time and place of the wedding celebration. The Petalangan tribe adheres to Islam. But they also have their own belief system, which assumes the presence of spirits in animals and plants. However, this belief is not considered contrary to Islam. The Petalangan people use the Minang dialect. Indonesian is sometimes used by village heads or to communicate with outsiders. Other adjacent languages and dialects that influence are: Pelalawan, V Koto Kampar, Kuantan and Minangkabau. The literary forms known to the Petalangan people include traditional speech (capable of adat), rhymes, and long singing, mantras (monto), belian, and tasting.

Every society has a system. The importance of the system is absolute. Because, if a community system is not formed, there will be clashes of duties and interests among fellow citizens. It is inconceivable how a society if it does not have a system, then with the existing system, the pattern of relations between citizens can be arranged in a social structure or arrangement. In a similar concept, we can also see how the community system is in the field. In the past the field area was under the auspices of the Pelalawan Kingdom (Hamidy 1983).

In building a good relationship pattern, the field community also places the ulama as one of the most important positions in society. This is not surprising, in the Petangan community, although adat has regulated the relationship between human beings so that it can be harmonious, the value system is still seen as imperfect. All human actions are essentially not always right, because what is made and regulated by humans is not eternal. Customary leaders are aware that only the values of religion and the word of Allah SWT are eternal in their truth. Customs and Islamic religion have become interrelated values in the life of the field community (Hamidy 2004).

New media and digital media

The new media era is marked by what is called media convergence. Structurally, media convergence means the integration of three aspects, namely telecommunications, data communication, and mass communication in one medium (Jan Van Dijk, 2006:7 in Nasrullah, 2014:15). In new media, the audience has the authority to construct the text and use the medium. New media also gives audiences the freedom to transform themselves to take advantage of other audiences.

Computer Mediated Communication (CMC)

One aspect that has emerged from the development of new media that brings together individuals or groups in the virtual in communicating is computer-mediated communication. Computers, mobile phones or other connected devices are basically not just media that mediate the distribution and circulation of messages, but also as a medium like aspects and environments in face-to-face communication. It's just that communication that occurs in cyber media depends more on text, both text in the real sense and symbols, icons, or other markers that represent the intent of the message. (Nasrullah, 2014:79).

The real form of the new media is: the internet. The internet can be accessed through various media, for example: mobile phones, and computers. Through the internet network, everyone can be connected anywhere, anytime and in any way. New media technology also provides a lot of convenience and efficiency in terms of budget. Many people no longer feel they have to spend a lot of money to be able to meet (red: communicate) with people in any part of the world. Flew (2005) defines new media with a terminology to describe the convergence between digital communication technologies that are computerized and connected to the network. The ability of the internet to be able to connect everyone in such a large and wide network was unthinkable before the presence of this new media.

One type of new media that is very popular among the world community today is Social Media. Social media has even become a source of reference for many people when they want to know any information that is happening around the world. The rapid flow of information makes the position of social media today so important. Many policies and decisions in an organization are communicated through social media. The rapid flow of information through social media requires good skills from its users. Because through social media various frauds, drug trafficking, trafficking, hoaxes and other criminal crimes threaten everyone who uses social media. Kotler & Keller (2012) define social media as a means for consumers to share text, image, video and audio information with each other and with companies and vice versa. This social media is in the form of a web-based social networking site. In almost all over the world, people are very fond of social media, and Indonesia is no exception.

CONCLUSION

Research study of social life ethnography in the malay community of Petalawan Pelalawan in the digital era In regulating the social life of the petalangan community in the Kerumutan sub-district, Pelalawan Regency, by using customary socialization and customary seminars, it is something that is carried out by traditional stakeholders, the government and the customary institutions of the Petalawang which is one way to revive customary values and customary law. In addition, the supporting strategy is psychodynamic, the strategy used is a sociocultural persuasive strategy where family and environmental factors also greatly influence the audience and society to participate in maintaining the customs and culture of the field. Furthermore, the meaning construction strategy where through this strategy is centered that knowledge can change behavior, through parables in explaining something which essentially makes it easier for the audience to understand the real meaning. The persuasive communication strategy was very well responded to by the Petangan community and supported in reviving customary law and customary values in maintaining and preserving Petangan customs.

The role of community leaders in regulating the social life of the Petangan community in the Kerumutan District, Pelalawan Regency. In this study, the researcher concluded that the role of community leaders was still lacking in terms of socialization and only some people

really knew about the customs of adventure. In this study, the role of community leaders plays a role when problems arise in the community and there are no efforts and initiatives to prevent them at this time.

REFERENCES

- Abdullah, M. W. (2006). *Sosiologi SMP/MTs Kls IX (KTSP)*, Grasindo.
- Abrar, M., et al. (2018). "" If our English isn't a language, what is it?" Indonesian EFL Student Teachers' Challenges Speaking English." *The Qualitative Report* 23(1): 129-145.
- Cipresso, P., et al. (2018). "The past, present, and future of virtual and augmented reality research: a network and cluster analysis of the literature." *Frontiers in psychology*: 2086.
- Fahmi, F., et al. (2019). Design of hardware module for the vehicle condition monitoring system based on the internet of things. *IOP Conference Series: Materials Science and Engineering*, IOP Publishing.
- Hamidy, U. (1983). *Riau sebagai pusat bahasa dan kebudayaan Melayu*, Bumi Pustaka.
- Hamidy, U. (2004). *Jagad Melayu dalam lintasan budaya di Riau*, Bilik Kreatif Press.
- Harkness, J. A., et al. (2003). *Cross-cultural survey methods*, Wiley-Interscience Hoboken, NJ.
- Hidayat, H., et al. (2011). "Discharge estimation in a backwater affected meandering river." *Hydrology and earth system sciences* 15(8): 2717-2728.
- Kholil, A. (2020). The analysis of thermal performance of vernacular building envelopes in tropical high lands using Ecotect. *IOP Conference Series: Earth and Environmental Science*, IOP Publishing.
- Liliweri, A. (2010). *Komunikasi serba ada serba makna*, Kencana.
- Liliweri, A. (2010). *Strategi komunikasi masyarakat, Lkis Pelangi Aksara*.
- Setiawan, D. (2018). "Dampak Perkembangan Teknologi Informasi dan Komunikasi Terhadap Budaya." *JURNAL SIMBOLIKA: Research and Learning in Communication Study*
- Spradley, J. P. (2016). *The ethnographic interview*, Waveland Press.
- Syamsi, I. (2021). "Pengambilan keputusan dan sistem informasi."
- Walker, R. M., et al. (2011). "Exploring the diffusion of innovation among high and low innovativeness localities: A test of the Berry and Berry model." *Public Management Review* 13(1): 95- 125. bin Jilin Syahril, M. T. "Adat dalam Peradaban Melayu."
- Bungin, B. (2013). "Metodologi Penelitian Sosial & ekonomi: Format-format kuantitatif dan Kualitatif untuk studi sosiologi, kebijakan publik, komunikasi, manajemen, dan pemasaran."
- Cui, W. (2019). "Rhetorical Listening Pedagogy: Promoting Communication Across Cultural and Societal Groups with Video Narrative." *Computers and Composition* 54: 102517.
- This article explores the means of applying Krista Ratcliffe's theory of rhetorical listening into composing and interpreting multimodal texts to facilitate and promote communication across genders, cultures, and classes; especially between privileged classes and marginalized groups. New technologies and media channels have especially changed the ways we communicate and the ways we approach composition classrooms. Digital technologies and multiple modes provide rich rhetorical possibilities for making meanings and articulating our voices effectively. However, these voices cannot be heard if audiences/listeners do not devote effort to rhetorically listen. In this article, I elaborate on the theory of rhetorical listening and its strategies—raising awareness of identification, clarifying potential disidentification, and constructing non-identification that can be applied in listening to multimodal texts for cross-cultural communication.

Finally, this paper suggests using rhetorical listening pedagogy in composition classrooms; and illustrates how the theory of rhetorical listening can be applied in multimodal composition teaching to enrich students' multimodal experiences as well as help them promote cross-cultural communications.

Dedi, M. (2005). "Ilmu komunikasi suatu pengantar." Bandung: Remaja Rosdakarya.

Dedi, M. (2005). *Komunikasi Efektif*, Bandung: PT. Remaja Rosdakarya.

Efendi, T. (2015). "makalah yang disampaikan pada acara Seminar Internasional Menggali Akar Melayu." *Melayu sebagai akar Tradisi Nusantara (Strategi Politik dalam Menciptakan Budaya Melayu Palembang Emas*.

Fahmi, F., et al. (2019). Design of hardware module for the vehicle condition monitoring system based on the internet of things. *IOP Conference Series: Materials Science and Engineering*, IOP Publishing.



The Success of Community Leadership in Reducing Poverty: A Focus Group Analysis

Ahmad Aizuddin Md Rami
Faculty of Educational Studies
Universiti Putra Malaysia
ah.aizuddin@gmail.com

Mohd Faiq Abd Aziz
Faculty of Educational Studies
Universiti Putra Malaysia
mohdfaiq@upm.edu.my

ABSTRACT

The leadership capabilities of authorities in charge of rural areas in Malaysia is unclear as a whole, and there exists no consensus explaining the characteristics of credible rural community leaders, nor their success in reducing poverty. Malaysia still lacks research on community leadership in rural areas, thus more specific and in-depth research is needed. Based on the above premises, a study was carried out with the aim of deepening the leadership experience by explaining the leadership factors affecting the success rates developing rural areas and reducing poverty. To obtain in-depth information, the current study used a qualitative approach, with a focus group discussion method, comprising of ten informants from the community's leaders. Thematic analysis was used to explore in-depth the aspects that contribute to a rural community leader's success in poverty reduction exercises. The findings revealed that the appointed local leaders had strong, dynamic decision-making skills, a community safety environmental plan, leadership qualities, and they provided leadership training and networking opportunities to youths within their community to eliminate social and economic poverty.

Keywords: *Community development, poverty, rural community, community leadership*

INTRODUCTION

A rural community is a community within society that is filled with culture and has a unique way of life. The rural community of Malaysia has been the most important community since Malaysia's independence. Various facilities are enjoyed by the rural community in terms of economy, social factors, infrastructure, and education, and the overall knowledge of the community has improved in line with the progress achieved by the country (Rami et al., 2020). The development of these rural communities involves the process of reorganizing and reorienting economic and societal systems (Freddie et al., 2013). This means that development not only involves an increase in income and means of production, but also takes into account changes in social institutions, administrative structures, public opinion, customs, and beliefs (Syed Husin, 1982). The progress made by rural communities can be measured or demonstrated by the eradication of poverty (Ricketts, 2008), the reduction in total unemployment (Wendy, 2013), as well as a closing in the equality gap (Rami et al., 2019). Community development through economic, social, and educational activities in rural areas is seen to help the communities involved by teaching them to be independent and fostering a high sense of identity and cooperation with one another (Rami et al., 2021)

Society, at this point, is constantly faced with new challenges and environments that demand that every leader actively formulate varying strategies to achieve organizational goals

(Garret et al., 2017). The challenges of increasingly complex rural communities require proactive, far-sighted leadership, and the ability to address a wide range of issues in their communities (Worthy et al., 2016). The challenges facing rural communities require leaders who are able to transform their communities into excellent communities. Rural communities and rural leaders need to liaise closely with government agencies, administrative offices, politicians, and even private agencies to seek cooperation in developing their communities. Leaders in rural communities need to identify the specific needs of their community members. In addition to that, they need to identify existing strengths that can be used as a source of economic and social improvement within the community. Therefore, the leadership committee at the rural community level is seen as being very important to the country, thus leading to governmental efforts being made to improve the socio-economic status of rural communities.

LITERATURE REVIEW

According to Davenport & Mattson (2018), a leader is an individual who leads and initiates every action in an organization. Bennis & Nanus (1985) states that leaders are influential individuals, able to unite all efforts towards achieving specific goals. In the context of society in Malaysia, community leaders consist of formal leaders and informal leaders. Each of these categories of leaders is highly respected and admired by the community, and becomes a reference expert and advisor in related matters (Syed Husin Ali, 1982). Formal leaders consist of individuals appointed by the government, such as *penghulu*, Chairmen of the Village Development and Security Committee (JPKK), *imams*, *bilals*, and youth leaders (Rami et al., 2016)

The responsibilities of a community leader will not be fulfilled unless there is coordination and cooperation between the relevant parties, including those in the government and private sectors, especially when concerning the poverty eradication agenda. In the tradition of democratic representation, representatives of the elected community leaders have to make decisions on behalf of their community members. A leader always plays an important role in their community in the way they manage and carry out the responsibilities that have been entrusted to them by those who have elected them as their representative (Ricketts & Ladewing 2008).

As Ricketts and Ladwing (2008) emphasizes, factors that need to be in place in order to develop good community leadership include:

- i. Human resources
- ii. Responsibilities and expectations
- iii. Finances and resources
- iv. Decisions being made at the community level
- v. Support, cooperation, and communication between communities.

The characteristics of community leadership have been discussed by some researchers and experts (Kirk & Shutte, 2004; Wendy, 2013). They noted that community leadership emphasizes collaboration, continuity, and influencing processes based on relationships between specific people. In the last twenty years, there has been some research conducted focusing on leadership agencies in the leadership process. Some individuals have disputed the importance and role of leadership, claiming it to be considerably trivial and insignificant in providing any benefits to the community. However, scholars are convinced that a leader is the first person to initiate a change (Maharjan, 2017). Thus, community leaders are the ones who need to start the steps towards progressing their community (Musitha, 2020).

METHODOLOGY

This study adopted a qualitative approach to collecting data via focus group discussions (FGDs). FGD is often used as an experimental technique, and as a source of data collection. FGD is considered a planned form of discussion, and the ideal number of informants is at least four and no more than twenty (Creswell, 2018). FGDs can range from being highly structured to unstructured, depending on the purpose of the research. A team composed of professional moderators and assistants is needed to conduct focus group discussions; not only by managing existing partnerships, but also by creating a relaxed and pleasant atmosphere for inexperienced participants. Similarly, the role of the assistants include observing the impact of nonverbal interactions and group dynamics, recording the general content of the debate, and supplementing details (Rami et al., 2021). In this study, semi-structured questions were provided to facilitate discussions. The questions were about the informants' understanding of how a successful leader may aid poverty reduction in rural communities, especially at the grassroots level.

All participants were specifically selected. The sample of the FGD for this study involved a group of ten JPKK leaders. All informants were members of the JPKK committee representing the local communities in a rural area of Terengganu. All FGDs were conducted online using the Zoom meeting platform. A single moderator was used for all focus groups, accompanied by either one or two assistant moderators. The interviews were audiotaped.

Table 1: Demographic profile of participants.

No.	Pseudonym	Employment	Years of leadership experience
1	Yusof	Self-employed	15
2	Hamid	Public officer	10
3	Halimi	Public officer	5
4	Rahmah	Entrepreneur	7
5	Maznah	Housewife	7
6	Roslan	Government Officer	7
7	Mohd	Government pensioner	3
8	Akmal	Entrepreneur	3
9	Jusoh	Farmer	8
10	Zaid	Self-employed	3

RESULTS

Emerging themes

Through the FGD interviews conducted, our researchers identified several important themes that were consistently raised throughout the study. The methods of eradicating poverty at a grassroots level, as consistently proposed by the selected leaders of the rural community, may be summarized as follows:

Dynamic decision-making skills

Unanimous agreement is often difficult to achieve, so the JPKK Chairman, as its main leader, must make a decision based on the various viewpoints and judgments heard. There is a crucial need for them to be able to identify what is best for the community without being dominated by personal or political interests. This often leads to the JPKK Chairman facing dilemmas, which require firm and creative decision-making skills.

“...As a leader, sometimes it is difficult to make decisions... there are many things to think about... When we make a decision, sometimes people don't like the decision. . . ”

The speed and accuracy required when making decisions is essential. Nevertheless, there are still mistakes being made due to lack of experience in related matters. However, they acknowledge that similar mistakes are rare, for the reason that they have taken their previous errors in judgement into account when facing new dilemmas. They strive to ensure perfection while carrying out their duties, as is the work practice of the JPKK. In monthly JPKK meetings, the Chairman often reminds members to always be sensitive to the situation around them, so that nothing is overlooked.

Ricketts (2008), believes that it is important for community leaders to make quick decisions and prioritize the interests of community members in every decision being made. Members of the community need to hear relevant information quickly, in detail, and accurately regarding the decisions being taken by their leaders. Here, experience, skill, and knowledge are important to a leader because decisions need to be made with due consideration. Every piece of information is key in making good decisions, as well as being able to solve every problem that arises. It is also the key to more active involvement.

Community safety environmental plan

Maslow's (1954) Hierarchy of Needs has explained that there are five levels of needs that human beings need to meet, namely physiological needs, safety needs, social needs, self-esteem needs, and self-developmental needs. The need for safety becomes a priority after physiological needs, such as food and shelter, have been met. A safe environment will also motivate people to reach a higher level, which has also been described in transformational leadership. Confidence that a community is in a safe environment adds confidence to the credibility of existing leadership.

The role of maintaining safety and harmony within the local community is part of the responsibility of the Chairman and members of the JPKK committee. In accordance with its name, the Village Development and Security Committee (JPKK) is an entity whose role is to ensure that the village environment is safe for the community to live in. This includes minimizing drugs, theft, youth social problems, the presence of illegal immigrants, fights, and other acts of incitement aimed at splitting the unity of the population.

To ensure that the environment is always safe and harmonious, the Chairman and members of the JPKK committee have established cooperation with security agencies, such as the police, to strengthen the safety of their area. Through the observations made, the frequency and presence of the police in every event and program organized by the JPKK shows that both parties have established close cooperation with each other. To increase the effectiveness of maintaining the safety of the residents, especially at night, a “*Rukun Tetangga*” Area (KRT) and Voluntary Patrol Scheme (SRS) were established to help maintain peace. Every member of the community is seen to be actively involved in becoming a member of the KRT or SRS in their respective areas. The existence of these registered bodies creates a closer relationship between all parties in order to eradicate negative elements as a whole. The existence of the KRT and SRS also makes it easier for the police to obtain information more quickly.

Leadership qualities

Interviews with informants identified four leadership qualities that make rural leaders successful: (i) self-confidence, (ii) extensive knowledge, (iii) experience, and (iv) accountability.

Self-confidence is key to successful leadership. Making choices when there is ambiguity is unavoidable, and successful leaders need to take responsibility for making decisions that have unpredictable outcomes. One of the participants, Roslan, said:

"...It's really, really important (for a) rural leader to have that confidence.... Community leaders must have a certain degree of confidence in their ability to carry out various tasks for the community..."

In addition to that, the findings revealed that high quality leaders must draw from both knowledge and experience:

"...a leader must always want to learn and equip himself with the latest knowledge in his field. A leader must be aware of the current developments and be able to handle any situation related to it..."

"...in my opinion, a leader needs to have extensive experience in his or her family institution. If this is seen as beautiful, then the leader can carry out his duties as a good leader for the community..."

The results also indicated that the most important qualities of a good leader include taking accountability:

"...Usually, if there is a dispute or disputes over land or pet ownership, the leader should resolve it wisely without making a biased decision. This accountability personality trait is essential to maintaining communal harmony..."

Based on the findings, excellent leaders need to have good communication skills, especially the ability to speak in public. Besides that, communication skills are also essential in carrying out a leader's daily tasks, such as directing, conducting meetings, and building networks with external parties. Communication skills are also seen as necessary in carrying out tasks at the grassroots level.

Provide leadership training and networking opportunities to youths

Higher rates of youth employment and poverty reduction both require the development of skills and leadership. By enhancing access to work, increasing productivity, and supporting long-term economic growth, youth leadership development can help bolster a community out of poverty. Skills can be developed through a variety of situations, which may be categorized as formal, casual, and on-the-job.

"... JPKK organizes many activities such as seminars, workshops to improve the skills of youths and women. This year, there are about 4 programs that have been implemented and 2 online (online)..."

These workshops should assist young people in becoming fully and actively involved in finding job prospects or creating jobs for themselves and their community. The training should be updated to reflect the community's evolving economic and labor market demands and possibilities.

"... There are also youths who give suggestions and the community chairman will contact the relevant agencies such as the District Office, KEMAS, FAMA to provide training. There are also private parties who come to help give us training and exposure..."

In this regard, the community leaders have held various youth re-skilling and up-skilling workshops in their respective areas. Within a year, there are approximately four to eight programs held that focus on youth development in the form of knowledge, skills, and leadership. Youths are also helped to strengthen their connections and relationships with external parties, especially within the industry, so that they have space to become entrepreneurs, skilled workers, and professional workers.

DISCUSSIONS AND CONTRIBUTIONS

The role of community leaders is important in ensuring that the government's agenda to eradicate poverty is continued. As a community leadership institution, JPKK must always strive to help the local community. Dynamic decision-making skills are essential to ensure community leadership remains relevant. In fact, good planning is needed so that rural communities can be managed more systematically. The selection of effective leaders is also important to help manage the community better. In Malaysian society, community leaders are seen as catalysts for improving the living conditions of rural communities. It can be said that the qualitative research performed has helped researchers find answers about community leaders in profound ways. Based on the JPKK leaders' focus group interviews, it can be concluded that leadership experience influences the success of developing rural areas and reducing poverty. Four factors that aid these two goals include dynamic decision-making skills, having a community safety environmental plan, leadership qualities, and being able to provide leadership training and networking opportunities to youths.

CONCLUSION

Poverty eradication has been a major national agenda since Malaysia's independence. Various efforts have been implemented, and are continuing to be implemented, to eradicate poverty in both urban and rural areas. Community leaders play a vital role in ensuring that the government's poverty-eradication objective is carried out. JPKK must continually endeavour to support the local community as a community leadership institution. Dynamic decision-making abilities are required to keep community leadership relevant. Indeed, excellent planning is required for rural communities to be handled more efficiently. The role community leaders play is very significant to this effort. Programs have been implemented at the grassroots level so that the socio-economy of rural populations may be improved. The success of some rural community leaders in Malaysia, who have developed their economy and society in their own way, with the support of the government and private sectors, show that there is the ability within community leaders to become catalysts in eradicating poverty in their respective areas. The appointment of the right community leaders will make the community more competitive and capable.

LIMITATIONS AND FUTURE RESEARCH

This research had two limitations. We only gathered the rural community leaders' views on poverty reduction in the rural community from this. Future research should take into account rural people's perceptions on the traits and success factors of rural leaders in reducing poverty programme in their community. The current study's final restriction was that it corresponded with the Covid-19 epidemic. Future studies are encouraged to research how rural leaders can help and manage their communities to deal with COVID-19.

ACKNOWLEDGEMENT

The authors would like to express their deepest gratitude to the informants who were willing to participate and provide full cooperation.

REFERENCES

Bennis, W., & Nanus, B. (1985). *Leaders: The strategies for taking charge*. New York: Harper Collins.

- Freddie, A., Kim R.C & Copeland.S (2013). Leadership and rural communities. *International Journal of Bussiness, Humanities and Technology*. 3(8), 11-20.
- Flora, C. B., Flora, J., & Fey, S. (2004). *Rural communities: Legacies and change*. Westview Press.
- Garrett, L. E., Spreitzer, G. M., & Bacevice, P. A. (2017). Co-constructing a sense of community at work: The emergence of community in coworking spaces. *Organization Studies*, 38(6), 821–842. doi: 10.1177/0170840616685354
- Kirk, P., & Shutte, A. M. (2004). Community leadership development. *Community Development Journal*, 39(3), 234–251.
- Maharjan, K. L. (2017). Rural community leadership in decentralization. In *Decentralization and rural development in Indonesia* (pp. 99–110). Springer.
- Musitha, M. E. (2020). Perceptions of South Africans on traditional leadership: A case of Limpopo province. *African Identities*, 18(4), 450-454. doi: 10.1080/14725843.2020.1777840
- Rami, A. A. M., Abdullah, R., & Ibrahim, A. (2016). The community leaders as a catalyst for rural community development in the state of Terengganu. *International Journal of Academic Research in Business and Social Sciences*, 6(12), 2222–6990.
- Rami, A. M., Aziz, F., Razali, F., & Ibrahim, A. (2020a). Effective local leadership to a successful council in the state of Terengganu, Malaysia. *International Journal of Advanced Science and Technology*, 29(7 Special Issue), 205-210.
- Rami, A. M., Aziz, F., Razali, F., & Yusof, M. R. (2020b). Leadership and ICTs implementation for rural development. *International Journal of Advanced Science and Technology*, 29(7 Special Issue), 531-535.
- Rami, A. M., Simin, H., Abdullah, R., & Ibrahim, A. (2019). Community leader in enhancing rural economic growth in state of Terengganu, Malaysia. *International Journal of Recent Technology and Engineering*, 8(2 Special Issue 11), 680-684.
- Rami, A. M., Aziz, F., Zaremohzzabieh, Z., & Ibrahim, A. (2021). Assessing the Challenges of Local Leaders in Rural Community Development: A Qualitative Study in Malaysia. *Pertanika Journal of Social Sciences & Humanities*, 29. 1-18. doi: <https://doi.org/10.47836/pjssh.29.S1.01>
- Redmond, S. (2013). *An explorative study on the connection between leadership skills, resilience and social support among youth* [PhD Thesis]. National University of Ireland.
- Ricketts, K.G. and Ladewing, H. (2008). A path analysis of community leadership within viable rural communities in Florida. *Leadership*, 4 (2), 137-157.
- Syed Husin Ali (1982). *Masyarakat dan Pimpinan Kampung di Malaysia*: Kuala Lumpur. Fajar Bakti Sdn Bhd.
- Wendy Jo Young. (2013). Leadership models and community resilience to climate change events: A case study of an Alaskan Bush Village. (Doctoral Thesis). Iowa State University.
- Wituk, S., Warren, M., Heiny, P., Clark, M. J., Power, C., & Meissen, G. (2003). Developing communities of leaders: Outcomes of a statewide initiative. *Journal of Leadership & Organizational Studies*, 9(4), 76–86. doi: 10.1177/107179190300900407
- Worthy, S. L., Tyler-Mackey, C., Dyke, P. H., Monroe, P. A., & Welborn, R. (2016). Turning the Tide on Poverty: Perceptions of leaders and leadership in economically distressed communities. *Turning the Tide on Poverty*, 47(3), 322–340. doi: 10.4324/9781315112909-4.

The Development of E-comic to Increase the Awareness of Obesity Among Children

Methusha a/p Nelia @ Athaven
Universiti Teknikal Malaysia Melaka
Melaka, Malaysia
methushanelia@gmail.com

Muhammad Helmy Bin Emran
Universiti Teknikal Malaysia Melaka
Melaka, Malaysia
muhammad.helmy@utem.edu.my

ABSTRACT

Obesity has reached epidemic proportions in developed countries. The highest prevalence rates of childhood obesity have been observed in developed countries. In 2016, more than 340 million children and adolescents aged 5 to 19 were overweight or obese globally. Childhood obesity is one of the most severe public health challenges of the 21st century. This research was designed to investigate problems with the prevalence of childhood obesity in Malaysia and to assess how well e-comic campaigns can raise awareness of the problem. This project combines traditional digital comics with animation. It is intended to raise obesity awareness among children aged below 12 years old through reading the motion comics. In this project, a survey was conducted to evaluate the effectiveness of the e-comic on awareness of obesity. After reading the e-comic, the majority of kids between the ages of 10 and 12 saw an improvement in their test scores; only three kids saw no change. An e-comic delivery of awareness campaigns is promising. Future studies and improvements shall be made to increase awareness regarding obesity among children.

Keywords: *E-comic; Obesity; Children*

INTRODUCTION

Obesity has reached epidemic proportions in developed countries. The highest prevalence rates of childhood obesity have been observed in developed countries. Globally, the number of overweight children under the age of five is expected to exceed 39 million in 2020 (World Health Organization, 2021). In 2016, more than 340 million children and adolescents aged 5 to 19 were overweight or obese. Childhood obesity is one of the most serious public health challenges of the 21st century. Hence, the project that will be developed is an e-comic about raising awareness of childhood obesity. This project also evaluates the effectiveness of e-comic on awareness of obesity among children. The project's scope is for children to bring awareness of obesity. The predicted outcomes of this project are that children will be more aware of obesity as a result of the e-comic, and that the rate of obesity among children will decrease.

The problem is global and is steadily affecting children's lifestyles. Obese children are more likely to develop into obese adults. Obesity in adults is linked to an increased risk of a number of serious health conditions, including heart disease, type 2 diabetes, and cancer (Centers for Disease Control and Prevention, 2021). However, if children are obese, their obesity and disease risk factors are likely to worsen in adulthood. Obesity in childhood is also related to psychological issues such as anxiety and depression. Moreover, they might also face social problems such as bullying and stigma.

LITERATURE REVIEW

E-comic

E-comic or electronic comic, sometimes referred to as a digital comic, was defined by Aggleton (2019) as a comic book that is published digitally and has a single panel or a sequence of interconnected pictures. The e-comic contains recognisable frames, recognisable symbols like word balloons, and handwritten-style typography that may convey more meaning through its visual form. E-comic covers a lot of digitally published types of comic such as comic book archive, webcomic and webtoon.

Several researcher have been exploring this type of medium to see how it can improve the learning process towards children. Ramadhani (2022) in her study discovered that the students were interested, motivated, and contextualised to learn English via e-comics. Another study by Suri et al. (2021) achieved average validation score of 83.8 when implementing android-based e-comic in learning static fluid concepts. It is worth to explore how e-comic to spread the awareness of obesity among children in this study.

METHODS

Comics are effective visual messages that quickly and succinctly explain a story's meaning. E-comics serve the purpose of clearly defining the understanding process. The benefit of this online-based e-comic is that the content of comic stories can be easily understood because they are connected to everyday life. Children's comprehension of the effects of obesity can be tested, and there are humorous animations that can be used to explain the problem. However, adopting e-comics requires some time because some kids do not own smart-phone or laptops, and kids must first get used to reading e-comic.

This system aimed to create an online comic about childhood obesity. The comic is presented in a 2D animated format to make it interactive and engaging. The user's practices are related to the narrative contents, and this needs to be emphasized. The next page and previous page buttons on the standard user interface allow users to control the system.

Figure 1. A hand-drawn sketch of the storyboard.



This project development includes several multimedia elements, including text, graphics, and animation. First, using the Adobe Indesign tool, the texts, audio, and panel border are created and designed in accordance with the specifications. The e-comic will then include the animation. The project will be exported as an epub file once the layout settings and animation have been completed.

Figure 2. The developed e-comic

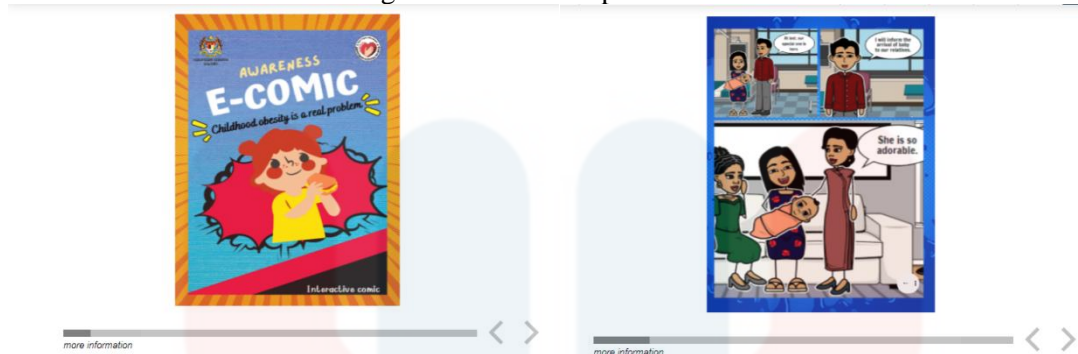

TESTING

The test subjects are children between the ages of 10 and 12 from [Sekolah Jenis Kebangsaan \(T\) Thamboosamy Pillai](#). Twenty users in total participated in the pre-post testing to determine whether the projects intended outcomes materialized.

A platform with web browsing support is needed for the test environment. The Google Form is used to conduct the surveys, which are distributed online. However, in order to read the e-comic, a laptop or PC must have an EPUB reader installed.

The online test will be given using a Google Form. According to their knowledge of childhood obesity, the respondents will initially respond to the pre-test questions. The respondents will then have access to an e-comic on Google Drive for about 10 minutes. The respondents will respond to the post-test questions on the basis of the online comic.

The pre-post testing consists of two parts: pre-testing and post-testing. Based on their knowledge of childhood obesity, users have a set amount of time to respond to the pre-test questions. The users then have access to the e-comic, which they must read before answering the post-test questions. Each testing set contains six multiple-choice questions. Both sets of questions were meant to be equally difficult to ensure data accuracy. The pre-test and post-test results were compared in order to determine the level of awareness of childhood obesity.

Table 1. Pre-post test questions.

No.	Question	Answer
1.	What is obesity?	A. Not being able to walk a mile B. Being severely overweight and having too much of body fat C. Inability to stop eating
2.	Which is not the contributing factor to childhood obesity?	A. Eating patterns B. Physical activity levels C. Doing exercises
3.	What are the health consequences of obesity in childhood?	A. High blood pressure B. Breathing problems C. Stroke D. All the above
4.	Is it unhealthy to be overweight?	A. Yes B. No
5.	What are some solutions to obesity?	A. Special diets B. Weight-management programs

		C. Regular physical activities D. All the above
6.	Obesity may restrict our social life.	A. True B. False

After the testing session was completed, the data was recorded and gathered. The test result and analysis are then conducted after the data is collected in pre-post testing, where the average number of corrected answers is recorded for both the pre-test and post-test.

Table2. Pre-post test data of the respondents.

Respondents	Number of Correct Answer / Total Questions	
	Pre-test	Post-test
1.	1/6	5/6
2.	2/6	5/6
3.	4/6	6/6
4.	2/6	5/6
5.	1/6	4/6
6.	2/6	4/6
7.	4/6	5/6
8.	4/6	6/6
9.	3/6	3/6
10.	4/6	4/6
11.	3/6	5/6
12.	3/6	4/6
13.	2/6	4/6
14.	3/6	4/6
15.	4/6	5/6
16.	5/6	6/6
17.	2/6	4/6
18.	2/6	2/6
19.	3/6	5/6
20.	3/6	6/6
TOTAL	57/120	92/120

The collected data showed the comparison between pre-test and post-test points gained by the respondents. The number of respondents that has been improved in points is 17, while the number of points that remained constant is only 3.

RESULT

According to the analysis, the percentage of average corrected answers for pre-test is 47.5%, while the percentage of corrected answers for post-test is 76.67%. The result explains that the respondents are able to perform better when using the E-comic compared to their prior knowledge. The results showed that awareness delivering using E-comic has higher usability compare to respondent's prior knowledge.

CONCLUSION

This project has a glaring weakness, according to analysis and testing. The entire application must be downloaded before users can start reading the comics because the e-comic can only be read using an epub reader. Reading is also unpleasant due to the inconsistent implementation of the sound effects.

The incorporation of various multimedia elements is the e-main comic's strength. Using graphic, text, and audio elements can increase readers' interest in what they are reading. Additionally, the delivery of the awareness campaign is aided by the use of animation.

However, based on the analysis and user comments, e-comics can be improved in a number of ways. The audio should be used to enhance the reading experience even more, and additional features for the app should include the ability to control the brightness and audio volume. The models, which make up the bulk of the comics, should be polished for better visualization.

The creation of electronic comics can aid in successfully delivering an awareness campaign. With the help of engaging animated comics, reading-impaired children can learn awareness. The e-comics also aid in raising awareness about childhood obesity. Additionally, this project supports the notion that multimedia components are crucial in education. Additionally, this project can improve the educational materials available on the subject of e-comics. Additionally, this project strengthens the researcher's capacity to create useful applications on their own.

ACKNOWLEDGMENT

The authors would like to acknowledge Universiti Teknikal Malaysia Melaka for allowing them to use the campus' resources to conduct this study. Sincere gratitude is also dedicated to all participants from [Sekolah Jenis Kebangsaan \(T\) Thamboosamy Pillai](#).

REFERENCES

- Aggleton, J. (2019). *Defining digital comics: a British Library perspective*. *Journal of Graphic Novels and Comics*, 10(4), 393–409.
- Obesity and overweight. (2021b, June 9). Retrieved October 20, 2022, from <https://www.who.int/news-room/factsheets/detail/obesity-and-overweight>
- Childhood obesity is a complex health issue. (2022b, March 21). Centers for Disease Control and Prevention. Retrieved October 20, 2022, from https://www.cdc.gov/obesity/basics/causes.html?CDC_AA_refVal=https://www.cdc.gov/obesity/childhood/causes.html
- Lai, W. K. (2022, January 31). *Prevalence and Predictors of Overweight and Obesity Among Adolescents in Seremban, Negeri Sembilan, Malaysia*. Retrieved October 20, 2022, from <https://www.cureus.com/articles/84478-prevalence-and-predictors-of-overweight->
- Malaysia. (n.d.). World Obesity Federation Global Obesity Observatory. Retrieved October 20, 2022, from <https://data.worldobesity.org/country/malaysia-130/>
- Ng, K. (2021, April 21). *How fat are we: Facts and figures about obesity in Malaysia*. FirstClasse. Retrieved October 20, 2022, from <https://firstclasse.com.my/obesity-in-malaysia/>

- Menon, S. (2022, January 16). 'Obesity a problem in schools.' *The Star*. Retrieved October 20, 2022, from <https://www.thestar.com.my/news/nation/2022/01/16/obesity-a-problem-in-schools>
- Ramadhani, Z. (2022, September 30). Designing E-comic for English Reading Material for Grade Eight in Tanjungpinang. *Journal of Language, Literature, and English Teaching (JULIET)*, 3(2), 85–93. <https://doi.org/10.31629/juliet.v3i2.4862>
- Suri, D. A., Astuti, I. A. D., Bhakti, Y. B., & Sumarni, R. A. (2021). E-Comics as an Interactive Learning Media on Static Fluid Concepts. *Proceedings of the 2nd Annual Conference on Social Science and Humanities (ANCOSH 2020)*. <https://doi.org/10.2991/assehr.k.210413.083>



UNIVERSITI
MALAYSIA
KELANTAN

Implementation of Interactive Map Visualization in Crime Detection

Muhammad Asyraf Zolkefli

*Information and Security Assurance, Faculty of Science and Technology,
Universiti Sains Islam Malaysia (USIM)*
asyrf.zlkfl@gmail.com

Nurul Fathihin Mohd Noor Shah

*Information and Security Assurance, Faculty of Science and Technology,
Universiti Sains Islam Malaysia (USIM)*
fathinshah@usim.edu.my

ABSTRACT

Visualization technologies have proven essential in this era for assisting people in understanding data while also leveraging the human visual system to analyze large amounts of information. Data visualization is also used to visualize and display data based on data characteristics and attributes, which can aid in understanding and locating information within the data. Crime data is one of the most important pieces of information for any country's law enforcement. Considering the importance of data related to crimes, the analysis of these criminal records is essential to crime detection and prevention. There are a variety of analysis methods and approaches used to visualize large amounts of crime data. Therefore, the focus of this paper is on how to use interactive map visualization to analyze and show crime data connected to a place on a map. This infographic shows different Python libraries and tools that can be used to visualize crime data by putting data into WebGIS map functions. At present, most of the enforcement agencies in Malaysia only show crime data by displaying it as numerical data and non-interactive visualization data such as bar charts and graphs. Python and JavaScript are used in the development phase of this system application. For this project, agile methodology was used, and crime alerts with notifications have been added as for security features. The effectiveness of using interactive map visualization is discussed.

Keyword: *Crime Detection; Interactive Map Visualization; Data Visualization; Crime Data; WebGIS*

INTRODUCTION

Crime is a major social problem that has been a focus in developed countries. Crime can be defined as an activity that is against the laws of a nation because crime has many effects on the daily lives of the citizens. The majority of the costs incurred as a result of criminal activity are direct costs, which can be called immediate impact and indirect costs, in other name, long-term effect. Examples of indirect costs include fear of crime, lower life satisfaction level, psychological issues and decreased quality of life. In effect, major concern throughout criminal and violent behavior has been made in recent years across the globe through electronic media and extensive coverage in newspapers because crime rates vary enormously across countries and regions.

Crime has become one of the serious issues of our society for a time being. Foon Tang. C (2019) made a statement that crime was both the cause and consequence of poverty, insecurity and under-development, in fact that many country's policy makers have poured a major amount of concern towards crime issues. Therefore, technology advancements have been made to reduce crime and enhance police performance. There are various technological advancements such as surveillance cameras, data gathering systems, heat sensors, facial

recognition, GPS tracking, Internet and telecommunications systems which are used to detect, investigate, prosecute, and prevent crime in law enforcement.

According to James Byrne (2019), there are two broad categories of innovations in criminal justice technology. Hard technology innovations include new materials, devices, and equipment that can be used to either commit crime or prevent and control crime, meanwhile soft technologies involve the strategic use of information to prevent crime and to improve the performance of the police. Soft technology innovations involve crime analysis techniques where crime mapping takes part in for law enforcement agencies to map, visualize and analyze crime incident patterns. Furthermore, crime mapping helps law enforcement agencies plan on resource use and predict hotspots likely to experience crime (Sahar Bayoumi, 2018). Hence, crime analysis with crime mapping can be plugged into data visualizations to ensure the data is readable, queryable and actionable.

Data visualization has been used in many fields of disciplines within organizations. In data visualization, data is abstracted and summarized in innovative ways to present large and complex information from organizations. It has emerged as a powerful and widely applicable tool for analyzing and interpreting large and complex data. In this era, there has been a need to display massive amounts of data generated by the organizations in an easily accessible and understandable manner. Large, time-varying datasets pose a great challenge for data visualization because of the enormous data volume (L. Yu et al., 2020).

Visualization technologies have proven essential for helping people understand data by leveraging the human visual system to analyze large amounts of information (Hellerstein, J. M. 2009). In addition, data visualization can be used to see outstanding information in simple and quick ways. In fact, data visualization has become more important and popular in many fields over the past few years (Kirk 2012; Yau 2013). Along with the growing interest in data visualization, a number of new interactive visualization tools have been made, which allow people with different levels of technical knowledge to interact with data and see it in different ways (Kyler E. Walker, 2016). Furthermore, organizations can use interactive data visualization to look into details, find patterns and outliers, and change which data are used or left out (Dan Streetman, 2020).

RESEARCH BACKGROUND

Cities in developing countries such as the United States play a major role in society as a result of continual urbanization and expanding populations. However, such advancements have coincided with a rise in violent crimes and accidents (Othman, F. 2020). Crimes and criminalities are so prevalent in various communities around the world that no community is free of at least one criminal act (Ajagbe et. al, 2020). Therefore, enforcement agencies can overcome these issues by using advanced technologies such as data visualization in order to identify the crime pattern and support decision-making in crime prevention.

Crime prevention is a concept that has been applied in a number of different ways to the problem of crime. There are many studies analyzing technologies within crime prevention and detection. According to Julie Mennell (2019), the process of detecting crime is divided into three stages. The three stages of detecting crime include the discovery of a crime committed, the identification of suspects, and the gathering of evidence. In this technology era, several technology-rich environments are used in crime prevention, such as :

- Automated plate recognition - Police forces across the country used automated plate recognition to determine the location and movements of vehicles, as well as to aid in the identification of criminals and criminal activity.
- CCTV - used to capture footage and images related to potential criminal activity and to aid in the identification of offenders.
- Mobile phones (social media) - have the ability to gather information about a crime, whether knowingly or unknowingly by the owner.

Dave Kelly (2021) proposed that data is a valuable resource for law enforcement, but it is ineffective without data visualization. Data visualization enhances data analytics by turning information gathered from numerous sources into a clear picture through the use of elements such as graphs, charts, and maps. By using data visualization, crime data can be simplified into a simple perspective that may benefit officers, analysts, and public citizens in a variety of ways. Insights from visual analytics also help keep law enforcement employees and citizens safe, lower operating costs, and improve the results of investigations.

As an example, police departments all over North America use data visualization technology all the time to keep track of criminal activity. Figure 2.1 shows one of the non-government websites known as SpotCrime, which currently uses interactive maps in data visualization for crime detection and covers the North America region. According to Pete Snelling (2022), in North America, police are placing more emphasis on systems that provide real-time images of areas that are integrated with crime and traffic. Critical information may go unnoticed if the ability to view the real-time picture is not available, resulting in wrong decisions or no action at all. Addressing the importance of data visualization leads to intelligent policing in enforcement agencies. With data visualization, tactical and strategic reports can be made quickly using legal data from a variety of sources and delivered in a variety of formats (Snelling, P. 2022).

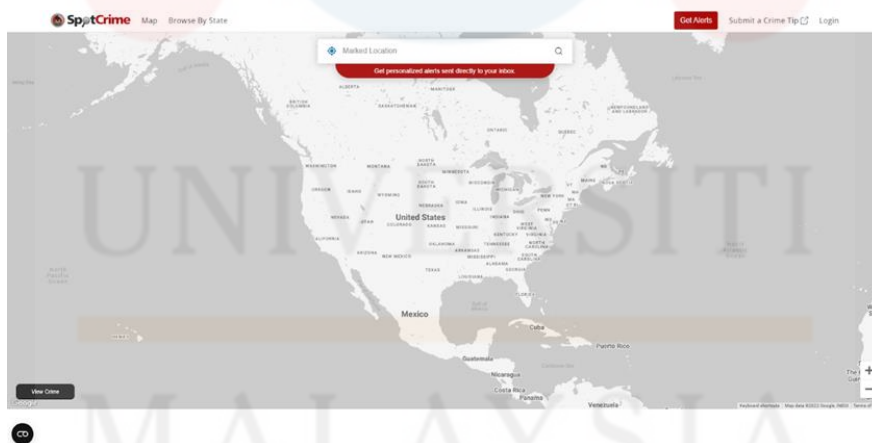

Figure 2.1: SpotCrime

However, in Bangladesh, with a population of 161 million, data visualization in crime analysis is still in its infancy. Furthermore, the limited usage of data visualization technologies in Bangladesh is primarily related to land management and geographical study (Alrefat, M. 2018). Besides that, one key aspect that hinders the analysis of crime distribution via data visualization in Bangladesh is the lack of access to primary crime data (Islam, M. J. 2018). As a result, the application of data visualization to dealing with crime data has been limited.

There are various methods of data visualization that will go through a process that is based on qualitative or quantitative data and produce results that are representative of the collected data (adapted from Molina, B. 2021). Figure 2.2 shows types of data visualization that have been generally used by certain organizations for crime detection, and further detail will be gone through in this topic.

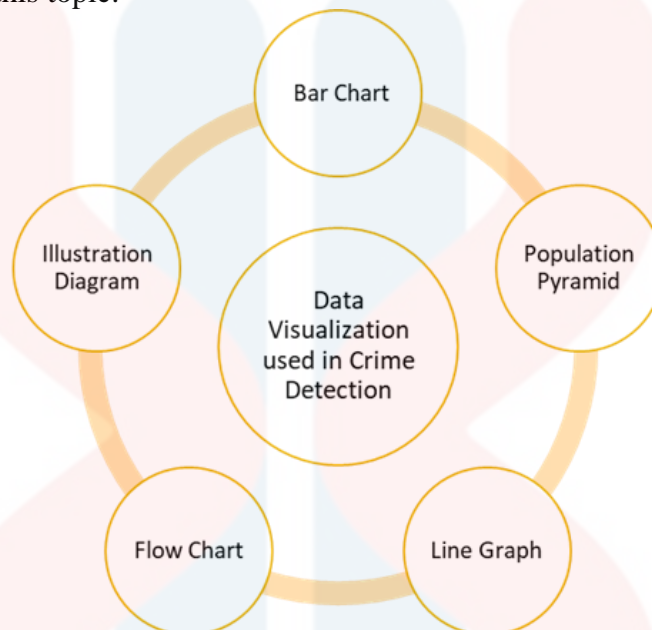

Figure 2 .2: Data Visualization of Crime Detection

Bar Chart

The bar chart uses either horizontal or vertical bars to show clear comparisons of numbers across categories. Since William Playfair made the first bar chart in 1786, statisticians have used them to make discrete quantitative data easier to understand (Beniger & Robyn, 2018). In another study, the author looked at bar charts, which can be used to show visual comparisons between different qualitative categories. Figure 2.3 shows an example of a single bar chart, while Figure 2.4 displays a type of data visualization called a grouped bar chart.

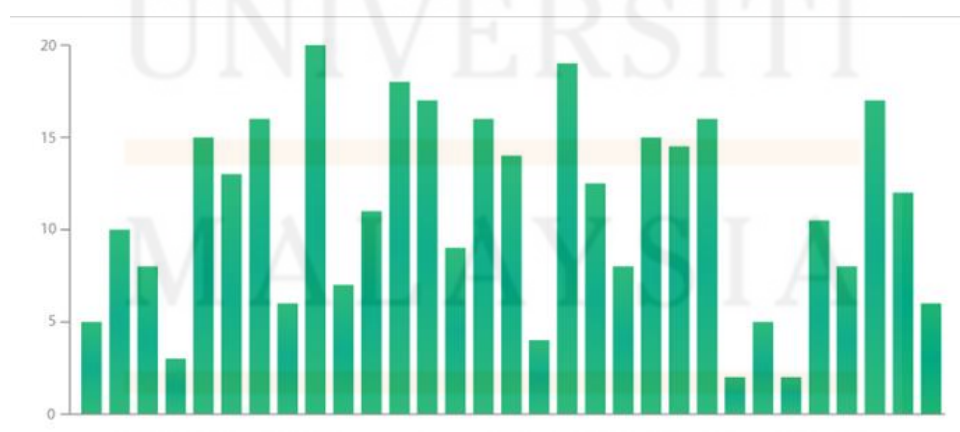

Figure 2. 3: Single Bar Chart

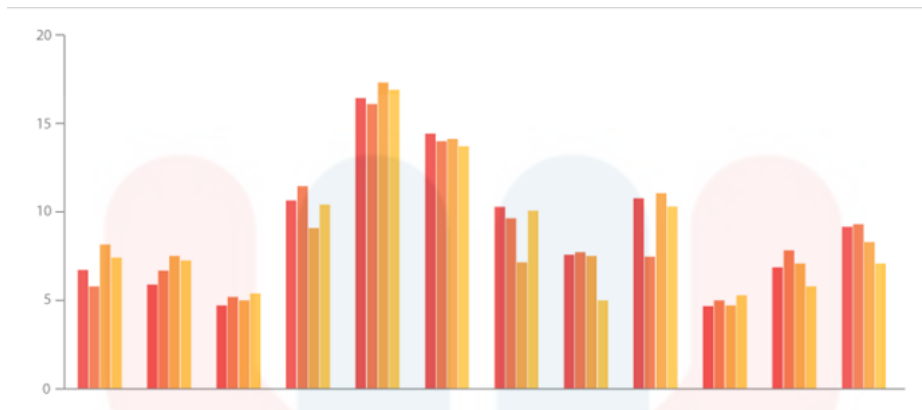

Figure 2.4: Grouped Bar Chart

Population Pyramid

A population pyramid is a pair of back-to-back histograms that show how a population is distributed across all age groups and genders, as shown in Figure 2.5. Population pyramids are particularly useful for detecting changes or discrepancies in population trends. Multiple population pyramids can be used to compare patterns across countries or populations. The shape of a population pyramid can be used to interpret a population. A population with both a high birth rate and a high death rate is shown by a pyramid with a very wide base and a narrow top. On the other hand, a pyramid with a wider top half and a narrower base would show that the population is getting older and that birth rates are low.

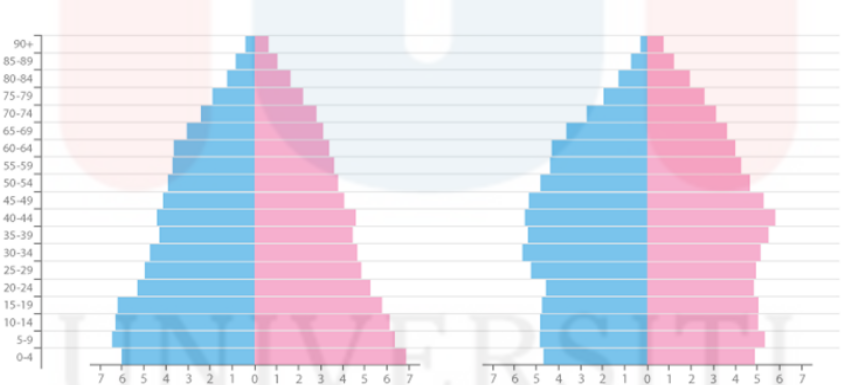

Figure 2.5: Population Pyramid by Gender

Line Graph

Since William Playfair made the first line graph in 1786, they have been used a lot to show how data changes over time. Line graphs are used to show numerical values over a continuous interval or time period. Figure 2.6 defines that a line graph is commonly used to demonstrate patterns and analyze how data has evolved over time. Line graphs are created by first plotting data points on a cartesian coordinate grid and then connecting all of these points with a line. The y-axis is usually a number, while the x-axis shows a range of time or a set of intervals. Negative numbers can be shown beneath the x-axis.

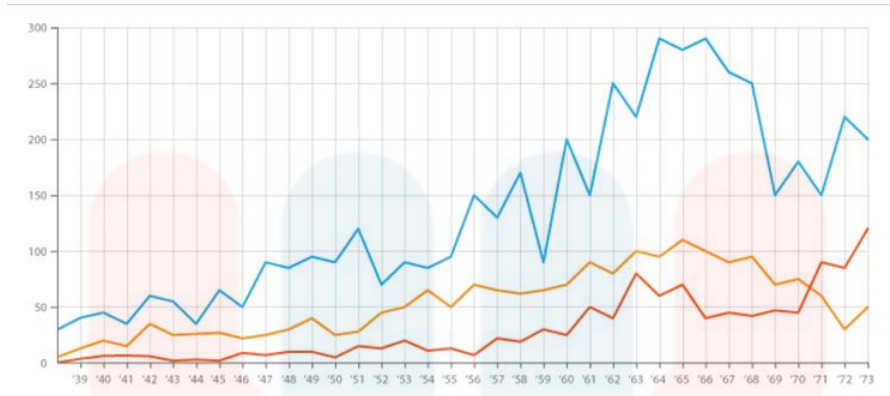

Figure 2.6: Line Graph

Choropleth Map

Choropleth maps are extensively used for data presentation. It was represented by separating geographical areas or regions into colored, shaded, or patterned regions based on a data variable. This makes it possible to see values across a geographic area, which could show differences or patterns across the place shown. In each section of the map, the data variable is shown by a color progression. The accuracy required to read or compare values on a map is diminished by the use of color. A typical mistake when creating choropleth maps is encoding raw data values (such as population) rather than utilizing normalized values (such as people per square kilometer) to create a density map (Andrienko, G., n.d.).

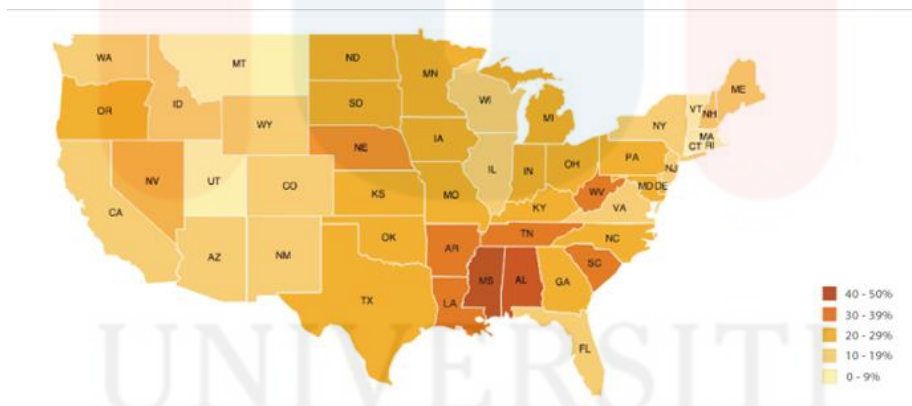

Figure 2.7: Choropleth Map

Illustration Diagram

An illustration diagram is a diagram or graphical depiction. Labels or information are placed on the image to describe how certain sections of the image work. It is a fundamental phenomenon that images make everything easier to learn and remember. The illustration graphic is very simple to grasp because it shows all of the labels alongside the photographs. The methods shown in these diagrams take less time and work well in a number of ways. In Figure 2.8, the percentage of water in the human body was visualized using an illustration diagram. Images used can be in the form of illustrations, preliminary sketches, wireframes, or pictures. As a result, images might be symbolic, pictorial, or realistic.

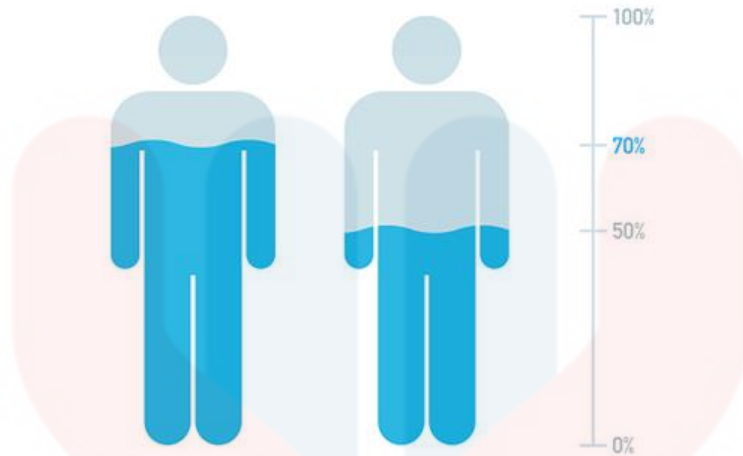

Figure 2.8: Illustration Diagram of Water Percentage in Human Body

Data visualization can be used to see outstanding information in simple and quick ways. Emerging technology innovation creates a data-driven environment that allows for swift decision-making. However, it is becoming increasingly important for professionals, particularly security personnel and government officials, to be able to use suitable data visualization tools to make judgments and use visuals to tell stories about how, who, when, where, and what the data is saying.

Further research is conducted by observing the existing website with crime detection statistics in Malaysia. There are five existing websites selected in this research.

Department of Statistics Malaysia

The Department of Statistics Malaysia is a top government agency that is in charge of collecting, interpreting, and sharing the most recent and up-to-date statistics to keep track of the country's economic and social development. On this website, the current range of years for crime rates and statistics is from 2015 to 2021. Figure 2.9 shows the crime index ratio within every state in Malaysia per 100 000 citizens.

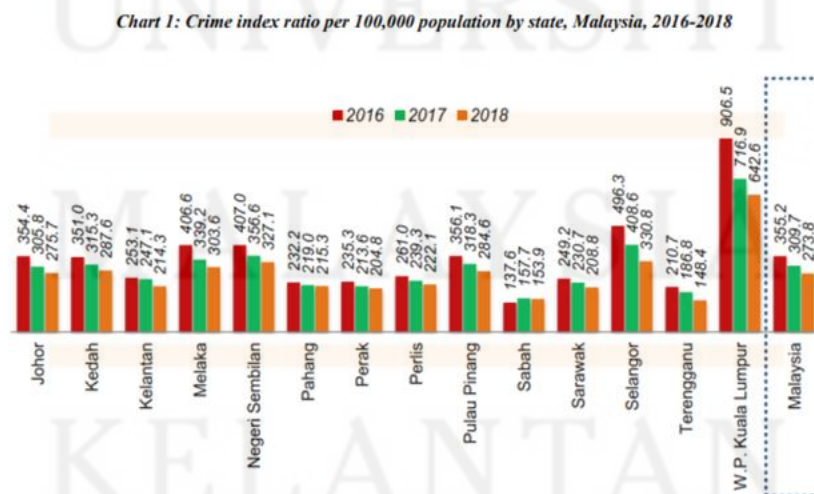

Figure 2.9: Crime Index Ratio per 100,000 population by state in Malaysia

Macrotends

Macrotends is a global website that provides various charts with many types of data, such as stock research, market indices, and commodities. Macrotends' website also provides certain data from Malaysia with statistics, such as the unemployment rate, urban population, and crime rate. In Figure 2.11, Macrotends convert the crime data from Figure 2.10 into line graphs versus bar graph data statistics.

Malaysia Crime Rate & Statistics - Historical Data		
Year	Per 100K Population	Annual % Change
2013	2.13	2.74%
2012	2.07	11.95%
2011	1.85	-3.36%
2010	1.91	-5.36%
2009	2.02	-7.72%
2008	2.19	-10.17%
2007	2.44	8.73%
2006	2.24	-4.55%
2005	2.35	19.16%
2004	1.97	-13.75%
2003	2.29	-1.98%

Figure 2.10: Malaysia Crime Rate & Statistics from 2003 to 2013



Figure 2.11: Line graph of per 100 000 population versus bar graph of Annual % Change

Numbeo

A personal website developed by Mladen Adamovic, a software engineer, in 2009. On this website, data within any crime activities was submitted by the user itself through a web-based system. Based on submissions made by the user or contributors, Numbeo can generate a list of percentages along with the risk level that is shown in Figure 2.12. Other than that, Figure 2.13 shows crime and safety indices from some cities in Malaysia.

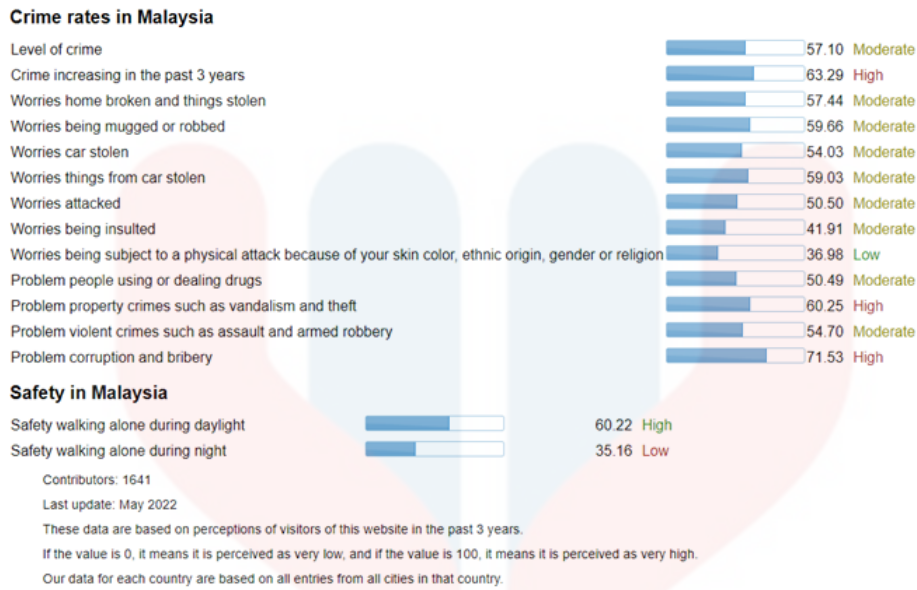

Figure 2.12: Numbeo (1)

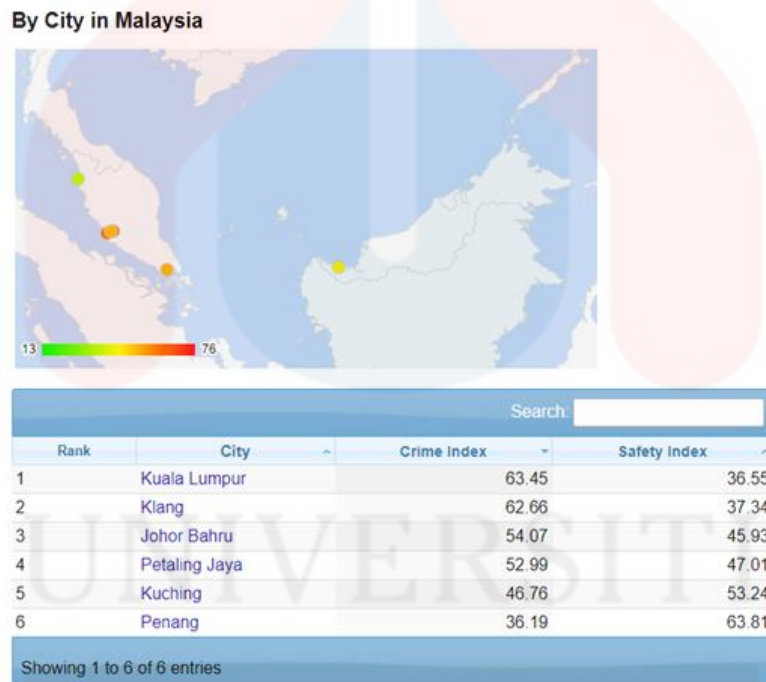

Figure 2.13: Numbeo (2)

Ocindex

A multifaceted tool that analyzes the amount of criminality and resilience to organized crime in 193 nations, including Malaysia. The result of analyzing crime data in Malaysia is shown along with the resilience score in Figure 2.14.

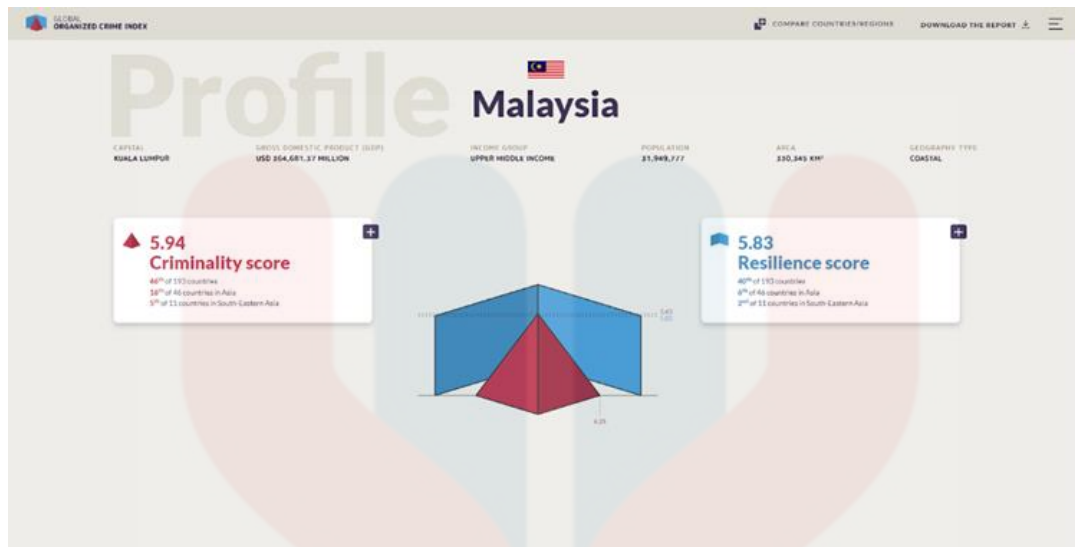

Figure 2.14: Ocindex

DISCUSSION

For crime-related data, it is necessary to use data visualization tools that address all of the data's characteristics and produce results that quickly reveal patterns. Visual information is used to find useful patterns in the world of information and communication technology (ICT) and data science, where every piece of information is important. This is something that traditional methods of data visualization cannot do in the world of dynamic crime (Ajagbe et al., 2020). In crime prevention, different visualization techniques can be used to explore the data and make it easy to see the important information.

Geospatial technology in interactive data visualization needs to be utilized for capturing crime data based on spatial location for monitoring, evaluation, and spatial analysis of crime-related data. Interactive data visualizations can make it easier to access and explore large, complex datasets, which can lead to better understanding and knowledge discovery. (Walker et al. 2020). Moreover, interactive data visualizations can be effective tools to help us better understand datasets and the phenomena they represent through a process known as visual analytics (Heer et. al, 2012)

CONCLUSION

Crime has always been part of our everyday lives, resulting in misery and even the loss of life. In Malaysia, and probably in other countries as well, it is clear that crimes involve the use of force to take people's property and lives, which is against their property rights. Hence, providing a criminal justice system is a part of crime prevention that the government took on for the sake of protecting citizens and the nation's property. The rising crime information in types of places where the crime mostly occurred and how high the density of it is has not yet been shown in detail in any Malaysian platform or website, neither by the government nor any non-government organization. Therefore, improving spatial analysis and data visualization using WebGIS will enable a practical and adaptable method for interactive map applications and have a significant positive impact on crime detection.

REFERENCES

- Chou, L. (2021, December 11). Top 10 Map Types in Data Visualization - Towards Data Science. Medium. <https://towardsdatascience.com/top-10-map-types-in-datavisualizationb3a80898ea70#:~:text=Map%20visualization%20is%20used%20to,of%20data%20in%20each%20region>.
- Akinsola, J. E. T., Ogunbanwo, A. S., Okesola, O. J., Odun-Ayo, I. J., Ayegbusi, F. D., & Adebisi, A. A. (2020). Comparative Analysis of Software Development Life Cycle Models (SDLC) (pp. 310–322). https://doi.org/10.1007/978-3-030-51965-0_27
- Al-Saqqa, S., Sawalha, S., & AbdelNabi, H. (2020). Agile Software Development: Methodologies and Trends. *International Journal of Interactive Mobile Technologies*, 14(11).
- Andrienko, G., Andrienko, N., & Savinov, A. (n.d.). CHOROPLETH MAPS: CLASSIFICATION REVISITED.
- Beniger & Robyn. (2018). Bar Chart. In *Encyclopedic Dictionary of Archaeology* (pp. 134–134). Springer International Publishing. https://doi.org/10.1007/978-3-030-58292-0_20122
- Crime Analysis in Malaysia. (2019). Ocindex. <https://ocindex.net/country/malaysia>
- Crime in Malaysia. (n.d.). Numbeo. https://www.numbeo.com/crime/country_result.jsp?country=Malaysia
- Department of Statistics Malaysia Official Portal. (n.d.). Department of Statistics Malaysia. <https://www.dosm.gov.my/v1/index.php> 32
- Foon Tang, C. (2019). The Linkages among Inflation, Unemployment and Crime Rates in Malaysia. In *Journal of Economics and Management* (Vol. 3, Issue 1). <https://www2.unodc.org/unodc/en/data-and-analysis/United-Nations-Surveyson-Crime-Trends>
- Habibullah, M.S., Baharom, A.H., Muhamad, S. (2018) Crime and police personnel in Malaysia: an empirical investigation. *Taylor's Bus. Rev. (TBR)* 4(2), 1–17
- Snelling, P. (2022). Intelligent policing: Data visualization helps crack down on crime. (n.d.). SAS. https://www.sas.com/en_us/insights/articles/risk-fraud/datavisualization-crime.html
- Ishak, S., & Bani, Y. (2017). Determinants of Crime in Malaysia, Evidence from Developed States. *Int. Journal of Economics and Management*, 11(S3), 607–622.
- Islam, M. (2018) Khatun and Islam Crime in Bangladesh *Social Science Review*, Volume-35, No-2 (December), 2018 CRIME IN BANGLADESH
- Jena, M. (2022, June 8). Data Validation: Understanding its Working & Importance Simplified 101. Learn | Hevo. <https://hevodata.com/learn/data-validation/#imp>
- Kelly, D. (2022, March 18). How Law Enforcement Can Use Data Visualization to Improve Efficiency and Effectiveness. The TIBCO Blog. <https://www.tibco.com/blog/2021/11/11/how-law-enforcement-can-use-datavisualization-to-improve-efficiency-and-effectiveness/>
- Lau, P. H., & Ali, K. (2019). Citizen participation in crime prevention: a study in Kuching, Sarawak, Malaysia. *Journal of Criminological Research, Policy and Practice*, 5(2), 144–160. doi:10.1108/jcrpp-01-2019-0005
- Malaysia Crime Rate & Statistics 1990–2022. (n.d.). MacroTrends. <https://www.macrotrends.net/countries/MYS/malaysia/crime-rate-statistics> 33
- Map.(n.d.).SpotCrime.<https://spotcrime.com/map?lat=2.8345414453989513&lon=101.78908189267015&address=>
- Meng, X., Ma, L., & Zhou, Y. (2022). Analysis and Example Implementation of Data Visualization Technology. 56–60.

- Molina, B. (2021, December 10). Geospatial data visualization in Jupyter Notebooks - Barto Molina. Medium. <https://medium.com/@bartomolina/geospatial-datavisualization-in-jupyter-notebooks-ffa79e4ba7f8>
- Murray, S., 2017. Interactive data visualization for the web: an introduction to designing with. Sebastopol: O'Reilly Media, Inc.
- Musa, S. M., Akujuobi, C., Sadiku, M. N. O., Shadare, A. E., Akujuobi, C. M., & Perry, R. G. (2016). Publication Impact Factor (PIF): 1.02 www.sretechjournal.org DATA VISUALIZATION. International Journal of Engineering Research And Advanced Technology.
- Othman, F., Mohd Yusoff, Z., & Salleh, S. A. (2020). THE IMPACT OF PHYSICAL FEATURES AND ENVIRONMENT ON CRIME IN URBAN NEIGHBOURHOOD AREAS. In Journal of the Malaysian Institute of Planners (Vol. 18).
- Quach, Q., & Jenny, B. (2020). Immersive visualization with bar graphics. Cartography and Geographic Information Science, 47(6), 471–480. <https://doi.org/10.1080/15230406.2020.1771771>
- Reips, U.-D. (2009). Internet experiments: Methods, guidelines, metadata. Human Vision and Electronic Imaging XIV, Proceedings of SPIE, 7240, 724008.
- Stasko, John., Ward, Matt., & IEEE Computer Society. Technical Committee on Visualization and Graphics. (2005). InfoVis 05 : proceedings, IEEE Symposium on Information Visualization (InfoVis 052005), Minneapolis, Minnesota, October 23-25, 2005. IEEE. 34
- Taherdoost, H. (2018). Validity and Reliability of the Research Instrument; How to Test the Validation of a Questionnaire/Survey in a Research. SSRN Electronic Journal. <https://doi.org/10.2139/ssrn.3205040>
- Truijens, F., De Smet, M. M., Desmet, M., & Meganck, R. (2021). Validity of Data as Precondition for Evidence: A Methodological Analysis of What is Taken to Count as Evidence in Psychotherapy Research. Philosophy, Psychiatry, & Psychology, 28(2), 115–128. doi:10.1353/ppp.2021.0018
- Walker, K. E. (2016). Tools for Interactive Visualization of Global Demographic Concepts in R. Spatial Demography, 4(3), 207–220. <https://doi.org/10.1007/s40980-016-0029-1>
- Wilkins EL, Radley D, Morris MA, Griffiths C. (2017). Examining the validity and utility of two secondary sources of food environment data against street audits in England. Nutr J. 2017;16(1)
- Zakaria, S., Rahman, N.A. (2016) The mapping of spatial patterns of property crime in Malaysia: normal mixture model approach. J. Bus. Soc. Dev. 4(1), 1–11
- Alrefat, M., Nurjahan Khatun, M., & Islam, M. J. (2018). Khatun and Islam Crime in Bangladesh Social Science Review, Volume-35, No-2 (December), 2018 CRIME IN BANGLADESH: A HISTORICAL OVERVIEW (Vol. 1)
- W. Yin et al., "An Interactive Data Visualization Design Based On WebGIS," 2019 IEEE 3rd Information Technology, Networking, Electronic and Automation Control Conference (ITNEC), 2019, pp. 2462-2465, doi: 10.1109/ITNEC.2019.8729221.

Implementation Speech Recognition in Expiry Alert System

Muhammad Alif Amiry bin Abdul Wahab
Information and Security Assurance, Faculty of Science and Technology,
Universiti Sains Islam Malaysia (USIM),
amiryalif@gmail.com

Nurul Fathihin Mohd Noor Shah
Information and Security Assurance, Faculty of Science and Technology,
Universiti Sains Islam Malaysia (USIM),
fathinshah@usim.edu.my

ABSTRACT

In this era, speech recognition has widely been used daily in many applications such as smart home applications and for educational purposes for people who are deaf and hard of hearing. Speech recognition is the process of recognizing and translating spoken language into text. At present, there are applications to alert people about the expiry date of the products, but many people do not know the emergence of these applications. Expiry alert application capable of reminding people, especially households, shop owners, and suppliers, about the expiry date. The current system's limitation was not fulfilling all requirements features for all kinds of people. Current features that have been implemented in some applications are barcode scanner features, search bar features, classified features, and notification features. Therefore, this project is to make an enhancement to the expiry alert application by add on speech recognition to the system application. The aim of this project is to develop an expiry alert system that can be used by all users, especially those who are special needs. This project focuses on speech recognition tool design and a deep analysis would be required to identify the best speech recognition design to make this application can assist and help special need user. Java, XML, Web Speech API, and Gradle are used for this system in the development phase. Lastly, Agile Methodology was selected to develop this project and for the security features, two-factor authentication is selected for the system.

Keywords: *Speech recognition, Special need user, mobile application, expiry date application.*

INTRODUCTION

Nowadays, technology has become a part of all people's lives around the world. Technology is increasing rapidly in meeting every universal human need and has certainly changed the way we live. The rise of computers and mobile phones has led to an increase in the number of people who rely on technology to keep up with the latest technology. Technology has also helped in people's daily lives. Technology has allowed people to connect with their friends and family more easily, improve their social communication, and treat themselves in various media and entertainment outlets.

Many applications on Android or iOS have existed with the help of technology. Expiry alert system applications are one of the technologies that are very useful for people nowadays to get notifications of the expiry dates of their products. This application helps many people, or consumers, manage their products with the expiration date. Consumers may not remember the expiration date of each product. It is also difficult for consumers to manually note each product's expiration date for the purpose of reminders (Bentahar et al., 2021). When people use expired products, especially foods and drinks, their health can get worse and bad things can

happen to them. Therefore, the emergence of this type of technology helps people track the expiration dates of products. It also reminds the users when the expiration date of the products is about to end, so they can take care of their health by not taking expired products.

There are many applications on Android or iOS that have existed to help people get notifications of the expiration dates of their products. Expiry date tracker and best before are some examples of expiry alert applications that are available in Android, while expiry alert and expiry journal are some examples in iOS. There are some features that can be found in expiry alert applications, such as barcode scanner features, notification features, and search bar features. Barcode scanner features use a scanner from the camera to scan the barcode that is on the products, and then it will automatically key the products into the inventory. Next, the notification feature is a common feature for an expiry alert application that gives people notifications about the products when they are about to expire. Lastly, the search bar features are for searching the products in the inventory and can help people who have many products.

Currently, there are no features for people with special needs, especially visually impaired people and people with physical disabilities who cannot move their hands or bodies. These categories of people will face difficulties managing their groceries. They also will face the same problem as other people in managing food products with an expiration date.

So, we have proposed speech recognition as an enhancement to the expiry alert application. The speech recognition features help special people who find it hard to use a mobile application like normal people. Speech recognition converts spoken language into text for the special people to use easily in their daily lives like other people.

RESEARCH BACKGROUND

Speech Recognition

Speech recognition is the process of converting an audio waveform into text or a string of words that should be the same as what was said. In the field of computer systems, speech recognition is defined as the ability of computer systems to understand spoken words in audio format, as well as the steps needed to make computers do speech recognition, such as voice recording, word boundary detection, feature extraction, and recognition using knowledge models.

Speech Recognition System

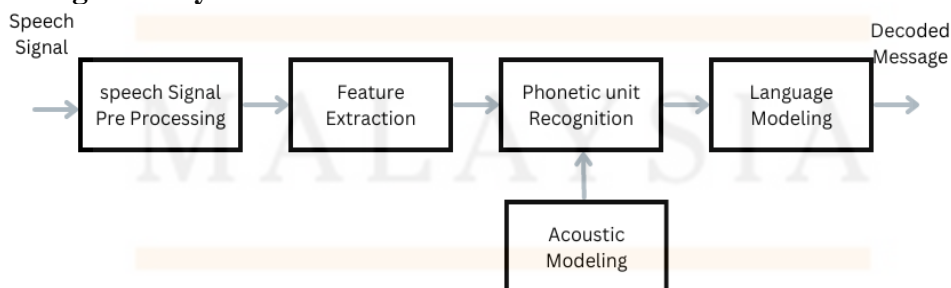

Figure 1: Module of the speech recognition system

Speech Signal Acquisition: At this stage, an analog speech signal is captured in.wav format using a high-quality, noiseless, unidirectional microphone and transformed into a digital speech signal.

Feature Extraction: Feature extraction is an important part of making an SR system. In this step, a fragmented series of feature vectors is computed to give a compact representation of the input signal. The initial stage of the feature extraction procedure is the speech analysis of the spoken signal, in which raw characteristics representing the envelope of the power spectrum are created.

Acoustic modeling is the development of models that relate the observed properties of speech signals with the predicted pronunciation of the hypothesis word or sentence.

Language and lexical modeling: word confusion must be looked at with caution, and an acoustic model alone cannot manage it. The lexical model provides word pronunciation in the selected language and comprises the mapping between words and phonemes. The main goal of adaptation is to make the system less dependent on the speaker's voice, microphones, the transmission channel, and the acoustic environment. This makes the system better at generalizing.

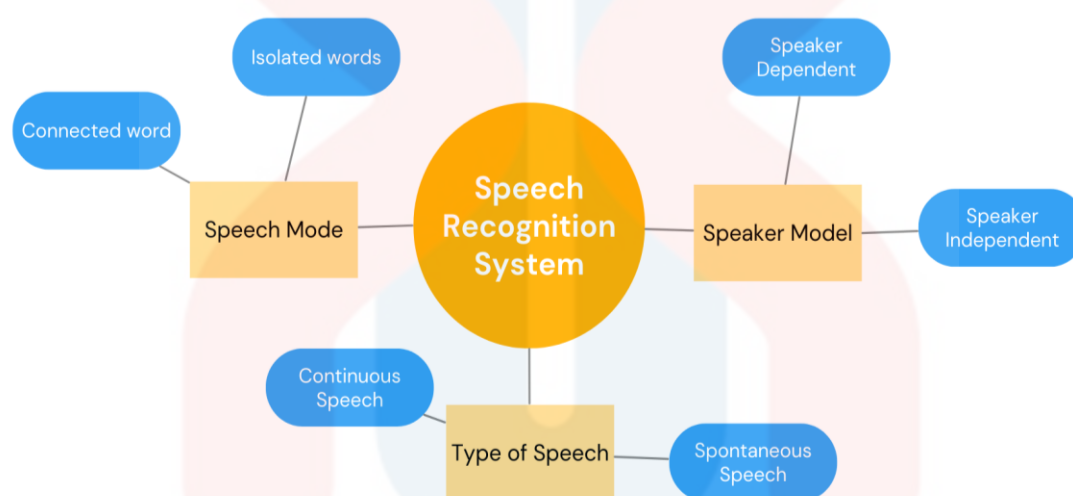

Figure 2: Speech Recognition System

Speech recognition technology refers to a computer's capability to listen to input words and provide the right meanings of those words. In other words, it converts input audio files to text. The term is called automatic speech recognition (ASR). The method could be used in computers so that they could recognize words spoken by people through a microphone or a phone. In speech recognition, there are two types of speech modes that need to be focused on: isolated words and connected words, to make sure the utterance is recognized correctly. Firstly, isolated words mean a speaker must provide a short gap between words when using the isolated word voice recognition system. It does not imply that it recognizes single words, but rather that it involves just one speech at a time. This works well when the user needs to give one-word answers or orders, but it is very rare that they need to provide more than one word. Secondly, connected words are equivalent to isolated words, but they allow independent utterances to be run together with a minimal gap in between.

Other than that, there are two types of speech: continuous speech and spontaneous speech. In continuous speech, recognizers allow people to talk normally while the computer completes the content. It has a huge amount of "co-articulation," which is when words next to each other are spoken at the same time without any visible pauses or gaps. Co-articulation is when two or more sounds are made at the same time in a way that affects the other sounds. Continuous voice recognition systems are very hard to make because they have to use unusual ways to figure out where one utterance ends and the next one begins. Confusion between distinct word sequences grows as the vocabulary list grows.

Spontaneous speech is the sort of speech that is spontaneous and unrehearsed. Speech generated spontaneously or extemporaneously has disfluencies and is significantly more difficult to distinguish than speech read from a script. It's very hard to understand because it's full of mistakes like "uh" and "um," false starts, incomplete sentences, coughing, and laughter, and the vocabulary is pretty much endless, so the system should be able to figure out how to deal with words it doesn't know.

Furthermore, in speech recognition, there are also two types of speaker models: speaker-dependent models and speaker-independent models. Speaker-dependent models work like voice recognition in that they learn the unique characteristics of a single person's speech. Speaker-dependent systems are built around a single speaker. A speaker-dependent system is meant to employ a single speaker and requires a user to supply samples of his or her voice before utilizing it. To begin, new users must train the program by speaking to it so that the computer can evaluate how the individual speaks. People often have to read a few pages of text to their computers before they can use speech recognition.

Speaker-independent is meant to detect any voice, so the speaker requires no training. This implies that it is the only viable choice for interactive voice response system applications. However, speaker-independent software is often less accurate than speaker-dependent software. Speaker-independent systems are being developed for a variety of speakers with varying articulations. It recognizes the speech patterns of a large group of individuals. This system is the most difficult to create, has the longest training time, and gives less accuracy than speaker-dependent systems. They are, nonetheless, more flexible.

There are many types of speech APIs, such as the Google API, CMU Sphinx, and Microsoft API. These speech APIs have been developed nowadays to help many people convert their spoken language into text.

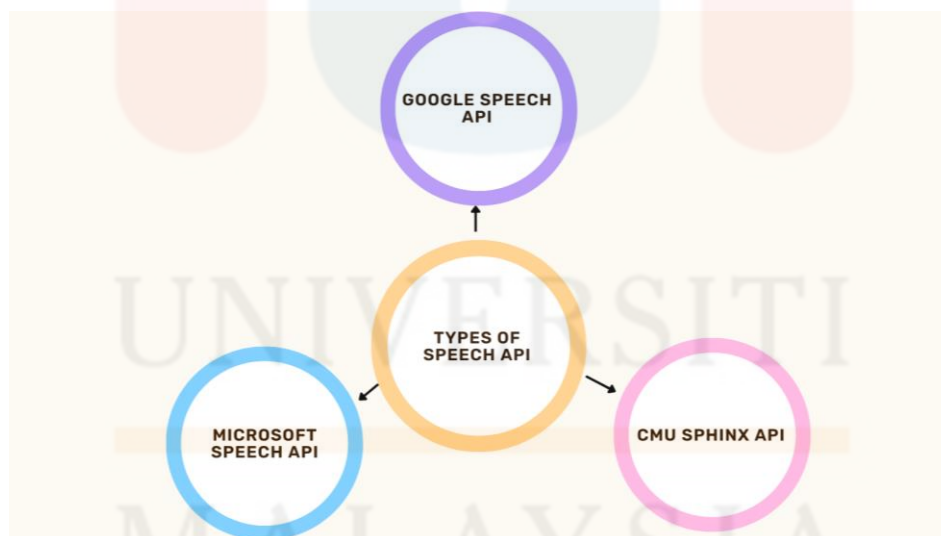

Figure 3: Types of Speech API

Google Speech API

With the Google Speech API, developers can use strong neural network models in a simple API to turn audio into text. To serve the worldwide user base, the API detects over 80 languages and variations. Google has improved its speech recognition by implementing new technology into a variety of Google App applications, including voice search on mobile, voice actions, voice input (spoken input to a keypad), Android Developer APIs, voice search on desktop, YouTube transcription, and navigation. Google reached an 8 percent mistake rate, or word error rate (WER), in 2015 after implementing a new technology known as deep learning neural

networks, a decrease of more than 23 percent from 2013 (Kępuska, 2017). The Google API is the component that offers Automatic Speech Recognition (ASR) support for around 120 languages and dialects (IANCU, 2019). The Google Speech API can also deal with noisy audio in a variety of environments (Choi, J. et al. 2018).

Microsoft Speech API

Microsoft created a voice-chat program or API in 1993 with the Speech API (SAPI1.0) in 1994, which subsequently evolved into the present Speech API (SAPI5.4). The Windows operating system provides speech recognition. Voice synthesis in the Windows Speech API program is often used in application interfaces that let apps talk to each other. Each application can interface with the engine directly. This application interface, including the mechanism, may be changed and built into a toolbox that users can use to develop voice recognition apps. Microsoft enhanced voice recognition by incorporating a deep neural network hidden Markov model (CD-DNN-HMM). This supports long-speech recognition.

CMU Sphinx

Carnegie Mellon University created the Sphinx system (CMU). CMU Sphinx now has a huge vocabulary and a speaker-independent speech recognition framework, and its code is freely accessible for download and usage. Sphinx has different versions and packages, such as Sphinx-2, Sphinx-3, and Sphinx-4, for different tasks and uses. There are also more packages available, such as Pocketsphinx and Sphinxtrain. CMU Sphinx is a set of development frameworks and tools for speech recognition that can be used to connect speech-enabled apps. They have a variety of packages for various jobs and applications. Furthermore, its structure has been intended to be very flexible and adaptable.

- **Pocketsphinx:** a lightweight C library for written recognition.
- **Sphinxbase:** Pocketsphinx required library support.
- **Sphinx-4:** a Java-based decoder for speech recognition search.
- **Sphinxtrain:** Tool for driving acoustic models.
- **Sphinx-3:** a C decoder for speech recognition search.

There are three main components in the Sphinx-4 structure, which include the frontend, the decoder, and the linguist

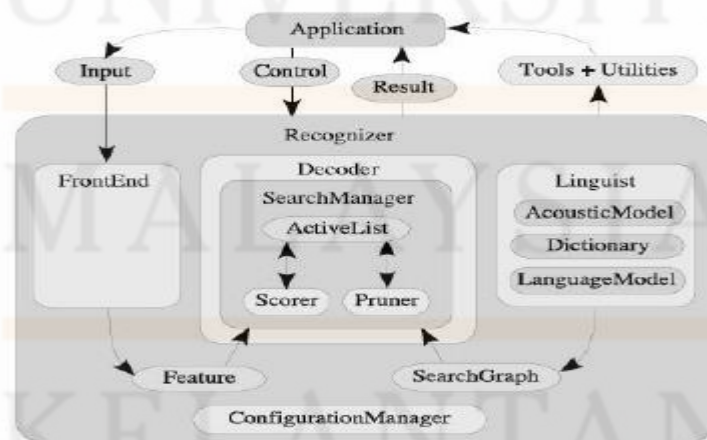

Figure 4: The main component in Sphinx-4

The front end parameterizes one or more input signals into a series of features. The linguist converts any sort of standard language model into a search graph, together with pronunciation information from the dictionary and structure information from one or more sets of acoustic models. The SearchManager in the Decoder performs the decoding by using the features from the front end and the search graph from the linguist. The application can provide controls to each of the modules at any moment before or during the recognition process, thereby becoming a partner in the recognition process.

METHODOLOGY

Overview

In this section, it will be covered how strategy works to make the best framework for building a system. So, the purpose of this is to show the proposed system's strategic approach and explain why it was chosen. There are also a few stages in a chosen technique that one must follow. The clarification of each stage is contained in this methodology.

Agile Methodology

The Agile methodology was chosen to develop the Expiry Alert System Application, which is distinguished by short work cycles that lead to rapid production and continuous revision. According to the research (Rasnacis & Berzisa, 2017), implementing agile methodology leads to improvements in the development process such as fewer bugs, faster delivery, more communication skills, improved quality, improved risk analysis, and reduced costs.

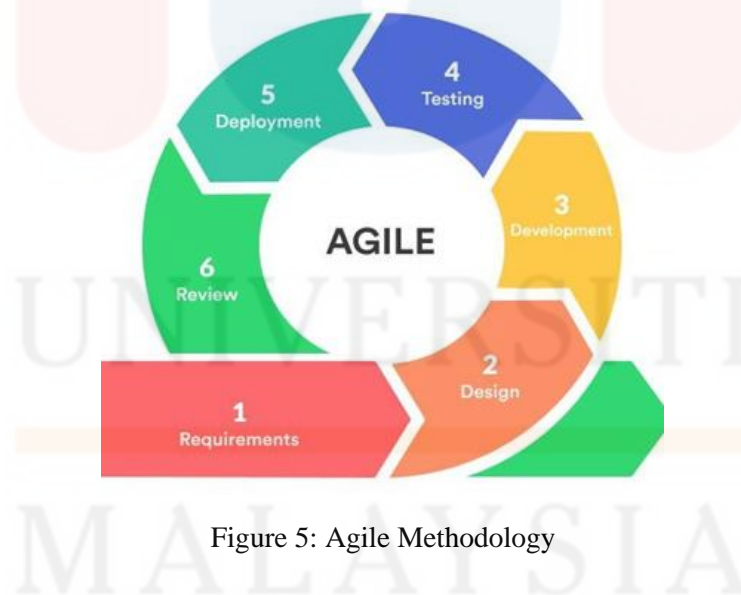

Figure 5: Agile Methodology

Requirement Collection

Requirement collection resulting from some data gathering There are some data gathering methods that can be used to get the requirement collection. The data gathering can be from a literature review, interviews, questionnaires or surveys, user observation, brainstorming, use cases, and scenarios. It is advantageous to have a flexible, user-friendly system for collecting, organizing and making requirements available to the relevant system for application by gathering and developing them.

Design

This step is about the structure of the system and includes diagrams of the architecture of the proposed system. Use-case diagrams are an example of a diagram. Chapter 4 depicts the system's prototype interface design.

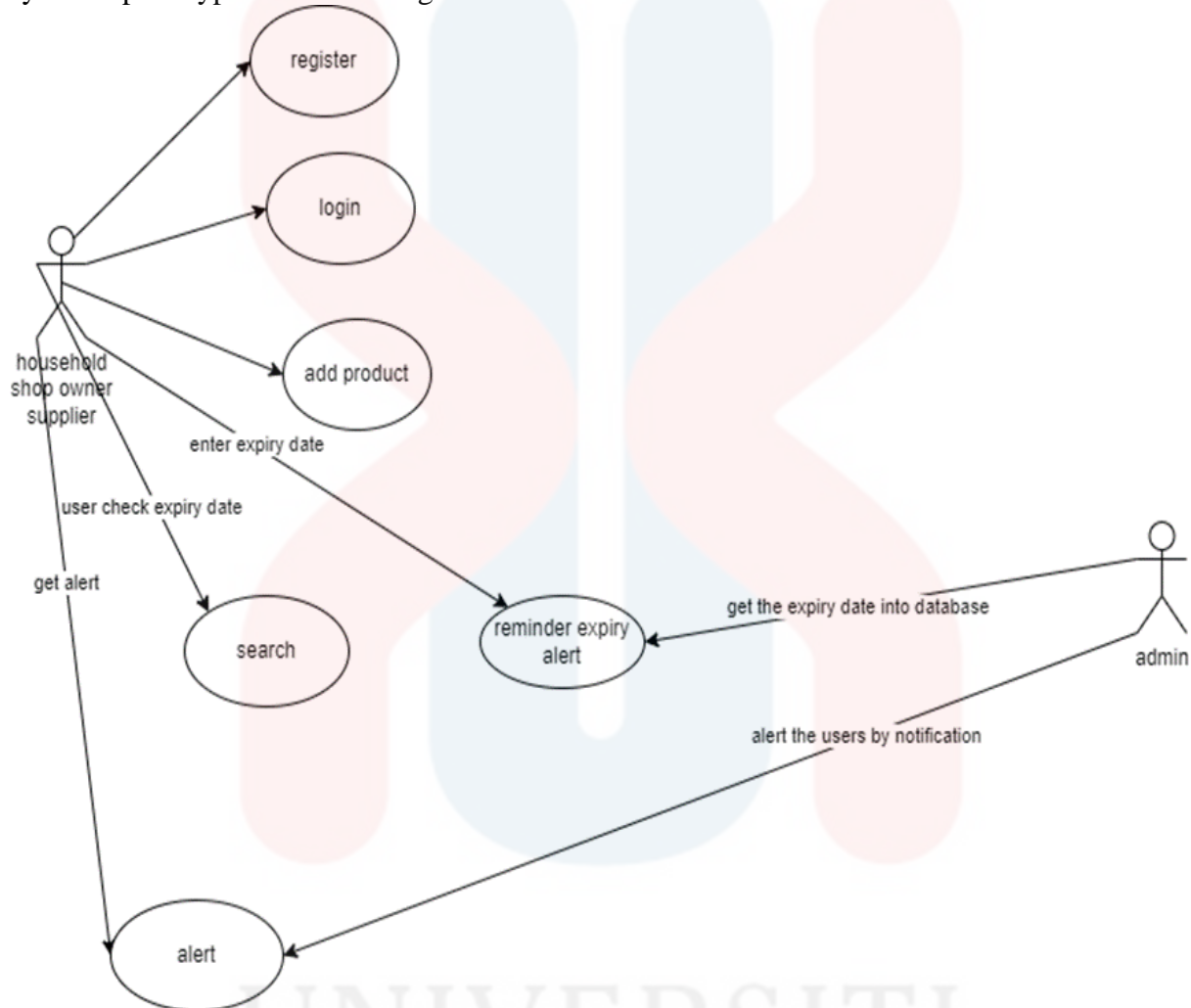

Figure 6: Use Case Diagram

Development

In this phase, all tools that were used in this project's development will be included. Table 1 shows the tools.

Language/ tools	Description
Android Studio	Android Studio is an all-in-one place where you can build, test, and find bugs in apps for Android phones, tablets, Android Wear, Android TV, and Android Auto.
Java	Java is a programming language that is used in the development of Android apps that are to be simple, object-oriented, robust, secure, and high-level.

Java Development Kit	A package of tools and debugger for developing Java
XML	Extensible Markup Language (XML) is used to describe data. It also can be in UI design layouts as front-end development.
Gradle	Gradle is a build automation platform recognized for its versatility in software development. A build automation tool is used to automate application development.
Speech API	A tool for text-to-speech and speech-to-text conversion.

Table 1: System Development

Testing

Agile testing is a continuous procedure that is divided into several stages. With each new release, new features and functions are added. This makes managing the system easier and makes customers happier. During this process, the bugs and device vulnerabilities are observed, fixed, and modified.

Deployment

How developers design, test, and deploy new code will affect both how quickly a product can respond to changes in customer preferences or needs and how well each change works.

Review

The review phase is the final step in the process of creating a product. This phase will evaluate the system's progress toward meeting the requirement. The issues that arise during the deployment phase will be addressed and fixed. The cycle then starts anew.

DISCUSSION

From the research (Kepuska, V., 2017), they have made a paper for comparison between these three speech systems and made a conclusion on the word error rate (WER). It may be concluded that the program that they created to evaluate the CMU Sphinx, Microsoft API, and Google API by using certain audio recordings from various locations with the original words revealed that the CMU Sphinx achieved 37% WER, the Microsoft API achieved 18% WER, and the Google API obtained 9% WER. As a result, it is possible to state that Google's acoustic modeling and language modeling are the best ones.

The size of the vocabulary is also said to have a big effect on the outcome. The ability to change the vocabulary can improve accuracy, which lowers the overall WER even more as the chance of matching patterns correctly goes up (Magnus Stenman, 2015).

CONCLUSION

In conclusion, speech recognition is a useful technology support for people with and without disabilities that is readily available on our mobile devices and laptops nowadays. People with

disabilities who have trouble using any app can get around these problems by using speech recognition. There are many types of speech APIs that can be found in many applications that have been widely used, like in education. Currently, people with special needs very much need our help in using technology to use it, and speech recognition is the one that helps many people with special needs.

From the type of speech API, it can be concluded that Google Speech API can be the best speech recognition system that can be used in many applications based on the word error rate (WER).

REFERENCES

- Bentahar, J., Awan, I., Younas, M., & Grønli, T.-M. (Eds.). (2021). *Mobile Web and Intelligent Information Systems. Lecture Notes in Computer Science.*
- Këpuska, V. (2017). Comparing Speech Recognition Systems (Microsoft API, Google API, And CMU Sphinx). *International Journal of Engineering Research and Applications*, 07(03), 20–24.
- IANCU, B. (2019). Evaluating Google Speech-to-Text API's Performance for Romanian e-Learning Resources. *Informatica Economica*, 23(1/2019), 17–25.
- Choi, J., Gill, H., Ou, S., Song, Y., & Lee, J. (2018). Design of Voice to Text Conversion and Management Program Based on Google Cloud Speech API. 2018 International Conference on Computational Science and Computational Intelligence (CSCI).
- Rasnacis, A., & Berzisa, S. (2017). Method for Adaptation and Implementation of Agile Project Management Methodology. *Procedia Computer Science*, 104, 43–50.

IT Adoption Model for Smart School: A Systematic Literature Review

Endang Sulistiyani

Universitas Nahdlatul Ulama Surabaya
sulistiyani.endang@unusa.ac.id

Nur Shabrina Meutia

Universitas Nahdlatul Ulama Surabaya
shabrinameutia@unusa.ac.id

Rita Sari

Universitas Nahdlatul Ulama Surabaya
ritasari@unusa.ac.id

ABSTRACT

Digital transformation is a necessity in the digital era. Smart school is one of the concepts of using technology in education. Although it has many benefits, the adoption process is still not optimal. Therefore, as a preliminary study, a literature review was carried out. Based on 29 papers, 10 models of smart school adoption were identified. The variables found were 10. TAM is the most widely used technology adoption model in smart schools. The selection of TAM as a technology adoption model is based on the popularity of the model. However, in its implementation, TAM is combined with other models. This is because the results of previous studies show that TAM is not sufficient to describe the actual use of technology. Meanwhile, from the 51 variables found, there are 10 variables that suitable the context of smart schools such as training and education, educational values, curriculum, knowledge sharing, knowledge creation and discovery, knowledge storage, knowledge applications, self-management of learning, teacher efficacy and resistance to class.

Keywords: *adoption; model; smart school; IT*

INTRODUCTION

Smart school is a concept of using information technology in the field of education. This digital transformation formally refers to the Regulation of the Minister of Research, Technology and Higher Education 51 of 2018. As it is known that through this regulation, the use of information technology is one strategy to answer the challenges of the industrial revolution 4.0 in the education sector. On the other hand, the presence of COVID-19 has accelerated this transformation. Through SE Number 4 of 2020, education is held online. As a result, the smart school concept has become an alternative to maintain the continuity of the implementation of education (Sampebua & Mangiwa, 2017).

Although the application of smart schools in education provides many benefits and advantages, it cannot be separated from challenges and limitations (Al-Badi, Tarhini, & Al-Mawali, 2020). Research (Al-Badi, Tarhini, & Al-Mawali, 2020) and (Majeed & Yussof, 2015) indicate that the challenges in implementing the smart school concept, namely the lack of financial support, lack of human resource competence, technical issues, and refusal to adopt technology. These challenges arise due to changes in paradigms and mechanisms for providing education.

Meanwhile, based on research (Sulistiyani & Budiarti, 2021) it is stated that online learning readiness as a form of smart school is at a ready level with the need for improvement.

Dimensions that require improvement include policy, human resources, and finance. This readiness is influenced by the adoption of online learning which is not yet optimal. Given that smart school is a new concept that certainly brings change, a change management strategy is needed to make its adoption successful. Both from competency adjustments and adaptation to new situations (Recalde & Palau, 2021). Accordingly, a generic model that can be used for smart school has not been established (Sneesi, Jusoh, Jabar, & Abdullah, 2022). A technology adoption framework can be an alternative solution in supporting the adoption of students and teachers to improve learning (Sneesi, Jusoh, Jabar, & Abdullah, 2022).

Based on these conditions, adoption is one of the challenges in the successful implementation of smart schools. Therefore, as a preliminary, this study aims to conduct a literature review related to the IT adoption model in education. The hope is that IT adoption models and variables will be identified. To achieve this goal, there are two research questions as follows:

1. what are the technology adoption Theories for Smart Schools?
2. what are the common variables for Smart School Adoption?

LITERATURE REVIEW

Definition of Smart School

The current teaching and learning process is mainly based on IT resources and many schools choose to digitize the curriculum by converting the traditional way of learning to a new concept called “Smart School” [2]. School is defined as a concept that develops e-learning services applied to schools as a means of interaction between administrative staff, teachers, and students.

Fauzan, states that the smart school concept consists of three pillars that must belong to the school, that is, the provision of physical facilities such as smart classrooms, smart libraries and smart offices [7]. Based on the research of Sulistiyani and Budiarti [4], it is said that the motivation to deploy e-learning as a form of smart school is already at a ready level and needs to be improved. Aspects that need to be improved include policy, human resources, and finance. Similar researchers in other institutions also concluded that the application of e-learning is still not optimal.

Information Technology Adoption Model for Smart School

Various behavioral theories are widely used to examine the end-user's IT adoption process, including the theory of action of reason, the theory of planned behavior, and the acceptance model. technology acceptance, mobile services acceptance model, and theory of non-validation of expectations.

The Technology Acceptance Model (TAM) is the most widely used research model to examine the adoption of information technology. TAM has been a popular and widely used model in various studies related to the IT adoption process [8]. The most recent model or theory is the Unified Technology Acceptance and Use Theory (UTAUT), first proposed by Venkatesh [9].

King and Gribbins mention that in the late 1960s and early 1970s, Fishbein and Ajzen began to develop a theory that helps researchers understand and predict individual attitudes and behaviors [10]. TPB is an extension of TRA, with the addition of variables controlling cognitive behavior, in addition to behaviors and subjective norms [11]. TAM, first introduced by Fred D. Davis in 1989, is an adaptation of TRA specifically designed to model user

acceptance of information systems [12]. The theory of nonconfirmation of expectations, in this model, there are 2 perceived variables that can affect customer satisfaction [13]. The mobile service adoption model is based on TAM and incorporates other factors such as context, trust, initiative, and personal characteristics [14].

RESEARCH METHODOLOGY

The method used in this research study is literature review. This research applies Kitchenham and Charters (Kitchenham & Charters, 2017) guidelines. The stages of literature review will be explained bellow.

Search Process

The literature used in this study focuses on journals and conference. On these stages will be explained the process of choosing the previous studies regarding IT adoption model in education field. Sources selected for the studies search process from the well-known database can be seen in Table 1.

Table 22. Resource of literature search

No	Resource	URL
1	Science Direct	sciencedirect.com
2	Emerald	emeraldinsight.com
3	IEEE Xplore	ieeexplore.ieee.org
4	Google Scholar	scholar.google.com
5	Research Gate	researchgate.net
6	Springer	springer.com

The keyword used for literature search are keywords that related to the research topic of this study, such as: **“IT adoption for education”, “adoption of smart education”, “Adoption of Smart School”, “Factors affecting acceptance of smart education”, “Factors affecting acceptance of smart school”**.

Inclusion and Exclusion Criteria

The inclusion and exclusion criteria to analyze and eliminate the studies will be determined at these stages. Here are the inclusion and exclusion criteria used can be seen in Table 2:

Table 23. Inclusion And Exclusion Criteria

Inclusion Criteria	<ul style="list-style-type: none"> • Journals and conferences published in 2012-2022 • The studies used English • The studies related to IT adoption in Education Field • The studies focus on Factors, Model, framework of IT Adotion
Exclusion Criteria	<ul style="list-style-type: none"> • Studies that discuss IT adoption but not in the education field • Studies are not English • Thesis • Book

Selection Process

At this final stage, the selection process will be done. The selection of studies conducted in four steps. The first step is literature search; At this stage, a literature search will be carried out

in the database based on predetermined keywords. The second step is studies found; the literature is selected based on the relevant title. The third stage is Candidate Studies; literature has been selected based on inclusion and exclusion criteria. And the last stage is Selected studies; this stage is a filtering the literature from candidate studies. The selected literature has been read in its entirety and analyzed whether the literature is in accordance with the research topic. If the literature is in accordance with the research topic, then it will be selected as the literature that would be reviewed. Result of the selection process shown in Table 3 below:

Table 24. Result of Literature Search

Resource	Literature Search	Found	Candidates	Selected
Science Direct	28,510	51	14	5
Emerald	15,000	17	10	5
IEEE Xplore	4076	8	4	0
Google Scholar	784000	21	6	4
Research Gate		27	17	13
Springer	36117	5	3	2

RESULT AND DISCUSSION

The Technology Adoption Theories for Smart Schools

Based on the analysis of 29 papers, 10 adoption models were identified that were used in the smart school context. The ten models include Value based Adoption Model (VAM), Technology Acceptance Model (TAM), Unified Theory of Acceptance and Use of Technology (UTAUT) 2, Innovation Diffusion Theory (IDT), Unified Theory of Acceptance and Use of Technology (UTAUT). , Unified Theory of Acceptance and Use of Technology (UTAUT) 3, Theory of Planned Behavior (TPB), the mobile services acceptance model, smart classroom learning environments (SCLEs) purposed model, Holistic Technology Application Model for Smart School Management, Theory of Reasoned Action (TRA). Details of the frequency of use of the model based on the results of the literature review are presented in figure 1. Most of the models are general models of adoption of existing technologies.

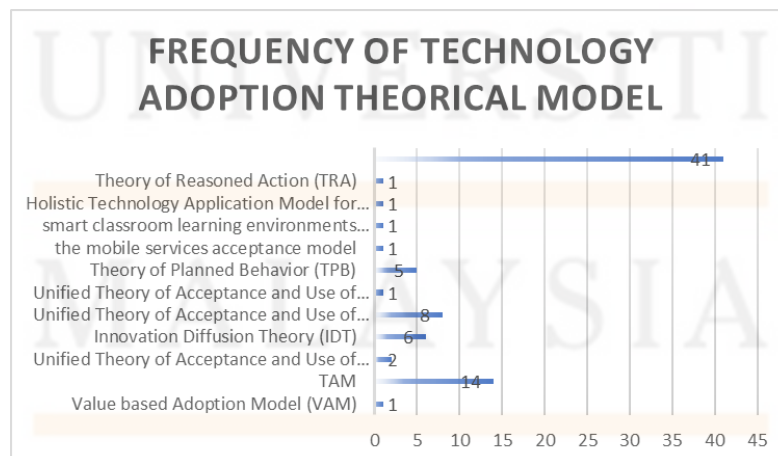

Figure 1. Frequency of Technology Adoption Model

It's just that there are three new models proposed specifically for the smart school context. The three models are the mobile services acceptance model, smart classroom learning environments (SCLEs), Holistic Technology Application Model for Smart School Management.

The literature review shows that TAM is the most widely used technology adoption model in smart schools. A total of 14 studies out of 29 reviewed used TAM in their adoptin analysis. The selection of TAM as a technology adoption model is based on the popularity of the model (Sneesi, Jusoh, Jabar, & Abdullah, 2022). However, in its implementation, TAM is combined with other models. This is because the results of previous studies show that TAM is not sufficient to describe the actual use of technology (Sneesi, Jusoh, Jabar, & Abdullah, 2022). Increased efficiency of resource use, energy savings, decision-making accuracy, service improvement, and risk mitigation are values that can be presented as the impact of smart school adoption (Sneesi, Jusoh, Jabar, & Abdullah, 2022).

The Common Variables for Smart School Adoption

Based on the literature result, there are many variables were identified based on the knowledge obtained from previous study. From the results of the analysis conducted by the researcher, several variables were found through a literature review. The researchers tried to organize and categorizing the technology adoption variables into four schemes according to Sneesi (Sneesi, Jusoh, Jabar, & Abdullah, 2022) themes. Sneesi (Sneesi, Jusoh, Jabar, & Abdullah, 2022) state the four-scheme recognized as: a) Technological specific factors; b) Organizational specific factors; c) environmental specific factors; and d) end user specific factors. The broad themes and their corresponding variables are shown in Table 4.

Table 25. Classification of Variables

Factors	Variables	Source
Technological Specific Factors	Perceived ease of use	(Sneesi, Jusoh, Jabar, & Abdullah, 2022) (Amri & Almaiah, 2021) (Islamoglu, Yurdakul, & Ursavas, 2021) (Chatterjee, Majumdar, Misra, & Damaševičius, 2020) (Jabeen & Sadique, 2020) (Kumar, Osman, Sanmugam, & Rasappan, 2022) (Hamidi & Hamidi, 2018) (Dissanayake & Velananda, 2020) (Zhao, Wang, Li, Zhou, & Li, 2020) (Aziz, Rasdi, & Ahmad Aizuddin Md Rami, 2022) (Abdekhoda, 2021) (Ningsih, Suherdi, & Purnawarman, 2022) (Arpaci, 2017)
	Perceived usefulness	(Sneesi, Jusoh, Jabar, & Abdullah, 2022) (Amri & Almaiah, 2021) (Islamoglu, Yurdakul, & Ursavas, 2021) (Chatterjee, Majumdar, Misra, & Damaševičius, 2020) (Jabeen & Sadique, 2020) (Ho, et al., 2020) (Kumar, Osman, Sanmugam, & Rasappan, 2022) (Hamidi & Hamidi, 2018) (Dissanayake & Velananda, 2020) (Zhao, Wang, Li, Zhou, & Li, 2020) (Abdekhoda, 2021) (Ningsih, Suherdi, & Purnawarman, 2022) (Arpaci, 2017)
	Effective & efficiency	(Amri & Almaiah, 2021)
	security	(Asadi, Abdekhoda, & Nadrian, 2020)
	Trust	(Hamidi & Hamidi, 2018)
	Perceived Enjoyment	(Amri & Almaiah, 2021) (Alzaidi, 2022) (Zhao, Wang, Li, Zhou, & Li, 2020)
	Content Feature	(Ho, et al., 2020)
	Perceived Utility	(Rico-Bautista, et al., 2021)
	System Interactivity	(Jabeen & Sadique, 2020) (Ho, et al., 2020)
	Utilization	(Amri & Almaiah, 2021)

Factors	Variables	Source
	Effort Expectancy	(Chatterjee, Majumdar, Misra, & Damaševičius, 2020) (Gunasinghe, Hamid, Khatibi, & Azam, 2020) (Jalil, Rajakumar, & Zaremohzzabieh, 2022) (Mills, Bolliger, & McKim, 2018) (Reychav, Warkentin, & Ndicu, 2016) (Holzmann, Schwarz, & Audretsch, 2020)
	Performance Expectancy	(Gunasinghe, Hamid, Khatibi, & Azam, 2020) (Samsudeen & Rusith Mohamed, 2019) (Dissanayake & Velananda, 2020) (Jalil, Rajakumar, & Zaremohzzabieh, 2022) (Mills, Bolliger, & McKim, 2018) (Reychav, Warkentin, & Ndicu, 2016) (Holzmann, Schwarz, & Audretsch, 2020)
	Perceived Risk	(Alzaidi, 2022) (Chatterjee, Majumdar, Misra, & Damaševičius, 2020)
	Price Value	(Chatterjee, Majumdar, Misra, & Damaševičius, 2020)
	Usability factors	(Sabi, Uzoka, Langmia, & Njeh, 2016)
	Connectedness	(Wang, Tigelaar, Luo, & Admiraal, 2022)
	Quality of Service	(Mills, Bolliger, & McKim, 2018)
	Privacy	(Asadi, Abdekhoda, & Nadrian, 2020)
	Perceived Playfulness	(Sabi, Uzoka, Langmia, & Njeh, 2016)
	Technology Use	(Lee, Kim, & Jang, 2020)
Organizational Specific Factors	Facilitating Condition	(Islamoglu, Yurdakul, & Ursavas, 2021) (Gunasinghe, Hamid, Khatibi, & Azam, 2020) (Samsudeen & Rusith Mohamed, 2019) (Jalil, Rajakumar, & Zaremohzzabieh, 2022) (Aziz, Rasdi, & Ahmad Aizuddin Md Rami, 2022) (Ningsih, Suherdi, & Purnawarman, 2022) (Holzmann, Schwarz, & Audretsch, 2020)
	Context	(Hamidi & Hamidi, 2018)
	Technical Support	(Jabeen & Sadique, 2020)
	Training and Education	(Arpaci, 2017)
	Educational value	(KIM & KIM, 2013)
	Curriculum	(Lee, Kim, & Jang, 2020)
	knowledge sharing	(Alzaidi, 2022) (Reychav, Warkentin, & Ndicu, 2016) (Arpaci, 2017)
	Cognitive activation	(Wang, Tigelaar, Luo, & Admiraal, 2022)
Environmental Specific factors	Organizational attributes	(Sabi, Uzoka, Langmia, & Njeh, 2016)
	Organization citizenship behavior	(KIM & KIM, 2013)
Environmental Specific factors	Social Influence	(Islamoglu, Yurdakul, & Ursavas, 2021) (Gunasinghe, Hamid, Khatibi, & Azam, 2020) (Jabeen & Sadique, 2020) (Rico-Bautista, et al., 2021) (Asadi, Abdekhoda, & Nadrian, 2020) (Samsudeen & Rusith Mohamed, 2019) (Kumar, Osman, Sanmugam, & Rasappan, 2022) (Huang, Teo, Sánchez-Prieto, García-Peñalvo, & Olmos-Migueláñez, 2019) (Dissanayake & Velananda, 2020) (Jalil, Rajakumar, & Zaremohzzabieh, 2022) (Mills, Bolliger, & McKim, 2018) (Zhao, Wang, Li, Zhou, & Li, 2020) (Aziz, Rasdi, & Ahmad Aizuddin Md Rami, 2022) (Reychav,

Factors	Variables	Source
		Warkentin, & Ndicu, 2016) (KIM & KIM, 2013) (Ningsih, Suherdi, & Purnawarman, 2022) (Holzmann, Schwarz, & Audretsch, 2020)
	External Pressure	(Selim, Eid, & Agag, 2020)
	Culture	(Hamidi & Hamidi, 2018) (Huang, Teo, Sánchez-Prieto, García-Peñalvo, & Olmos-Migueláñez, 2019) (Zhao, Wang, Li, Zhou, & Li, 2020)
	Knowledge Creation and Discovery	(Arpaci, 2017)
	Knowledge Storage	(Arpaci, 2017)
	Knowledge Application	(Arpaci, 2017)
	Ethical considerations	(Aziz, Rasdi, & Ahmad Aizuddin Md Rami, 2022)
	work life Quality	(Samsudeen & Rusith Mohamed, 2019)
End-User Specific Factors	Behavioral Intention	(Amri & Almaiah, 2021) (Islamoglu, Yurdakul, & Ursavas, 2021) (Chatterjee, Majumdar, Misra, & Damaševičius, 2020) (Gunasinghe, Hamid, Khatibi, & Azam, 2020) (Samsudeen & Rusith Mohamed, 2019) (Kumar, Osman, Sanmugam, & Rasappan, 2022) (Hamidi & Hamidi, 2018) (Huang, Teo, Sánchez-Prieto, García-Peñalvo, & Olmos-Migueláñez, 2019) (Jalil, Rajakumar, & Zaremohzzabieh, 2022) (Mills, Bolliger, & McKim, 2018) (Zhao, Wang, Li, Zhou, & Li, 2020) (Aziz, Rasdi, & Ahmad Aizuddin Md Rami, 2022) (Ningsih, Suherdi, & Purnawarman, 2022)
	Self-Efficacy	(Islamoglu, Yurdakul, & Ursavas, 2021) (Jabeen & Sadique, 2020) (Ho, et al., 2020) (Kumar, Osman, Sanmugam, & Rasappan, 2022) (Dissanayake & Velananda, 2020) (Zhao, Wang, Li, Zhou, & Li, 2020) (Ningsih, Suherdi, & Purnawarman, 2022)
	Internet Experience	(Jabeen & Sadique, 2020) (Samsudeen & Rusith Mohamed, 2019)
	Anxiety	(Islamoglu, Yurdakul, & Ursavas, 2021) (Holzmann, Schwarz, & Audretsch, 2020)
	Intention to use	(Rico-Bautista, et al., 2021) (KIM & KIM, 2013)
	Hedonic Motivation	(Samsudeen & Rusith Mohamed, 2019)
	Personal Characters and features	(Dissanayake & Velananda, 2020)
	Self-Management of Learning	(Dissanayake & Velananda, 2020)
	Personal Innovativeness	(Dissanayake & Velananda, 2020) (Mills, Bolliger, & McKim, 2018) (Zhao, Wang, Li, Zhou, & Li, 2020) (Arpaci, 2017)
	Attitude toward use	(Islamoglu, Yurdakul, & Ursavas, 2021) (Rico-Bautista, et al., 2021) (Ho, et al., 2020) (Kumar, Osman, Sanmugam, & Rasappan, 2022) (Zhao, Wang, Li, Zhou, & Li, 2020) (Aziz, Rasdi, & Ahmad Aizuddin Md Rami, 2022) (KIM &

Factors	Variables	Source
		KIM, 2013) (Holzmann, Schwarz, & Audretsch, 2020)
	Teacher Efficacy	(KIM & KIM, 2013)
	Resistance to class	(KIM & KIM, 2013)
	Perceived Behavioral control	(Amri & Almaiah, 2021) (Asadi, Abdekhoda, & Nadrian, 2020)

Based on references, Smart school is defined as a concept of using information technology in the field of education. This digital transformation formally refers to the Regulation of the Minister of Research. From the result of variables mapping, it was found that several variables were common and suitable for the smart school adoption model. Each scheme has variables that suitable smart school adoption.

On organizational specific factors, it is found several variables such as *training and education, educational value, curriculum, and knowledge sharing*. while in environmental specific factors it is found several variables such as *knowledge creation and discovery, knowledge storage, and knowledge applications*. and on the last scheme, End-users specific factors, found several variables such as *self-management of learning, teacher efficacy and resistance to class*.

CONCLUSION

Based on the results of the literature review, 29 papers were identified that match the specified inclusion and exclusion criteria. There are 10 adoption models were identified that were used in the smart school context. The ten models include Value based Adoption Model, Technology Acceptance Model, Unified Theory of Acceptance and Use of Technology 2, Innovation Diffusion Theory, Unified Theory of Acceptance and Use of Technology, Unified Theory of Acceptance and Use of Technology 3, Theory of Planned Behavior, the mobile services acceptance model, smart classroom learning environments (SCLEs) purposed model, Holistic Technology Application Model for Smart School Management, Theory of Reasoned Action. TAM is the most widely used technology adoption model in smart schools. From the 51 variables found, there are 10 variables that are suitable the context of smart schools such as training and education, educational values, curriculum, knowledge sharing, knowledge creation and discovery, knowledge storage, knowledge applications, self-management of learning, teacher efficacy and resistance to class.

REFERENCES

- Abdekhoda, M. (2021). Effective Factors in Adopting Electronic Books E books by Students in Electronic Era. *DESIDOC Journal of Library & Information Technology*.
- Al-Badi, A., Tarhini, A., & Al-Mawali, H. (2020). The Challenges Faced During the Implementation of Smart Schools in Oman. In *ICT for an Inclusive World*. Springer.
- Al-Suqri, M., Al-Aufi, A., Chakraborty, M., & Rashdi, S. (2015). Venkatesh et al.'s Unified Theory of Acceptance and Use of Technology (UTAUT) (2003). In *Information Seeking Behavior and Technology Adoption: Theories and Trends* (pp. 220-236).
- Alzaidi, M. S. (2022). Understanding Factors Affecting Smart Classroom Adoption: An Empirical Investigation in Saudi Arabia Higher Education. *International Journal of Customer Relationship Marketing and Management*, 13(1).

- Amri, M. A., & Almaiah, M. A. (2021). Sustainability Model for Predicting Smart Education Technology Adoption Based on Student Perspectives. *Int. J. Advance Soft Compu. Appl.*, 13(2), 60-77.
- Arpaci, I. (2017). Antecedents and consequences of cloud computing adoption in education to achieve knowledge management. *Computers in Human Behavior*.
- Asadi, Z., Abdekhoda, M., & Nadrian, H. (2020). Understanding and predicting teachers' intention to use cloud computing in smart education. *Interactive Technology and Smart Education*, 17(1), 14-27.
- Aziz, F., Rasdi, R. M., & Ahmad Aizuddin Md Rami. (2022). Factors Determining Academics' Behavioral Intention and Usage Behavior Towards Online Teaching Technologies During Covid-19: An Extension of the UTAUT. *iJET*, 17(1).
- Chatterjee, S., Majumdar, D., Misra, S., & Damaševičius, R. (2020). Adoption of mobile applications for teaching-learning process in rural girls' schools in India: an empirical study. *Education and Information Technologies*, 25, 4057-4076.
- Chau, C., & Hu, P. (2002). Investigating healthcare professionals' decisions to accept telemedicine technology: an empirical test of competing theories. *Information & Management*, 39(4), 297-311.
- Davis, F. D. (1989). Perceived Usefulness, Perceived Ease of Use, and User Acceptance of Information Technology. *MIS Quarterly*, 13(3), 319-340.
- Dissanayake, D. M., & Velananda, Y. L. (2020). Critical Success Factors for Performance Oriented M-Learning in Sri Lanka. *Journal of Educational and Social Research*, 10(2).
- Fauzan, M. R. (2021). Analisis Konsep Smart School Studi Kasus SMK Negeri 1 Cimahi. *Universitas Pendidikan Indonesia*.
- Gao, S., Krogstie, J., & Ther, G. (2008). Mobile Services Acceptance Model. *2008 International Conference on Convergence and Hybrid Information Technology, ICHIT 2008*, (pp. 446-453).
- Gregg G. Van Ryzin. (2006). Testing the Expectancy Disconfirmation Model of Citizen Satisfaction with Local Government. *Journal of Public Administration Research and Theory*, 16(4), 599-611.
- Gunasinghe, A., Hamid, J. A., Khatibi, A., & Azam, S. F. (2020). The adequacy of UTAUT-3 in interpreting academician's adoption to e-Learning in higher education environments. *Interactive Technology and Smart*, 17(1), 86-106.
- Hamidi, H., & Hamidi, H. (2018). Analysis of the essential factors for the adoption of mobile learning in higher education: A case study of students of the University of Technology. *Telematics and Informatics*, 35, 1053-1079.
- Ho, N. T., Sivapalan, S., Pham, H. H., Nguyen, L. T., Pham, A. T., & Dinh, H. V. (2020). Students' adoption of e-learning in emergency situation: the case of a Vietnamese university during COVID-19. *Interactive Technology and Smart Education*.
- Holzmann, P., Schwarz, E. J., & Audretsch, D. B. (2020). Understanding the determinants of novel technology adoption among teachers: the case of 3D printing. *The Journal of Technology Transfer*, 259-275.
- Huang, F., Teo, T., Sánchez-Prieto, J. C., García-Peñalvo, F. J., & Olmos-Migueláñez, S. (2019). Cultural values and technology adoption: A model comparison with university teachers from China and Spain. *Computers & Education*, 133, 69-81.
- Islamoglu, H., Yurdakul, I. K., & Ursavas, O. F. (2021). Pre-service teachers' acceptance of mobile-technology-supported learning activities. *Education Tech Research Dev*, 69, 1025-1054.
- Jabeen, S., & Sadique, Z. (2020). FACTORS INFLUENCING THE ADOPTION OF E-LEARNING IN EDUCATIONAL AND CORPORATE SECTORS. *EDULEARN20 Conference*.

- Jalil, H. A., Rajakumar, M., & Zaremohzzabieh, Z. (2022). Teachers' Acceptance of Technologies for 4IR Adoption: Implementation of the UTAUT Model. *International Journal of Learning, Teaching and Educational Research*, 21(1), 18-32.
- KIM, S.-Y., & KIM, M.-R. (2013). COMPARISON OF PERCEPTION TOWARD THE ADOPTION AND INTENTION TO USE SMART EDUCATION BETWEEN ELEMENTARY AND SECONDARY SCHOOL TEACHERS. *The Turkish Online Journal of Educational Technology*, 12(2).
- King, R. C., & Gribbins, M. L. (2002). Internet technology adoption as an organizational event: an exploratory study across industries. *35th Annual Hawaii International Conference on System Sciences*. Hawaii.
- Kitchenham, B. A., & Charters, S. (2017). *Guidelines for performing systematic literature reviews in software engineering* (10th ed.).
- Kumar, J. A., Osman, S., Sanmugam, M., & Rasappan, R. (2022). Mobile Learning Acceptance Post Pandemic: A Behavioural Shift among Engineering Undergraduates. *Sustainability*, 14.
- Lee, J., Kim, Y.-L., & Jang, E. Y. (2020). Becoming a Smart School: A Holistic View of Technology Integration. *International Journal of Innovation, Creativity and Change*, 14(5).
- Lee, Y., Kozar, K. A., & Larsen, K. (2003). The technology acceptance model: past, present and future. *Communications of the Association for Information Systems*, 12(50), 28.
- Majeed, Z. S., & Yussof, Z. S. (2015). Are We “Smarter” Now? Case Study of Smart School Implementation in a Developing Nation. *Journal of Studies in Education*, 5(3), 236-258.
- Mills, D. J., Bolliger, D. U., & McKim, C. (2018). Modification and Revalidation of the M-Learning Acceptance Model. *CALL-EJ*, 19(1), 60-74.
- Ningsih, S. K., Suherdi, D., & Purnawarman, P. (2022). SECONDARY SCHOOL TEACHERS' PERCEPTIONS OF MOBILE TECHNOLOGY ADOPTION IN ENGLISH AS A FOREIGN LANGUAGE LEARNING: TRENDS AND PRACTICES. *International Journal of Education and Practice*, 10(2), 160-170.
- Recalde, J. M., & Palau, R. (2021). Smart schools on the way: How school principals from Catalonia approach the future of education within the fourth industrial revolution. *Learning Environments Research*.
- Reychav, I., Warkentin, M., & Ndicu, M. (2016). Tablet Adoption with Smart School Website Technology. *Journal of Computer Information Systems*, 56(4), 280-287.
- Rico-Bautista, D., Guerrero, C. D., Collazos, C. A., Maestre-Góngora, G., Hurtado-Alegría, J. A., Medina-Cárdenas, Y., & Swaminathan, J. (2021). Smart University: A vision of technology adoption. *Revista Colombiana de Computación*, 22(1), 44-55.
- Sabi, H. M., Uzoka, F.-M. E., Langmia, K., & Njeh, F. N. (2016). Conceptualizing a model for adoption of cloud computing in education. *International Journal of Information Management*, 183-191.
- Sampebua, M., & Mangiwa, S. (2017). The Design Smart School Application to Increase Education in Junior High School. *International Journal of Computer Science and Information Security*, 15(10), 154-165.
- Samsudeen, S. N., & Rusith Mohamed. (2019). "University students' intention to use e-learning systems: A study of higher educational institutions in Sri Lanka. *Interactive Technology and Smart Education*.
- Selim, H. M., Eid, R., & Agag, G. (2020). Understanding the role of technological factors and external pressures in smart classroom adoption. *Journal of Education & Training's*.
- Sneessl, R., Jusoh, Y. Y., Jabar, M. A., & Abdullah, S. (2022). Revising Technology Adoption Factors for IoT-Based Smart Campuses: A Systematic Review. *Sustainability*, 14.

- Sulistiyani, E., & Budiarti, R. P. (2021). Analysis of Online Learning Readiness Level at Universitas Nahdlatul Ulama Surabaya (UNUSA). *International Journal of Innovation in Enterprise System*, 5, 23-34.
- Wang, J., Tigelaar, D. E., Luo, J., & Admiraal, W. (2022). Teacher beliefs, classroom process quality, and student engagement in the smart classroom learning environment: A multilevel analysis. *Computers & Education*.
- Zhao, Y., Wang, N., Li, Y., Zhou, R., & Li, S. (2020). Do cultural differences affect users' e-learning adoption? A meta-analysis. *British Journal of Educational Technology*.



Effect of E-Leadership on Employees Performance in a Work from Home Setup during Crisis

Juliza Adira binti Mohd@Ariffin
University of Putra Malaysia, Serdang, Selangor
gs58605@student.upm.edu.my

Ahmad Aizuddin bin Md Rami
University of Putra Malaysia, Serdang, Selangor
ahmadaizuddin@upm.edu.my

ABSTRACT

The covid-19 crisis, which hit the world at the end of 2019, created a new history for most organisations, as most had to implement working from home (WFH) to stop the epidemic from spreading in the community. WFH means that employees perform tasks from their respective homes, and that interaction between leader and employee occurs virtually throughout that time. Nowadays, although the pandemic situation has turned to endemic, but there are some organizations that are still comfortable practicing WFH in a situation that requires it and this may be a popular practice for some organizations in the future. Considering the effect of e-leadership on employees, this study was conducted to determine the effect of e-leadership on employee job performance in a work from home setup. The researcher employed descriptive and causal research designs. This study includes three departments from Malaysia's Ministry of Education and a total of 125 middle leaders as a respondents. The survey was done by sending the Google form link via emailed to the employees. Descriptive and Regression analysis was used to evaluate the collected data. The research found out that e-leadership positively and significantly affects employee job performance. The findings of this study can help organisations understand the importance of empowering their leaders in the implementation of e-leadership, which can have an impact on employee job performance.

Keywords: crisis leadership; e-leadership; employee performance; work from home

INTRODUCTION

The world today is volatile, uncertain, complex, and ambiguous (VUCA). Leadership agility and adaptability have evolved into skills required of leaders in the VUCA world (Amin, 2020). Leaders must frequently use competencies that they have never used before in such situations. There are several types of crises that have occurred and affected the MOE. One of the crises that occurred and involved MOE was an air pollution crisis that occurred in Pasir Gudang, Johor, as a result of illegal toxic waste in Sungai Kim Kim. Besides that, there is also a crisis that occurs on a large scale and involves the entire country including the MOE which is the spread of the COVID-19 epidemic, which began at the end of 2019, prompting the government to implement a variety of measures to halt the virus's rapid spread in the first quarter of 2020. This includes closing down businesses, implementing health protocols, and restricting people's mobility. Not only in Malaysia, but half of the workforce in high-income regions of the world, such as North America and Western Europe, has been able to work from home (WFH) throughout the pandemic.

WFH is one of the workplace strategies used by companies capable of ensuring their operations' survival and continuity. WFH is defined as a flexible working strategy that is not limited by location, technical communication type, or time constraints (Cabrera, E.M., 2020). Actually, based on the past literature, organizations began implementing WFH in the 1970s,

and several studies have now been conducted to investigate the effects of WFH. In Malaysia, as the pandemic Covid-19 spread from 2019 to 2021 and the number of positive cases increased, the majority of organisations, including the MOE, decided to close all of their offices and institutions across the country and implement work-from-home policies on a large scale.

Evidence before the pandemic times suggests that WFH can improve life and work in several ways (Weitzer, J. et al, 2021). Not only that, more exciting findings from the other past research found that WFH can also help to mitigate the negative effects of social isolation, as well as work-family and work-life balance conflicts (Contreras, F. et al. 2020). WFH allows employees more flexibility in dealing with family matters because they can work from anywhere and everywhere, strengthening the family environment and allowing them to coordinate the autonomy of time management and their personal and work tasks. However, all these good consequences need great pay. All those positive consequences will be demonstrated only if employees receive good leadership support (Irwanto et.al, 2021).

Given the importance of leadership support for employees in implementing WFH, the purpose of this study was to determine the impact of e-leadership on employee job performance who had implemented WFH during a crisis. This study focuses on e-leadership implemented by middle leaders. Middle leaders in the MOE are members of a managerial and professional group who hold positions such as Deputy Director or Chief Assistant Director.

When discussing the role of a leader in an educational institution, including crisis research, all previous studies usually only involved the director, principal, and headmaster (De Nobile, 2018) and very little research is conducted on middle leaders, despite the fact that the roles of middle leaders are critical for all organisations. Middle leaders, according to Malik et al. (2011), are constantly under stress from both sides, with lower leaders complaining, pressing, and demanding resources and rewards, while senior management is giving tough deadlines due to the industry's cutthroat competition. Furthermore, this study also choose crises as a focus of study because, in the context of HRD, Raka (2019) agreed that research on leaders in crisis management in HRD academic discipline is still underexplored when compared to other academic disciplines such as management and psychology.

Research Question and Research Objective

This study was conducted to answer the research question as follows:

RQ: To what extent does e-leadership influence employees' job performance when performing work from home during a crisis?

While also to achieve the following research objective:

RO: To measure e-leadership influences employees' job performance when performing work from home during a crisis.

LITERATURE REVIEW

Crisis and e-leadership

The word crisis refers to the deep value, rational, sound judgments and decisions that a leader needs to immediately undertake, using all the power and knowledge that he possesses (Benaden et al., 2016). In the field of Human Resource Development (HRD), a crisis is defined as an unexpected event that can cause significant changes in many aspects either in terms of

individuals or organizations (Wang & Hutchins, 2010). Leadership in organizations requires ability, especially in a crisis environment.

Even if a leader has extensive experience in leadership, it may not work if he or she is unable to handle panic or critical situations during a crisis, as Dirani et al. (2020) reported in their study, which stated that news and social media have exposed how some leaders are failing in their efforts to save organisations and jobs during a crisis, and what is missing, is a lack of competencies among leaders to deal with the duration, severity, and duration of the crisis.

Another challenge is when crisis leadership must be implemented through e-leadership. E-Leadership is a leadership strategy that allows leaders to shape leadership through the use of technology. E-leadership necessitates a wide range of abilities. The main role of the leader in any leadership style, including e-leadership, is to achieve the company's mission and vision, guide and motivate his team, and empower employees to achieve the organization's goals. In this regard, leaders who practise e-leadership face unique challenges, particularly during crises, because they must meet the same key performance indicators as those set by the organisation when practising face-to-face leadership (Iriqat & Khalaf, 2017). Some leaders are not able to use their ability to influence others in an electronic setting.

Employee Job Performance

Job performance refers to how well (in terms of quality and quantity) an employee performs the tasks specified in his or her job responsibilities (Jiang, H. et. al, 2021). Job performance can also be defined as an achievement-related behaviour with an evaluative component, i.e. how well an employee meets general organisational performance expectations. Research was conducted by Johari, J. et. al (2022) found that competencies of leadership significantly and positively influenced job performance. Another studies conducted by Park, J et.al (2021) and Bieńkowska, A. et.al (2022) also found that leadership style and leaders behaviour do affected employees job performance.

When discussing implementation of e-leadership among leaders especially during WFH, the effect of employees job performance when dealing with e-leadership need to be considered. Al Butt et.al (2022) found that, some of the leaders felt difficulty in executing the functions of leadership during implementing e-leadership like supervision and influencing team members in e-environment. There are so many complexity arises as the leadership responsibilities are shifted to e-environment, like creating & sharing vision, reinforcing the values, engaging and motivating the team members to perform and managing change while working electronically (Darics, E., 2020). This issue attracted the interest of researchers to produce this study to see the impact of e-leadership on employee job performance.

METHOD

The researcher used the quantitative research method to collect data through a survey. The data was analysed using descriptive analysis which is frequency and percentage to describe the respondents' demography and simple linear regression analysis to determine whether the implementation of e-leadership among middle leaders during the crisis have influenced employee in term of their job performance. A p-value of $<.05$ signifies that the effect is significant. On the other hand, a p-value of $>.05$ signifies that the effect is not significant. The data was analysed by using the current version of SPSS software.

The survey questionnaire was adapted from an earlier study conducted by E.M. Cabrera (2022). The questionnaire was divided into two (2) sections. The first section contained the demographic information of the respondents and the second section contained the questions of

the related variable. The validity of the instrument was made by involving 3 experts while the reliability of the instrument was tested through the implementation of a pilot test. Nunally and Bernstein (1994) argue that values of reliability coefficients above 0.6 are acceptable and considered.

The total population is 124 employees who have experience WFH setup during a crisis with supervision from their middle leader. This total of 124 employees is from three (3) departments under MOE. From 124 of the total population, 94 samples were drawn by using a simple random sampling method. The sample was calculated using Raosoft Sample Calculator. The questionnaire was distributed to all respondents online via Google Forms.

DATA ANALYSIS

The data sample used met the assumption for performing regression analysis, that is, the sample data was drawn at random and met the condition of data normality. The following is the hypothesis that has been developed:

Research Hypothesis

H0: There is no significant relation between e-leadership and employee job performance while working from home during a crisis.

H1: There is a significant relation between e-leadership and employee job performance while working from home during a crisis.

Table 1. Demographic of Respondents (n = 94)

Demographic Characteristic	Frequency	Percentage
Gender		
Male	42	44.7
Female	52	55.3
Years of Service in MOE		
Less than 1 year	6	6.4
1 year	11	11.7
2 years	31	33
3 years	33	35.1
4 years and above	13	13.8

Table 4.1 shows the demographic background of the respondent. Of the total of 94 respondent, 42 (44.7%) is male and the rest 52 (55.3%) is female. The majority of respondents have been working for around 2-3 years (68.1%) with their current department.

Table 2. The Influence of E-Leadership on Employees Job Performance

Model		Unstandardized Coefficients		Standardized Coefficients		p-value.	Interpretation
		B	Std. Error	Beta	t-value		
1	(Constant)	3.021	.295		10.229	.000	
	E-Leadership	.396	.060	.568	6.626	.000	Significant
$R^2 = 0.323$							

Note: a. Dependent Variable: Employee Work Performance

Table 4.2 the regression matrix showing e-leadership as a predictor variable of work motivation. The result shows that the value of $p < 0.05$ ($p = 0.0000$), proved that e-leadership positively and significantly affects employee work performance. Therefore, H1 is accepted while H0 is rejected. The regression coefficient value (R Square) for these two variables is 0.323. This means that the e-leadership variable contributes up to 32.3% of the change in the dependent variable, which is employee work performance. The findings leads to the conclusion that, as the quality of e-leadership improves, so will employees job performance. Furthermore, when employees are satisfied with management's e-leadership, will make them perform better in their job.

DISCUSSION

According to the findings of this study, e-leadership has a positive and significant impact on employee job performance. This supports the claim that as the quality of e-leadership improves, so will employee job performance. Furthermore, when employees are pleased with the e-leadership of the middle leaders, they will perform their job well, even in crises. This finding is consistent with previous research such as Basu, R. (2022), Wolor, C.W. et al (2020), and Hena & Gupta (2015), who believe that e-leadership, like face-to-face leadership, also can influence employee motivation and participation in company activities which finally will lead them to better job performance.

Patsorn (2021) found that reading non-verbal responses of employees is challenging in a virtual work setting. Other than that, there are numerous other challenges that leaders may face when implementing e-leadership during a crisis, such as failing to communicate a problem or not having enough information to make an informed decision (J.A. Mohd & A.A. Md Rami, 2022). Taking into account all these challenges, middle leaders must develop specific skills to master the competencies in conducting e-leadership. Middle leaders must always believe that the great leaders are concerned with connecting with the people they lead and always inspiring their subordinates with various relevant strategies.

Besides the middle leaders itself, an organizations also must constantly monitor and assist middle leaders in improving their competencies in implementing e-leadership, particularly in times of crisis. An organisation must consider e-leadership when planning future courses or training. An organization must aware regarding the importance of understanding e-leadership in the context of crises among their leaders is important, considering that normal situations and crisis usually demands a different job scope from leaders. In today's VUCA world, crises can occur at any time and in a variety of ways. As a result, every organisation must prepare its leaders to always be effective in leading subordinates, even when a crisis occurs. In today's uncertain world, the need for e-leadership to be implemented on a large scale in organisations when a crisis strikes is not excluded, so it is an organization's obligation to ensure that e-leadership also becomes one of the main focuses in developing human resources in their organisation.

CONCLUSION AND LIMITATION

This article has successfully identified that there is an influence of e-leadership on employee job performance during a crisis. The findings from this study, help to enhance the literature in the field of e-leadership, employee job performance, crisis management and also literature involving middle leaders. Furthermore, the findings on this study show that organisations

should pay more attention to the competency of their leaders when implementing e-leadership in their organisations because it can have a significant impact on their employees.

This study, however, has a limitation. This research is limited to the MOE department. Therefore, we encourage future researchers to replicate this research on different populations in order to enrich and expand the literature. In addition, we also encourage future researchers to investigate the impact of e-leadership on other dependent variables such as employee motivation, organisational performance, and so on.

REFERENCES

- Amin Senin, (2020). Leading School in A VUCA World. *1st International Conference On Educational Leadership And Management*. Institut Aminuddin Baki.
- Basu, R. (2022). Impact Of Digital Platform On E-Leadership. *Journal of Positive School Psychology*, 6(2), 882-887.
- Bieńkowska, A., Koszela, A., Ludwikowska, K., & Tworek, K. (2022). Turnover-mitigating effect of servant leadership on job performance. *Engineering Management in Production and Services*, 14(2), 67-81. doi: 10.2478/emj-2022-0017
- Butt, A. I., Aziz, F., & Batool, T. (2022). E-Leadership Challenges & Opportunities For Pakistani Universities. *Webology (ISSN: 1735-188X)*, 19(2)
- Cabrera, E. M. (2022). *Effect of E-Training, E-Leadership, Work-Life Balance, and Work Motivation on Performance of Employees in a Work from Home Setup*. Master Thesis.
- Contreras, F., Baykal, E., & Abid, G. (2020). E-leadership and teleworking in times of COVID-19 and beyond: What we know and where do we go. *Frontiers in Psychology*, 11, 590271.
- Darics, E. (2020). E-leadership or How To Be Boss In Instant Messaging?The role of nonverbal communication. *International Journal of Business Communication*, 57(1), 3-29. <https://doi-org.sdl.idm.oclc.org/10.1177/2329488416685068>
- De Nobile, J. (2018) Towards a Theoretical Model of Middle Leadership in Schools. *School Leadership & Management*, 38(4), 395-416. <https://doi:10.1080/13632434.2017.1411902>
- Dirani, K. M., Abadi, M., Alizadeh, A., Barhate, B., Garza, R. C., Gunasekara, N., Ibrahim, G., & Majzun, Z. (2020). Leadership Competencies and The Essential Role of Human Resource Development in Times of Crisis: A Response to Covid-19 Pandemic. *Human Resource Development International*, 00(00), 380–394. <https://doi.org/10.1080/13678868.2020.1780078>
- Hema, G., & Gupta, S. M. (2015). Adversity Quotient for Prospective Higher Education. *The International Journal of Indian Psychology*, 2(3). [Indonesian]
- Hemin Jiang, Mikko Siponen & Aggeliki Tsohou (2021): Personal use of technology at work: a literature review and a theoretical model for understanding how it affects employee job performance, *European Journal of Information Systems*, DOI: 10.1080/0960085X.2021.1963193
- Iriqat, R. A. M., & Khalaf, D. M. S. (2017). Using E-Leadership as a Strategic Tool in Enhancing Organizational Commitment of Virtual Teams in Foreign Commercial Banks in North West Bank -Palestine. *International Journal of Business Administration*, 8(7), 25-32. <https://doi.org/10.5430/ijba.v8n7p25>
- Irawanto, Dodi Wirawan, Khusnul Rofida Novianti, and Kenny Roz. 2021. Work from Home: Measuring Satisfaction between Work–Life Balance and Work Stress during the COVID-19 Pandemic in Indonesia. *Economies* 9: 96. <https://doi.org/10.3390/economies9030096>

- Johari, J., Shamsudin, F.M., Zainun, N.F.H., Yean, T.F. and Yahya, K.K. (2022), "Institutional leadership competencies and job performance: the moderating role of proactive personality", *International Journal of Educational Management*, Vol. 36 No. 6, pp. 1027-1045. <https://doi.org/10.1108/IJEM-07-2021-0280>
- Joshua D. Jensen, 2018. "Employee Motivation: A Leadership Imperative," *International Journal of Business Administration*, *International Journal of Business Administration*, Sciedu Press, vol. 9(2), pages 93-98, March
- Malik, S. H., Hassan, H., & Aziz, S. (2011). *Path Goal Theory : A Study Of Employee Job Satisfaction In Telecom Sector*. 2011 International Conference on Management and Service Science.
- Mohd (a) Ariffin, J.A., Rami, A.A.M. (2022). *Digital Learning Crisis Management Competencies Among Leaders During the Covid-19 Pandemic*. In: Hamdan, A., Hassaniien, A.E., Mescon, T., Alareeni, B. (eds) *Technologies, Artificial Intelligence and the Future of Learning Post-COVID-19*. Studies in Computational Intelligence, Vol 1019. Springer, Cham. https://doi.org/10.1007/978-3-030-93921-2_6
- Park, J., Han, S.J., Kim, J. and Kim, W. (2021). Structural Relationships Among Transformational Leadership, Affective Organizational Commitment, and Job Performance: The Mediating Role of Employee Engagement. *European Journal of Training and Development*, Vol. ahead-of-print No. ahead-of-print. <https://doi.org/10.1108/EJTD-10-2020-0149>
- Patsorn, S. (2021). *Understanding the challenges of e-leadership: how to lead people amid Covid-19 outbreak in food and beverage industry: Thailand*. Submitted to the College of Mgt, Mahidol University for the degree of Master of Management.
- Raka M. Bhaduri, (2019). Leveraging Culture and Leadership in Crisis Management. *European Journal of Training and Development*. <https://doi.org/10.1108/ejtd-10-2018-0109>
- Wang, J., & Hutchins, H. M. (2010). Crisis Management in Higher Education: What Have We Learned from Virginia Tech?. *Advances In Developing Human Resources*, 12(5), 552–572. <https://doi.org/10.1177/152342231039443>
- Weitzer, J., Papantoniou, K., Seidel, S., Klösch, G., Caniglia, G., Laubichler, M., ... & Schernhammer, E. (2021). Working from home, quality of life, and perceived productivity during the first 50-day COVID-19 mitigation measures in Austria: a cross-sectional study. *International archives of occupational and environmental health*, 94(8), 1823-1837.
- Wiradendi Wolor, C., Solikhah, S., Fidhyallah, N. F., & Lestari, D. P. (2020). Effectiveness of e-training, e-leadership, and work life balance on employee performance during COVID-19. *Journal of Asian Finance, Economics and Business*, 7(10).
- Wolor, C., Solikhah, S., Fidhyallah, F., & Lestari, D. P., (2020) Effectiveness of E-Training, E-Leadership, and Work-Life Balance on Employee Performance during COVID-19. *Journal of Asian Finance, Economics and Business Vol 7 No 10 (2020) 443–450*

Managing Governance and Development in A Multi-Ethnic Society: A Thematic Review

Khairol Anuar Kamri

*Pusat Pengajian Umum dan Kokurikulum, Universiti Tun Hussein Onn Malaysia
khairol@uthm.edu.my*

Aizathul Hani Abd Hamid

*Pusat Pengajian Umum dan Kokurikulum, Universiti Tun Hussein Onn Malaysia
aizahani.hamid@gmail.com*

ABSTRACT

Good governance and development are important in managing ethnic diversity. This is because each ethnic group in a community will face competition for resources and also social status in the community. The focus of governance in this diverse society should not be solely focused on economic growth. Growth needs to be distributed fairly and transparently to guarantee the quality of life and reduce social inequality in a multi-ethnic society. There is various concern in managing governance and development in a multi-ethnic society. This paper aims to identify the comprehensive concerns when managing governance and development in multi-ethnic society by thematic review method. This paper will review the factor of governance and development in multi-ethnic societies in six years' latest studies. This paper uses the PRISMA guideline to systematically choose and review the past studies' results. This paper's result is significant to develop a new and comprehensive framework of governance and development in managing a multi-ethnic society. This paper consists of five important parts which are the introduction that will explain the concept of governance and development in a multi-ethnic society, the methodology part which will show the systematic method in this study, the results of the thematic review, the discussion of this study results and the conclusion part that will suggest future research based on this paper discussion.

Keywords: *development, diversity, ethnicity, governance, multi-ethnic*

INTRODUCTION

Theoretically, building a nation requires a country that is effective and able to cooperate with its community. This is often referred to as governance in the field of community development and public administration. In short, governance covers all activities carried out by a government whether democratically elected by the people or through the conquest of power by military groups. The governance of a government is closely related to competent, efficient, and effective administration in providing quality life needs to the people. These life needs include basic human needs such as food, clean water sources, health care, education, protection from threats, legislation, and other basic life needs (Jenkins et al., 2008).

Apart from that, governance also covers the network between institutions and also the relationship with the community. The community should have a medium to express their views, communicate with the government, and ensure that community interests or public interests are reflected in public policies. Governance also includes political administration affairs in the country because the relationship between the people and politicians and the relationship between politicians is an important dimension in governance. Furthermore, governance does not only involve the cabinet, services, and civil servants, authorities whether local or federal but also plays a role in ensuring the transparency of the legal system, elections, and any management of governmental or non-governmental organizations (Jenkins et al., 2008).

Governance perspectives have been presented through various labels such as local governance, international governance, corporate governance, and modern governance. However, we need to know what the true meaning of governance itself is. The United Nations Development Program (UNDP 1997) has defined governance as the exercise of the economic, political, and administrative authority to manage a country's affairs at all levels (Elahi, 2009). Based on this definition, governance includes mechanisms, processes, and institutions in the administration of a country. The World Bank (1993) defines governance as how power is exercised in the management of a country's economic and social resources for development. This means that the World Bank has referred to governance as the way power is used to manage national development. In this regard, the World Bank has also distinguished three main elements in governance, namely:

- a. Form of political regime.
- b. The process of authority is carried out in the economic and social management of the country for development.
- c. Government capacity to design, formulate and implement policies and functions.

The British Council has emphasized that the concept of governance is broader than government. Governance in this sense refers to the process by which elements in society obtain and exercise power, authority, and influence and enact policies and decisions related to public life and social improvement. According to the British Council, governance involves interaction between the activities of formal institutions and various parties in civil society.

According to Hernandez (1999), governance can be referred to as how organizations, whether in the form of families, communities, civil society, companies, countries, continents, or global organizations are managed. It involves a set of principles and rules that define the organizational structure and the responsibilities, accountability, functions, and powers of the governing party in the organization.

There are so many different views on this definition that it is so broad in scope. In general, it can be said that governance is a process of decision-making and decision-implementation. It also involves formal and informal factors in a society. Therefore, governance can be good or bad depending on the practice carried out.

Today, good governance is one of the concepts that is often talked about in the field of administration. It is a new form of management implementation that leads to effectiveness in the public sector. In addition, it is also seen as a form of performance criteria for a government. Good governance is a term that can be used to describe a dynamic government. In addition to trying to meet the needs of various parties, public administration also constantly changes along with time and global changes. This enables it to address current challenges while addressing future changes (Evers et al., 2014).

The interpretation of the concept of good governance is diverse but covers almost the same thing. Netherlands Development Assistance (NEDA) sees good governance as the transparent and accountable exercise of power toward the population. NEDA considers good governance to be the domain of government. However, the existence of good governance also depends on the input of the private sector and civil society. Good governance is the process of formulating and implementing policies through mutual agreement between various parties aimed at improving the quality of life of the entire community that focuses on the result. Therefore, good governance is an approach that can be used to achieve a better standard of

living such as better wages, education, health services, social security, political stability, material facilities, and spiritual development.

It should be emphasized that these characteristics of good governance have generally been universally accepted. However, its application to different societies must be according to the suitability of a country or society itself. For example in terms of equity where some countries consider it as giving equal rights to all ethnicities while for some countries it refers to socio-economic balancing between various ethnicities in the sector. Therefore, it is necessary to determine suitability first before implementing it so that it can achieve the desired goal.

Good governance and development are important in managing ethnic diversity. This is because each ethnic group in a community will face competition for resources and also social status in the community. The focus of governance in this diverse society should not be solely focused on economic growth. Growth needs to be distributed fairly and transparently to guarantee the quality of life and reduce social inequality in a multi-ethnic society. Nowadays, governance and development in multi-ethnic communities are often emphasized in the discussion of building the progress of a country. Community management in western countries before, especially before the 1970s, was more focused on the majority community of a country. The western political system at that time did not pay deep attention to the management of the diversity of groups, ethnicities, races, and cultures in their country (Grishaeva, 2012).

The increasing arrival of immigrants from all over the world to western countries causes the process of cultural assimilation to no longer to be the absolute answer to the management of existing ethnic diversity. Minority groups and migrants began to isolate themselves instead of assimilating with the local culture. It is this alienation from the current local development that will cause radical actions from these marginalized groups that will ultimately affect the development of developed countries. Therefore, the issue of governance and development in multi-ethnic societies began to receive attention and focus, especially in western countries (Tiranjani, 2010). There is various concern in managing governance and development in a multi-ethnic society. Therefore, this article will further identify the elements of governance and development that focus on the management of communities of various ethnicities based on studies that have been carried out in the last six years through the thematic review method. This article will answer the question of what elements are taken into account in the governance and development of multi-ethnic communities.

METHODOLOGY

This section will go into more detail about how the article's components for governance and development in multi-ethnic society were extracted. The reviewer applied the PRISMA approach, which included tools for gathering and filtering the article, eligibility and exclusion standards chosen for this study, a systematic review procedure that comprises eligibility determination and eligibility screening, data abstraction, and content analysis.

PRISMA

The review followed the PRISMA Statement standards (Preferred Reporting Items for Systematic Reviews and Meta-Analyses). The PRISMA is utilized because it may define a precise research topic that enables a systematic review process. It also can quickly scan a vast database of data. Second, it can filter the article by utilizing inclusion and exclusion criteria to

sort the articles according to the reviewer's study question. PRISMA enables an extensive study of the elements associated with governance and development in a multi-ethnic community.

Resources

Scopus is the journal database source used for this review. The primary database for this article's thematic review is Scopus. It was introduced in 2004 and currently has more than 10,000 publishers worldwide. It spans a broad range of academic disciplines, including social science, health science, physical science, and agriculture.

Eligibility and Exclusion criteria

First, for this review, only article journals with empirical data were chosen. The conference proceedings, book series, review article, and book were not included. Second, to improve comprehension of the entire content, searching was limited to English-language study. Reading non-English periodicals may lead to a language barrier and challenging translations. Third, this evaluation only considers the most recent six years of publication (between 2017 and 2022) because there are so many papers about governance and development in a multi-ethnic community. This choice of timeframe was made to guarantee the most recent pattern of variables related to governance and development in a multi-ethnic community. The articles that are indexed in the social sciences and sciences stream articles are then included to provide a broader perspective on the topic.

Table 26: Eligibility and Exclusion criteria

Criteria	Inclusion	Exclusion
Document Type	Articles journal	Review articles, book series, books, Chapter in a book, conference proceeding
Language	English	Non-English
Publication Timeline	2017 - 2022	<2017

Thematic review process

Identification is the initial phase. The search process's keyword is determined at this level. Thesaurus and previous research as well as the literature review were utilized to determine similar and relevant terms for the governance and multi-ethnic word, as shown in Table 2 below.

Table 27: Search string

DATABASE	SEARCH STRING
SCOPUS	TITLE-ABS-KEY (governance AND multi-ethnic*) AND (LIMIT-TO (PUBYEAR, 2022) OR LIMIT-TO (PUBYEAR, 2021) OR LIMIT-TO (PUBYEAR, 2020) OR LIMIT-TO (PUBYEAR, 2019) OR LIMIT-TO (PUBYEAR, 2018) OR LIMIT-TO (PUBYEAR, 2017)) AND (LIMIT-TO (DOCTYPE, "ar")) AND (LIMIT-TO (LANGUAGE, "English"))

The selection of the type of literature, language, and year of publishing led to the removal of 58 studies (out of 80) during the screening procedure at the second level. The final stage of eligibility involves a review of the entire article. A total of 12 papers were eliminated after a thorough review because they lacked the elements associated with managing governance in a multi-ethnic community, did not include empirical data, or did not have a governance key

element in a multi-ethnic society focus. Finally, 10 publications in all were used for the review's outcomes and qualitative analysis.

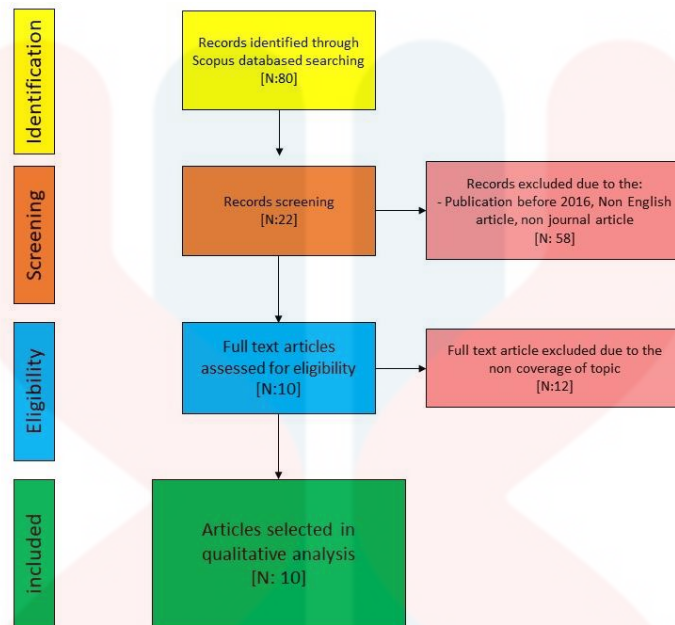

Figure 2: PRISMA model process

Data abstraction and analysis

10 articles in total were looked over and thoroughly analyzed. Studies that addressed the review's research question were the primary focus of the analysis. The conclusion was reached by first reading the abstract, followed by a thorough study of the entire article to identify the main subject and any related subthemes of the article's discussion of governance and development in multi-ethnic community-related elements. Next, the qualitative research procedure used content analysis to pinpoint the theme of elements tied to governance and development in a multi-ethnic community.

RESULT

The review identified 15 governance and development elements in a multi-ethnic community in the six years latest study. The elements are legislation, politic, association, space planning, decentralization, institution, education, engagement, resource and distribution, security, community capacity, nation-building, basic need, demography, and religion management. The article collection for review in this paper was published between 2017 and 2022. Two papers were published in 2022 and 2021, one paper was published in 2019, followed by three papers published in 2018 and one paper in 2017. As for the methodology approach, seven studies were carried out by qualitative approach, two studies followed the quantitative approach, and only one study was carried out in a mixed method.

In the last six years, the study about governance and development that focus on the multi-ethnic community in SCOPUS databased were observed in European countries like Italy and Kosovo, Middle East countries like Egypt and Saudi Arabia, and Asia regions such as Pakistan and China. Table 3 shows the findings of the elements that have been used by previous studies in the governance management and development of various ethnic communities around

the world for the past six years. Engagement and political elements are the most frequently used and paid attention to in the management of various ethnic communities. While elements such as religious management, public legislation, space planning, education, security, community capacity, and nation-building are elements that have received the least attention in the last six years in the study of governance and development of various ethnic communities.

Table 28: Thematic review

Author	F. Che et al	Khan & Arshad	Vidovich & Bovo	Paris and Ying	Veenendaal	Ferati-Sachsenmaier	Cayli	Paul	Cole	Calu
Year	2022	2022	2021	2021	2020	2019	2018	2018	2018	2017
Country	China	Pakistan	Italy	Italy	South America	Kosovo	Egypt	Europe	Saudi Arabia	Kosovo
1. Legislation										
2. Politic										
3. Association										
4. Space planning										
5. Decentralization										
6. Institution										
7. Education										
8. Engagement										
9. Resource and distribution										
10. Security										
11. Community capacity										
12. Nation building										
13. Basic need										
14. Demography										
15. Religion management										

DISCUSSION

This writing is a thematic review of the findings of studies related to governance and development in multi-ethnic communities around the world in the last six years. This study has analyzed the findings from 10 studies that have empirical data. A total of 15 main elements have been identified as elements focused on the governance and development of multi-ethnic communities.

Based on the thematic review that has been conducted, the element of engagement is the element that is given the highest attention in managing a diverse community. Among the things that contribute to the element of engagement in multi-ethnic communities are social relationships whether physical or virtual, neighborhood relationships, participation in the community, relationships whether at the individual, community, or institutional level as well as dissemination of information in the community.

The importance of social relationships in the community is certainly recognized, especially in multi-ethnic communities. Social relationships are a focal point in human life that play an important role in terms of human life (Olsson, 2011). Close relationships among people are the basis of dependence and also human social support (Berkman et al., 2003). Social relationships are also a source of social influence, the basis for the formation of identity, and a sense of belonging and create social comparison (Berkman et al., 2003). In addition, social relationships also allow us to access resources (Lin, 2001). Apart from that, social relationships are also an important tool to build unity and a progressive society (Butler, 2019). To ensure the success and development of a country, it is important to ensure that social relations in society are in good and close condition despite living in diversity and differences (Lee, 2018).

Positive social relationships in a multi-ethnic society are seen to be able to reduce prejudice (Molina & Wittig, 2006), increase the sense of shared identity (Nier et al., 2001), and increase intimacy between individuals of various ethnicities. In fact (Pettigrew & Tropp, 2006) when an individual has a good social relationship with an individual of different ethnicity, for example as a friend, that individual will also be able to reduce prejudice against the ethnic group of his friend. This shows that positive social relationships not only benefit two individuals of different ethnicities but also influence the perception of individuals with other ethnic groups as a whole.

Next, the political element is also the highest element given the focus on its role in the management of multi-ethnic communities. The relationship between governance, development, and political stability is very important in the management of member relationships in multi-ethnic communities (Kuper, 1974). Political party stability, healthy political party relations, political power-sharing, and the role of committed politicians are the basis of the political environment required in a multi-ethnic community. Horizontal political relations will also open up space for freedom of expression in the community, social movement, access to information, and increased participation in the community. Stable political values such as integrity, fairness, accountability, transparency, and inclusiveness can sidestep critical issues in society such as corruption, misuse of power, and oppression of certain groups that can trigger misunderstandings and mobilization of ethnic group sensitivity issues to obtain rights and justice if not managed well (Othman & Zain, 2020).

The formation of a plural country requires the support of every community group toward its government. Therefore, support from every citizen needs to be obtained through political parties. Political power sharing is one of the efforts that can be implemented by political parties to get the support of different groups in a multi-ethnic society. Partnership or cooperation with political parties can occur in the form of shared values of togetherness between political parties with different ideologies and finally form an agreement for mutual benefit (Othman & Zain, 2020). Among the common values that can be a factor in the cooperation of different political parties are the values of justice, decency, the integrity of the constitution, and the rule of law. These partnerships can not only stabilize the political atmosphere in a country but can also be a cornerstone for sharing power for the sake of justice and community welfare.

Apart from the role of political stability through the cooperation of political parties, the role of decentralization is also seen as important in managing communities of various ethnicities. Decentralization is the distribution of administrative implementation from the center to other authorities or groups to improve the efficiency and effectiveness of services. Decentralization is said to be able to form a democratic and stable multi-ethnic society. However, power sharing and decentralization in a country have been linked to the total population and geographic size of a country. Power sharing is understood to be possible in small regions such as regions within European countries and small cities in South America. However, the implementation of the decentralization framework has failed to be applied in countries with a large plurality such as Iraq, Afghanistan, Burundi, and Lebanon (Veenendaal, 2020).

Next, the role of government institutions cannot be denied in their importance in managing communities of various ethnicities. The role of institutions is seen to have an impact on the entire level of community management starting from basic needs, resource distribution, education, infrastructure, security, and legislation up to nation-building. Transparent public

services, integrity, and inclusion in providing these needs are the backbone of building a competitive and stable community. Modernization theory (Martinelli, 2005) also explains human development through the provision of basic needs as well as survival needs and a quality environment as the starting point for the progress of a country.

The management of growth and fair and equitable distribution, as well as the management of social inequality in society, will revive a more mature democratic atmosphere, increase security, develop the community's economy through entrepreneurial enterprises, reduce violent conflicts and build a more stable and united country. The culture of modern society and comprehensive community development will increase the horizontal relationship of various ethnic communities, indirectly increasing the cohesion and togetherness in the community.

CONCLUSION

This study has identified important elements in the management of governance and development in communities of various ethnicities by using the thematic review method of the latest six-year study. This article has been able to identify 15 important elements which are legislation, politics, association, space planning, decentralization, institution, education, engagement, resource and distribution, security, community capacity, nation-building, basic need, demography, and religion management.

Governance and development in communities of various ethnicities are closely related to the comprehensive development of each member of the community. Every member and group in the community cannot be left out of the flow of national development. Groups that lag behind the trend of development will tend to be radical towards government institutions and the surrounding community. The social protests that occur will affect cross-ethnic relations and use the ethnic dimension to face the challenge of survival.

The findings of this study have been able to provide an initial reference to the researcher on the elements that need to be given attention in managing governance and development in a multi-ethnic society. However, this article only identifies studies found in the SCOPUS database from 2017 to 2022. Further studies are suggested to also look at articles found in other databases.

ACKNOWLEDGEMENT

This research was supported by the Ministry of Higher Education (MOHE) through Fundamental Research Grant Scheme (FRGS/1/2021/SS0/UTHM/02/2) and Universiti Tun Hussein Onn Malaysia through REGG (vot H882).

REFERENCES

- Apter, M. J. (1984). Reversal theory and personality: A review. *Journal of Research in personality*, 18(3), 265-288.
- Berkman, L. F., Glass, T., Brissette, I., & Seeman, T. E. (2000). From social integration to health: Durkheim in the new millennium. *Social Science & Medicine*, 51(6), 843–857. [https://doi.org/10.1016/S0277-9536\(00\)00065-4](https://doi.org/10.1016/S0277-9536(00)00065-4)

- Butler, R. (2019). Young people's rural multicultures: researching social relationships among youth in rural contexts. *Journal of Youth Studies*, 0(0), 1–17. <https://doi.org/10.1080/13676261.2019.1657564>
- Calu, M. I. (2018). Unintended consequences of state-building and the management of diversity in post-conflict Kosovo. *Nationalities papers*, 46(1), 86-104.
- Cayli, B. (2020). Crime, bandits, and community: how public panic shaped the social control of territory in the Ottoman Empire. *Territory, Politics, Governance*, 8(3), 356-371.
- Che, F., Zhou, Y., & Liu, Y. (2022). Social quality, knowledge hiding, and community capacity: a study on multi-ethnic communities in Chinese cities. *Journal of Business Research*, 144, 1024-1038.
- Cole, J. (2018). Caliphates and Juntas: Ottoman Legacies in Today's Controversies over Religion and State in the Arab World. *Social Science History*, 42(4), 797-810.
- DeDominicis, B. E. (2019). Indo-Pacific Grand Strategy: Power Politics and Sustainable Development. *International Journal of Climate Change: Impacts & Responses*, 11(2).
- Elahi, K. Q. I. (2009). UNDP on good governance. *International Journal of Social Economics*.
- Evers, H. D., Purwaningrum, F., Lim, S. A., & Ndah, A. B. (2014). Tadbir Urus Pengetahuan: Sudut Pandang dari Brunei Darussalam dan Malaysia. *Akademika*, 84(1&2), 29-43.
- Ferati-Sachsenmaier, F. (2019). Postwar Kosovo: Global and local dimensions of interethnic reconciliation processes. *International Journal of Transitional Justice*, 13(2), 310-327.
- Grishaeva, E. B. (2012). Multiculturalism as a Central Concept of Multiethnic and Polycultural Society Studies; *Journal of Siberian Federal University. Humanities & Social Sciences*
- Jenkins, K., Jenkins, K., & Plowden, W. (2008). *Governance and nationbuilding: The failure of international intervention*. Edward Elgar Publishing.
- Khan, H. F., & Arshad, S. A. (2022). Beyond water scarcity: Water (in) security and social justice in Karachi. *Journal of Hydrology: Regional Studies*, 42, 101140.
- Kuper, L. (1974). On Theories of Race Relations. *Ethnicity and Nation-Building: Comparative, International, Historical Perspectives*. Beverly Hills: Sage.
- Lee, C. C. (Ed.). (2018). *Counseling for social justice*. John Wiley & Sons.
- Lin, N. (2017). Building a network theory of social capital. In *Social capital* (pp. 3-28). Routledge.
- Lorenzo De Vidovich & Martina Bovo (2021): Post-suburban arrival spaces and the frame of 'welfare offloading': notes from an Italian suburban neighborhood, *Urban Research & Practice*, DOI: 10.1080/17535069.2021.1952482
- Mario Paris & Fang Ying (2021) Toward a new normality in Via Paolo Sarpi (Milan, Italy)? Social behaviors and spatial transitions during and after the lockdown, *Journal of Human Behavior in the Social Environment*, 31:1-4, 305-324, DOI:10.1080/10911359.2020.1823295
- Martinelli, A. (2005). *Global Modernization: Rethinking the project of modernity*. Sage.
- Molina, L. E., & Wittig, M. A. (2006). Relative importance of contact conditions in explaining prejudice reduction in a classroom context: Separate and equal?. *Journal of Social Issues*, 62(3), 489-509.
- Nier, J. A., Gaertner, S. L., Dovidio, J. F., Banker, B. S., Ward, C. M., & Rust, M. C. (2001). Changing interracial evaluations and behavior: The effects of a common group identity. *Group Processes & Intergroup Relations*, 4(4), 299-316.

- Olsson, E. (2011). Social relations in youth: determinants and consequences of relations to parents, teachers, and peers (Doctoral dissertation, The Swedish Institute for Social Research (SOFI), Stockholm University).
- Paul, S. (2018). Clash of claims: nationalizing and democratizing policies during the first parliamentary election in multiethnic Czechoslovak Ruthenia. *Nationalities Papers*, 46(5), 776-790.
- Pettigrew, T. F., & Tropp, L. R. (2006). A meta-analytic test of intergroup contact theory. *Journal of personality and social psychology*, 90(5), 751.
- Triranjana Raj. (2010). Redefining Good Governance in Culturally Plural Societies; *The Indian Journal of Political Science*, Vol. 71, No. 3 pp. 713-730
- Veenendaal, W. (2020) Does Smallness Enhance Power- Sharing? Explaining Suriname's Multiethnic Democracy, *Ethnopolitics*, 19:1, 64- 84, DOI:10.1080/17449057.2019.1590078



Performance Study of Virtualized Firewalls in Small Office Home Office Environment

Muhammad Iqhwana Bin Adnan
Universiti Teknikal Malaysia Melaka
b031910287@student.utm.edu.my

Khadijah Wan Mohd Ghazali
Universiti Teknikal Malaysia Melaka
khadijah@utm.edu.my

Nurul Azma Zakaria
Universiti Teknikal Malaysia Melaka
azma@utm.edu.my

ABSTRACT

Firewall is an essential tool used to secure the network of an organization. However, implementing security tools such as firewalls impacts the network performance. Small Office Home Office (SOHO) business organizations need recommendation of a firewall that is low-cost yet able to maintain the network performance. The purpose of this research is to compare three virtualized firewalls that are used in SOHO environment through performance tests. For this study, a simulation is set up in a virtual environment. It consists of a virtual SOHO network where three virtualized firewalls are installed. The three firewalls are pfSense, Smoothwall and Endian Firewall. For each firewall, traffics are generated and tested while running the firewalls in two scenarios: normal scenario and attack scenario. The normal scenario is taken as baseline, whereas the attack scenario is created by launching a TCP SYN Flood attack to the network. In both situations, performance is measured based on the throughput of TCP traffic and file transferring traffic. An analysis is carried out to determine which firewall gives the least impact on the network performance. The result shows that Endian Firewall gets the least performance degradation, hence recommended as the firewall that gives the best performance in the SOHO environment. The value is obtained by averaging the value obtained from fifteen iterations of each set of test. For future works, this research can be extended by comparing the firewalls in another aspect such as their capabilities of securing the network under various attacks.

Keywords: *Virtualized firewall; performance comparison; TCP SYN attack; SOHO network.*

INTRODUCTION

With the advent of internet usage, network security has become necessary to protect the usability and integrity of networks and data in worldwide (Al-Qasim & Al-Hemiary, 2018). Nowadays, it is necessary to select and deploy a firewall. A firewall is a network device that operates at the intersection of two separate computer networks, usually internal and external. Firewalls are a mandatory part of the computer networking in businesses, offices, and other organizations. Choosing the proper security device is very important because it affects all the traffic passing between the local and external networks. Many solutions are available to protect the IT system, one of them is by integrating a firewall (Hussain, 2018, Koivunen, 2018 and Sangfor Technologies, 2021.).

Firewall deployment is a costly endeavor especially when dedicated or hardware firewalls are used. Hence, small organizations like SOHO (Small Office Home Office) need a

more cost-effective alternative (Gupta, 2022, Louis et al., 2021 and Tkachov, 2019). Virtualized firewalls offer a cost-effective yet powerful solution where software firewalls are implemented in virtual network environments (Alaluna et al., 2019, Al-Qassim and Al-Hemiary, 2018, Azzam et al., 2019, Bernardos et al., 2019 and Mihalos et al., 2019)

In this research, three types of open-source firewalls have been listed to find out the throughput measurement and performance testing for a particular application: Pfsense, Smoothwall and Endian firewall. These firewalls are recommended in many recent researches (Arunwan et al., 2016, Azzam et al., 2019, Koivunen, 2018, Othman, 2017 and Sangfor Technologies, 2021). Performance testing of firewalls can be carried out to determine which firewalls perform better in a given scenario (Koivunen, 2018 and Melkov, 2020). The analysis is based on experiments in a prepared network environment and the same scenario.

The main purpose of this project is to determine the significant influence of factors towards the unsecured network, to analyse the performance of a firewall in protecting Small Office Home Office (SOHO) networks and examine the effectiveness of virtualization technology in protecting the network. This project implementation can be the source of reason for others researcher in determining factors towards an unsecured network and produce a report of measurement data in throughput measurement and performance testing and encourage people to apply open-sources firewall in the network environment.

METHOD

In this section, the design of the testing method and scenario are explained. It also focuses on the technique used to complete this research project. In this research, each sample of open-source firewall will be evaluated to their throughput measurement and performance testing. Throughput testing is a key concept for good performance testers to understand and is one of the methods used to measure how well a firewall is performing in terms of link quality. Performance testing is a method that can indicate the performance of network quality in handling the file transfer with normal and attack condition (Azzam et al., 2019).

The hardware that was used consists of a physical computer. The physical computer used is Dell OptiPlex 9020. The computer consists of processor Intel(R) Core (TM) i7-4790 CPU @ 3.60GHz, Memory of 32 GB RAM DDR3 and 1TB hard disk. The physical computer was used to run the VMware workstation that consisted of all types of firewalls, windows 10 as a client, Linux Mint as an FTP server and Kali Linux as an attacker. Virtual network is built by configuring each host with three network adapters which are VMNET 0 as a bridge adapter (LAN), VMNET 1 as a Host-Only adapter (DMZ) and VMNET 8 as a NAT adapter (WAN). The client and server site have been configured with VMNET 0 as a bridge adapter (LAN). In addition, the FTP server IP address has been configured with a static IP, and the client user received the IP address from firewall DHCP.

As shown in Fig.1, the throughput testing topology consisted of one client and a server. Throughput testing was performed in this study using iperf3. This tool can measure throughput by forwarding TCP traffic from a computer client to an FTP server. It was used to determine the throughput performance of the firewall's ability to differentiate between normal and TCP SYN attack conditions.

Figure 3. Throughput testing topology.

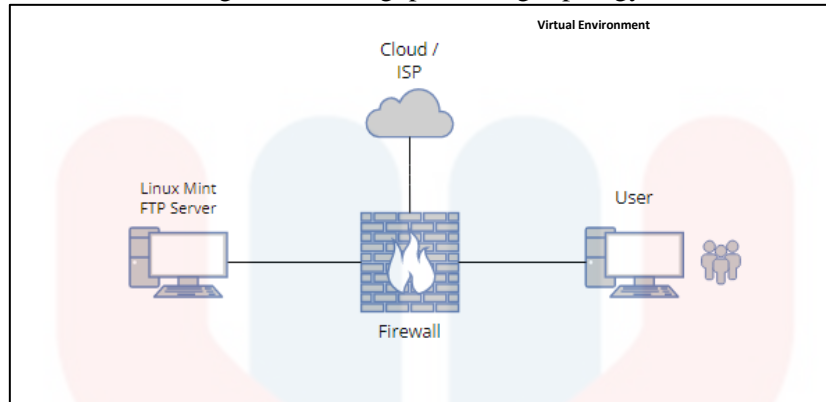

The second topology as it is shown in Figure 2, the topology was used for testing firewall's performance. It was conducted by running file transfer using FTP protocol in a normal condition and under TCP SYN attack. By using the test result, two firewalls' performance was compared to see which firewall performed best in normal and under attack condition. The performance of the firewall was evaluated by measuring the average bandwidth produced by each of firewall.

Figure 4. Performance testing topology.

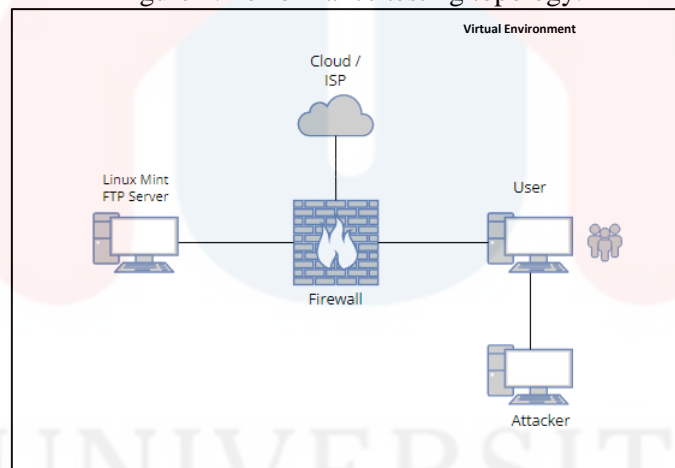

Throughput testing

These testing scenarios were conducted using iperf3 as a TCP traffic packets generator from a client computer to an FTP server in normal and attack conditions. The purpose of measuring throughput is to determine which pfSense, Smoothwall, and Endian firewalls show the least performance degradation. The smaller degradation value shown a better performance.

Performance testing

Performance testing was done by measuring the performance degradation of FTP (File Transfer Protocol) service. The testing was accomplished by emulating the bandwidth on the VM Linux Mint FTP server using a 1 GB file between one client laptop that utilized as an FTP client. Two circumstances were constructed for testing, the normal situation without TCP SYN Flooding attack and the attack condition. Iperf3 was used in this analysis to measure the network quality of the firewall.

RESULT

This section presents the research outcomes, which include throughput testing and performance testing.

Throughput testing

In this test, the results of normal and attack condition throughput testing between three open-sources firewalls will be displayed. The purpose of testing with normal condition in this study is to see the value of average throughput between FTP server with the client and compare the result on attack condition between server and client.

The output of throughput testing of each firewall on normal and under attack data respectively were formed into a graph which can be seen in the following Figure 3 and Figure 4.

Figure 5. Firewall throughput testing in normal condition.

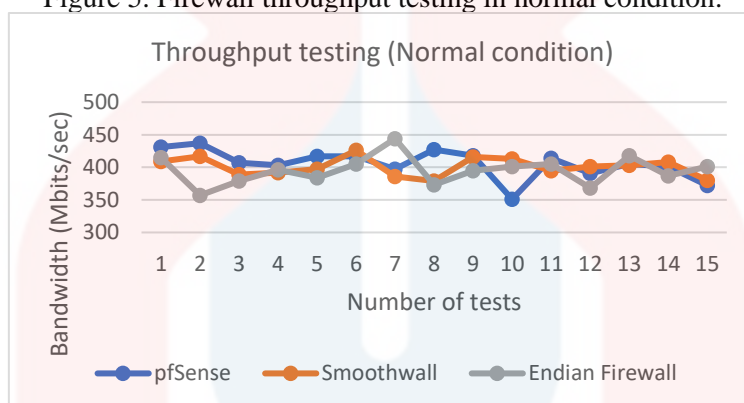

Figure 6. Firewall throughput testing in attack condition.

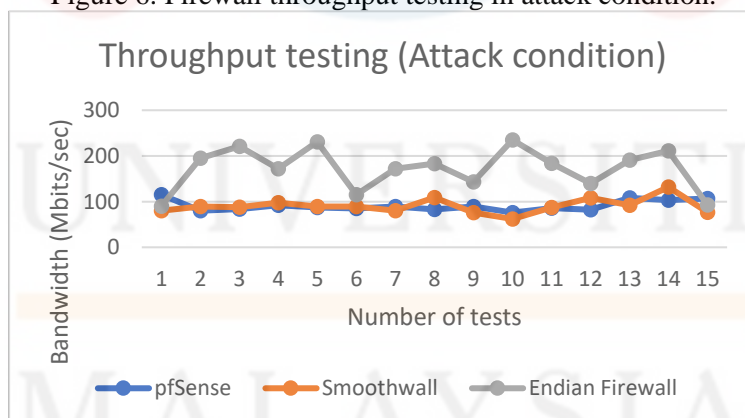

Table1 exhibits performance degradation that takes place at each firewall when under attack as compared to the normal condition.

Table 29. Throughput testing result.

Performance Testing			
Firewall	Pfsense	Smoothwall	Endian Firewall
Normal Condition (Mbits/s)	439	384	392
Attack Condition (Mbits/s)	111	119	127
Performance degradation (%)	75 %	69 %	68 %

Performance testing

In the performance testing, the results of normal and attack condition between three open-sources firewalls will be displayed during handling the 1 GB file transfer from server to client. It can be seen on the Figure 5 Figure 6 and Table 2ee

The output of throughput testing of each firewall on normal and under attack data respectively were formed into a graph which can be seen in the following Figure 5 and Figure 6.

Figure 7. Firewall performance testing in normal condition.

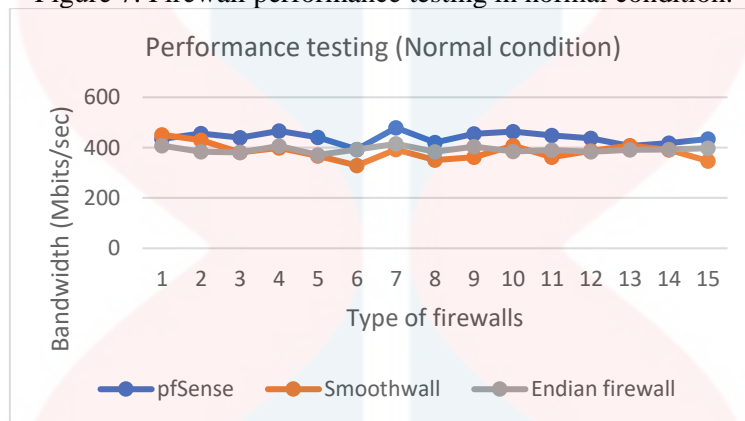

Figure 8. Firewall performance testing in attack condition.

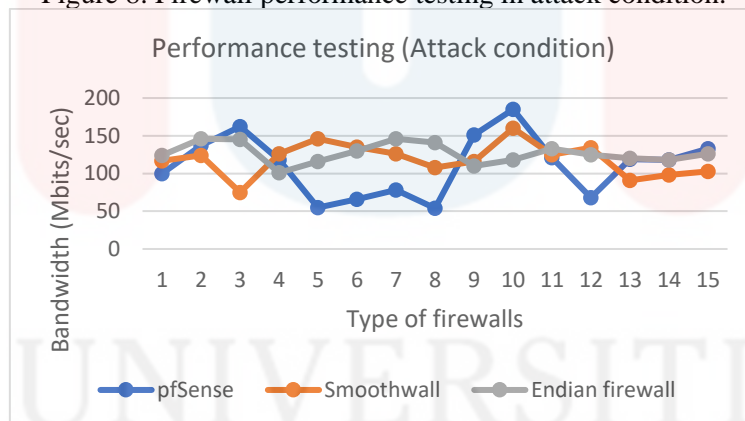

Table2 exhibits performance degradation that takes place at each firewall when under attack as compared to the normal condition.

Table 30. Performance testing result.

Throughput Measurement			
Firewall	Pfsense	Smoothwall	Endian Firewall
Normal Condition (Mbits/sec)	406	401	395
Attack Condition (Mbits/sec)	91	90	172
Performance degradation (%)	78 %	78 %	56 %

ANALYSIS AND DISCUSSION

This research was conducted on virtual network environment by using VMware to indicate throughput testing on pfsense, Smoothwall and Endian firewall. By using pfsense a throughput value of 406 Mbits/s in normal condition. However, throughput value decreased to 91 Mbits/s

after having a SYN flood attack on the client machines with performance degradation 78 %. Using Smoothwall, a throughput of 401 Mbits/s was achieved in normal condition. After a SYN flood attack on the client machines, the throughput output dropped to 90 Mbits/s with 78% decrease in performance. Utilizing Endian Firewall, a throughput value of 395 Mbits/s was attained in normal condition. However, after a SYN flood attack on the client machines, throughput reduced to 172 Mbits/s with 56% performance decrease.

The performance degradation was caused by the client machines had been directly exposed to the SYN flood attack. It led to a decrease in machines resource system usage which resulted throughput's reduction.

By comparing all performance degradation value, Endian firewall shows the best performance with minimum percentage of performance degradation value of 56% compared with pfSense, and Smoothwall. Meanwhile, pfSense and Smoothwall has similar value of performance degradation which is 78% to from the result of under attack and normal condition.

Based on the comprehensive performance testing using FTP services, Endian firewall has the best performance with more excellent value. As a result, the faster speed causes a shorter time, which means that the lower the value obtained, the better the performance. When each firewall is faced with an SYN flood attack, it causes performance degradation, as seen in the table below. In addition, the pfSense firewall has a higher performance reduction of 75%, followed by the Smoothwall firewall with a 69% performance reduction compared to the Endian firewall, which only has a performance decrease of 68% for performance testing.

CONCLUSION

In reviewing the firewalls, an important note was made concerning their throughput measurement and how the software was utilized to manage the network connection. The comparison of pfSense, Smoothwall, and Endian firewall revealed that the Endian firewall could handle the situation in throughput testing. The main thing that gave Endian firewall a recommendation for the best performance firewall was achieving average bandwidth output in the normal and attack condition with performance degradation of 56%. It seemed that the Endian firewall was more efficient in utilizing the network link quality with a low-performance degradation compared to pfSense and Smoothwall with minimum performance degradation on 68%. This conclusion was based on observing a specific scenario's throughput and performance testing. During the tests on Endian firewall, the software managed the network in any situation with a stable connection and without decreasing the link quality.

Based on this analysis, it is concluded that overall Endian firewall has the best performance especially under Syn flood attack. It means that Endian firewall has a better ability to manage the Small Office Home Office (SOHO) network in any conditions.

REFERENCES

- Alaluna, M., Vial, E., Neves, N., & Ramos, F. M. V. (2019). Secure multi-cloud network virtualization. *Computer networks*, 161, 45–60.
- Al-Qassim, M. A., & Al-Hemiary, E. H. (2018). Network perimeter defenses using open-source software. *Iraqi Journal of Information and Communications Technology*, 1(2), 41-51.

- Arunwan, M., Laong, T., & Atthayuwat, K. (2016). Defensive performance comparison of firewall systems. In *2016 Management and Innovation Technology International Conference (MITicon)* (pp. MIT-221). IEEE.
- Azzam, A. T., Munadi, R., & Mayasari, R. (2019). Performance analysis of firewall as virtualized network function on VMware ESXI hypervisor. *Jurnal Infotel*, 11(1), 29-35.
- Bernardos, C. J., Rahman, A., Zuniga, J. C., Contreras, L. M., Aranda, P., & Lynch, P. (2019). *Network virtualization research challenges* (No. rfc8568)
- Gupta, M., Kumar, R., Ahmed, S., Priyadarshan, P., & Sharma, A. (2022). Low latency packet delivery for SOHO infrastructure. In *2022 2nd International Conference on Computing and Information Technology (ICCIIT)* (pp. 65-68). IEEE.
- Hussain, A. (2018). Use of firewall and ids to detect and prevent network attacks. *International Journal of Technical Research & Science*, 3(IX), 289–292.
- Koivunen, J. (2018). *Installing and testing open source security appliances*. (Unpublished bachelor dissertation). Metropolia University of Applied Science.
- Louis, F., Duskarnaen, M. F., & Ajie, H. (2021). Uji kecepatan raspberry pi sebagai private cloud storage untuk small office home office: dengan studi kasus di UPT TIK. *PINTER: Jurnal Pendidikan Teknik Informatika dan Komputer*, 5(2), 42-49.
- Melkov, D., Šaltis, A., & Paulikas, Š. (2020). Performance testing of Linux firewalls. In *2020 IEEE Open Conference of Electrical, Electronic and Information Sciences (eStream)* (pp. 1-4). IEEE.
- Mihalos, M. G., Nalmpantis, S. I., & Ovaliadis, K. (2019). Design and implementation of firewall security policies using Linux iptables. *Journal of Engineering Science & Technology Review*, 12(1).
- Othman, R. B. (2017). *Network monitoring using captive portal in pfSense*. (Unpublished bachelor dissertation). Universiti Sultan Zainal Abidin.
- Tkachov, V., Hunko, M., & Volotka, V. (2019). Scenarios for implementation of nested virtualization technology in task of improving cloud firewall fault tolerance. In *2019 IEEE International Scientific-Practical Conference Problems of Infocommunications, Science and Technology (PIC S&T)* (pp. 759-763). IEEE.

Muhyiddin Yassin's Effective Public Speaking Style and Its Effect on Leadership Brand

Azman Bidin

Universiti Malaysia Kelantan
azman.bidin@umk.edu.my

Azran Fitri

Universiti Malaysia Kelantan
azran.fitri@gmail.com

Ali Salman

Universiti Malaysia Kelantan
ali.salman@umk.edu.my

ABSTRAK

Pengucapan Awam yang Berkesan mungkin merupakan salah satu alat pemasaran terbaik yang akan meningkatkan jenama kepimpinan seseorang dengan serta-merta. Tidak ramai penyelidik komunikasi korporat telah mengkaji kesan pengucapan awam yang berkesan terhadap jenama kepimpinan. Oleh itu, jurang kajian ini memerlukan kajian untuk meneroka kesan dimensi EPS terhadap pembinaan jenama kepimpinan dalam konteks pemimpin politik sesebuah negara, perdana menteri, khususnya. Kajian ini memperhalusi empat ucapan khas daripada 100 hari pertama beliau memegang jawatan dan semasa 100 hari terakhir memegang jawatan perdana menteri. Di samping itu, kajian itu juga termasuk sesi temu bual dengan seorang wartawan yang mengikuti ucapan Muhyiddin Yassin semasa beliau berkhidmat. Analisis tematik digunakan untuk menganalisis ucapan teks dan sesi temu bual. Dimensi pengucapan awam (EPS) berkesan oleh Muhyiddin Yassin tidak menjejaskan jenama kepimpinannya. Dapatan kajian ini boleh dijadikan sebagai alat untuk semua pemimpin dalam keluarga, perniagaan dan kerajaan tentang cara menyampaikan pengucapan awam yang berkesan dengan mengambil kira elemen Logos, Ethos, dan Pathos.

Kata kunci: Pengucapan Awam; Jenama Kepimpinan; Komunikasi Korporat; Analisis Tematik

ABSTRACT

Effective Public Speaking is probably one of the best marketing tools which would instantly increase one's leadership brand. Not many corporate communication researchers have begun to examine the effect of effective public speaking on leadership brands. Therefore, this research gap warrants a study to explore the effect of the dimensions of EPS on building leadership brands in the context of a country's political leader, the prime minister, in particular. This study deals with four special addresses from his first 100 days in office and during the last 100 days of his premiership. In addition, the study also included an interview session with a journalist who had been following Muhyiddin Yassin's speeches during his tenure. Thematic analysis was applied to analyse the textual speeches and the interview session. The dimensions of effective public speaking (EPS) by Muhyiddin Yassin do not affect his leadership brand. The findings of this study can be served as a tool for all the leaders in families, businesses, and the government on how to deliver effective public speaking by considering the elements of Logos, Ethos, and Pathos.

Keywords: Public Speaking; Leadership Brand; Corporate Communication; Thematic Analysis.

INTRODUCTION

Public speaking is defined as communication to a larger group of audience with a definite objective of influencing, persuading, apprising, stimulating, or amusing them (Mehta, 2018). It evolved long before the age of amplification. To address a crowd of any size, speakers would have to slow down, breathe deep, and let rip, with dramatic pauses after each sentence. It's a style of speaking we recognise today as oration. It's a speaking style that can sync up crowd emotions and responses in a powerful way (Anderson, 2016). There comes a time in every leader's career when public speaking is more than a "nice to have" skill. It's essential. For some, this moment comes early in their careers, for others, a little later. They reach a point when they must become masterful at communicating with all of their important audiences (Bates, 2007). Thus, effective public speaking (EPS) is a critical factor in becoming a more efficient and successful leader. Many researchers define a leader as someone who can take charge, direct, encourage, or stimulate others (Roos, 2013). EPS acts as an important factor to grow as an efficient and successful leader or manager. Effective public speaking is the most important key to great leadership (Luthra & Dahiya, 2015).

Ideally, leadership is best described by those who are directly involved in the entire process of completing specific tasks that have been set out by individuals on behalf of the institution or organisations (Nasrudin, 2005). Also, leadership is all about relationships, which are leader-follower relations in a specific setting, and under various situations. It is an abstract term. In other words, leadership is a process, not a personality (Nasrudin, 2005; Wyne, 2017). According to many researchers (Barrett, Deborah, 2006; Frese et al., 2003; Jaes et al., 2021; Luthra & Dahiya, 2015; Nasrudin, 2005; Rais, 2021), a leader can take charge, direct, encourage, or stimulate others. They have the desire to persuade others and persuade them to follow the goals or principles that they have defined. They are results-oriented, so they are well-trained and experts in controlling difficult to difficult conditions, and they help to improve the outputs of teams that work with them (Luthra & Dahiya, 2015). To be a great leader, one must be an excellent communicator. Great leaders are always thought to be first-class communicators, to have a clear set of values, and to believe in promoting and instilling those values in others. Because of this, their teams respect and look up to them as a leader. Leaders who communicate effectively to encourage and stimulate their followers are regarded as the best leaders or managers (Luthra & Dahiya, 2015).

A leader could be anyone, as the person who has charge taking attitude is a leader. He could be a prime minister of any nation or an executive working in an organization. These people have a cluster of leadership qualities but are not able to lead if they are not good communicators. Communication enables them to share what they have and what they expect from others. So, it is effective public speaking, which makes leaders lead successfully (Barrett, Deborah, 2006; Frese et al., 2003; Luthra & Dahiya, 2015).

In this study, a leader refers to the prime minister in particular. A prime minister is the leader of the whole nation. The strength of a prime minister doesn't always mean power, but also intention. The intention oneself for the betterment of the people in this country, be it how painful or what needs to be sacrificed (Rais, 2021). In general, there are many roles expected of him. At all times, he is expected to guide the people by setting himself as the role model. Is he a man of his word especially when it comes to realising the party's election manifesto? Is he able to initiate the necessary drive for the people to help him achieve what he wants for the good of the country? Does he have the ability to balance that delicate matters concerning issues that are deemed to be seen as highly sensitive in a multi-ethnic society like Malaysia? Thus,

not only he must have the ability to gain acceptance and support from his cabinet ministers and party members, but he must also be able to show his willingness to serve his followers and the entire people. He could display his leadership style either by saying it out clearly to the people, for example, that he is a servant leader, or simply by displaying some sort of leadership process by showing his cabinet ministers ways of doing things (Nasrudin, 2005).

To do so, besides having certain skills such as the ability to communicate and convince the people, especially the cabinet ministers, he must also have goals or missions that are visible and easily understood through his words and actions. As an example, making the objectives and missions clear and known to the people can be done effectively by consistent ‘selling’, ‘telling’, and ‘persuading’ the people about philosophies and principles that are close to their hearts, such as ‘clean, efficient & trustworthy’ and ‘transparency & integrity’ (Nasrudin, 2005).

EFFECTIVE PUBLIC SPEAKING

Public speaking entails communicating with the audience rather than with it. It does not refer to a one-way broadcast of information, but rather to a conversation between the speaker and the audience (Baccarani & Bonfanti, 2015). In many professions, public speaking often plays an important role in helping to achieve business objectives. This becomes significantly likelier when speakers manage to effectively inform, influence, or persuade their audience (Mehta, 2018).

As a result, effective public speaking (EPS) is an important factor in becoming a more efficient and successful leader. A leader, according to many researchers, is someone who can take charge, direct, encourage, or stimulate others (Roos, 2013). EPS is the most effective marketing tool for instantly increasing one's brand (Vasudevan, 2019). It acts as an important factor to grow as an efficient and successful leader or manager. It is an important factor in developing an effective and successful leader or manager. The most important key to great leadership is effective public speaking (Luthra & Dahiya, 2015).

Dimensions Of Effective Public Speaking (Eps) In Textual Speech

The foundation of effective public speaking is strong arguments (logos) presented in a credible (ethos) and exciting (pathos) manner (EPS) (Baccarani & Bonfanti, 2015). Public speakers must combine logic skills (public speaking as science) with an "out-of-the-box" approach (public speaking as art) to deliver an interesting, appealing, and engaging presentation (the antecedents of EPS). EPS has a positive impact on an organization's human resources professional growth, trust in corporate leadership, the corporate-change process, human resource motivation, and corporate reputation (Baccarani & Bonfanti, 2015).

According to Psenicka et al. (2012), EPS is a construct that is based on the speaker's abilities (dimensions) to interact with the audience by utilising both technical and personal abilities (variables) to generate interest, involvement, listening, and active participation. In other words, speakers must create and disseminate knowledge, capture and maintain their audience's attention by arousing interest and curiosity, and leave a mark in their listeners' memories. Public speakers must not only concentrate on the stages of the public speaking process but also provide strong arguments to the audience credibly and excitingly. The dimensions of EPS are logos, ethos, and pathos, which are based on ancient but timeless persuasion factors proposed in the Aristotelian philosophy of rhetoric (Baccarani & Bonfanti, 2015; Roos, 2013).

Logos: Persuading the Audience Through Strong Arguments

The logos dimension of EPS is defined as persuading the audience through strong arguments. It refers to the speaker's ability (and desire) to provide listeners with clear and logical thinking by organising the speech and establishing precisely defined goals to be met (Roos, 2013). In addition to organising ideas in an easy-to-follow format, speakers must clarify the purpose of their speech during the preparation phase, which could be to inform, teach, stimulate, persuade, actuate, sell or entertain (Baccarani & Bonfanti, 2015; Clark & Greatbatch, 2011; Daniels, 2005). They should use concrete, simple, and evocative words in their speech that anyone can understand and remember. It is also important to communicate something new: while it is implied, it is not always obvious that a speaker prepares a speech to say something new, express a particular point of view, or say something witty or provocative (Bottles, 2010), stimulates curiosity or generates new ideas in an audience by stimulating their minds and urging their brains (Baccarani & Bonfanti, 2015). To develop the logos dimension of EPS, the words of the speech must persuade the audience by presenting logical arguments based on facts and reasoning. As a result, the variables in the EPS logos dimension include the speaker's intellectual ability to ensure that the speech has clarity, logic, appropriateness, simplicity, a realistic approach, focus, rigour, and organisation (Baccarani & Bonfanti, 2015).

Ethos: Persuading the Audience Through the Speaker's Credibility

Ethos is the second dimension of EPS. The ethos dimension is related to the speaker's credibility to persuade the audience (Baccarani & Bonfanti, 2015). Even if the arguments are based on sound logic and reasoning, the audience may conclude that the speaker is untrustworthy or unworthy of their attention (Beason, 1991). Speakers must establish credibility with their audiences by persuading them to accept the speaker's arguments during the speech's opening (Baccarani & Bonfanti, 2015; Kenton, 1989). This can be accomplished by mentioning their corporate title (e.g., the position of leadership) and previous experience (e.g. mentioning past research or any awards and recognition received for their knowledge on the topic), acknowledging shared values or beliefs; or simply recognising a shared history which will reduce initial audience skepticism of the speaker (Baccarani & Bonfanti, 2015). Thus, the ethos dimension of EPS variables includes the speaker's professional ability to portray personality, authenticity, sincerity, spontaneity, awareness, trustworthiness, expertise, knowledgeable, and a position of leadership (Baccarani & Bonfanti, 2015).

Pathos: Persuading the Audience by Arousing Emotions

Pathos is another dimension of EPS that includes the speaker's ability to elicit positive emotional responses from the audience. Saying something interesting and credible is not enough; the information must be delivered in a way that captures the audience's attention and leaves an imprint in the listeners' memories. Pathos can be expressed through enthusiasm (Berkun, 2009) and passion (Sherman, 2001) while remaining natural. Speakers may both refer to values underlying the presented corporate vision to appeal to the audience's emotions while maintaining rational content and create pictures in the audience members' minds by employing visual examples and (personal) stories (Denning, 2008; Glagola, 2008; Murray, 2007; Randall & Harms, 2011), metaphors, anecdotes (Yale, 2014) or paradoxes (Roos, 2013). Using such communication devices is more compelling than simply providing general information or cold tables; as a result, these devices are more likely to ensure that the audience remembers the arguments presented in the speech. If a public speaker's presentation is dull or uninteresting, their tone of voice is flat, and their conversational style lacks rhythm, they will almost certainly

lose their audience. Something must always be changed to prevent possible speaker detachment and routine from reducing the effectiveness of public speaking. Speakers can develop pathos by persuading the audience with effective emotional appeals. The pathos dimension of EPS variables includes the speaker's ability to elicit emotions, enthusiasm, and participation from audience members; to create a sense of humour and empathy; to ensure innovation and originality; and to have storytelling and interpersonal communication skills (Baccarani & Bonfanti, 2015).

Effective Public Speaking and Leadership Brand

Effective and accurate public speaking activities act as an important factor to grow as an efficient and successful leader or manager. According to many researchers, a leader could take charge, direct, encourage, or stimulate others. They have an attitude to convince others and to make them follow the goals or the principles defined by them. They are results-oriented hence, well trained and experts in controlling difficult to difficult conditions and help to enhance the outputs of teams working with them. A leader could be anyone as the person who has charge taking attitude is a leader. He could be a prime minister of any nation or an executive working in an organization. These people have a cluster of leadership qualities but are not able to lead if they are not good communicators (Roos, 2013).

There is a strong link between public speaking and leadership brand. Leadership requires effective communication, and speaking confidently in public is a key part of that. Improving one public speaking helps in inspiring people, and boosts one's career. Leadership requires communication. A good leader can balance the seesaw of organisational politics and sway it. Leadership is about getting people to respond effectively and communication is key to that. And the ability to articulate ideas effectively in speech is a cornerstone of communication. Hence why the ancient Greeks called rhetoric “the art of winning the soul by discourse.” (Wyne, 2017). First impressions are always said to be the last impressions. Thus, there is a need to create a positive and impactful first impression with the audience when it comes to one's brand. The brand could be anything. It could be marketing a product or a service, even marketing oneself. With the power of effective public speaking skills and storytelling about one's brand, the person will be able to build a stronger more loyal audience. This could be done by controlling voice, delivering the mission, and using visuals (Anderson, 2016).

MUHYIDDIN YASSIN AND HIS LEADERSHIP

Muhyiddin Muhammad Yassin was born in Muar, Johor on May 25, 1947. He comes from a religious family and is one of the 47 children (one father, different mothers) of Muar's famous scholar, Muhammad Yassin Muhammad (Cikgu Md Yassin). He attended Sekolah Melayu Bandar Maharani and Sekolah Kebangsaan Ismail for his primary and secondary education. He then completed his secondary education at the Government English School before continuing his studies in Economics and Malay Studies at the University of Malaya (Jaes et al., 2021).

According to Tun Sheikh Engku Bendahara (2010), Muhyiddin was a diligent and hardworking student. He inherited many things from his father, but not lectures because his father was a very eloquent scholar who was well-liked by many. Muhyiddin, on the other hand, inherited the nature of humility and sharp thinking, and he was very thoughtful and content when speaking with the right arguments. Hajah Khadijah Hj Kassim is Muhyiddin's biological mother. Muhyiddin's siblings all live in their own homes with their mothers. Despite this, they

are close friends and neighbours. This large family lived affectionately and warmly together. In their neighbourhood, a private high school was established, which was well-known among Malays with low incomes at the time. This school provided assistance to those who could not afford to send their children to government or English schools. Next, according to Tun Sheikh Engku Bendahara's blog post, Muhyiddin and his siblings received the following value education:

“The surprising thing as a result of the interview with the large family (Muhyiddin) is the achievement of each individual (siblings) who have become independent, was not helped by their family or brothers and sisters anymore. This is because the foundation of teaching and education was so strong given by their father that it was almost accepted as a will. They were forbidden to take advantage and ask for family help after reaching adulthood and can be independent. They were educated to be unselfish, united, and cooperative, but they were strictly forbidden from abusing their position, corruption, greed, and persecuting people. These good values turned out to be the attitude practiced by Muhyiddin. Although he is in office and a high position, he is not biased and does not choose cronies, especially from his family members. Each had known the message of their late father and each felt ashamed to ask for the help of relatives and siblings who had succeeded. It is considered very sensitive if they intend to accumulate riches or amass wealth in a non-poverty situation. They are very aware that their father likes them to be modest people even in the situation of being the Prime Minister or a millionaire” (Tun Sheikh Engku Bendahara, 2010).

Leadership as the 8th Prime Minister of Malaysia

Muhyiddin is Malaysia's eighth Prime Minister, having been appointed on February 29th and sworn in on March 1st, 2020. It happened in a unique Malaysian political scenario when Mahathir unexpectedly resigned as the 7th Prime Minister. From then on, Muhyiddin's political destiny changed in the blink of an eye. This silent figure is seen trying to prove himself worthy of being the Prime Minister of Malaysia even though “he is not the choice of the majority of the people”. Muhyiddin strives to mobilise pragmatic actions in conjunction with effective leadership values and styles to achieve the planned mission and vision. The Yang DiPertuan Agong's mandate was boldly accepted, extraordinarily undertaken, and effectively carried out.

Muhyiddin has been criticised in several debates as a leader who is less talkative, less political, and rarely criticises his opponents. As a result, he can comfortably place himself with a high value of humility. However, in *Berita Harian*, Akbal (2020) stated that “the kick of the political world appears to be ingrained in Muhyiddin's blood, both from friends and opponents, thus becoming a tonic to stay focused on governing the country and not just playing politics.” During the first 100 days, his leadership and that of the government were regarded as brave and successful. It is especially evident when confronted with the challenges and trials of Covid-19 alongside the people. It became more well-known when his leadership during the crisis was seen to be based on local wisdom (Jaes et al., 2021).

Chronology on Premiership of Muhyiddin Yassin

Muhyiddin's resignation ends a tumultuous 17 months in office, the shortest tenure of a Malaysian leader, but it jeopardises efforts to relaunch a pandemic-ravaged economy and halt a resurgence of COVID-19 infections (Chu et al., 2021). Table 1 shows the timeline of his rise and fall as the 8th Malaysian Prime Minister.

Table 31: Chronology on Premiership of Muhyiddin Yassin

Date	Incident
Feb 29, 2020	• After meeting lawmakers, the king names Muhyiddin prime minister, assessing that he may have majority support in parliament.
March 1, 2020	• Muhyiddin is sworn in as prime minister.
May 13, 2020	• Parliament's speaker delays a confidence vote on Muhyiddin's leadership brought by Mahathir, citing a need to focus on the COVID-19 pandemic.
Oct 13, 2020	• Opposition leader Anwar Ibrahim meets the king to prove he has support to form a government. The palace says Anwar did not name lawmakers supporting him.
Oct 23-26, 2020	• Muhyiddin asks the king to declare a state of emergency to rein in the coronavirus. Anwar calls it a ploy to cling to power. The king rejects Muhyiddin's request.
Nov 26, 2020	• Muhyiddin wins parliamentary approval for his 2021 budget, seen as the first real test in parliament.
Jan 12, 2021	• The king declares a state of emergency until Aug. 1 over rising COVID-19 infections. Parliament is suspended, allowing Muhyiddin to continue unopposed. Opposition decries the move as a bid to retain control.
March 28, 2021	• A key ally, the United Malays National Organisation (UMNO), which is the biggest party in the ruling coalition, says it will not cooperate with Muhyiddin's alliance in the next election.
June 16, 2021	• The king calls for parliament to reconvene as soon as possible to allow debate of emergency ordinances and a coronavirus recovery plan. • No need to extend the emergency beyond Aug. 1, says the nine-member conference of rulers, which includes the king.
July 7, 2021	• Muhyiddin names UMNO lawmaker and defence minister Ismail Sabri Yaakob as his deputy to shore up support.
July 8, 2021	• UMNO withdraws support and calls on Muhyiddin to resign for mishandling the pandemic.
July 26, 2021	• Muhyiddin calls a special session of parliament at the king's request. Law Minister Takiyuddin Hassan tells parliament the government will not ask the king to extend the state of emergency and says emergency ordinances revoked.
July 29, 2021	• In a rare public rebuke, the palace says the revocation of emergency ordinances was done without the king's consent and runs counter to the constitution and the law.
Aug 3, 2021	Muhyiddin agrees to consider debating emergency laws in parliament, easing a standoff with the monarchy.
Aug 4, 2021	• Muhyiddin insists he retains majority support and says will prove it in a confidence vote when parliament reconvenes in September.
Aug 13, 2021	• Muhyiddin acknowledges he does not have a majority. He urges opposition lawmakers back him in a confidence vote in exchange for reforms and says elections will be held by July 2022, depending on the pandemic. • Opposition parties and UMNO reject the offer.
Aug 16, 2021	• Muhyiddin tenders his resignation to the king who asks him to stay on as interim premier until a new appointment is made.

Source: Chu (2021)

RESEARCH METHOD

This study uses purposeful sampling in selecting the speeches known as special addresses by Muhyiddin Yassin during his appointment as Prime Minister. Purposeful sampling is widely used in qualitative research for the identification and selection of information-rich cases related to the phenomenon of interest (Marshall, 1996; Palinkas et al., 2015). This study deals with four special addresses from his first 100 days in office and during the last 100 days of his premiership. In addition, this study has also conducted an interview session with Mr. Zulkiflee Bakar, a journalist who is following Muhyiddin Yassin's speeches, respectively.

Data Analysis

In this study, thematic analysis (TA) is applied to analyse the textual speeches and the interview session. TA is of great relevance for communication research using qualitative data for two reasons. First, it is a widely applicable and cost-effective means of exploratory research. Second, one understanding of TA constitutes the essential starting point of virtually all qualitative data analysis (Herzog et al., 2019). TA has been referred to as possibly the most widely used qualitative method of data analysis (Braun & Clarke, 2006). In its essence, TA consists of the analytical construction of (a) codes, (b) themes in qualitative verbal expressions; and (c) patterns of recurrence, evaluation, or associations within these themes (Herzog et al., 2019).

DIMENSIONS OF EFFECTIVE PUBLIC SPEAKING (EPS) IN TEXTUAL SPEECH

Thematic Analysis was employed to determine the Dimensions of Effective Public Speaking (EPS). Using a thematic analysis (Braun & Clarke, 2006; Herzog et al., 2019) methodological approach, this study analysed the data from four special addresses and an interview to examine the dimensions of effective public speaking (EPS) in the context of Tan Sri Muhyiddin Yassin. Based on the TA conducted on four special addresses (Speech 1 and Speech 2: first 100 days in office) and Speech 3 and Speech 4: during the last 100 days of his premiership), there are three dimensions found in each of the special addresses. They are logos, ethos, and pathos. According to Baccarani and Bonfanti (2015), the foundation of effective public speaking consists of these dimensions. Speech 1 is related to COVID-19, Speech 2 relates to the economy, Speech 3 is related to society, and Speech 4 relates to governance.

Logos Dimension

The logos dimension is found in all special addresses. It includes the variables: communicate something new, express a particular point of view, logical thinking, clear, focus, facts, stimulate curiosity, clarity, and easy to follow. For instance, in Speech 1 related to the COVID-19 pandemic, Muhyiddin Yassin delivered his speech that includes both communicating something new and expressing a particular point of view as stated below:

“Tonight, I stand before you once again, to update you on the current situation regarding the Covid-19 pandemic that has caused great distress not just in Malaysia, but also throughout the world. To date, Covid-19 has spread over 135 countries.”

The variables also appeared in Muhyiddin's second speech, which is related to economics as follows:

“Through these initiatives, I believe financial institutions will be able to provide the needed support to viable SMEs especially in weathering the current economic challenges.”

“This measure is important to enabling the companies to continue to be able to retain employment and immediately resume their business activities. This initiative is worth at least RM100 billion. I am confident this initiative will provide relief to borrowers.”

The variables also have been identified in Speech 3 as follows:

“To date, it is reported that more than 119 Palestinians have been killed and hundreds more injured, because of the Israeli regime's inescapable attacks. This tyrannical and outrageous attack is deeply disturbing to Muslims not to mention that it takes place during the holy month of Ramadan which continues until the month of Syawal when Muslims around the world are celebrating Eid al-Fitr.”

“However, we in Malaysia are deeply saddened to remember the plight of our brothers and sisters on Palestinian soil. Not only do they have to endure a very difficult life.”

“To date, the UN Security Council has not issued any statement regarding the current situation in Palestine due to opposition from the United States. Nevertheless, Malaysia will continue to seek to call on the international community, especially the UN Security Council, to act immediately to force Israel to stop attacks against Palestinians.”

In the context of governance, Speech 4, Muhyiddin also communicates something new and expresses a particular point of view as below:

“Yesterday I received a warrant from His Majesty the Yang di-Pertuan Agong informing me that eight UMNO MPs had written to the President of the House of Representatives that they had withdrawn their support to me.”

Also, Muhyiddin Yassin included the variables of logical thinking in his four speeches as stated below:

“There have been 162,711 confirmed Covid-19 cases globally. From that number, 6443 deaths have been recorded. In Malaysia, there was a sharp rise in the number of cases: 190 cases were recorded yesterday, and an additional 125 cases today. The total number of cases now stands at 553 cases. From that number, 511 are being treated, whereas 42 have fully recovered.”

“Please listen carefully, I would like to calculate the benefit that Makcik Kiah's family will derive.”

“I believe that peace-loving Malaysians stand firm to the stance that there is no compelling reason for the disproportionate, reckless, and extreme use of force against Palestine and strongly rejects the Israeli regime's heinous actions against the Palestinians.”

Ethos Dimension

The ethos dimension is found in all special addresses. The variables consist of position of leadership, awareness, trustworthiness, authenticity, sincerity, reasonable, beliefs, portray personality, and knowledge. For example, in Speech 1, Muhyiddin Yassin delivered his speech that shows his position of leadership as stated below:

Muhyiddin Yassin has clearly stated his position of leadership as “Government” in his Speech 1 concerning COVID-19 as follows :

“The Government takes this current trend very seriously, especially the rise of the second wave of new infections.”

“To that end, the Government has decided to implement a nationwide Restriction of Movement Order beginning 18th of March until 31st of March.”

His position of leadership also appeared in Muhyiddin’s second speech as follows:

“The Government’s immediate priority now is to curb the spread of the COVID-19 outbreak.”

“In the previous package, the Government provided special allowances to doctors, nurses and medical staffs involved directly in curbing and preventing the outbreak.”

“To assist those affected, the Government will implement the following measures.”

In Speech 3, this variable also appears as stated below:

“The Malaysian government will be represented by the Minister of Foreign Affairs to participate in the meeting to reaffirm Malaysia's stance on the situation in Palestine.”(#3/14)

“In addition, to assist the Palestinian Government in curbing the COVID-19 pandemic, the Government of Malaysia also provided assistance to Palestine”(#3/21)

Also, his position of leadership is demonstrated in Speech 4:

“Meanwhile, the Cabinet and the administrative machinery of the government will continue to function to carry out the trust and responsibility to the people and the country, especially in addressing the Covid-19 pandemic.”

“Similarly, the aid announced by the government will be acceptable to the people without any obstacles.”

Pathos Dimension

Pathos dimension is found in all special addresses. The variables include empathy, inciting emotions, interpersonal communication skills, simple, personal stories, and storytelling abilities. For instance, in Speech 1 related to the COVID-19 pandemic, Muhyiddin Yassin delivered his speech that includes empathy as stated below:

“Naturally we do not wish to see such similar developments take place in our country.”

“I would like to take this opportunity to convey my heartfelt thanks to all our front liners, health workers, civil servants, and all parties who are working non-stop, day and night to help us resolve this Covid-19 problem.”

The variable also appeared in Muhyiddin’s second speech, which is related to economics. For instance:

“The PRIHATIN package will provide immediate assistance to ease the burden faced by all of you.”

“To ease their burden, the Government will provide a one-off cash assistance of RM500 to 120,000 e-hailing drivers with a total allocation of RM60 million.”

To assist B40 entrepreneurs and people who lose their jobs,...

“As announced yesterday, to express our concern and care for the plight of the people in facing this difficult situation,...”

Muhyiddin Yassin has also shown his empathy in terms of the Palestine issue (Speech 3). This includes:

“However, we in Malaysia are deeply saddened to remember the plight of our brothers and sisters on Palestinian soil. Not only do they have to endure a very difficult life.”

“I, like other Malaysians, feel deep sorrow and regret at the inability of the international community, especially, the UN Security Council, to immediately cease the Israeli regime's violence against Palestine.”

Also, his empathy is demonstrated in Speech 4. For example:

“First of all, I would like to apologize to my brothers and sisters for the fact that in the face of great challenges in tackling the Covid-19 pandemic”

This is in line with an interview conducted with Mr. Zulkiflee Bakar. He stated that Muhyiddin Yassin’s empathy towards the rakyat who are facing job loss and difficulties in life has brought him to come out with PRIHATIN Economic Stimulus Package (ESP) worth RM350 billion is a genuine effort, which was announced in Speech 2.

THE EFFECT OF THE DIMENSIONS OF EFFECTIVE PUBLIC SPEAKING (EPS) TOWARDS BUILDING LEADERSHIP BRAND

According to Mr. Zulkiflee, the dimension of effective public speaking (EPS) by Muhyiddin Yassin does not affect his leadership brand. He has the logos dimension in terms of delivering a clear, focus and facts speech. Also, he has the ability to incite emotions and interpersonal-communication skills which are able to attract the rakyat. Nonetheless, his famous leadership brand, “Abah” has been created by his communication team from the moment he became the prime minister. In the first 100 days of his position as a prime minister, he did a great job by appearing on television frequently, precisely in delivering his special addresses. He became famous in the sense of his simple and humble appearance, thus making them feel comfortable listening to his speech. His empathy (Pathos dimension) towards the rakyat who are facing job loss and difficulties in life has brought him to come out with PRIHATIN Economic Stimulus Package (ESP) worth RM350 billion is a genuine effort. The ESP announcement as stated in Speech 2 made the people could not wait for his speech the day onwards. Nevertheless, the following special addresses failed to meet people’s expectation towards him since no more assistance or incentives were given to them. From then on, his crowd has reduced day by day. Frequent special addresses have made people feel uneasy of him. Thus, making the opposition political parties to bring him down from his premiership.

CONCLUSION

This study determines the dimensions of Effective Public Speaking (EPS) in textual speech and explores the effect of the dimensions of EPS towards building leadership brand from the context of Muhyiddin Yassin, the 8th Malaysian Prime Minister. Based on the analysis, it is found that all dimensions of EPS existed in all of Muhyiddin Yassin’s special addresses. Also, the TA based on the interview supported that all the dimensions appeared in Muhyiddin Yassin’s speeches.

The study also explores the effect of the dimensions of EPS towards building a leadership brand from the context of Muhyiddin Yassin, the 8th Malaysian Prime Minister. The TA has been used to analyse the interview session conducted with Mr. Zulkiflee Bakar, a journalist who has been following Muhyiddin Yasin’s speeches. the dimension of effective public speaking (EPS) by Muhyiddin Yassin does not affect his leadership brand. His famous leadership brand, “Abah” has been created by his communication team from the moment he became the prime minister. This contradicted the previous studies which resulted in a strong link between public speaking and leadership brand (Anderson, 2016; Wyne, 2017). With the power of effective public speaking skills and storytelling about ones brand, the person will be able to build a stronger more loyal audience (Anderson, 2016; Wyne, 2017). Also, the result

of this study is opposed to a study conducted by STUDY.365.co.uk. which found that effective public speaking influenced the leadership brand (STUDY365.co.uk., 2016).

REFERENCES

- Akbal. (2020, June 10). Muhyiddin: Perdana Menteri Kurang Sangat Berpolitik. BH Online. <https://www.bharian.com.my/berita/nasional/2020/06/698510/muhyiddin-perdana-menteri-kurang->
- Anderson, C. (2016). TED Talks - The Official TED Guide to Public Speaking. Houghton Mifflin Harcourt.
- Baccarani, C., & Bonfanti, A. (2015). Effective public speaking: A conceptual framework in the corporate-communication field. *Corporate Communications*, 20(3), 375–390. <https://doi.org/10.1108/CCIJ-04-2014-0025>
- Barrett, Deborah. (2006). Leadership Communication: A Communication Approach for Senior-Level Managers. <chrome-extension://efaidnbnmnibpcjpcglclefindmkaj/viewer.html?pdfurl=https%253A%252F%252Fscholarship.rice.edu%252Fbitstream%252Fhandle%252F1911%252F27037%252FLeadership%252520Communication%252520-%252520A%252520Communication%252520Approach%252520for%252520Senior-Level%252520Managers%252>
- Bates, S. (2007). The eight most frequent mistakes people make in front of an audience. *Business Strategy Series*, 8(4), 311–317. <https://doi.org/10.1108/17515630710684367>
- Beason, L. (1991). Strategies for Establishing an Effective Persona: An Analysis of Appeals to Ethos in Business Speeches. *Journal of Business Communication*, 28(4), 326–346. <https://doi.org/10.1177/002194369102800403>
- Berkun, S. (2009). Confessions of a Public Speaker. O'Reilly Media, Inc.
- Bottles, K. (2010). If I can learn to become a great speaker, anyone can. *Physician Executive*, 36(5), 76–79.
- Braun, V., & Clarke, V. (2006). Applied Qualitative Research in Psychology. *Qualitative Research in Psychology*, 3, 77–101. <https://doi.org/10.1057/978-1-137-35913-1>
- Chu, M. M. (2021, August 16). The rise and fall of Malaysia's Muhyiddin Yassin. Reuters. <https://www.reuters.com/world/asia-pacific/rise-fall-malysias-muhyiddin-yassin-2021-08-16/>
- Chu, M. M., Latiff, R., & Lee, L. (2021, August 16). Malaysian PM Muhyiddin resigns as political crisis escalates. Reuters.
- Clark, T., & Greatbatch, D. (2011). Audience perceptions of charismatic and non-charismatic oratory: The case of management gurus. *Leadership Quarterly*, 22(1), 22–32. <https://doi.org/10.1016/j.leaqua.2010.12.004>
- Daniels, J. (2005). The art of making persuasive presentations. *Employment Relations Today*, 31(4), 39–49. <https://doi.org/10.1002/ert.20040>
- Denning, S. (2008). How leaders can use powerful narratives as change catalysts. *Strategy and Leadership*, 36(2), 11–15. <https://doi.org/10.1108/10878570810857528>
- Frese, M., Beigel, S., & Schoenborn, S. (2003). Action training for charismatic leadership: Two evaluations of ... *Personnel Psychology*, 56(3), 671–697.
- Glagola, C. (2008). My first public speaking experience, and other tales from H#\$. *Leadership and Management in Engineering*, 8(1), 1–5. [https://doi.org/10.1061/\(ASCE\)1532-6748\(2008\)8:1\(1\)](https://doi.org/10.1061/(ASCE)1532-6748(2008)8:1(1))
- Herzog, C., Handke, C., & Hitters, E. (2019). Analyzing Talk and Text II: Thematic Analysis. In *The Palgrave Handbook of Methods for Media Policy Research* (Issue April, pp. 385–401). https://doi.org/10.1007/978-3-030-16065-4_22

- Jaes, L., Razali, N. A., & Mohamad Suhaimy, K. A. (2020). Mahathir as the Prime Minister: Peak of “Paternalistic Leadership” in Malaysia. *Journal of Social Transformation and Regional Development*, 2(1), 42–51. <https://doi.org/10.30880/jstard.2020.02.01.005>
- Jaes, L., Razali, N. A., Yusof, A. M. M., & Suhaimy, K. A. M. (2021). 100 Days of Muhyiddin’s Government Leadership: A Manifestation of the Continuity of Paternalism Values. *Turkish Journal of Computer and Mathematics Education (TURCOMAT)*, 12(2), 755–763. <https://doi.org/10.17762/turcomat.v12i2.1081>
- Luthra, A., & Dahiya, D. R. (2015). Effective Leadership is all About Communicating Effectively: Connecting Leadership and Communication. *International Journal of Management & Business Studies*, 5(3), 43–48.
- Marshall, M. N. (1996). Sampling for qualitative research. *Family Practice*, 13(6), 522–525. [https://doi.org/10.1016/S0001-2092\(06\)61990-X](https://doi.org/10.1016/S0001-2092(06)61990-X)
- Mehta, N. K. (2018). Enhancing engineers’ public speaking efficacy using appreciative inquiry. *Industrial and Commercial Training*, 50(2), 81–94. <https://doi.org/10.1108/ICT-05-2017-0035>
- Murray, W. (2007). What’s your story? Corporate messages to touch the soul. *Strategic Direction*, 23(5), 3–4. <https://doi.org/10.1108/02580540710743022>
- Nasrudin, M. (2005). A Brief Look at the Malaysian Prime Ministers’ Leadership Styles. *Journal of Administrative Science*, 2(1), 39–54.
- Palinkas, L. A., Horwitz, S. M., Green, C. A., Wisdom, J. P., Duan, N., & Hoagwood, K. (2015). Purposeful sampling for qualitative data collection and analysis in mixed method implementation research. *Adm Policy Ment Health.*, 42(5), 533–544. <https://doi.org/10.1007/s10488-013-0528-y>. Purposeful
- Psenicka, C., Kos, A., & Vendemia, W. (2012). The determinants of effective presentations: a factor analytic investigation. *International Journal of Management*, 29(3), 314–320.
- Rais, M. M. (2021, August 16). A leader we can be proud of. *New Straits Times*. <https://www.nst.com.my/opinion/letters/2021/08/718387/leader-we-can-be-proud>
- Randall, D., & Harms, A. (2011). Using stories for advantage: The art and process of narrative. *Strategy and Leadership*, 40(1), 21–26. <https://doi.org/10.1108/10878571211191666>
- Roos, J. (2013). The benefits and limitations of leadership speeches in change initiatives. *Journal of Management Development*, 32(5), 548–559. <https://doi.org/10.1108/02621711311328318>
- Sherman, R. (2001). Make a powerful presentation. *IEE Solutions*, 33(11), 26–28.
- STUDY365.co.uk. (2016). How to Build Your Personal Brand with Effective Public Speaking Skills. *STUDY365.Co.Uk*. <https://www.study365.co.uk/how-to-build-your-personal-brand-with-effective-public-speaking-skills/>
- Tun Sheikh Engku Bendahara. (2010). Tan Sri Muhyiddin Yassin. <http://sejarah-tunsheikh.blogspot.com/2010/01/tan-sri-dato-hj-muhyiddin-yasin-kini.html>
- Vasudevan, M. (2019). How Public Speaking Instantly Increases Your Personal Brand Value and Influence. *Thought Expressions!* <https://thoughtexpressions.com/how-public-speaking-instantly-increases-your-personal-brand-value-and-influence/>
- Wyne, H. (2017). The link between leadership and public speaking. *LinkedIn*. <https://www.linkedin.com/pulse/link-between-leadership-public-speaking-hisham-wyne/>
- Yale, R. N. (2014). The Impromptu Gauntlet: An Experiential Strategy for Developing Lasting Communication Skills. *Business Communication Quarterly*, 77(3), 281–296. <https://doi.org/10.1177/2329490614537874>

Techniques to Identify The Themes in Qualitative Data Among The Hysteria Malay Students in Secondary School

Nagarubini Paramasivam
Universiti Malaysia Kelantan
rubininaga8@gmail.com

ABSTRACT

This qualitative study was conducted to identify the themes among Malay students using a clinical psychology approach in Kelantan's schools, which help to find out the experiences, levels of anxiety, stress, and depression, personalities of hysteria students, and factors of mass hysteria outbreaks. The site population comprised four high schools in Kelantan where hysteria episodes were happened. The target population were school students who experienced hysteria in high schools in Kelantan. The population total were 80 students involved in hysteria based on teachers' information from the four schools, but only 50 students voluntarily participated in this research. Ten respondents were selected from 50 students for an in-depth interview. This research employed a non-probability sampling approach, whereby not every element of the population had an opportunity to be included in the sample. Therefore, snowball sampling was used, during which early informants were requested to make referrals to other participants. Findings of this qualitative study showed that there are two types of profiles in this research which are the general profile and the specific profile. For the general profile, the researcher used two psychological tests, which are the DASS test and the drawing test. The DASS-21 was used as a screening tool to identify the level of depression, stress and anxiety among 50 hysteria respondents. The tests indicated that the respondents were having the highest prevalence of anxiety and depression. Meanwhile, the drawing test was used for to see the personality among the 50 respondents.

Keyword: *Qualitative, DASS-21, drawing test, Malay students, hysteria, school*

INTRODUCTION

For many years, hysteria has been a contentious topic, with continuous discussions regarding whether it is better described by undiscovered organic reasons or by overreacting and lying (Vignemont, 2009). In order to provide a conceptual framework for hysteria, researchers in the disciplines of psychology, psychiatry, and alternative Islamic medicine have made an effort to gather data. According to earlier research, hysteria typically affects teenage girls and women (Atkins, 1953). According to cases that have happened in Malaysia, hysteria is widespread in young women, particularly in students. Because of this, this study employs a qualitative methodology with interviews to determine the causes, symptoms, and management of hysteria. Respondents included 10 students in a secondary school in Kelantan who had experienced hysteria.

CONCEPT OF HYSTERIA

American Psychological Association changed their diagnosis of "hysterical neurosis, conversion type" to that of "[conversion disorder](#)." (American Psychiatric Association, 2013). Today, psychology recognizes different types of disorders that were historically known as hysteria, including dissociative disorders and somatic symptom along with related disorders. Hysteria is undoubtedly the first mental disorder attributable to women, accurately described in the second millennium BC, until Freud considered it an exclusively female disease. Over 4000 years in history, this disease was considered from two perspectives: scientific and

demonological. It was cured with herbs, sex or sexual abstinence, punished and purified with fire for its association with sorcery, and finally, clinically studied as a disease and treated with innovative therapies (da Mota Gomes & Engelhardt, 2014).

However, even at the end of the 19th century, scientific innovation had still not reached some places, where the only known therapies were those proposed by Galen. During the 20th century, several studies postulated the decline of hysteria amongst occidental patients (both women and men) and the escalating of this disorder in non-Western countries. The concept of hysterical neurosis is related to the 1980 DSM-III. The evolution of these diseases seems to be a factor linked with social “westernization” and examining under what conditions the symptoms first became common in different societies became a priority for recent studies over the risk factor (da Mota Gomes & Engelhardt, 2014).

LITERATURE REVIEW

Hysteria as a condition or illness resembling a physical disease occurring in persons with healthy bodies has been known since antiquity. Mass hysteria, as a mysterious phenomenon, for over many years in different historical periods, different cultural groups, and communities has also been described as conversion hysteria and dissociative reaction or neurosis - that is, a neurosis that occurs in response to emotional stress, involving a sudden loss or impairment of mental functions (Sujit, 2009). Such reactions may arise from a causal role played by unconscious conflicts that evoke anxiety and lead to the use of defence mechanisms that ultimately produce observable symptoms. Hysteria may be of the conversion type, in which the senses of the voluntary nervous system are involved, or of the dissociative type, in which the person’s state of consciousness is affected (Sujit, 2009).

Mass psychogenic illness (MPI) is a not a very rare phenomenon anymore. It is probably more common than the reported incidences and imposes a significant financial burden and unexpected management difficulties for the emergency department (Balaratnasingam & Janca, 2006). Affected schools or occupational sites are often closed for days or weeks (B. Jones, Bowd, & Tench, 2009). It can be defined as “the rapid spread of illness signs and symptoms affecting members of a cohesive group, originating from a nervous system disturbance involving excitation, loss, or alteration of function, whereby physical complaints that are exhibited unconsciously have no corresponding organic etiology” (Bartholomew & Wessely, 2002). Outbreak of mass psychogenic illness often starts with an environmental trigger such as a bad smell, a sound, a suspicious looking substance, or something else that makes people in a group believe that they have been exposed to a danger and they start to experience symptoms of illness (Pastel, 2002; Small, Feinberg, Steinberg, & Collins, 1994).

FACTORS THAT CONTRIBUTE TO HYSTERIA

There are some factors that contribute to hysteria. These factors affected the victims by giving them psychological problems.

Aggression

Hysteria confronts the physician with a fear of missed diagnosis which can lead to additional examinations over prescription. Given the lack of organic causes, it can also increase attitudes of aggression and rejection towards the patients, even leading to abandonment of treatment (Docquir, 2013).

It is crucial for the patient and his entourage to understand that the hysteria can originate from psychological roots in the complex interactions between the mind and body. An unconscious stress factor, usually unknown to the patient, triggers an emotional response that is then converted into a physical symptom. To build trust, it is essential to let the patient know that the symptoms are real; it does not simulate or intentionally amplify them (Catherine et al., 2013).

Anxiety

The anxiety disorders are the most common, or frequently occurring, mental disorders (Munir, Gondal, & Takov, 2019). They encompass a group of conditions that share extreme or pathological anxiety as the principal disturbance of mood or emotional tone. Anxiety, which may be understood as the pathological counterpart of normal fear, is manifested by disturbances of mood, as well as of thinking, behaviour, and physiological activity. According to Munir et al., (2019) the anxiety disorders include panic disorder (with and without a history of agoraphobia), agoraphobia (with and without a history of panic disorder), generalized anxiety disorder, specific phobia, social phobia, obsessive-compulsive disorder, acute stress disorder, and post-traumatic stress disorder. In addition, there are adjustment disorders with anxiety features and disorders due to general medical conditions and substance-induced anxiety disorders (Greenberg et al., 1999).

There are two main types of mass psychogenic illness (MPI). The most common in Western countries (anxiety hysteria) is triggered by extreme, sudden stress within a close-knit group. It is usually triggered by a foul or unfamiliar odour that is perceived to be harmful. Symptoms are transient, benign, and typically include dizziness, headache, fainting, and over-breathing (Wessely, 1987). Most victims recover within 24 hours and there is an absence of pre-existing tension within the group. A second type (motor hysteria) arises from long-term anxiety and features motor agitation. Common symptoms include twitching, shaking, trouble in walking, uncontrollable laughing and weeping, communication difficulties, and trance states. Symptoms appear slowly over weeks or months under exposure to longstanding stress, and typically take weeks or months to subside after the stress has been reduced or eliminated (Wessely, 1987).

Anxiety arises when these unacceptable and repressed drives threaten to enter consciousness; prompted by anxiety, the conscious part of the mind (the ego) tries to deflect the emergence into consciousness of the repressed mental contents through the use of defence mechanisms such as repression, denial, or reaction formation. Neurotic symptoms often begin when a previously impermeable defence mechanism breaks down and a forbidden drive or impulse threatens to enter consciousness (Britannica, 2021).

Stress

Stress is commonly mentioned as a contributing cause of hysteria (Bartholomew & Wessely 2007; Lee & Tsai, 2009; Smeehuijzen, 2012). Some researchers argue that hysteria or psychogenic illness is caused by pent-up stress at schools and factories, as well as fear of environmental intoxication (Goh 1987; Jones 2000; Nair 2009; Ross 2001). Some researchers contend that stress related to examinations can cause mass psychogenic illness episodes (Nair, 2009). Nair (2009) states that outbreaks of hysteria which were reported in three Gauteng schools, three KwaZulu-Natal schools and one Eastern Cape school in South Africa were described by a child and adolescent psychiatrist as stress-related.

News 24 (2001) reported on an outbreak of mass hysteria in Kuala Lumpur, Malaysia. Thirty school girls experienced screaming and fainting episodes. The educational officials attributed the encounter as psychological and psychosomatic. The girls were due to sit for a

nationwide end of year examination. Some authors relate mass hysteria to the psychological stress as a result of inhibited emotional ventilation (Sharma et al., 2010). Bartholomew & Sirois (2000) purport that Islamic Malaysian females lack channels of communication with the employees, despite their dissatisfaction and long working hours.

THE PSYCHOANALYTIC THEORY

Sigmund Freud's psychoanalytic theory and treatment (therapy) of hysteria asserted that hysteria was a psychological disease with quasi-physical symptoms. His emphasis was on the psychological mechanism of hysterical symptom formation. His contention was that the hystero-genesis rests in the repression of traumatic memories. According to Gilman et al. (1993), memories are thought to be in the remote past of the individual and are invariably libidinal or sexual in content. Because the remembering of such memories is hurting and unpleasant, they are unable to find conscious psychological expression; the negative emotional energy expression is associated with these memories, which are then unconsciously converted into somatic manifestations as demonstrated in the mass hysteria vignettes earlier. Therefore, in the process of hysterical conversion, symptoms are not arbitrary and/or meaningless phenomena, but complex symbolization of repressed psychological experiences. Though the repressive mechanism part of the mind tries to keep itself away from consciousness of all unwanted impulses of the individual, and this fosters the ego's growth. In short, in psychoanalytic psychology, the body (soma) is the physical field on which wishes, anxieties, and traumas of stresses and intrapersonal conflicts are dramatized (Sigmund Freud 1885–1900 in Gilman, et al., 1993).

METHOD

This section presents the narrative data collected through psychological tests among 50 general hysteria students and a selected 10 individuals that often experience hysteria who were held for individual in-depth interviews. The researcher reviewed the field notes, listened to the audio recordings, transcribed, read and re-read the verbatim transcripts, in order to familiarise herself with the data and to develop a general impression of the interviews. After that, the researcher worked on each verbatim transcript sequentially, according to the order of data collection. The next step was the analysis of individual transcripts, followed by triangulating the psychological tests with the interviews to generate the themes in discussion. This research employed a non-probability sampling approach, whereby not every element of the population had an opportunity to be included in the sample (Burns & Grove 2005). Non-probability sampling is the non-random selection of elements for a sample. Qualitative research requires a small sample until completeness; the sample is therefore not predetermined, but depends on data saturation (LoBiondo-Wood & Haber, 2010; Streubert & Carpenter, 1999). Burns & Groove (1999) purport that such a sample is not representative. It provides the means to reach these unique subjects with the rare experiences.

Tjale & Villiers (2004) argue that large samples, when used in qualitative research, yield and generate an amount of data that becomes difficult to manage and analyse in a meaningful way. Therefore, qualitative research advocates for small samples. In qualitative research, the focus is more on the quality of the data. According to Burns & Grove (2009), when the data's quality and richness are high, only a few participants saturate the data meaning when no new information emerges. In this research, the researcher did not know who would be a qualified participant, hence, the 'snowball' technique was used to recruit students.

Summary of All Tests For The 50-General Profiling

Fifty hysteria students had been chosen to complete the DASS-21 test and the drawing test to identify common hysteria problems among Malay students. In the drawing test, the respondents mostly have depression and anxiety. This is supported by the DASS-21 test, which found 30 respondents in the anxiety stage and 17 respondents in the depression stage. Next is the drawing test. The respondents were found to be having an easily distracted mind and to be living in the past. They suppressed their feelings and became rebellious. This indicates most respondents have depression, as supported in the DASS-21 test.

Population

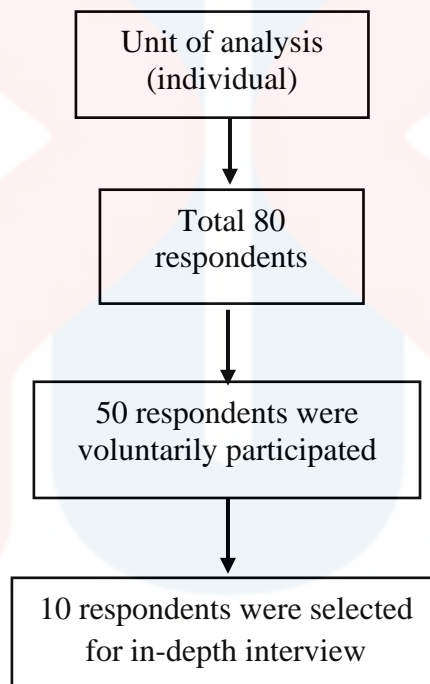
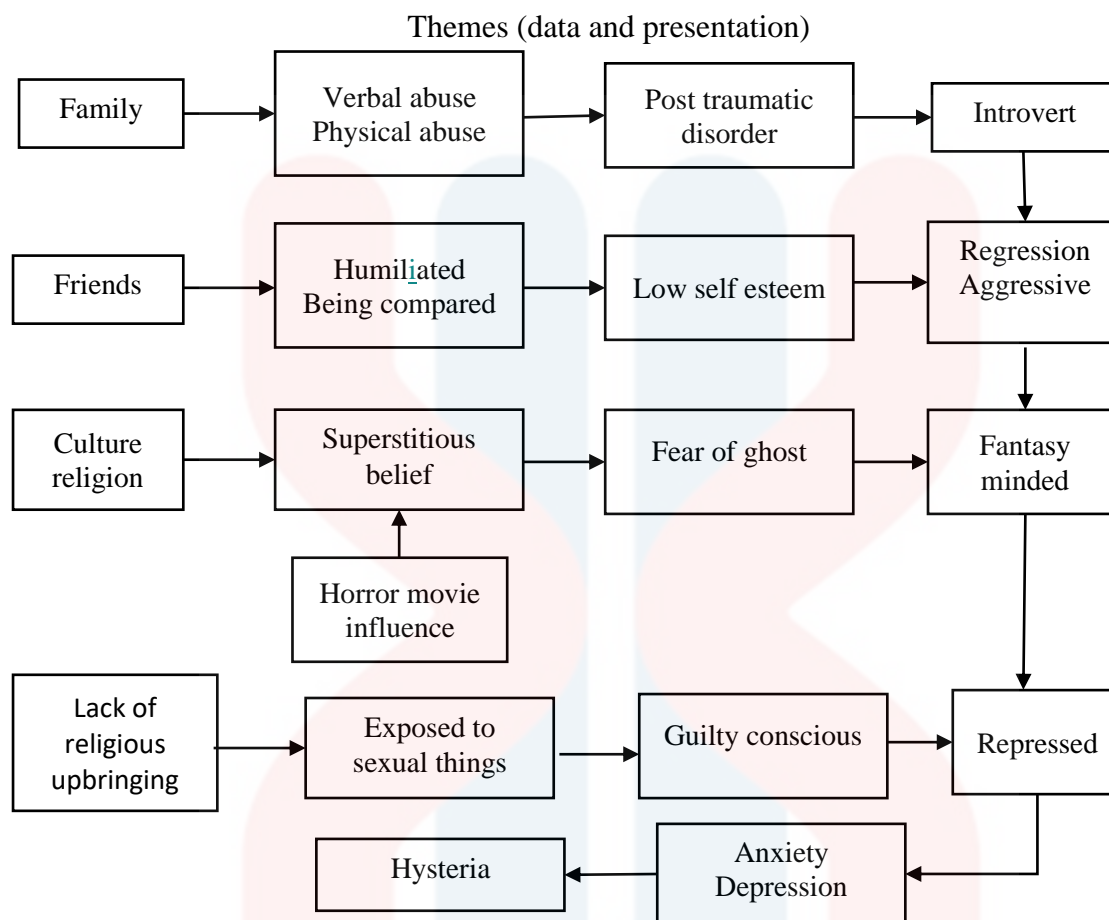

Figure 1.1 Shows the unit analysis of population



The themes started with family, the respondents should deal with the family issues like verbal abuse and physical abused and it creates post traumatic disorder, and because of that the respondents become introverts. Second is friends, the respondents had been compared with them and humiliated; the result is that the respondents have low self-esteem and this pushed the respondents to become regressed which leads them to be aggressive.

The respondents are influenced by culture and religion, which makes them superstitious. The respondents are then influenced by horror movies, which creates extraordinary fear of ghosts among respondents and they become fantasy-minded. Final theme is lack of religious upbringing. Because of poor teaching of religion, respondents are exposed to unwanted events like sexual things, and they become guilty. This makes them repressed.

Therefore, once they become introverts, they keep everything within themselves and do not share their problems with anyone. This is called regression. The regression is a coping method to avoid problems. The emotions and the feelings hidden within them will lead to an aggressive person, and that is why in the interview the respondents started hitting themselves. Hence, the emotion and the aggression is combined with the influence of horror movies.

The respondents started to be fantasy-minded. They imagined that they were possessed by ghosts and claimed that they could see ghosts. Then, they are repressed by past actions like sexual abuse and trauma. Once everything is combined together, all of these lead to depression and anxiety, and the outcome is hysteria.

CONCLUSION

The experiences of respondents in the school reveal that the Kelantan's belief in the supernatural, and their culture which regard girls as weaker and socialises them to be

submissive (allowing for accumulation of pent-up stress), provide a strong breeding ground for mass hysteria. Moreover, the stress, anxiety, and depression leads them to get hysteria, and they are unable to express their emotions and feelings. Their belief in the supernatural potentially exposes them to suggestions, imagined stimuli, misunderstanding, uncertainties and confusion, which may give rise to irrational fears and the contagious effect of mass hysteria.

Students who fall victim to mass hysteria episodes in Kelantanese schools are affected by psychological factors, their family's background, culture and religion. Overall, the objectives were reached by the psychological tests and the interviews. This shows the students are having mental health problems but deny them because of supernatural beliefs.

REFERENCES

- American Psychiatric Association (2000) Diagnostic and Statistical Manual of Mental Disorders, 4th Edition, Text Revision. Washington, DC, American Psychiatric Association
- Atkins, H.J.B.1953.Refresher Course for General Practitioners Hysteria.British Medical Journal.UK: University of Edinburg.
- Catherine E. Krasnik, Brandon Meaney, Christina Grant. (2013) .Une approche clinique des troubles de conversion en pédiatrie: vers un retour à la normale. PCSP.
- Bartholomew, R.E, & Sirois, F. (2000). Occupational Mass Psychogenic Illness: A Transcultural Perspective. *Transcultural Psychiatry* 37(4):495-524.
- Burns, N. & Grove, S.K. (2005). The Practice of Nursing Research; Conduct, Critique And Utilization.5 th edition. St Louis, Mo: Elsevier/ Saunders.
- Da Mota Gomes, M., & Engelhardt, E. (2014). A neurological bias in the history of hysteria: from the womb to the nervous system and Charcot. *Arquivos de Neuro-Psiquiatria*, 72(12), 972–975. <https://doi.org/10.1590/0004-282X20140149>
- Docquir C. Les symptômes médicalement inexpliqués: précisions terminologiques, données épidémiologiques chez l'adulte et l'enfant, aperçu des contre-attitudes. *Bulletin de psychologie* 2013; 523: 61-75.
- Munir, S., Gondal, A.Z., & Takov, V., (2019). Generalized anxiety disorder. <https://www.ncbi.nlm.nih.gov/books/NBK441870>
- Sujit, S. (2009). Kaplan and Sadock_s Synopsis of Psychiatry (10th ed). *Indian Journal of Psychiatry*, 51(4), 331.
- Lee, R.L. & Tsai, S.J. (2009). Online: <http://www.elsevier.com/locate/mehy>. [Accessed 30 November 2010].
- Nair, N. (2009). *School hysteria is 'Stress-related'*. Online: <http://www.thetimes.co.za/News/Article.aspx?id=972384>. [Accessed 4 August 2009].
- Pastel, R.H. 2002. Collective behaviours: Mass Panic and Outbreaks of Unexplained Symptoms. *Military Medicine* 166(12):44-6.
- Gilman, S.L., King, H., Porter, R., Rousseau, G., & Showalter, E. (1993). *Hysteria beyond Freud*. Berkely: University of California Press.
- Greenberg N, Brooks S, Dunn R. Latest developments in post-traumatic stress disorder: diagnosis and treatment. *British Medical Bulletin*, 2015: 1–9.
- Wessely, S. (1987). Mass Hysteria: two syndromes. *Psychological Medicine*, 17, 109-120.

Study on The Consumer Attitudes Towards Digital Shopping During the Pandemic in Johor Bahru

Norfazlirda Hairani
Universiti Malaysia Kelantan
fazlirda.h@umk.edu.my

Zuhayra Khayrin Zaini
Universiti Malaysia Kelantan
zuhayra.a18a0966@siswa.umk.edu.my

Nik Syuhailah Nik Hussin
Universiti Malaysia Kelantan
niksyuhailah@umk.edu.my

ABSTRACT

The outbreak of the pandemic significantly changes the norms of daily life. Thus, the empirical study analyses consumer attitudes toward digital shopping in Johor Bahru. A non-probability sampling method was used to perform the analysis, and the questionnaire was distributed to 384 respondents. This study empirically showed that consumer beliefs, feelings, and behavioral intentions positively influence consumer attitudes. From the analysis, it can be concluded that these three theories are acceptable. The most significant factor positively affects consumer attitudes toward digital shopping during the pandemic outbreak is consumer behavioral intentions. Hence, it provides suggestions and recommendations to the retail players and researchers for future studies. Finally, the study thoroughly explains the disadvantages and makes some suggestions.

Keywords: Behavioral Intentions; Beliefs; Digital Shopping; Consumer Attitude; Feelings; Pandemic

INTRODUCTION

Covid-19, a highly infectious novel coronavirus disease, an ongoing pandemic has strained health facilities globally. As of 31 March 2021, it has infected 129 million and killed 2.83 million people (Aw et al., 2021). On March 11, 2020, the pandemic outbreak led to unprecedented measures, and to flatten the virus, the Movement Control Order was imposed (Khan & Smith, 2020). It has significantly affected daily life and numerous sectors, consequently transforming business operations and consumer behavior (Cruz-Cárdenas et al., 2021). Most of the consumers are changing to online platforms such as Amazon, Lazada, and Shopee are mushrooming during the lockdown being implemented.

Buying and selling online or offering an online service are examples of digital shopping (AU, 2018). It entails going online, landing on a seller's website, purchasing, and arranging for delivery. Digital stores do not have space limits; therefore, a large range of items may be presented. There are various advantages to adopting a digital site for both retailers and consumers. Using a digital store, the retailers may easily compare prices with their competitors. Consumers benefit from digital shopping since it allows them to easily compare shop with different retailers. The disadvantage of using a digital store is that the consumer misses out on the purchasing experience. Remote shoppers face network issues, money being debited but not received by sellers, or payment stuck halfway through. There is also the risk that personal information will be exploited.

Consumer attitudes are a directly impacted aspect that influences consumers' purchasing willingness. Understanding consumer attitudes is one of the primary motivations for performing marketing research. According to Currie (2019), attitudes influence behaviour. The desired behaviour in advertising is to buy a product or service. Retailers must know what attitudinal hurdles exist in purchasing to strategize how to overcome such barriers through marketing efforts.

Consumer belief combines information, emotions, and actual purchases or refusals to purchase (Kirchheimer, S., 2017). Belief is essential to consumers since it may be positive or negative toward an object. According to behavioural science, a consumer's collection of ideas about the world impacts consumer behaviour. Spiritual beliefs are so profoundly established that they prevent consumers from making logical decisions assessing possibilities, perpetuating present behaviours and habits (Tamara Charm, 2020).

The present study will scope the consumer attitude toward digital shopping in southern West Malaysia, Johor Bharu hence it fulfill the gap in this study context.

RESEARCH METHODOLOGY

The study employ non probability sampling and it was carried out between October 10, 2021, until February 2022. Participants in this survey include consumers who shop online through sites like Mudah.my, Zalora, Shopee, Lazada, and Carousell. This study's population consists of the residents of Johor Bahru. According to DOSM (2021), Johor Bahru has 1,565,900 residents. The proportion of individuals refers to the number of people included in the sample size. The population of Johor Bahru, Johor is 1,565,900 residents. As per guideline in Krejcie and Morgan (1970), 384 respondents were selected to represent a population of over 100,000 people.

RESULTS

Demographic Profiles

Table 4.2.1 showed the descriptive analysis of demographic profile of respondents in this study. In analyzing of the frequency, most female respondents use digital shopping in this survey at 208 (54.2%) whereas male respondents were 176 (45.8%). The primary distinction between men and women in terms of shopping is what they purchase. Men often purchase for heavy-duty products such as furniture and computers, whereas women typically purchase for groceries and apparel. Besides, there were 165 respondents among 21 until 30 years with (43%) which were the highest, while the lowest was 21 of respondents among 51 years and above with (5.5%). This can be supported by the observation that consumers aged 21 to 30 years are more interested to purchase through a digital platform since it saves time and offers a wide range of products. Next, mostly Malay individuals like to use digital shopping which is 224 of respondents with (58.3%). That's because most Malay consumers believe that buying online is more convenient than going to crowded stores or standing in line for hours. Even better, most online businesses allow users to select same-day delivery at the checkout screen. Not only can avoid crowds and lines, but consumer also get their things swiftly. On the other hand, single consumer was highest use in digital shopping at 245 respondents with (63.8%) while the lowest is widowed and divorced that is 10 respondents with (2.6%). Single consumers prefer to shop online since it is more economically efficient. This is especially true for electronics, toys, and other leisure things. They may also apply coupons online and obtain special deals on a regular

basis. The highest of frequency in education background were SPM/STPM at 149 respondents with (38.8%). They prefer to purchase online since it is more convenient to do so from home. Their responsibilities are under the authority of their parents, and it is tough to purchase in physical stores during the pandemic. Therefore, student is the most prefer to use digital shopping during pandemic in which 180 respondents with (46.9%). That's because consumers can afford what they want through digital shopping since they can acquire thorough information about the products and compare them to other brands or models.

In Table 1 below, data showed the demographic profile of the respondents.

Table 1: Descriptive Analysis of Demographic Profile of Respondents

Demographic	Item	Frequency (n = 384)	Percentage (%)
Gender	Male	176	45.8
	Female	208	54.2
Age	Below 20 years	84	21.9
	21 – 30 years	165	43.0
	31 – 40 years	75	19.5
	41 – 50 years	39	10.2
	51 years and above	21	5.5
Race	Malay	224	58.3
	Chinese	87	22.7
	Indian	38	9.9
	Others	35	9.1
Marital Status	Married	107	27.9
	Single	245	63.8
	Widowed	10	2.6
	Divorced	10	2.6
	Others	12	3.1
Education Background	SPM / STPM	149	38.8
	Diploma	126	32.8
	Degree	102	26.6
	PhD and above	7	1.8
Occupation	Student	180	46.9
	Private sector	111	28.9
	Government sector	45	11.7
	Retiree	12	3.1
	Others	36	9.4

Descriptive analysis

Table 4.3.1: Level of Mean

Variables	Mean	Interpretation
Consumer Beliefs	4.6234	High

Consumer Feelings	4.6424	High
Consumer Behavioural intentions	4.5536	High
<u>Consumer attitude</u>	<u>4.5792</u>	<u>High</u>

Table 4.3.1 shows the mean of the independent and dependent variables. The highest average of the independent variables is feelings of 4.6424, followed by consumer beliefs at 4.6234 and consumer behavioural intentions of 4.5536. The average of the dependent variable is the consumer attitude towards digital shopping in Johor Bahru which is 4.5792. According to Hadiyanto and Suratno (2015) that the range of mean for both the independent variables and the dependent variable is 3.67-5.00, indicating a high degree of acceptability based on the replies from target respondents in this study. As a result, the mean result for each variable is designated as a good result.

Validity and Reliability Test

Table 4.4.1: Validity and Reliability Test

Variables	Cronbach's Alpha	Item	N (sample size)
Experience during digital shopping	0.799	5	384
Consumer Beliefs	0.868	5	384
Consumer Feelings	0.876	5	384
Consumer Behavioural Intentions	0.852	5	384
Consumer Attitude	0.863	5	384

The reliability test for dependent and independent variables can be seen in table 4.4.1 above. The Cronbach alpha coefficient value for the dependent variable, consumer attitude in Johor Bahru, was 0.863, indicating that it was good and dependable. The Cronbach alpha coefficient values for consumer beliefs, feelings, and behavioural intents variables were 0.868, 0.876, and 0.852, respectively, indicating that the reliability is good and dependable.

Pearson Correlation Analysis

Table 4.5.1: Pearson Correlation Analysis

Variables	Consumer Attitude	
Consumer Beliefs	Pearson Correlation	0.639**
	Sig. (2 - tailed)	0.000
	N	384
Consumer Feelings	Pearson Correlation	0.638**
	Sig. (2 - tailed)	0.000
	N	384
Consumer Behavioural Intentions	Pearson Correlation Sig. (2 - tailed)	0.715**
		0.000
	N	384

** . Correlation is significant at the 0.01 level (2-tailed)

From the table, there is good correlation between consumer beliefs and consumer attitude towards digital shopping in Johor Bahru ($r = 0.639$). There is also a good correlation between

consumer feelings and consumer attitude towards digital shopping in Johor Bahru ($r = 0.638$). Moreover, there is a good correlation between consumer behavioural intentions and consumer attitude towards digital shopping in Johor Bahru ($r = 0.715$).

Hypotheses Testing

Table 4.6.1: Summary of Hypotheses Testing

	Hypotheses	Statistical Analysis	Result
H1	There is a positive and significant relationship between consumer beliefs and consumer attitude towards digital shopping behaviour during Covid - 19.	0.639	Accepted
H2	There is a positive and significant relationship between consumer feelings and consumer attitude towards digital shopping behaviour during Covid - 19.	0.638	Accepted
H3	There is a positive and significant relationship between consumer behavioural intentions and consumer attitude towards digital shopping behaviour during Covid - 19.	0.715	Accepted

According to table 4.6.1, the three independent variables, namely consumer beliefs, feelings, and behavioural intentions, had good correlations with consumer attitudes towards digital shopping in Johor Bahru during the Covid-19 pandemic. In brief, following Pearson 's correlation testing, three hypotheses in this study were approved.

DISCUSSION

Consumer Beliefs

The H1 of objective 1 is to analyse the relationship between consumer beliefs and consumer attitudes toward digital shopping in Johor Bahru. Consumer beliefs have a positive correlation coefficient of 0.639, indicating a good correlation between consumer belief and consumer attitude. It's because consumer beliefs will have an impact on whether or not they use digital shopping during pandemic. According to Bina (2019), belief is the new advantage. Consumers are purchasing not the product itself, but rather the more significant concept that necessitates the purchase of that product. Consumers rely on their beliefs since they may have favourable or negative feelings about a product. According to Punj (2011), there is a substantial association between the opinion that online shopping aids in the selection of the best product fit and online purchase activity for customers who enjoy shopping. Consumers who are more concerned with the utility of their purchase are more likely to perform product research before making a purchase.

Consumer Feelings

Consumer feelings have a positive correlation coefficient of 0.638, indicating that there is a positive relationship between consumer feelings and consumer attitude. The H2 of Objective 2 is to decide whether or not the relationship between consumers' feelings and their attitudes towards digital shopping during Covid-19 is significant. In Johor Bahru, it was discovered that

consumer feelings have an impact on consumer attitudes regarding digital shopping. While positive emotions evoked after purchasing were highly related to satisfaction (Kunieda,2013). According to Jiang, Yang, and Jun (2013), the most main factor of online business success is consumer perceived online purchasing convenience. According to IGI (2021), consumers' sentiments regarding a brand, company, product, or service are evaluated using consumer feelings. It is used to identify consuming experiences and make an impression on the consumer.

Consumer behavioural intentions

The H3 of objective 3 is to determine the relationship between consumer behavioural intentions and consumer attitudes towards digital shopping in Johor Bahru during Covid-19 pandemic. Consumer behavioural intentions have a positive correlation coefficient of 0.715, indicating a good relationship between behaviours intents and attitudes. It shows that consumers' intentions have an impact on consumer attitudes towards digital shopping. According to Yulihisri, Aminul, and Ku Amir (2011), who performed research in Malaysia, attitude is one of the most important factors influencing university students' intention to shop online. Likewise, Jamil and Mat (2011) discovered that a favourable attitude toward online purchase intention preceded real internet buying. According to Fishbein, behavioural intention, which is regarded the primary antecedent of conduct behaviour, is influenced by the people's attitude toward the behaviour and the people's sense of social pressures, which is reflected by consumer attitude.

Limitations of the study

Researchers must consider various limits to this research when performing it. The researchers combined questionnaires from numerous historical surveys (depending on variables). The sample size and target group may not reflect all digital shoppers in Johor Bahru. Only a few consumers can be surveyed because this study is limited to Johor Bahru. The research sample size is limited to 384 respondents. While the previous survey's sample size was adequate to attain significant statistical capacity, it was insufficient enough to raise concerns about the possibility of generalization to a broader population. The limited sample of respondents may harm the study's precision and reliability. When assessing study findings, researchers were exposed to the challenge of using the Social Science Statistics Package (SPSS). Researchers have found it challenging to use this software since the Covid-19 pandemic, it takes a lot of internet data. The strength of an area's internet connection is dependent on it. Furthermore, researchers only attend SPSS seminar sessions online, making it difficult for them to understand the steps involved in using this SPSS application.

Recommendations/ suggestion for future research

The research focuses on studying more about the factors that impact consumer attitudes toward digital shopping during Covid-19. Other parties, such as researchers and retailers, can help the research by conducting similar studies in the future. This research may be useful to researchers in achieving their research goals by contributing as a reference. Aside from that, future researchers can use this research to expand this type of research into a more extensive scope of study and apply a different way to achieve their objectives.

Next, retailers can benefit from this research. Retailers can apply this research as a resource to improve the quality of their websites for their consumers, resulting in increased beliefs, feelings, behavioural intentions, and consumer attitude. Retailers also, can improve their service such as their new marketing plan, service quality, digital platform, etc. This can assist retailers in attracting consumers, increasing earnings, improving brand image, and

retaining existing consumer attitude.

CONCLUSION

The researchers studied consumer attitudes towards digital shopping in Johor Bahru during Covid-19. They found that the most crucial variables influencing consumer attitudes toward digital shopping is behavioural intentions. The study will act as a blueprint for consumers to better understand their attitudes about digital shopping.

REFERENCES

- Aw, S. B., Teh, B. T., Ling, G. H. T., Leng, P. C., Chan, W. H., & Ahmad, M. H. (2021). The covid-19 pandemic situation in malaysia: Lessons learned from the perspective of population density. *International journal of environmental research and public health*, 18(12), 6566.
- Bina, Jasmine. "Belief Is the New Benefit: Why You Need to Find Your Deeper Brand." Medium, 7 Feb. 2020, medium.com/swlh/belief-is-the-new-benefit-why-you-need-to-find-your-deeper-brand-75f7696b8924.
- "Consumer Beliefs - Consumer Behaviour - Lecture Slides - Docsity." [www.docsity.com](https://www.docsity.com/en/consumer-beliefs-consumer-behaviour-lecture-slides/246087/), www.docsity.com/en/consumer-beliefs-consumer-behaviour-lecture-slides/246087/.
- Cruz-Cárdenas, J., Zabelina, E., Guadalupe-Lanas, J., Palacio-Fierro, A., & Ramos-Galarza, C. (2021). COVID-19, consumer behavior, technology, and society: A literature review and bibliometric analysis. *Technological forecasting and social change*, 173, 121179.
- Currie, M. (2019, March 3). Definition of Consumer Attitude. Bizfluent. <https://bizfluent.com/about-6536655-definition-consumer-attitude.html>
- "Five Benefits of Online Shopping and Offline Shopping." Retail Minded, 14 Sept. 2020, retailminded.com/five-benefits-of-online-shopping-and-offline-shopping/#.YebtDP5Bzcd. Accessed 18 Jan. 2022.
- Hadiyanto, H., & Suratno, S. (2015). The practices of students' generic skills among economics students at National University of Indonesia. *Higher Education Studies*, 52-61.
- Jaiswal, Shefali, and Anurag Singh. "Influence of the Determinants of Online Customer Experience on Online Customer Satisfaction." *Paradigm*, vol. 24, no. 1, 28 May 2020, pp. 41–55, 10.1177/0971890720914121.
- Jiang, Ling (Alice), et al. "Measuring Consumer Perceptions of Online Shopping Convenience." *Journal of Service Management*, vol. 24, no. 2, 19 Apr. 2013, pp. 191–214, 10.1108/09564231311323962. Accessed 23 Sept. 2019.
- Khan, M. A., & Smith, J. E. M. (2020). "Covibesity," a new pandemic. *Obesity medicine*, 19, 100282.
- Kirchheimer, S. (2017, September 26). What is the Definition of Consumer Behavior? Bizfluent. <https://bizfluent.com/about-5162253-definition-consumer-behavior.html>
- Krejcie, R. V., & Morgan, D. W. (1970). Determining sample size for research activities. *Educational and psychological measurement*, 30(3), 607-610.
- LaMorte, Wayne. "The Theory of Planned Behavior." [Sphweb.bumc.bu.edu](https://sphweb.bumc.bu.edu/BostonUniversitySchoolofPublicHealth/9Sept2019/sphweb.bumc.bu.edu/otlt/MPH-Modules/SB/BehavioralChangeTheories/BehavioralChangeTheories3.html), Boston University School of Public Health, 9 Sept. 2019, sphweb.bumc.bu.edu/otlt/MPH-Modules/SB/BehavioralChangeTheories/BehavioralChangeTheories3.html.
- Popov, Andrey. "How COVID-19 Triggered the Digital and E-Commerce Turning Point | UNCTAD." [Unctad.org](https://unctad.org/news/how-covid-19-triggered-digital-and-e-commerce-turning-point), 15 Mar. 2021, unctad.org/news/how-covid-19-triggered-digital-and-e-commerce-turning-point.

- Punj, Girish. "Effect of Consumer Beliefs on Online Purchase Behavior: The Influence of Demographic Characteristics and Consumption Values." *Journal of Interactive Marketing*, vol. 25, no. 3, Aug. 2011, pp. 134–144, 10.1016/j.intmar.2011.04.004.
- "Retail Sales Growth Forecast 2022." Statista, www.statista.com/statistics/232347/forecast-of-global-retail-sales-growth/. Accessed 18 Jan. 2022.
- "The Digital Store: Transforming Retail in 10 Simple Steps • Detego." Detego, 16 Aug. 2019, www.detego.com/retail_insights_en/retail-en/from-store-to-digital-stage/.
- Yulia Vakulenko Poja Shams, D. H. K. H. (2018). Online retail experience and customer satisfaction: the mediating role of last mile delivery. *The International Review of Retail, Distribution and Consumer Research* 29(3), 306-320. doi:<https://doi.org/10.1080/09593969.2019.1598466>
- Yusta, Alicia Izquierdo, and Stephen J. Newell. "Consumer Beliefs and Motivations That Influence Repeat Online Purchases." *International Journal of Electronic Marketing and Retailing*, vol. 4, no. 4, 2011, p. 270, 10.1504/ijemr.2011.045611. Accessed 6 Sept. 2020.

Revolution 4.0: Re-understanding Humanity in the Era of Artificial Intelligence through an Analysis of Seyyed Hossein Nasr's Philosophy of Humanity

Musa Yusuf Owoyemi

*Department of Civilization and Philosophy, School of Languages, Civilization and Philosophy, College of Arts and Sciences, Universiti Utara Malaysia,
musayusuf@uum.edu.my & owoyemi2@yahoo.com*

ABSTRACT

This paper looks at the changing definition of human being through the traditional society to the renaissance/modern period and the 21st century. It bases this analysis on the dichotomy between the promethean and pontifical man as espoused in the thought of Seyyed Hossein Nasr and went on to define man anew based on the workings of AI robots in revolution 4.0. Using the qualitative method of critical analysis, it presented the understanding of man as pontifical and promethean as defined by Seyyed Hossein Nasr. Thereafter, it puts forward the argument that revolution 4.0 has disrupted our understanding of man in the present time as promethean and there is therefore a need for a new understanding of humanity as form, imagination and creative since reason, articulate speech and upright stand is no longer exclusive to him. Although, the paper suggested a definition, but it further affirms the need to rather return back to the definition and understanding of humanity as pontifical as Seyyed Hossein Nasr advised because this may be man's only saving grace in the face of constant disruption to what a human being is.

Keywords: *Artificial Intelligence, Humanity, Nasr, Revolution 4.0, Redefining, Robots*

INTRODUCTION

The Renaissance was a period of great change in Europe as it marks the eclipse of the traditional societies in that part of the world. It was a period in which, in addition to having encountered the Islamic civilization and got to know about how Muslim scholars had interacted with Greek philosophy, a lot of hitherto unknown manuscripts of ancient philosophers came into circulation and marks a reawakening in knowledge in Europe hence the term – Renaissance. This reawakening led to the estrangement of the Church from the scholars who specialises in science and philosophy as many of the beliefs propagated by the Christian Church came under serious attack from the scientists and philosophers of the time because they posit that these beliefs are questionable and they are not grounded in knowledge - rationalism and empirical evidence. Hence, this led to a lot of upheavals including the inquisition and the eventual break away of scientific knowledge, including philosophy, from religion as well as the breakaway of the state from the Church (the rise of secularism).

In view of the above, beliefs in the creation and origin of man as propagated by the Church came under scrutiny in science and philosophy and since these beliefs are not based on rational and empirical evidence, they were roundly rejected by scholars at that time. Thus, began the task of redefining and re-understanding man from the point of view of the new mode of knowing at that time – science and philosophy.

Although, the development of the theory of evolution preceded Charles Darwin, nonetheless, his idea as articulated in his book – *The Origin of Species by Means of Natural Selection* – provided a breakthrough for the scientists and the philosophers in their quest to redefine and re-understand humanity. With this theory that says that things evolved by means

of natural selection and survival of the fittest and were not created as previously understood in traditional societies, man came to be redefined and understood as an animal that evolved over a long period of time to become what he is today. In other words, man was not created by God; rather, he evolved from small biological specie to become *Homo sapiens* which is the highest of the other homos that evolved from this biological specie. Therefore, man was redefined in the Renaissance and the Enlightenment as “a man, woman, or child of the species *Homo sapiens*, distinguished from other animals by superior mental development, power of articulate speech, and upright stance” (Encyclopedia, encyclopedia.com). Thus, instead of saying man is a creation of God who has been imbued with knowledge to do the will of God on earth as preached by the Church and understood in traditional societies, he was redefined as a being that evolved over a long period of time and thus independent of God and the will of God. In other words, man evolved to *Homo sapiens* and thus could choose his purpose on earth on his own term without any reference to God or any divine being.

It was against this background and this new understanding of humanity in the Renaissance that Seyyed Hossein Nasr wrote his book *Religion and the Order of Nature* where he showcases how this new understanding of man has affected the relationship between man and God as well as between man and his environment (including other creatures in the environment). It is also in the light of this definition and understanding of man in the Renaissance through the Enlightenment to the modern period that I argued in what is to come below that even this definition of humanity which has prevailed from the time of the Renaissance has been disrupted by the development of Artificial Intelligence (AI) in Robots and it is in need of a revision. Moreover, while I provided what we could possibly piece together as the new definition of humanity in this revolution 4.0, I, nonetheless, argued that going back to the re-understanding of man as pontifical (as posited by Seyyed Hossein Nasr) may be our saving grace in this era of AI in robots.

A BRIEF REVIEW OF SOME OF NASR’S WRITINGS ON THE IDEA AND CONCEPTION OF HUMANITY

Seyyed Hossein Nasr is a scholar who has shown tremendous concern with the idea of man and his society, man’s conception of himself, his relation with the sacred and tradition (understood as religions) and his relation to other ontological entities in the universe. To put this in proper perspective, one can say that Nasr is a scholar who, like his Muslim contemporaries, sees the danger that modernism embodied and has been warning humanity about the catastrophe that is to befall man as a result of the adoption of the modern worldview. In other words, Nasr sees the change, idealism and philosophy heralded by modernism as the major problem of man in the contemporary time. He was among the very first scholar to warn about the danger inherent in the use of fossil fuel when it was first discovered. In his book, *The need for a sacred science*, Nasr highlights the problem of science and technology which is the driving force behind modernism and which unfortunately is devoid of the idea of the sacred. He analyses what that science and technology portend for humanity and his ontological status in the world. He condemned the modern view of science which changes the way man relates with the universe because this science sees the universe as a phenomena to be conquered, subjugated and exploited. This becomes possible because of the reinterpretation of the role of man as the master of the universe answerable to no one. In another of his work, *Traditional Islam in the modern world*, Nasr was able to catalogue the different dimensions of how the reinterpretation of humanity based on the modern worldview is affecting man and his society. Here, he explained the problematic conception of man “as a purely earthly creature and master of nature, who is responsible to no one but himself” (Owoyemi, 2011) and as a “being ‘free’

of heaven, complete master of his own destiny, earth-bound but also master of the earth, oblivious to all eschatological realities...”(Nasr, 1987; 103). In his other book, *Knowledge and the sacred*, Nasr explained how this conception of man affects human knowledge because instead of placing God at the centre of everything as was the case in Traditional societies, it removed God and placed man at the centre thus “man becomes the measure of all things”(Owoyemi, 2011 & Nasr, 1987; 100). This according to him laid the ground for the idea of the conquest of nature, its subjugation and exploitation by man. Furthermore, in his works entitled *The encounter of man and nature: the spiritual crisis of modern man* and *The spiritual and religious dimension of the environmental crisis* Nasr was able to put in view the environmental crisis that the conception of man in modern period has resulted into and typical of him, he not only highlighted these problems, he provided solutions to them which he hinges on the redefinition of man and his re-understanding of himself as not just a physical being but a spiritual being as well and a bridge between heaven and earth. In another of his work, *Islam and the plight of modern man*, Nasr explained how Islam could help man modern man to re-understand himself and his humanity as well as his role in the world in contrast to how he has been portrayed and made to live by modernism. Finally, in his work, *Religion and the Order of Nature*, Nasr took us back to the origin of the problem and critically analysed everything that is wrong with the reinterpretation of humanity that happened in the period of the Renaissance which heralded the birth of modernism. He pointed out that it was during this period that man starts to get it wrong and this culminated in modernism where man reached the point of no return as this led to the various problems that humanity is currently facing.

This work, *Religion and the Order of Nature*, will be the primary focus of this paper in what is to come below because it is here that we are able to have a full grasp of the changing conception of man from the traditional period to the present time.

NASR’S PHILOSOPHY OF HUMANITY AND THE CHANGING VIEW OF HUMANITY

According to Seyyed Hossein Nasr, prior to the period of the Renaissance, traditional societies east and west see man as pontifical – that is, a bridge between Heaven and earth. He posits that man was held as that which links the Heaven and earth together as he was seen as the khalifa/implementer of the WILL of Heaven on earth (Nasr, 1996: 163). In this sense, he says, man was a special being possessing both spiritual and material nature that adequately defines his duty as a vicegerent of God. However, with the advent of the Renaissance and the rise of the scientific revolution, this view of man changed drastically and Promethean man became the order of the day. By Promethean, Nasr meant that man removed God from the centre of his universe and replaced God with himself as “*the be*” all and decider of everything on earth (Nasr, 1996: 163). In other words, man cuts himself off from Heaven and sees the earth as his domain to be conquered and subjugated to his will and not the Will of Heaven. He points out that, with the scientific revolution, man seeks total dominion over the earth on his own terms without reference to the WILL of Heaven (Nasr, 1996: 126 - 162). To further solidify this new humanism, Nasr explains, in *Knowledge and the Sacred*, that in the modern period, human rationalism becomes the almighty determinant of all things in human society. To be human, you have to be rationally independent from all knowledge, beliefs, dogmas and superstitions espoused by the traditional society. Man’s humanity came to be defined based on his ability to reason especially without the aid of faith (Nasr, 1989: 160). Thus, Nasr says, this led to a situation in which what is known as a human being changed drastically and this change not only affected how he looks at himself but how he also looks at his environment and other creatures in it. This promethean view of man, he posits, led to the environmental crisis that we

are currently experiencing and this is not going to change until this view of man is abandoned altogether.

However, despite Nasr's warning, this trend continues until the post-modern period when rationalism itself was challenged as being inadequate in determining man and his society. The post-modernist see the reduction of everything to rationalism as too narrow and are in fact sceptical about its claim to authority over other forms of narratives. In other words, post-modernism removed man from the centre of everything but instead of returning back to the concept of pontifical man as Nasr had canvassed for, it accepted that anything could be placed at the centre and not necessarily God as in traditional society. Thus, man is not the lord and emperor of everything as previously thought but neither is God reckoned with in this new worldview. This period marks a situation in which, while the definition of man remains what it was during the Renaissance to the modern period, his major description as having superior rationality to tackle all problems becomes questionable and unacceptable. Scepticism, subjectivism and relativism become the order of the day and man was left without a direction. This new understanding sees man as a wanderer without any particular direction.

In the late 20th century to early 21st century, with the advent of the computer, internet, and other information technology tools, the idea of man and his society also changed drastically especially with the rise of the idea of globalization. In this period, man was no longer defined within his small enclave as a being in communion with his immediate environment; he became a global citizen with interest far and wide beyond his physical boundaries. He became a global man not defined by his immediate environment but by what and who he is able to connect with globally while remaining in his abode physically.

Furthermore, this issue has become complicated in the contemporary time with the advent of Artificial Intelligence (AI) and its use in robot building. The definition of man is again being called into question as these robots are as efficient, articulate and intelligent as man if not more than man. Thus, in the face of this new development, what is a human being? This question becomes necessary because if AI robot is akin to a human being, there has to be something which will differentiate man from AI robot.

RE-UNDERSTANDING A HUMAN BEING IN THE ERA OF AI

As asserted above, according to Nasr, in traditional societies, a human being is understood to be a pontifical being who is define severally as an image of God¹ or a vicegerent of God² or as a part of God³ or as a sentient being capable of attaining to enlightenment which means his ascent back to Heaven or the Divine⁴. In all these definitions, what is apparent is the fact of man's tie to Heaven or the Divine. With this understanding man was seen in the traditional societies as a bridge between heaven and earth. In fact to expound this further in the Abrahamic religions (Judaism, Christianity and Islam) man's life on earth is for a short time, and his final abode is heaven or hell according to his deeds on earth. After man's death, he will be brought back to life on a day called a Day of Judgment and on that day, he will give account of his stewardship on earth. If he was able to serve God, as he has been commanded to do, and carried out his duties sincerely in his relationship with his fellow men and everything in his

¹ This is the Christian understanding of man as someone that is created in the image of God

² This refers to the Muslim understanding of man as a person created to be an ambassador/vicegerent (Khalifah) of God in the world

³ This refers to the Hindu understanding of man as part and parcel of god which is called pantheism

⁴ This refers to the concept of man in Buddhism

environment pleasing God, he will be admitted to paradise where he will live forever. On the other hand, if he failed in his worship of God and in his relationship with his fellow men and other things in his environment, he will be punished in Hellfire where he will live for some time or forever based on the extent of his failure on earth and whether he has any belief about the existence of God (see Abdul Latif, 2002: 74–96; Nomani, 1978: 80–100; Rahman, 1999: 106–120).

However, from the time of the Renaissance through to the modern period, as Nasr explains, this concept of man in the traditional societies was put to serious test and undergoes a radical change as a result of the different revolutions in human society that started with the Renaissance. Likewise, the revolt of the scientists and philosophers against the Church from the period of the Renaissance to the modern period also calls for a situation in which everything, humans, society, the cosmos etc. has to be redefined in the face of this new change because the Church that had hitherto defined all things from the perspective of religion has been rejected (Nasr, 1996: 163–190). There was therefore a need to redefine and re-understand things anew in the light of the change in worldview.

Thus, in the light of the above, since the seventeenth century when men became ‘enlightened’ and rejected the traditional definition of man, which is based on revelation, modern man has been grappling with the problem of redefining man and tracing his origin (and the origin of the universe) since, to the modern thinkers, the creationist story of religion does not make ‘sense’ and cannot stand the test of ‘reason’ and empirical evidence.

However, in 1859, Charles Darwin provided modern man with the evolutionary theory in which he postulates that man evolved from lower animals to higher animal through the process of natural selection and survival of the fittest (see Darwin, 1993 & Harris, 1988). Thus, through this theory, modern man has since held on to the view that the origin of man lies in evolution through natural selection⁵ and with this understanding man was seen as an independent being who has developed or evolved a process of thought (reason) naturally and thus, he should be defined in accordance with his ability to think. Baron d’Holbach, one of the modern thinkers, says, concerning the use of reason by human being: “The *enlightened man*, is man in his maturity, in his perfection; who is capable of pursuing his own happiness; because he has learned *to examine, to think for himself*, and not to take that for truth upon the authority of others, which experience has taught him examination will frequently prove erroneous...” (Sherman, 2000: 136). Likewise, Thomas Paine advocated the need to reject traditional institutions and to use reason to decide what is true or false for oneself: “*My own mind is my own church*. All national institutions of churches, whether Jewish, Christian, or Turkish, appear

⁵ Duane T. Gish, a biologist, made the following statement concerning this theory: “there is actually a considerable body of sound, scientific evidence that contradicts the theory of evolution, some of which appears to be absolutely incompatible with the theory. The importance of the nature of this evidence is never emphasized in textbooks used in our public school systems and colleges. In fact, this evidence is rarely, if ever, even mentioned. As a result, biology students are exposed to all the evidence that can be adduced in favour of the theory, but are not made aware of its weaknesses, nor the evidence that actually contradicts the theory. We must recognized, therefore, that such an educational process amounts to indoctrination in a particular worldview or philosophy based on the concept that the origin of the Universe, the origin and diversity of life, in fact all of reality, must be explained solely on the basis of the laws of chemistry and physics. The possibility of a Creator or the existence of a Supernatural Being is excluded. We are convinced that the reason evolutionary theory is so widely accepted today is because our scientists and biology teachers are the products of an educational system dominated by this naturalistic, mechanistic, humanistic philosophy.” Quoted from Gish, Duane T., “Creationism versus Evolution” in *Philosophy of Religion: An Anthology*, edited by Louis P. Pojman, (Canada: Wadsworth/Thomson Learning, 2003), p. 456.

to me no other than human inventions set up to terrify and enslave mankind, and monopolize power and profit” (Sherman, 2000: 142-143).

In the light of this rejection of the traditional definition of man and the rise of ‘reason’, human being came to be defined as “a man, woman, or child of the species *Homo sapiens*, distinguished from other animals by superior mental development, power of articulate speech, and upright stance” (Encyclopedia, encyclopedia.com). To put it succinctly, a human being means a perceiving person who could reason, produce articulated speech and stand upright. Although, this definition could be problematic and in fact it has given rise to a lot of questions in the field of philosophy because of its limiting criteria of what human beings are? Fundamentally philosophers have asked questions such as whether those who are incapable of reasoning, lack the ability to articulate speech or are notable to stand upright because of deformity are human beings or not (Pojman, 1999: 146–149). These questions have not being satisfactorily answered by philosophers till the contemporary time. Thus, with the rise of AI in robots and machines, these questions have become more complicated and this definition of human being is even more problematic now because AI robots are able to reason, produce articulate speech and walk erect like human beings.

However, one of the solutions to these questions is that provided by Aristotle with his idea of potentiality and actuality. According to him, humans have the ability to reason, speak and stand erect potentially and not actually. Thus, it means that these qualities are held by man potentially and he may actualise them or may not actualise them (Stumpf & Fieser, 2012: 77–79). But, when we talk about a human being, he says, we know him by his *form*. According to him, we necessarily recognise the *form* of a human being when we see one and this form differentiates him from other creatures. In the words of Plato, we know this form of the perfect human being in the World of Forms before we are created into this world which is a carbon copy of the world of forms. Thus, according to Plato, we recollect the form of the perfect human being when we see any humans and we are thus able to identify the person as a human being because he partook in the form of the perfect human being who is in the world of forms (Stumpf & Fieser, 2012: 49–52).

The idea of *the form* according to Plato holds that everything has a perfect form which exists in the world of forms. Thus, everything on earth is a replica of that perfect form which is in the world of the forms (a world that is said to be totally different from this world but whose location we do not know and Plato could not explain). Although, there are many questions and arguments against this idea especially as raised by Aristotle, nonetheless, we seems to be left with no option other than to accept this as viable because this will make it possible to admit everyone that shares the human form into the fold of humanity whether sane or insane, properly formed or deformed, articulate or inarticulate. Moreover, as pointed out above, Aristotle himself eventually accepted the idea of the form though with a different explanation from Plato as he posits that things exist with their form in this world and we recognise them when we see them. Consequently, he avers that there is no world of the form somewhere else as Plato posited (Stumpf & Fieser, 2012: 49–52 & 75–76).

Fundamentally, whichever of these explanations of the form that one subscribes to, what is important is that irrespectively of whether a person can use his reason or not, can articulate his speech or not, stand erect or not, we can know that such a person is a human being because of the *form*.

Therefore, if reason, articulate speech and upright movement are no longer exclusive to human being because robots can also do these things, it means that we have to redefine what a human being is and in this case, we can start by saying that he is simple a homo sapiens who has a different *form* which distinct him from other creatures as Plato and Aristotle posited above. In other words, our *form* is the only thing that defines us and not superior intelligence and articulate speech as we had previously believed. This is true because it has even been predicted that AI in robots, automated machines and computers may eventually outsmart us in terms of superior thinking and intelligence. Therefore, we can no longer claim that the domain of reason belongs exclusively to human beings and it is either we subscribe to the fact that we are simply homo sapiens and it is only our *form* that defines us or we accept back the traditional definition of man as pontifical – a link between heaven and earth – and, purely, a vicegerent of God on earth which is a quality that will set us apart from all other things and beings as Nasr posits.

Nonetheless, if what remains of the definition of man a promethean human being in the light of AI robot is the form, we can still argue that humans possess two more things that are still beyond the reach of AI robots and these are *imagination* and *creativity*. While thinking is linear in nature, the power of imagination is beyond prediction and thus beyond the thinking of a robot. Even though an AI robot may be able to predict certain things about the behaviour of man based on his pattern of doing certain actions frequently, there is no denying the fact that human has the capacity to change abruptly based on his imagination which sometimes defies logic. In other words, humans have the ability to be irrational and behave irrationally which is something a robot lacks the ability to do. It is this power of irrationality that also speaks to man's ability to be creative. This is because creativity is essentially irrationality as it is something that defies the norms. A human being is one of the most unpredictable being on the surface of the earth and this is due to other factors than rationality (factors which to my mind are imagination and creativity). The power of human imagination which leads to creativity could make rationality useless and this may be an area in which humans will be able to surpass AI robots. If, therefore, imagination and creativity are things that are peculiar to man, it is pertinent that in this age of disruption, it is something which may better define a human being. In the light of this, we could conclude that in addition to the *form* of man, man also has imagination and creativity as part of his definition and thus, we could redefine a human being as “a man/woman with the *form* of homo sapiens who has the power of *imagination* and *creativity* and shares the ability to perceive, think and walk erect with AI robots.” In other words, three important elements that differentiate man from AI robots are: *form*, *imagination* and *creativity*.

The downside to the above is also the fact that like Aristotle posited on reason, articulation and walking erect, humans has these two things potentially and not actually. It is possible that some may not be able to use their imagination and creativity whether they are aware of them possessing them or not. Thus, *form* seems to be the only thing that is actual and constant in man.

However, in spite of this new definition and understanding of humanity, on a sober note, it is important to point out that this journey that humanity is embarking on in revolution 4.0 could spell doom for human beings just as previous revolutions has resulted in man losing himself as a directionless being coupled with the attendant environmental disaster that is currently plaguing the world. Many scholars have warned that AI robots if not carefully handled could spell the doom of humans and some have even predicted that we are creating specie of being that will eventually replace us. Great as this tool (AI robot) is, we should not

lose sight of the fact that there is the potential of some human going rogue with its use and we could even turn them on ourselves thereby causing self-implosion. In our quest to use this tool for our comfort, it is better if we accept and go back to our definition of human beings in the traditional society as pontifical being so that our use of this tool will be guided by the Will of Heaven and not the Will of promethean man. As Louis Pojman pointed out in his ethics, something which is anchor on the power of a divine authority has a lot of meaning for man than something which is not anchor on any authority and could be used for anything as a person deems fit (see Pojman, 1999: 202–205). The warning of Seyyed Hossein Nasr which was relevant as at the time that man was just discovering the fossil fuel and redefining himself in the light of the rapid changes at that time is still very much relevant in the contemporary time where new changings are occurring on an alarming note because of the use of AI. Pontificalism as defined by Nasr is the way for us to go and it is the solution to the problems that we are facing now and will face in the future. Our redefinition as *form, imagination* and *creativity* as an edge against the rationalism of AI robot will not deliver us from the perils that we are going to put ourselves into except, in addition to these things, we subject ourselves to the Will of Heaven as in traditional societies while discarding therein⁶ things that contradict what we know to be true based on objective knowledge. If the Will of Heaven guides human use of AI technology, the potentially to use it in a destructive way will be minimal and in fact could be curbed through a joint action of the international community.

CONCLUSION

In this brief analysis, this paper looked at the definition of human beings in the traditional society and how this definition changes and continue to change as humans move along in his history. It pointed out how Seyyed Hossein Nasr sees the definition of man in the traditional society as the real concept of man and explained how he warned against discarding this concept as man move on in his historical journey. According to him, man will continue to create problem for himself as long as he does not return to his origin of being a Pontifical being wherein his destiny and the fate of his society lies. With the advent of revolution 4.0 and the use of AI, the definition and understanding of man has again changed from being the only rational being to being *form, imagination* and *creativity*. However, based on what Nasr explained, these in themselves will not be enough to solve the problem of man and take him out of the conundrums that he has put himself and other things on earth. To arrive at a comprehensive solution, man has to reconnect himself to heaven by going back to being the pontifical being that he was intended to be.

REFERENCES

- Abdul Latif, S. (2002). *The mind Al-Quran builds*. Kuala Lumpur: Islamic Book Trust.
- Darwin, C. (1993) *On the Origin Of Species by Means of Natural Selection, or the Preservation of Favoured Races in the Struggle for Life*. New York: Random House Modern Library.
- Gish, Duane T. (2003). "Creationism versus Evolution" in Louis P. Pojman, ed. *Philosophy of Religion: An Anthology*. Canada: Wadsworth/Thomson Learning.
- Harris, M. (1988). *Culture, People, Nature: An Introduction To General Anthropology*, 5th edn. New York: Harper & Row Publishers.
- Encyclopedia. *Human Being*. Oxford University Press. encyclopedia.com accessed August 30, 2021.

⁶ By this we mean leaving out things that are based on mere superstition and not grounded in knowledge especially those things that are physical and can be examined based on rationalism and empiricism. This does not include spiritual things which are beyond the purview of man and can only be known by revelation.

- Nasr, S. H. (1989). *Knowledge and the Sacred*. New York: State University of New York Press.
- Nasr, S. H. (1996). *Religion and the Order of Nature*. New York: Oxford University Press.
- Nasr, S. H. (1968/1986). *The encounter of man and nature: the spiritual crisis of modern man*. Kuala Lumpur: Foundation for Traditional Studies.
- Nasr, S. H. (2002). *Islam and the plight of modern man*. Cambridge: The Islamic Texts Society.
- Nasr, S. H. (1987). *Traditional Islam in the modern world*. London and New York: Kegan Paul International.
- Nasr, S. H. (1993). *The need for a sacred science*. New York: State University of New York Press.
- Nasr, S. H. (1999). *The spiritual and religious dimension of the environmental crisis*. London: Temenos Academy.
- Nomani, M. M. (1978). *The Quran and you* (2nd edn.). (Mohammad Asif Kidwai trans.). Lucknow, India: Academy of Islamic Research and Publication.
- Pojman, L. (1999). *Ethics: Discovering Right and Wrong*. USA: Wadsworth Publishing Company.
- Preston, N. (2007). *Understanding Ethics*, 3rd edn. Sydney: The Federation Press.
- Rahman, F. (1999). *Major themes of the Quran*. Petaling Jaya: Islamic Book Trust.
- Sherman, D. (2000). *Western Civilization: Sources, Images, and Interpretations*, 3rd edn. Boston, U.S.A: McGraw Hill Companies Inc.
- Stumpf, S. E. & Fieser, J. (2012). *Philosophy: History and Readings*, 8th edn. New York: McGraw Hill Companies, Inc.

The Relationship Between Physical Activities and Sleeping Quality During COVID-19 Among Students in Kolej Komuniti Pasir Mas

Aisha Azman

University Malaysia Kelantan
aisha.h18b0814@siswa.umk.edu.my

Azman Bidin

University Malaysia Kelantan
azman.bidin@umk.edu.my

Maziha Mustafa

Kolej Komuniti Pasir Mas
maziha@kkpmas.edu.my

ABSTRAK

COVID-19 bermula di Malaysia pada Mac 2020 selepas merebak ke seluruh dunia pada Disember 2019. Akibatnya, perintah berkurung atau perintah kawalan pergerakan (PKP) telah diwujudkan di seluruh dunia untuk memerangi penyakit ini. Rutin harian PKP telah berubah, terutamanya dalam tingkah laku yang tidak aktif, membayangkan perubahan dalam hubungan antara aktiviti fizikal dan corak tidur semasa wabak COVID-19. Matlamat kajian ini adalah untuk lebih memahami interaksi antara aktiviti fizikal dan tidur semasa wabak COVID-19. Kajian ini mengumpul data kuantitatif daripada 294 responden. Soal selidik digunakan untuk mengumpul data, yang kemudiannya dianalisis menggunakan SPSS versi 26. Hasil dapatan kajian ini menunjukkan berlaku perubahan dalam corak tidur pelajar semasa COVID-19 akibat dari pengurangan aktiviti fizikal. Kajian ini menggunakan pendekatan penyelidikan kuantitatif untuk mendapatkan data dan maklumat yang diperlukan untuk penyelidikan ini, dan data dikumpulkan daripada 52 responden melalui kaji selidik internet menggunakan soal selidik tertentu. Menurut dapatan kajian, terdapat hubungan yang kuat dan positif antara jurang antara Aktiviti Fizikal dan Corak Tidur di kalangan pelajar. Tambahan pula, penyelidikan masa depan perlu mendapatkan saiz sampel yang luas termasuk universiti Kelantan yang lain, yang penting untuk kajian masa depan mengenai gaya hidup pelajar atau psikologi.

Kata kunci: Aktiviti Fizikal, Corak Tidur, COVID-19

ABSTRACT

COVID-19 started in Malaysia in March 2020 after spreading over the world in December 2019. As a result, a lockdown or movement control order (MCO) has been established globally to combat the illness. MCO's daily routine has changed, particularly in sedentary behaviours, implying alterations in the relationship between physical activity and sleep patterns during the COVID-19 epidemic. The goal of this research is to better understand the interaction between physical activity and sleeping during COVID-19. This study collected quantitative data from 294 respondents. A questionnaire was used to gather data, which was then analysed using SPSS version 26. To summarize, the study's results were obtained and supported the study's variable. The results of this study show that there are changes in students' sleep patterns during COVID-19 due to reduced physical activities. This study used the quantitative research approach to obtain the data and information needed for this research, and the data were collected from 52 respondents via an internet survey using a particular questionnaire. According to the findings of the study, there is a strong and positive association between the gap between Physical Activities and Sleeping Patterns among students. Furthermore, the

future researcher should get a wide sample size that includes other Kelantan universities, which is vital for future study on student lifestyle or psychology.

Keywords: *Physical Activity, Sleeping Patterns, COVID-19*

INTRODUCTION

Sleep is a natural state of mind and body that is characterised by altered awareness, suppressed sensory activity, decreased muscular activity, and the prevention of virtually all involuntary muscles during Rapid Eye Movement (REM), as well as reduced engagement with the environment. Based on such sleep, may identify an individual's sleep habits. According to Powell and Hawes (2020), a sleep pattern, also known as a sleep-wake pattern, is a biological rhythm that informs the body when to sleep and when to begin waking up. It is one of the body's circadian rhythms, and it normally operates on a 24-hour cycle, controlling the body's rest (sleep) and waking schedule.

Sleeping habits may also be assessed in many ways. The technique of measurement that can assess sleep patterns with the simplest and quickest findings is what distinguishes it. This pattern, contrary to popular belief, has its process. Suni (2021) defines sleep as a complicated process that impacts every area of the body. It is visible during a range of sleep stages, including light sleep (stages 1 and 2), deep sleep (stage 3), and rapid eye movement (REM) sleep. When sleep cycles through all these sleep stage many times every night, it can serve its crucial function of revitalising human bodies and brains. As a result, sleep is an essential component for ensuring that the body's systems, including the neurological system, respiratory system, digestive system, and others, may be refreshed and recharged.

There are also many perspectives on sleep patterns. According to Powell and Hawes (2020), a sleep pattern, also known as a sleep-wake pattern, is a biological rhythm that informs the body when to sleep and when to begin waking up. It is one of the body's circadian rhythms, and it normally operates on a 24-hour cycle, controlling the body's rest (sleep) and waking schedule.

There have been few studies on the quality of sleep among university students during the covid-19 breakdown until now (Zuki et al., 2021). Some pupils participated in the survey. The rates of excellent and bad sleepers based on the worldwide PSQI score A worldwide PSQI score of >5 showed that 57.3 percent of pupils had poor sleep quality. University students' sleep habits have been disrupted because of the covid-19 epidemic. The consequences of sleep patterns can be both positive and negative. Based on the data, students can comprehend or modify their sleep habits.

According to Zhou et al. (2020), there was a significant prevalence of sleep disorders among teenagers and young adults in China throughout part of the covid-19 pandemic, particularly among senior high school and college students, which was adversely related to the level projection in covid-19 trends. They also observed that social support might alleviate or reduce insomnia symptoms by lowering anxiety and depression symptoms, therefore during the covid-19 epidemic, parents, school organisations, and other groups should give some social support to teens and young people. These findings also suggest that the government should focus more on sleep-related concerns. These findings also suggest that the government should pay greater attention to sleep problems among teens in the fight against covid-19.

SLEEPING QUALITY

According to Suni (2020), Sleep quantity and quality are not the same things. Sleep quantity is the amount of sleep you receive each night, but sleep quality is how well you sleep. Measuring sleep quantity is straightforward since determining if you're receiving the appropriate amount of sleep every night is quick (usually defined as 7-9 hours for adults). Sleep quality measurement is more of an art than a science.

Sleep quality is also crucial in promoting health since studies over the last decade have shown that sleep disruption has a substantial effect on the risk of medical disorders such as cardiovascular disease and cancer, as well as the occurrence of depression. Even though the word "sleep quality" is often used in sleep medicine, it has not been fully defined. The National Sleep Foundation (NSF) presented the primary predictors of quality sleep among healthy persons (sleep latency, frequency of awakenings >5 minutes, wake after sleep initiation, and sleep efficiency) without considering sleep architecture or nap-related characteristics.

In addition, previous research found that the meaning of sleep quality in people with insomnia and normal sleepers was roughly similar when comparing people with and without insomnia, given that poor sleep quality is a prominent component of insomnia. Nonetheless, the NSF characterized the major indications of excellent sleep quality as sleeping more time in bed (at least 85% of total time), falling asleep in 30 minutes or less, waking up no more than once each night, and being up for 20 minutes or less after falling asleep (Wang & Boros, 2019).

PHYSICAL ACTIVITIES

Physical exercise is a key factor in determining a person's life. This is critical for lowering the risk of chronic diseases such as coronary heart disease, renal failure, and others. Physical activity includes not only exercise but also any bodily motions associated with energy consumption. According to WHO (2020), an adult between the ages of 18 and 64 must engage in moderate physical activity for at least 150 to 300 minutes per week, or 30 minutes per day. Meanwhile, a person should engage in 75 to 150 minutes of strenuous intensity activity each week.

Physical activities include any movement, whether it is for recreation, transportation to and from locations, or as part of a person's job, and can be of moderate or high intensity (WHO, 2020). According to the US Department of Health and Human Services Physical Activity Guidelines for Americans, anything that causes the heart to beat quicker is considered moderate activity (Bumgardner, 2021).

According to Prosch (2018), moderate exercise includes activities that use more oxygen, such as brisk walking, walking to class or work, cleaning or mopping the floor, and playing tennis or hoops. Meanwhile, strong-intensity physical exercise is a form of physical activity that is associated with quick breathing and a high heart rate since it demands the most oxygen. Running, swimming, jumping rope, and other activities fall into this category.

RELATIONSHIP BETWEEN PHYSICAL ACTIVITY AND SLEEPING PATTERNS

The Covid-19 epidemic has abruptly altered people's routines, necessitating the implementation of new norms like house confinement and online distance schooling. All these

changes have an impact on a student's life in terms of time management, learning styles, and activities. Along with it, there are modifications in a student's everyday physical activity.

During the epidemic, most students used online learning methods, which eliminated the need for students to attend physical classes. As a result, moderate physical activity has been reduced among undergraduate students, affecting their everyday activities. Lack of physical exercise relates to sleeping patterns during a pandemic because outdoor activities such as a park, courts, and indoor activities such as gyms have been restricted (Sañudo et al., 2020). Not only that, but a lack of physical exercise is linked to psychological issues such as mental health, well-being, and lifestyle habits such as sleep patterns.

According to some research, they have been discovered that BMI influences the connection between insufficient physical activity levels and sleep quality. Obesity is a risk factor for sleep problems in and of itself. Weight increase over time is a risk factor for developing a variety of sleep difficulties and daytime drowsiness. However, reducing physical activity levels during the COVID-19 epidemic increased the risks of decreasing sleep quality by 1.5 times regardless of covariates such as BMI, demonstrating the need of maintaining physical exercise practice throughout this outbreak (Diniz et al., 2020).

Previous research has also demonstrated that physical exercise has a good influence on sleep quality, and it is regarded as one of the non-pharmacological therapies to enhance sleep quality (Banno et al., 2018). However, the inquiry into physical activity level and sleep pattern are still underway, and there is no adequate proof of the effect of the least physical activity due to covid-19 condition that might contribute to the sleep pattern, which is sleep quality (Diniz et al., 2020).

METHOD

In this study, a quantitative research approach has been used by the researcher. This research uses quantitative methods to obtain numerical data from respondents, including the use of a questionnaire that contains questions on the independent and dependent variables. Quantitative research necessitates the collection and analysis of data to discover patterns, and averages, make predictions, establish causal linkages, and generalise conclusions to larger groups (Bhandari, 2020). This study collects data and information about students' physical activities and sleeping qualities in KKPM during the COVID-19 crisis from the respondents. The researcher collects data by sending questionnaires to respondents from specific online questionnaire forms of Google Forms.

Population and Sampling

This study's target population is Kolej Komuniti students in Pasir Mas. Based on the Department of Statistics, Malaysia 2021, and the Krejcie and Morgan sample schedule (1970), the total number of students in Selangor in this study is 60. This study has established a total of 52 respondents to answer the questionnaire. To acquire data, convenience sampling was chosen. Convenience sampling is a type of nonprobability sampling. In this study, the researcher selected convenience sampling to collect data since it is rapid, easy, and less costly.

Research Instrument Development

A systematic questionnaire was utilised to analyse students' physical activities and sleeping quality among KKPM during the Covid19 crisis. All the statements in the questionnaire were written in both English and Malay. The questionnaire is divided into three sections: Section A, Section B, and Section C. Section A discuss the respondents' demographics, such as gender, age, enterprise size, and established time. Sections B and C will be dedicated to the study and assessment of physical activity and sleep quality. The 5-Point Likert scale was utilized in Sections B and C of the questionnaire for this investigation. Respondents must choose on a scale ranging from 1 - "10 minutes or less" to 5 - "50 minutes or more."

DATA ANALYSIS AND FINDINGS

Pilot Study

Pilot studies are often carried out to assess the viability of approaches, procedures, questionnaires, and interviews, as well as how they interact in each environment (Fraser et al., 2018). As a result, a set of questionnaires has been issued to KKKM students for pilot testing. This is because the pilot study findings can assist researchers in identifying design faults and improving data collection before beginning expected future investigations and resolving these issues in advance (Fraser et al., 2018). Based on the comments of the target respondents, the researcher will enhance the quality of the questions in the questionnaire.

Table 1: Reliability Statistics for Pilot Test

VARIABLES	CRONBACH' SALPHA	NUMBER OF ITEMS	TOTAL RESPONDENT
Physical Activity	0.814	9	52
Sleeping Quality	0.802	7	52

Descriptive Analysis

The researcher used IBM SPSS Statistics Version 7 to evaluate the acquired data into mean and standard deviation. The central tendency measurement is provided in the tables below.

Demographic Profile

Table 2: Demographic Profile of Respondents

GENDER / JANTINA

	Frequency	Percent	Valid Percent	Cumulative Percent
Valid	53	100.0	100.0	100.0

CLASS / KELAS

	Frequency	Percent	Valid Percent	Cumulative Percent
Valid	53	100.0	100.0	100.0

RACE / BANGSA

	Frequency	Percent	Valid Percent	Cumulative Percent
Valid	53	100.0	100.0	100.0

NATIONALITY / WARGANEGARA

	Frequency	Percent	Valid Percent	Cumulative Percent
Valid	53	100.0	100.0	100.0

MARITAL STATUS / STATUS PERKAHWINAN

	Frequency	Percent	Valid Percent	Cumulative Percent
Valid	53	100.0	100.0	100.0

Table 2 displays the demographic profile results. All the frequencies are the same, which is 53. The percentage, valid percentage, and cumulative percentage are all equal to 100. All the respondents are Malaysians, and all are Muslims.

Physical Activity

Table 3: Descriptive Analysis of Physical Activities

Descriptive Statistics

	N	Minimum	Maximum	Mean	Std. Deviation
1. Question 1	53	1	5	2.47	1.067
2. Question 2	53	1	5	2.62	1.113
3. Question 3	53	1	5	2.83	1.312
4. Question 4	53	1	5	2.68	1.088
5. Question 5	53	1	5	3.17	1.355
6. Question 6	53	1	5	2.74	1.059
7. Question 7	53	1	5	2.94	1.231
Valid N (listwise)	53				

Table 3 shows the frequency, mean, and standard deviation for each item in physical activity. There was a total of seven (7) questions to be answered. According to the results, question 5 has the highest mean (M=3.17). The second highest score is on question 7 (M=2.94). Meanwhile, the mean for question 3 was 2.83 with a standard deviation of 1.312. The next question has a mean of 2.74. Question 4 (M=2.68 with a standard deviation of 1.088). The answer to question 2 revealed that the Mean is 2.62. Furthermore, the answer to the last question is less than 2.50.

Sleeping Quality

Table 4: Descriptive Analysis for Physical Activities

Descriptive Statistics

	N	Minimum	Maximum	Mean	Std. Deviation
1. Question 1	53	1	5	3.08	1.238
2. Question 2	53	1	5	2.79	1.364
3. Question 3	53	1	4	2.47	.992
4. Question 4	52	1	5	2.71	1.304

5. Question 5	53	1	5	3.08	1.342
6. Question 6	53	1	5	2.66	1.329
7. Question 7	52	1	5	2.62	1.191
8. Question 8	53	1	5	2.53	1.187
9. Question 9	53	1	5	2.13	1.287
Valid N (listwise)	51				

Based on the table above, questions 1 and 5 have the same mean result, which is 3.08. Question 2 has the second highest mean of 2.79, and question 4 has the lowest mean of 2.71. Next, questions 6 and 7 have a mean level of 2.60. Furthermore, the mean on question number 8 is 2.53 with a standard deviation of 1.187. Finally, the mean for the remaining two questions is less than 2.50, as seen in table 4.

DISCUSSION AND CONCLUSION

Recapitulation Of Findings

This section will go over the study's findings. The findings of this study concentrated on the study's research aim and research issue. The primary goal of this study is to determine the association between physical activities and sleeping patterns (quality) among students at Kolej Komuniti Pasir Mas during COVID-19.

The sample size was determined using the approach proposed by Krejcie and Morgan (1970), and the sample size is 52 respondents. In this study, the online questionnaire is distributed to 52 respondents over three days. This study's respondents are all students of KK Pasir Mas. The respondents are divided into four classes: SPP1A (15), SPP1B (13), SPP3A (16), and SPP3B (16). This study's principal instrument for collecting numerical respondent data is quantitative. Based on the data obtained, the descriptive analysis result is based on the online questionnaire prepared by the researcher using Google Forms. The total number of questions in sections A through C in the questionnaire is 21.

Limitations of The Study

Respondent participation was one of the study's weaknesses. Because some respondents declined to answer the questionnaire, the data-collecting procedure became delayed. Furthermore, the study's restriction, the constraint experienced in conducting this study, is a dearth of research on the subject or the issue because it is connected to Covid-19. The worldwide Covid-19 epidemic has prompted exceptional research. This epic pandemic has emphasised the impact of continuous research during an epidemic, the relevance and limitations of real-time epidemic research, the importance of the physician workforce, and many other issues. One of the constraints we must encounter while using MCO is the delay in data-collecting tasks.

Not all the material in this study can be utilised as a reference for future researchers. This is since this study and its questionnaire are especially focused on the deployment of MCO in Covid-19. As a result, respondents' responses to the survey were solely dependent on their participation in MCO. Furthermore, because the questionnaire was administered online, not all information was available, such as the respondent's BMI, which was computed using weight and height measurements. If data is obtained in person, another way to assess physical activity and smartphone usage will be used, such as an application or others. However, to minimise and diminish Covid-19 instances, researchers used an online questionnaire approach.

RECOMMENDATIONS AND SUMMARY

Based on the data, the proposed guideline for the study approach is Researchers recommend that future researchers adopt longitudinal studies in their future studies. This technique is important in research since it allows researchers to repeat the same experiments over time. The goal is to determine whether the research has changed over time. Future researchers can use the data from this or other past studies to do a longitudinal study. Furthermore, future research might examine approaches to evaluate aspects such as an individual's smartphone usage by using an app to track phone usage. The key objective of this study was to investigate the relationship between physical activity and sleep quality among students in Kolej Komuniti Pasir Mas who have a sleeping pattern problem during covid19. As previously stated, a total of 21 questionnaires were delivered to 52 students in SPP1A, SPP1B, SPP3A, and SPP3B through the online survey technique (Google Form)

REFERENCES

- Banno, M., Harada, Y., Taniguchi, M., Tobita, R., Tsujimoto, H., Tsujimoto, Y., Kataoka, Y., & Noda, A. (2018). Exercise can improve sleep quality: a systematic review and meta-analysis. *PeerJ*, 6, e5172. <https://doi.org/10.7717/peerj.5172>.
- Bhandari, P. (2020, June 12). What is quantitative research? | definition uses and methods. Scribbr. <https://www.scribbr.com/methodology/quantitative-research/>.
- Bumgardner, W. (2019, October 29). Moderate-intensity level exercises. <https://www.verywellfit.com/what-is-moderate-intensity-exercise-3435400> bum
- Diniz, T. A., Christofaro, D. G. D., Tebar, W. R., Cucato, G. G., Botero, J. P., Correia, M. A., Ritti-Dias, R. M., Lofrano-Prado, M. C., & Prado, W. L. (2020). Reduction of Physical Activity Levels During the COVID-19 Pandemic Might Negatively Disturb Sleep Pattern. *Frontiers in Psychology*, 11. <https://doi.org/10.3389/fpsyg.2020.586157>.
- Fraser, J., Fahlman, D., Arscott, J., & Guillot, I. (2018, 02/23). Pilot Testing for Feasibility in a Study of Student Retention and Attrition in Online Undergraduate Programs. *The International Review of Research in Open and Distributed Learning*, 19. <https://doi.org/10.19173/irrodl.v19i1.3326>
- Krejcie, R. V., & Morgan, D. W. (1970). Determining Sample Size for Research Activities. *Educational and Psychological Measurement*, 30(3), 607–610. <https://doi.org/https://doi.org/10.1177/001316447003000308>
- Krishnan, V., Gupta, R., Grover, S., Basu, A., Tripathi, A., Subramanyam, A., Nischal, A., Hussain, A., Mehra, A., Ambekar, A., Saha, G., Mishra, K., Bathla, M., Jagiwala, M., Manjunatha, N., Nebhinani, N., Gaur, N., Kumar, N., Dalal, P., & Kumar, P. (2020). Changes in sleep pattern and sleep quality during COVID-19 lockdown. *Indian Journal of Psychiatry*, 62(4), 370. <https://doi.org/10.4103/psychiatry.indianjpsychiatry.523.20>
- Powell, K., & Hawes, J. (2020). What is a sleep pattern? - definition from workplace testing. <https://www.workplacetesting.com/definition/2997/sleep-pattern>.
- Sañudo, B., Fennell, C. & Sánchez, O. A. J. (2020). Objectively assessed physical activity, sedentary behavior, smartphone use, and sleep patterns pre- and during- COVID-19 quarantine in young adults from Spain. *Sustainability*, 12(15), 5890. <http://dx.doi.org/10.3390/su12155890>.
- Sleep Quality Questionnaire. (n.d.). Natural Health Protocol. <https://www.naturalhealthprotocol.com/sleep-quality-questionnaire.html>
- Suni, E. (2021). “Stages of sleep.” www.sleepfoundation.org/how-sleep-works/stages-of-sleep

- Suni, E. (2020, December 17). Sleep Quality: How to Determine if You're Getting Poor Sleep. Sleep Foundation. <https://www.sleepfoundation.org/sleep-hygiene/how-to-determine-poor-quality-sleep>.
- Wang, F., & Boros, S. (2019). The effect of physical activity on sleep quality: a systematic review. *European Journal of Physiotherapy*, 23(1), 1–8. <https://doi.org/10.1080/21679169.2019.1623314>.
- World Health Organization. (2020). Physical activity. WHO. <https://www.who.int/news-room/fact-sheets/detail/physical-activity>
- Zhou, S. J., Wang, L. L., Yang, R., Yang, X. J., Zhang, L. G., Guo, Z. C., Chen, J. C., Wang, J. Q., & Chen, J. X. (2020). Sleep problems among Chinese adolescents and young adults during the coronavirus-2019 pandemic. *Sleep medicine*, 74, 39–47. <https://doi.org/10.1016/j.sleep.2020.06.001>
- Zuki, N. A. M., Azhan, M. A. N., Kamaruddin, H. K., Kassim, A. F. M., Ahmad, M. F., & Bakar, A. H. A. (2021). Sleep quality among university students during Covid-19 lockdown. *International Journal of Academic Research in Progressive Education and Development*, 10(2): 814-822. https://hrmars.com/papers_submitted/10151/sleep-quality-among-university-students-during-covid-19-lockdown.pdf

The Role of Attitude in Explaining Gamification Adoption Among Academician in Malaysia

Zuraini binti Mohamad

*Faculty of Management and Informatics, Sultan Ahmad Shah Pahang Islamic University
(UnIPSAS)*

zuraini@unipsas.edu.my

Nur Aulia Fahada binti Misaridin

*Faculty of Management and Informatics, Sultan Ahmad Shah Pahang Islamic University
(UnIPSAS)*

fahada@unipsas.edu.my

Wan Hashridz Rizal bin Wan Abu Bakar

Faculty of Islamic Studies, Sultan Ahmad Shah Pahang Islamic University (UnIPSAS)

rizal@unipsas.edu.my

ABSTRACT

Many universities are searching for the best ways to engage students, provide course material online, and conduct evaluations. To enhance student involvement, educators use e-learning techniques including video conferencing, games, and e-books. This study examines the factors impacting academics at Malaysian private higher education institutions' intention to use gamification. This is a quantitative study that makes use of probability sampling techniques. In total, 76 samples were gathered in relation to 80 questionnaires that were disseminated throughout the institution. Findings demonstrate a significant relationship between attitude and the intention to use gamification in online learning. The implications of the study are also discussed.

Keywords: *Gamification; Attitude; E-learning; Private Higher Education Institutions*

ABSTRAK

Kebanyakan universiti sedang mencari cara terbaik untuk melibatkan pelajar, menyediakan bahan kursus dalam talian dan menjalankan penilaian. Untuk meningkatkan penglibatan pelajar, pendidik menggunakan teknik e-pembelajaran termasuk persidangan video, permainan dan e-buku. Kajian ini mengkaji faktor-faktor yang mempengaruhi ahli akademik di institusi pengajian tinggi swasta Malaysia untuk menggunakan gamifikasi. Ini adalah kajian kuantitatif yang menggunakan teknik persampelan kebarangkalian. Secara keseluruhan, 76 sampel telah dikumpulkan daripada 80 soal selidik yang diedarkan di seluruh institusi. Dapatan menunjukkan hubungan yang signifikan antara sikap dan niat untuk menggunakan gamifikasi dalam pembelajaran dalam talian. Implikasi kajian juga turut dibincangkan.

Kata Kunci: *Gamifikasi; Sikap; E-pembelajaran; Institusi Pengajian Tinggi Swasta*

INTRODUCTION

E-learning is now being used by several educational institutions in Malaysia as an alternative to the conventional teaching and learning methods. However, numerous research suggest that e-learning adoption and utilisation are poor. Therefore, the educator tries to find the best solutions to deliver course material effectively, to attract students, and to conduct evaluations. Educators have utilized e-learning technologies like games to encourage student engagement. Gamification has recently been highlighted as an effective user engagement tool with potential for online education. Gamification is a creative and entertaining way for inspiring students and

enhancing their learning according to Martí-Parreño et al. (2016). Applications like Kahoot, Mentimeter, and Quizizz, that can be simply configured and widely used in a variety of topic areas, enable the easy integration of game aspects into classroom settings.

LITERATURE REVIEW

The growth of the internet and multimedia technologies is important for facilitating e-learning. E-learning applications facilitate online access to learning materials and learning management. But it will change the educator's teaching method according to Wani (2013). According to Shurygin & Krasnova (2016) there are a number of lecturers who still practice e-learning like face-to-face lectures. Thus to encourage instructors to create digital resources, the institution must provide digital materials from a variety of courses. Gamification is one tool that encourages students to participate actively in class, learn while having fun with their classmates, highlight competitiveness, and make learning interesting (Aleksić-Maslač et al., 2018) and represents a creative and interesting strategy to motivate students and enhance their learning process (Martí-Parreño et al., 2016). The term "gamification" refers the use of game design elements to affect user behaviour in contexts other than games using game design components to influence user behaviour in non-game contexts (Urh et al., 2015). There are several studies that investigated the effects of attitude on intention to use technology. In a study by Kasilingam (2020) attitude is one of the factors that directly influence the intention to use smartphone chatbots for shopping. Another study by (Hussein, 2017) on Leading to Intention: The Role of Attitude in Relation to Technology Acceptance Model in E-Learning, demonstrates that students' attitudes play a significant effect in their desire to use an e-learning system. Analysis results according of (Cheung & Vogel, 2013) in his study of technology use, he discovered that subjective standards reflected by peers significantly influence the relationship between attitudes and intentions toward technology. His technology use model has been improved to describe the factors that influence the use of Google Applications for collaborative learning. Past research study by Adewole-Odeshi (2014) in selected south-west Nigerian universities also shows that students have a positive attitude towards e-learning. Furthermore, in study by (Weng et al., 2018) on A TAM-Based Study of the Attitude towards Use Intention of Multimedia among School Teachers shows that the intention of teachers to use multimedia was influenced by their attitude.

Therefore, we propose the following hypothesis:

H1: Attitude has a positive effect on intentions to use gamification

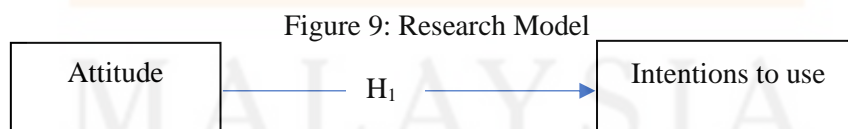

METHODOLOGY

This study aims to identify the active role in explaining the intention to use gamification among lecturers in Malaysian Islamic Private Higher Institution. The instrument used in this study was adapted from previous studies. The scale used is a Likert scale starting from 1 'strongly disagree' up to 5 'strongly agree'. We chose this scale based on the norms used by social science researchers as can be seen in the study of (Lallmahomed et al., 2017), (Almazroa & Gulliver, 2018), (Tan, 2013) and others. The sampling method used in this study was

probability sampling. We chose this sampling because we have a sampling frame. According to Krejcie and Morgan Table, a total of 80 respondents should be involved in this study but only 76 respondents answering the survey. This study was carried out using an online platform and a face-to-face survey. We distributed questionnaires through the Google Form platform and use an Excel worksheet to filter out inaccurate data.

DATA ANALYSIS

Since there is only one variable in the study model, then the statistics used to test the research hypothesis is simple linear regression. The findings of the study have proven that attitude plays a positive and significant role in explaining which to use gamification among lecturers in Sultan Ahmad Shah Islamic Pahang University portal ($\beta=0.666$, $p<0.05$) which explained about 44% of the variance. See Table 1

Table 1: Hypothesis Testing

Hypothesis Path	Coefficients	T-values	P-values	Remarks	Coefficient of Determination (R^2)
Attitude has a positive effect on intentions to use gamification	0.67	13.5	0.00	Supported	0.44

DISCUSSION

The study shows that attitude has a positive effect on intentions to use gamification among lecturers in higher education in Pahang. According to (Vanduhe et al., 2020), understanding the lecturer's behaviour in the context of his study is a significant attitude for the continued purpose of using Moodle gamified for teaching. Although other factors influence the adoption of gamification, as indicated by Varannai et al. (2017) in a study conducted with two groups of students using Kahoot! in Hungary. Their findings indicate that positive attitudes, positive experiences, and the facilities provided contribute to improving student performance, which encourages the intention to use the application.

REFERENCES

- Adewole-Odeshi, E. (2014). Attitude of students towards E-learning in South-West Nigerian universities: an application of technology acceptance model. *Library Philosophy and Practice (e-Journal)*, 1035(2014), 1–18.
- Aleksić-Maslač, K., Rašić, M., & Vranešić, P. (2018). Influence of gamification on student motivation in the educational process in courses of different fields. *2018 41st International Convention on Information and Communication Technology, Electronics and Microelectronics (MIPRO)*, 783–787.
- Almazroa, M., & Gulliver, S. (2018). Understanding the usage of mobile payment systems- The impact of personality on the continuance usage. *2018 4th International Conference on Information Management (ICIM)*, 188–194. <https://doi.org/10.1109/INFOMAN.2018.8392833>
- Cheung, R., & Vogel, D. (2013). Predicting user acceptance of collaborative technologies: An extension of the technology acceptance model for e-learning. *Computers and Education*. <https://doi.org/10.1016/j.compedu.2012.12.003>

- Hussein, Z. (2017). Leading to Intention: The Role of Attitude in Relation to Technology Acceptance Model in E-Learning. *Procedia Computer Science*. <https://doi.org/10.1016/j.procs.2017.01.196>
- Kasilingam, D. L. (2020). Understanding the attitude and intention to use smartphone chatbots for shopping. *Technology in Society*, 62, 101280. <https://doi.org/https://doi.org/10.1016/j.techsoc.2020.101280>
- Lallmahomed, M. Z. I., Lallmahomed, N., & Lallmahomed, G. M. (2017). Factors influencing the adoption of e-Government services in Mauritius. *Telematics and Informatics*, 34(4), 57–72. <https://doi.org/10.1016/j.tele.2017.01.003>
- Martí-Parreño, J., Seguí-Mas, D., & Seguí-Mas, E. (2016). Teachers' attitude towards and actual use of gamification. *Procedia-Social and Behavioral Sciences*, 228, 682–688.
- Shurygin, V. Y., & Krasnova, L. A. (2016). Electronic Learning Courses as a Means to Activate Students' Independent Work in Studying Physics. *International Journal of Environmental and Science Education*, 11(8), 1743–1751.
- Tan, P. J. B. (2013). Applying the UTAUT to understand factors affecting the use of english e-learning websites in Taiwan. *SAGE Open*. <https://doi.org/10.1177/2158244013503837>
- Urh, M., Vukovic, G., & Jereb, E. (2015). The model for introduction of gamification into e-learning in higher education. *Procedia-Social and Behavioral Sciences*, 197, 388–397.
- Vanduhe, V. Z., Nat, M., & Hasan, H. F. (2020). Continuance intentions to use gamification for training in higher education: Integrating the technology acceptance model (TAM), Social motivation, and task technology fit (TTF). *IEEE Access*, 8, 21473–21484.
- Varannai, I., Sasvári, P. L., & Urbanovics, A. (2017). The use of gamification in higher education: an empirical study. *International Journal of Advanced Computer Science and Applications*, 8(10), 1–6.
- Wani, H. A. (2013). The relevance of e-learning in higher education. *ATIKAN*, 3(2).
- Weng, F., Yang, R.-J., Ho, H.-J., & Su, H.-M. (2018). A TAM-Based Study of the Attitude towards Use Intention of Multimedia among School Teachers. *Applied System Innovation*, 1(3), 36. <https://doi.org/10.3390/asi1030036>

ACKNOWLEDGMENTS

This research is supported by grants from the Sultan Ahmad Shah Pahang Islamic University College (KUIPSAS) (Project No. RUG-KUIPSAS-2021-02).

The Effects of Transformational Leadership Style and Organizational Commitment on Member Performance (Case Study: The Nahdlatul Ulama Women's Student Association (IPPNU) Semabung Village)

Tika Indriani

Universitas Nahdlatul Ulama Surabaya
tikaindriani199@gmail.com

Ubaidillah Zuhdi

Universitas of Nahdlatul Ulama Surabaya
ubaidillah.zuhdi@unusa.ac.id

ABSTRACT

This study aims to determine the transformational leadership style and organizational commitment has an influence on the performance of members in the organization of the Nahdlatul Ulama Women's Student Association (IPPNU) Semabung Village. This study used a quantitative approach method with sampling techniques with non-probabilty sampling or saturated samples. The population in this study was 45 members. The sample used was all members of (IPPNU) Semabung Village of 45 members. Data collection by questionnaire by processing data using SPSS software version 24. Data analysis techniques use multiple linear regression. The results of this study show that transformational leadership style has a positive and significant effect on member performance, organizational commitment has a positive and significant effect on member performance, and transformational leadership style and organizational commitment srimultan have a positive and significant effect on member performance.

Keywords: *Transformational Leadership Style, Organizational Commitment, Performance*

INTRODUCTION

In organizations, it is needed by humans as the main factor to achieve a goal in the organization. The success of the organization in achieving a goal depends largely on the capabilities of human resources. Non-profit oriented organizations are organizations whose purpose is to be formed by the community voluntarily by providing services for social welfare and for the public interest. This non-profit oriented organization every member provides the best service to the community because members of the organization have an important role in solving problems in society, therefore the performance of members must be improved.

According to Sinambela in Kadir et al (2014), member performance is a job that has expertise and expertise in a certain field where a worker has the ability to carry out his work. To improve the performance of members the main key to success in organizing there is the leadership style and commitment of the organization. The factor that affects performance is that leadership is the main factor that must be owned by every organization because leadership is a source of strength to achieve organizational success. One of the factors that affect the success of the organization is the leadership style or behavior of the leader. According to Saleem (2015), the success of the organization is determined by a leader and the management of the organization. The next factor that affects performance is organizational commitment. Organizational committee according to Luthans in Inayah (2016), organizational commitment is a picture of member loyalty to an organization where the member has a high concern for an organization.

However, the results of interviews were arranged by 15 members that some members complained that the transformational leadership style that was carried out was still not good because the leader was felt to be lacking in paying attention to members in carrying out the organization and members felt that the leader did not get closer to each member. Issues related to member commitments such as the organization's commitment to the members of this organization are still not going well. The number of absenteeism that continues to decline in organizing there are some members who have difficulty in dividing time and the lack of active members in committing so that there are some members who decide to leave and the low desire of members in doing the organization.

This research took the object of research at the Organization of the Women's Student Association of Nahdlatul Ulama (IPPNU) Semambung Village which is located in the Semambung Village area, Gedangan, Sidoarjo. This organization is engaged in the religious field consisting of young women, the organization was founded in 2019. One of the problems faced by the organization of the Nahdlatul Ulama Women's Student Association (IPPNU) semambung Village is performance. The performance of members is the main factor in the IPPNU Semambung Village organization, namely the performance in implementing a work project from each department that involves many people to participate. In carrying out the performance assessment of these activities, it is necessary to need a leadership style and commitment of members, therefore the performance of members will increase because it can affect the goals of the organization. The number of members of the Nahdlatul Ulama Women's Student Association (IPPNU) of Semambung Village in 2021 consists of 45 people.

LITERATURE REVIEW

Transformational Leadership Style

Insan (2019), leadership transformational is essentially the process of relationship between subordinates and superiors that underlies beliefs and values regarding the vision and mission of the organization. According to Stephen P Robbin in Sudaryono (2017:177), transformational leadership style is a leader who expresses attention to each member and develops the needs of followers by providing encouragement to achieve organizational goals. According to Yukl (2010, p.305), there are four indicators of transformational leadership style, namely (1) Idealized Influence, (2) Individual Considerations, (3) Intellectual Stimulation, and (4) Inspirational Motivation.

Organizational Commitment

Haris (2017), organizational commitment where members choosing to stay and not to leave the organization and members believe in accepting the goals of the organization. Mekta (2016), organizational commitment is an attitude of mutual consideration member loyalty to the organization and the ongoing process of members in expressing attention to the organization. according to Steers in Sophia (2008:156) there are three indicators of organizational commitment, namely (1) Trust, (2) Loyalty, and (3) Willingness. According to Kreitner and Kinicki in Dewi (2019), there are three dimensions of commitment in the organization, namely as follow: (1) Affective Commitment, is owned by every individual who has a sense of confidence in the organization. (2) Continuance Commitment, is the result obtained to be taken into account in order for members to stay in the organization rather than leaving the organization, and (3) Normative Commitment, is a must for members to remain in the organization on moral and ethical.

Member Performance

According to Griffin in Fitriani & Sadarman (2018), performance is an outcome obtained by a member. According to (Wahid et al., 2019), performance is an assessment of individual or group results. Pamungkas (2014), performance is a behavior that is manifestly demonstrated according to the role in the organization, or the form of work produced by the member. According to Mas'ud (2014), there are five performance indicators namely as follow: (1) Quality, (2) Quantity, (3) Effectiveness, (4) Timeliness, and (5) Independence.

HYPOTHESES

H1: Transformational leadership style has a positive and significant effect on member performance

According to Tiksnayana (2018), transformational leadership style is a leadership style of leaders that makes members feel motivated and members can work beyond the leader's expectations. The results of research by Rudolf (2022), state that transformational leadership style has a positive and significant effect on member performance.

H2: Organizational commitment has a positive and significant on member performance

According to April in Dewi (2019), if the organization has a large level of organizational commitment quality from members, the higher the quality of work of a member in the organization. Sapitri (2016) on the results of performance research can influence organizational commitment positive and significant.

H3: Transformational leadership style and organizational commitment have a simultaneous effect on member performance

Transformational leadership style and organizational commitment have a simultaneous effect on member performance.

Conceptual Framework

Based on the background and literature review, the conceptual framework of this study can be described as follows.

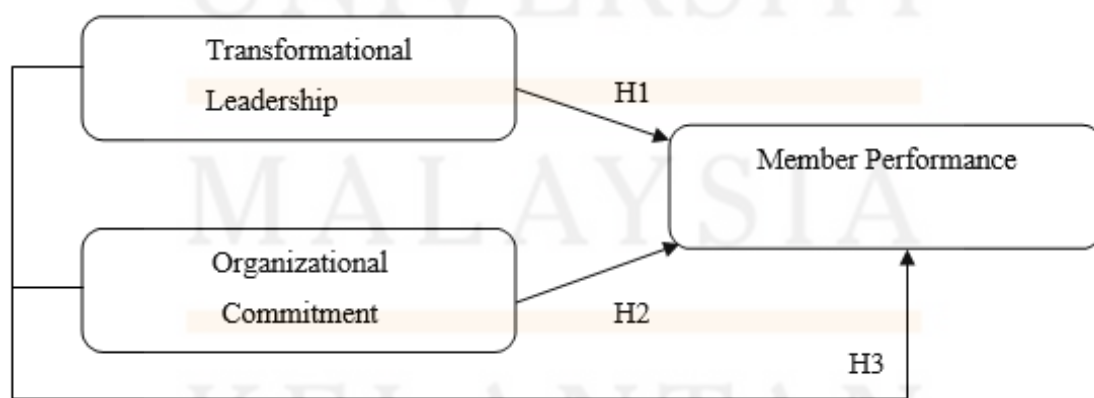

Figure 1. Conceptual Framework

METHODS

This research uses a quantitative research method approach. According to Sugiyono (2017), quantitative research is research used in researching populations or samples, data analysis using statistics, collecting data with instruments, and drawing hypotheses that have been determined. Methods used to collect data in this research is questionnaire, interviews, and literature studies. Likert scale 1-5 is a calculation method in this study. According to Sugiyono (2017:61), population is a generalization area consisting of subjects or objects that have certain characteristics and quantities that researchers set to study and draw conclusions. The population used in this study was a member of the Semambung Village Women's Student Association (IPPNU) organization totaling 45 members. According to Sugiyono (2017), the sample is the population part of the number of characteristics that the population has. This sampling technique uses a non-probabilty sampling technique or saturated sample, which uses the entire population as a sample. The samples taken in this study were members of the Nahdlatul Ulama Women's Student Association (IPPNU) organization in Semambung Village. The sampling was saturated with a total of 45 members. The data analysis technique uses multiple linear regression using the F test and the T test. By using the Statistical Package for the Social Sciences (SPSS) program software version 24.

RESULTS AND DISCUSSION

Table. 1 Validity Test Results

No.	Variable	Item Statement	Total Score of Correlation	Description
1.	Transformational Leadership Style (TLS)	TLS.1	0.385	Valid
		TLS.2	0.514	Valid
		TLS.3	0.531	Valid
		TLS.4	0.726	Valid
		TLS.5	0.718	Valid
		TLS.6	0.623	Valid
		TLS.7	0.689	Valid
		TLS.8	0.562	Valid
		TLS.9	0.414	Valid
		TLS.10	0.520	Valid
2.	Organizational Commitment (OC)	OC.1	0.507	Valid
		OC.2	0.701	Valid
		OC.3	0.699	Valid
		OC.4	0.699	Valid
		OC.5	0.717	Valid
		OC.6	0.406	Valid
		OC.7	0.631	Valid
3.	Member Performance (MP)	MP.1	0.714	Valid
		MP.2	0.731	Valid
		MP.3	0.592	Valid
		MP.4	0.546	Valid
		MP.5	0.713	Valid
		MP.6	0.658	Valid

Source: Primary Data, 2022

Tables 2 shows the results of validity test. The values of r on indicator items on each variable are greater than r value of reference. More specifically, r values on indicator are greater than 0.05. This result indicates that the question items are valid.

Table 2. Reliability Test Results

Variable	Cronbach Alpha Values	Description
TLS	0.777	Reliable
OC	0.746	Reliable
MP	0.734	Reliable

Source: Primary Data, 2022

Table 2 describes the results of reliability test. The Cronbach Alpha values are used on the test. The results indicate that the transformational leadership style, organizational commitment, and member performance variables in this study are reliable.

Table 3. Multiple Linear Regression Test Results

Model	B
(Constant)	-0.730
TLS	0.411
OC	0.286

Source: Primary Data, 2022

Table 3 explains the results of multiple linear regression test. Based on the results, the equations of multiple linear regression used in this study can be explained as follows.

$$MP (Y) = a + b_1 TLS + b_2 OC + e \quad (1)$$

$$Y = - 0.730 + 0.411 TLS + 0.286 OC + e \quad (2)$$

Above constant value explains that if the transformational leadership style and organizational commitment to member performance do not change, then the value of dependent variable will decrease by 0.730. The regression coefficient value of transformational leadership style is 0.441. Meanwhile, the value of the organizational commitment coefficient is 0.286. The other results of the test can be seen in tables 4, 5, and, 6.

Table 4. The t-Test Results

Model	t-Value	Sig.
TLS	5.881	0.000
OC	3.120	0.003

Source: Primary Data, 2022

Table 5. F-Test Results

F-Value	Sig.
39.145	0.000

Source: Primary Data, 2022

Table 6. The Coefficient of Determination

R Square	Adjusted R Square
0.651	0.634

Source: Primary Data, 2022

CONCLUSIONS

The results show that transformational leadership style has a positive and significant influence on member performance. The same phenomenon can be seen on the organizational commitment variable. Further, transformational leadership style and organizational commitment simultaneously have a positive and significant effect on member performance.

SUGGESTIONS

1. Organizational leaders of the Nahdlatul Ulama Women's Student Association (IPPNU) of Semambung Village should pay attention to the transformational leadership style and organizational commitment of the organization. One of the actions that can be done by them is to conduct properly the organization's strategy.
2. For the further researches, this study suggests to increase the number of respondents in order to get more accurate results. Besides, this study suggests to add the other variables so the member performance can be explained more comprehensively.

REFERENCES

- Dewi, J. R. (2019). *Peningkatan Kinerja Karyawan Melalui Komitmen Organisasional dan Kompetensi (Studi di PT PLN (Persero) Unit Pelaksanaan dan Pengatur Distribusi Jawa Barat)*. Skripsi pada Universitas Telkom Bandung: Telkom University Open Library.
- Fitriani, I. D., & Sadarman, B. (2018). Pengaruh Budaya Organisasi Terhadap Kinerja Karyawan Bagian Administrasi Umum pada PT PLN (Persero) Area Bandung. *Jurnal Ilmiah Manajemen Ekonomi dan Akuntansi*, 2(1), 155-172. Retrieved from (<http://journal.stiemb.ac.id/index.php/mea/article/view/55/21>) accessed 2022.
- Gemina, D., & Hakiki, M. P. (2019). Pengaruh Motivasi Anggota dan Komitmen Anggota terhadap Kinerja Anggota KPRI di Kota Sukabumi. *Jurnal Visionida*, 4(2), 9. <https://doi.org/10.30997/jvs.v4i2.1567>
- Haris, H. (2017). Pengaruh Kepuasan Kerja dan Komitmen Organisasi Terhadap Kualitas Layanan di PT. Asuransi Jasindo (Persero) Kantor Cabang Korporasi dan Ritel Bandung. *Jurnal Ekonomi Manajemen Sumber Daya*, 19(2), 135±151.
- Inayah, N. (2016). Pengaruh Motivasi dan Komitmen Organisasi Terhadap Kinerja Karyawan di Koppontren Uspps Ausath Blokagung Banyuwangi. *Istiqro': Jurnal Hukum Islam, Ekonomi dan Bisnis*, 2(2), 50-62. Retrieved from (<https://ejournal.iaida.ac.id/index.php/istiqro/article/view/29>) accessed 2022.
- Insan, Nur (2019), *Kepemimpinan Transformasional*, Bandung: CV Alfabeta.
- Kadir, A., Marnis. & Machasin. (2014). Pengaruh Ability, Motivasi Dan Pengembangan Karir Terhadap Kinerja Karyawan Redaksi PT Riau Pos Intermedia Pekanbaru. *Jurnal Ekonomi*, 22(2), 42-58.
- Mas'ud, Machfoedz. (2014). *Kewirausahaan. Metode. Manajemen. Dan Implementasi*. Yogyakarta: BPF.
- Mekta, H. Q. (2016). *Pengaruh Kepuasan Kerja dan komitmen Organisasi Terhadap Kinerja Karyawan PT. Indiara Kelana Yogyakarta*. Universitas Negeri Yogyakarta.
- Pamungkas, M. A. (2014). *Analisis Pengaruh Kepuasan Kinerja dan Komitmen Organisasi Terhadap Kinerja Karyawan (Studi Pada Perusahaan Daerah Air Minum Kota Cirebon)*. Universitas Diponegoro Semarang.

- Saleem, H. (2015). The Impact of Leadership Styles on Job Satisfaction and Mediating Role of Perceived Organizational Politics *Journal of Procedia-Social and Behavioral Sciences*, 172 (27), 563–569.
- Sanjiwani, I. M. A. dan Suana, I. W. (2016), “Pengaruh Kepemimpinan Transformasional, Kepuasan Kerja Dan Komitmen Organisasi Terhadap Kinerja Karyawan Bagus Hayden Hotel Kuta, Bali”, E-Jurnal Manajemen Universitas Udayana, Volume 5 No 2.
- Sapitri, R. (2016). Pengaruh Komitmen Organisasi Terhadap Kinerja Karyawan Perusahaan Listrik Negara Area Pekanbaru. *JOM Fisip*, 3(2), 1-9. Retrieved from <https://jom.unri.ac.id/index.php/JOMFSIP/article/view/10663> accessed 2022.
- Sinambela, Lijan Poltak. 2014. *Kinerja Pegawai Teori, Pengukuran dan Implikasi*. Yogyakarta: Graha Ilmu.
- Sudaryono, (2017), Pengantar Manajemen, Cetakan Pertama. Yogyakarta: Penerbit CAPS (Center for Academic Publishing Service).
- Sugiyono (2017), *Metode Penelitian Bisnis (Pendekatan Kuantitatif, Kualitatif dan R&D)*, Bandung: CVAlfabeta.
- Vipraprastha, T., Sudja, I. N. and Yuesti, A. (2018) ‘The Effect of Transformational Leadership and Organizational Commitment to Employee Performance with Citizenship Organization (OCB) Behavior as Intervening Variables (At PT Sarana Arga Gemeh Amerta in Denpasar City)’, *International Journal of Contemporary Research and Review*, 9(02), pp. 20503–20518. doi:10.15520/ijcrr/2018/9/02/435.
- Wahid, D., Supriyati, & Herawati. (2019). Pengaruh Gaya Kepemimpinan dan Disiplin Kerja terhadap Kinerja Karyawan PT. FIF (Federal International Finance) Cabang Muara Bungo. *Jurnal Administrasi Sosial Dan Humaniora (JASIORA)*, 3(2), 88–96. <https://doi.org/10.5281/zenodo.3258076>.

Western Corporate Communication Model for Local Entrepreneurs

Asma Azman
University Malaysia Kelantan
asmabtazman@gmail.com

Azman Bidin
University Malaysia Kelantan
azman.bidin@umk.edu.my

Maziha Mustafa
Kolej Komuniti Pasir Mas
maziha@kkpmas.edu.my

ABSTRACT

Communication is crucial for most organizations to ensure the management and employees' activities run effectively. It is about how organizations' executives connect with the media and the public on important organizational developments. Corporate communication is the interaction between businesses and organizations with a wide range of internal and external audiences. The most common audiences are the employees, the media, customers, the public, government agencies, and other third-party regulators. The objective of this study is to assist local entrepreneurs by understanding a model of successful corporate communication to achieve organizations' growth and maintain a credible corporate reputation. This paper reviewed several studies on corporate communications strategies, platforms, purposes, and how to engage effectively with target audiences. Thus, the research covered western businesses' fundamentals of corporate communication. Effective communication will help organizations stand out more positively in the market than competitors.

Keywords: Business Communication, Corporate Communication, Multinational Companies, Local Entrepreneurs.

ABSTRAK

Komunikasi adalah penting bagi kebanyakan organisasi untuk memastikan pengurusan dan aktiviti pekerja berjalan dengan berkesan. Ia adalah mengenai cara eksekutif organisasi berhubung dengan media dan orang ramai mengenai perkembangan organisasi yang penting. Komunikasi korporat ialah interaksi antara perniagaan dan organisasi dengan pelbagai khalayak dalaman dan luaran. Khalayak yang paling biasa ialah pekerja, media, pelanggan, orang awam, agensi kerajaan dan pengawal selia pihak ketiga yang lain. Objektif kajian ini adalah untuk membantu usahawan tempatan dengan memahami model komunikasi korporat yang berjaya untuk mencapai pertumbuhan organisasi dan mengekalkan reputasi korporat yang boleh dipercayai. Kertas kerja ini mengkaji beberapa kajian mengenai strategi komunikasi korporat, platform, tujuan, dan cara untuk melibatkan diri secara berkesan dengan khalayak sasaran. Oleh itu, penyelidikan merangkumi asas komunikasi korporat perniagaan barat. Mempunyai komunikasi yang berkesan akan membantu organisasi untuk menonjol secara positif dalam pasaran berbanding pesaing lain

Kata kunci: Komunikasi Perniagaan, Komunikasi Korporat, Syarikat Multinasional, Usahawan Tempatan.

INTRODUCTION

Communication is crucial for most organizations to ensure the management and employees' activities run effectively and achieve strategic goals. It is about how organizations' executives connect with stakeholders, media, and the public on important organizational developments thus, the organization's products and services will appear to be unique to consumers compared to their competitors (Stobierski, 2019).

Corporate communication is the interaction between businesses and organizations with a wide range of internal and external audiences. The most common audiences are stakeholders, employees, the media, customers, the general public, government agencies, and other third-party regulators. The three forms of corporate communications are written (advertisements, emails, press releases), verbally (press conferences, meetings, interviews), and visually (infographics, branding, photographs). The corporate communication team is responsible for maintaining a positive corporate reputation by building the company image, bridging the gap between management and employees, and communicating with internal and external audiences (Khan, 2020).

Corporate communication plays a vital role which serves many purposes and can be delivered through many platforms to achieve organizations' growth and maintain a credible corporate reputation. Effective corporate communication enhances an organization's revenue, customer loyalty and sustainability in their industry. Due to the variety of audiences, organizations need to develop a strong communication strategy that ensures effective coverage with all stakeholders. Most organisations' communications departments hired specialists responsible for overseeing a broad range of communications activities. These specialists in many areas of the department communicate and engage effectively with their respective target audiences (Indeed, 2021). The primary functions that describe corporate communications are internal communication, corporate advertising, investor relation, media relation, government relation, and crisis communications.

A study by Goi & Yong (2009) stated that private and publicly listed companies in Malaysia had started to focus on Corporate Social Responsibility (CSR) – one of the corporate communication functions to gain customer trust, raise awareness and encourage positive changes in the community. However, local entrepreneurs' effort is still not enough compared to renowned companies and multinational companies in Malaysia who are actually doing their part for CSR with far-reaching results with prosocial initiatives seen by the public. For that reason, it is crucial for local entrepreneurs to showcase efforts on CSR by protecting the planet, driving equity, and improving the quality of a community. Thus, the objective of this study is to assist local entrepreneurs by understanding a model of successful western corporate communication to achieve organizations' growth and maintain a credible corporate reputation.

INTERNAL COMMUNICATION

Internal communication is simply about promoting effective communication among people within an organization – the internal stakeholders. It is a part of an organization's Human Resources (HR) which helps staff, managers, and executives with their activities and achieve the organization's goals. It is crucial to communicate regularly and clearly with people within an organization to keep them engaged, and well-informed, and to provide a holistic view of the organization (Hopkins, 2015). The three primary components of internal communications are employee communication, organizational culture, and stakeholder communication. Examples

of corporate communication in internal communications are facilitating training amongst employees, drafting emails, creating printed adverts, and announcing company news.

CORPORATE ADVERTISING

Advertising aims to increase interest by customers and the public by describing the company overall rather than focusing on describing its products. Corporate communication strategy and advertising strategy influence each other, and they can create a positive image of the brand. Corporate advertising focuses on marketing the overall company's identity and image. It can boost the attractiveness of the company and convince people of job opportunities. The objective is to establish a positive image and reputation for the company, create a bond of trust with customers, and recruit personnel. In other words, corporate adverts build the company's name to focus on promoting the brand's strength and reputation and enhancing local business conditions. There are three types of corporate advertisements in corporate communications.

Image advertisements are designed to promote the company's overall image. The objective is to create a position and goodwill for the company as well as general resources. It can be a very simple advert by only providing the company's name and logo. Image advertising aims to improve a company's reputation or increase acknowledgement of its importance to its competitors. For example, the American multinational fast food corporation – McDonald's advert its "M" logo minimalistic on the big hoardings put alongside highways without the brand name but managed to create conscious awareness among customers (Coggan, 2021).

Advocacy or opinion advertising attempts to influence public opinion on issues of importance to the company. The objective is to give an impression and the public's attention by doing public service. These adverts may not mention the company's name majorly, however, it often provides some public benefit that is tied to the company's interests. Apple Inc. is an American technology company with strategic marketing that design, manufacture, and market various devices and offer software and related services. An advocacy advert example by Apple is by devoting to their 'Shot on iPhone' campaign by using real-life selfies and original photos taken by their customers using their products and advert them on television, commercials, billboards, and paid adverts (Carter, 2020). This shows their uniqueness, strong brand-customer relationship and encouraging consumers to share their experience with Apple products.

In cause-related advertising, companies link with charities or non-profit organisations as contributing sponsorship. The company works to increase their sales by allowing customers to donate to a cause they might support. Advocacy adverts believe and support the cause which is connected to their corporate values whereas cause-related adverts support the cause to increase sales for the company. In 2020, British beauty and perfume company The Body Shop start the "Time To Care" campaign to thank healthcare workers for their dedication. The company promotes practising self-care and the campaign aims to support health, wellness and kindness, therefore the brand partnered with assisted living communities and shelters to donate cleaning supplies (Carmicheal, 2020).

The main priority of effective corporate advertisements and corporate communication teams is by building and maintaining a positive and strong brand image, identity, and reputation of a company.

Corporate Image refers to the image the public perceives in their mind about the company and its products and services also known as brand. It highly influences the opinion of customers about the company in the market. Having a positive corporate image helps increase sales, and attract customers, shareholders, and business partners. Corporate image continuously changes over time therefore it is important to put in additional effort to stay in the market for the long term. The corporate image includes the company logo, slogan, and packaging designs.

Dunkin Donuts is an American multinational coffee and doughnut company founded in Massachusetts in 1950. Other than its baked goods and coffee, Dunkin' is creative in marketing strategies, CSR, and creating new ideas for the brand. In 2016, Dunkin' Donuts updated its logo which represents the name of the company itself as the doughnut being 'dunked in' a mug (Estella, Sayed, Anandan & Jeevan, 2016). The colour template for the logo is white, orange and pink which reflects their cleanliness, affordability, creativity, and innocence. Therefore, it attracts customers with the contrasts of the logo with the colour of their products, specifically coffees. Dunkin' Donuts' vision focuses on transforming the firm into an iconic and desired entity, whereby the mission is to outperform all rivals with high-quality products (Samuel, 2021).

Corporate Identity speaks of the company's ethics, values, and focus on the offered products and services. A strong corporate identity can positively influence people's thoughts and opinions toward the company. A study by Michaels and Grüning (2018) shows that corporate identity is related to the early stage of CSR. CSR refers to a management concept whereby companies play a positive role in the community and voluntarily integrate social and ecological concerns into their business activities and aim to have a positive brand image to the public (Ashrafi, Adams, Walker, & Magnan, 2018). Dunkin' has an independent section for their CSR on their corporate website (Dunkin Newsroom, 2022) which publicly show the many fundings made towards the community. A study (Lavoie, 2015) showed the corporate communication of Dunkin' Donuts whereas the communication strategy is heavily focused on the consumers and fans of the brand. Their social media Instagram encourages fans to interact and share stories. The study also mentioned in 2013, social media campaign called '#mydunkin' inspires fans to share Dunkin' Donuts moments, with some fans even featured in advertisements

Corporate Reputation is the views and beliefs held by the public about the company based on its history. It influences consumer purchasing behaviour, the company's sales and the stakeholders. Having a positive corporate reputation is very difficult for organizations to maintain and remain once a crisis occurs. For example, a recent incident in Tampa, Florida has discredited the reputation of Dunkin Donuts where an employee assaulted a 77-year-old customer after using a racial slur and caused death (Fox 13 News, 2021). Therefore, Dunkin' needed to carry out strategic actions to overcome this tragedy.

INVESTOR RELATION

Investor relation (IR) is another term for financial relations and shareholders relations. It is a division of a company to combine communication, finance, and marketing that effectively balances information between the management of a public company and shareholders. It is highly beneficial to build and maintain strong relationships with the investors who play a major role in a company's growth and success. Therefore, the IR department is very important to take care of accurate and factual information for the public as it is a part of the public relations

department. For instance, in 2020, Dunkin' Brands International (DNKN) joined the Nasdaq group - an American multinational financial services corporation that owns and operates stock exchanges in the United States along with Apple, Amazon, and Tesla (Caplinger, 2020). In an interview with Nasdaq (Gosman, 2017), Stacey Caravella, head of Investor Relations with almost 10 years working with Dunkin, Caravella claimed that Dunkin's IRO follows the 'open-door policy where the team would open dialogues even tough conversations with investors by accommodating most requests for meetings, conferences, and phone calls. She addressed the importance of having an intimate knowledge of the business and building great relationships with other teams in the IR department.

MEDIA RELATIONS

Media relation is the mutually beneficial interaction between an organisation's public relations professionals with editors, journalists, and influencers. It aims to communicate a newsworthy story using media outlets such as the internet, magazine, television, radio, and newspapers. Media relations can build brand awareness, increase credibility, and help reach out to larger audiences. For example, Dunkin' is also known for its effective communication in direct engagement with the community and its customers. Through its official websites, Dunkin' provides a press kit for members of the media to promote their events, organisations, and products. Dunkin' also has a good working relationship with the media to spread messages, stories, and news to the target audience. During the early '80s, Dunkin' featured Michael Vale - a character actor as their durable spokesperson for 15 years for their television commercials.

Furthermore, Rejrat (2022) and Pollitz (2022) made a press release for Dunkin's upcoming branch through the newsletter website LancasterOnline and The Commercial Dispatch respectively. Therefore, it benefits Dunkin' to bring awareness and spread the news to its customers. In addition, FOX TV Digital Team (2022) made an announcement on Dunkin' new items on the menu along with the return of other seasonal favourites. According to Meisenzahl (2021), Dunkin' made a partnership with Charli D'Amelio - an influencer with the most followed individual on the platform Tiktok which remarkably boosted their cold brew sales and 57% increase in their application downloads. Other endorsers for Dunkin are SnoopDog the American rapper and Kim Soo Hyun as Dunkin's newest brand ambassador.

GOVERNMENT RELATION

Government relation (GR) is under the public relations umbrella along with investor relations and media relations. Government relations focus on interacting and building relationships between an organization with the government and its various officials and branches. The communications used in this department include conversations directed to governmental representatives, discussions on regulatory issues, and lobbying efforts on behalf of the organization. A government relations manager manages through subordinate managers and professionals in larger groups with moderate complexity. A GR manager should have high knowledge of government processes, understand how to work with lobbyists, and bond a relationship with key lawmakers. Having an effective government strategy is important because it helps organizations understand clients better and move in the right direction. In 2015, Michael R. Shutley joined the Dunkin' Brands Group as the vice president, of federal and state government affairs (Qsr Web, 2015). Shotley is responsible for implementing and developing the company's legislative initiatives as well as being an advocate for Dunkin' Donuts and Baskin-Robbins franchises domestically and internationally according to a company press release.

CRISIS COMMUNICATION

A crisis in an organization occurs unexpectedly and crisis management focuses on how stakeholders cope with the negative event due to human error, economic instability, technological crisis, or active nature (Bukar, Jabar, Sidi, Nor, Abdullah, & Othman, 2020). Crisis communication refers to the process of communication in which organizations construct the meaning the present crises hold. Crises can affect any type of organization including government, private sectors, or hybrid organizations even with a good reputation, management, and products. (Park, Bier, & Palenchar, 2016). They are unpredictable events that inevitably threaten important expectancies of stakeholders and can affect seriously the organization and generate negative outcomes. Organizational crises create demands for information therefore communication is important in stakeholder reaction management and crisis knowledge management process (Zakaria, Yusnaldi, & Latiff, 2021). In other words, crisis communication refers to the collection, processing, and dissemination of information required to cope with a crisis. Organizations must be prepared to effectively communicate during this major threat to the business or its reputation to protect customers, shareholders, stakeholders, company's assets, and ensure business continuity.

According to Nester (2017), as the Senior Vice President and Chief Communications Officer at Dunkin' Brands since 2009, Raskopf has faced and coped fair share of communication crises over the years and finds it challenging. Because of the unpredictability of crises, she advises always to be prepared and aware of these threat events. Raskopf shared an incident where an advertising campaign that did not get corporate approval for its release in Dunkin's branch in Thailand. The advertising was perceived as insensitive and racist, negatively representing an American company. The Brand apologize and pulled down the campaign after getting commented on by a reporter from the Associated Press. Therefore, communication management is crucial when crises occur to prevent the spreading of false information which can threaten the company's reputation and image. Moreover, communication management is important before, during, and after a crisis to ensure the organization could recover and continue functioning afterwards.

CONCLUSION

Corporate communications are an incredibly broad field with the definition of a variety strategy used by organizations to communicate with their internal and external audiences. Corporate communication is beyond the fundamental of communication by fostering a unified brand identity and a positive image and reputation. This communication ensures that the organization can reach out and interact with audiences such as investors, media, government, public and stakeholders using various strategies and channels to effectively influence the audience's opinion and actions about the company.

Effective communication will help local organizations stand out more positively in the market than competitors. Although it can be challenging and requires a big team to operate efficiently, it helps the management and employees to coordinate their activities and focuses on the organizational goals. Moreover, it is crucial to strategically plan communication for internal and external audiences to achieve success in the business world. Otherwise, poor communication with the target audience may affect the company's identity and reputation.

In the current digital age, corporate communication has become wider compared to the times before. It covers emailing employees and conducting a press release on a new product,

doing online press conferences, and making advertisements with consumers using the social media platform. Therefore, strong, and effective corporate communication will help local businesses in various ways to increase sales and maintain positive relationships with stakeholders, shareholders, media, government, and the general public.

REFERENCES

- Ashrafi, M., Adams, M., Walker, T. R., & Magnan, G. (2018). How corporate social responsibility can be integrated into corporate sustainability: A theoretical review of their relationships. *International Journal of Sustainable Development & World Ecology*, 25(8), 672-682.
- Bukar, U. A., Jabar, M. A., Sidi, F., Nor, R. N. H. B., Abdullah, S., & Othman, M. (2020). Crisis informatics in the context of social media crisis communication: Theoretical models, taxonomy, and open issues. *IEEE Access*, 8, 185842-185869.
- Caplinger, D. (2020). *The 3 Most Important Nasdaq Stocks on Monday*. The Motley Fool. Retrieved September 4, 2022, from <https://www.fool.com/investing/2020/10/26/the-3-most-important-nasdaq-stocks-on-monday/>
- Carmicheal, K. (2020). *10 Cause-Related Marketing Campaign Examples That Inspire Us*. Retrieved October 7, 2022, from <https://blog.hubspot.com/agency/5-tips-to-boost-your-next-cause-marketing-campaigns-reach>
- Carter, H. (2020). *#ShotoniPhone: A Picture Perfect Campaign*. Retrieved October 7, 2022, from <https://hayleycarter-39668.medium.com/shotoniphone-a-picture-perfect-campaign-93e54b89bab0>
- Coggan, G. (2021). *The McDonald's logo, like you've never seen it before*. Retrieved August 4, 2022, from <https://www.creativebloq.com/news/mcdonalds-half-arch>
- Dunkin' Joy in Childhood Foundation Celebrates Its Four-Legged "Dog-tors" on National (Furry) Employee Appreciation Day!. (2022). Dunkin' Donuts News. Retrieved July 27, 2022, from <https://news.dunkindonuts.com/blog/dunkin-dogtors-national-employee-appreciation-day>
- Estella, A. L. M., Sayed, A., Anandan, B., & Jeevan, C. (2016). Global Branding & Identity (Dunkin' Donuts).
- Fox 13 News staff. (May 11, 2021). *Tampa PD: Dunkin Donuts customer who used racial slur dies after being punched by the employee*. Fox 13 News. Retrieved August 11, 2022, from <https://www.fox13news.com/news/tampa-police-dunkin-donuts-customer-who-used-racial-slur-dies-after-being-punched-by-employee>
- FOX TV Digital Team. (2022). *Dunkin' add cornbread doughnuts and doughnut holes to the menu*. FOX 7 Austin. Retrieved August 28, 2022, from <https://www.fox7austin.com/news/dunkin-adds-cornbread-donuts-donut-holes-to-menu?taid=626c209a5d112f00014777ce>
- Goi, C. L., & Yong, K. H. (2009). Contribution of public relations (PR) to corporate social responsibility (CSR): A review on Malaysia perspective. *International Journal of Marketing Studies*, 1(2), 46.
- Gosman, A. (2017). *Intro To An IRO: Stacey Caravella*. Nasdaq. Retrieved August 11, 2022, from <https://www.nasdaq.com/articles/intro-iro-stacey-caravella-2017-03-24>
- Hopkins, A. E. (2015). "A Framework for Internal Corporate Communications." *Inquiries Journal/Student Pulse*, 7(09). Retrieved August 2, 2022, from <http://www.inquiriesjournal.com/a?id=1177>
- Indeed Editorial Team. (2021). *What Is Corporate Communications and Its Primary Functions?*. Indeed. Retrieved August 7, 2022, from <https://sg.indeed.com/career-advice/finding-a-job/what-is-corporate-communications>

- Khan, H. (2020). *What is Corporate Communication?*. Simplr. Retrieved July 8, 2022, from <https://www.simplr.com/blog/2020/what-is-corporate-communications/>
- Lavoie, K. A. (2015). Instagram and Branding: A Case Study of" Dunkin'Donuts". *Elon Journal of Undergraduate Research in Communications*, 6(2).
- Meisenzahl, M. (2021). *This is how Dunkin' has changed since it dropped the 'Donuts'*. Business Insider. Yahoo Sports. Retrieved August 29, 2022, from <https://sports.yahoo.com/dunkin-changed-since-dropped-donuts-103000573.html>
- Michaels, A., & Grüning, M. (2018). The impact of corporate identity on corporate social responsibility disclosure. *International Journal of Corporate Social Responsibility*, 3(1), 1-13.
- Nester, C. (2017). *Coffee and Crisis: Lesson's from Dunkin' Brands' CCO*. College of Communication PR Lab. Retrieved October 2, 2022, from <https://www.bu.edu/prlab/2017/03/24/coffee-and-crisis-lessons-from-dunkin-brands-cco/>
- Park, S., Bier, L. M., & Palenchar, M. J. (2016). Framing a mystery: Information subsidies and media coverage of Malaysia airlines flight 370. *Public Relations Review*, 42(4), 654-664.
- Pollitz, M. (2022). *Mary Means Business: Dunkin' Donuts coming to Starkville*. The Commercial Dispatch. Retrieved September 1, 2022, from <https://cdispatch.com/news/2022-05-05/mary-means-business-dunkin-donuts-coming-to-starkville/>
- QSR Web. (2015). *Dunkin' announces new VP of federal & state government affairs*. QSR Web. Retrieved August 29, 2022, from <https://www.qsrweb.com/news/dunkin-brands-group-inc-announces-new-vice-president-federal-state-government-affairs/>
- Rejrat, A. (2022). *New Dunkin' Donuts planned for former Sonic in Lebanon County*. LancasterOnline. Retrieved July 7, 2022, from https://lancasteronline.com/news/regional/new-dunkin-donuts-planned-for-former-sonic-in-lebanon-county/article_e791358a-cc89-11ec-a74a-a3f86c77786d.html
- Samuel. (2021). *Dunkin doughnuts mission and vision statement analysis. Inspiring Job Search Stories. How I Got Job*. Retrieved July 8, 2022, from <https://howigetjob.com/mission-statement/dunkin-donuts-mission-vision-and-statement/>
- Strobierski, T. (2019). *What is Corporate Communications? Functions, Careers, and Skills*. Northern University. Retrieved July 8, 2022, from <https://www.northeastern.edu/graduate/blog/what-is-corporate-communications/>
- Tatum, M. (2022). *What is Corporate Advertising?*. *Smart Capital Mind*. Retrieved September 15, 2022, from <https://www.smartcapitalmind.com/what-is-corporate-advertising.htm>
- Zakaria, M. H. F., Yusnaldi, N., & Latiff, Z. A. (2021). Crisis Communication Strategies During the Code Red Phase of Aviation Industry and Media Framing Discrepancies: Case of Malaysia Airlines Twin Tragedy. *Journal of Media and Information Warfare* Vol, 14(2), 105-121.

Religious Motivations for Everyday Life from a Hadith Context and Potential Wonders

Mohd Arif Nazri

The National University of Malaysia (UKM)
mohdarif@ukm.edu.my (Corresponding author)

Nur Farhah Zainan Nazri

PhD Holder of Islamic Science University of Malaysia (USIM)
farhahnazri@gmail.com

Mohammad Ikram Mohd Nor

Teacher at SM Imtiaz YT Besut
mohammadikram29@gmail.com

Faris Izwan Nordin

Student of The National University of Malaysia (UKM)
a180600@siswa.ukm.edu.my

ABSTRACT

Many motivators use ahadith in motivation to make a speech has substance and sourced. This study is a modest attempt that aims at identifying some issues in the use of hadith related to motivation. The researchers found that there are five most important problems in the use of hadith related to motivation which are the lack of stating the validity of hadith, the existence of hadith daif (weak) and maudu' (fabricated), the misconception of the text of ayah or hadith and the influence of hadith masyhur and the lack of using books of hadith based on al-Tarhib wa al-Tarhib. This study implies that the techniques of reward and punishment based on authentic hadith can be the significant solution in motivation. Further research on motivation based on authentic hadith can be conducted on a larger scale including the biological, emotional, social, and cognitive aspects to obtain better result.

Keywords: *Motivation, authentic (sahih); good (hasan); weak (da'if) and fabricated (maudu') ahadith*

ABSTRAK

Banyak penyampai motivasi menggunakan ahadith dalam motivasi untuk menjadikan ucapan mereka mempunyai asas dan sumber. Kajian ini adalah usaha sederhana yang bertujuan untuk mengenal pasti beberapa masalah dalam penggunaan hadis yang berkaitan dengan motivasi. Para penyelidik mendapati bahawa terdapat lima masalah yang paling utama dalam penggunaan hadis yang berkaitan dengan motivasi iaitu kurangnya usaha menyatakan keabsahan hadis, wujudnya hadis daif (lemah) dan maudu' (palsu), salah tanggapan teks ayah atau hadis dan pengaruh hadis masyhur dan kurangnya penggunaan buku-buku hadis berdasarkan al-Tarhib wa al-Tarhib. Kajian ini menunjukkan bahawa teknik ganjaran dan hukuman berdasarkan hadis sahih dapat menjadi jalan penyelesaian yang signifikan dalam motivasi. Penyelidikan lebih lanjut mengenai motivasi berdasarkan hadis sahih dapat dilakukan pada skala yang lebih besar termasuk aspek biologi, emosi, sosial, dan kognitif untuk mendapatkan hasil yang lebih baik.

INTRODUCTION

The world currently is experiencing the development of science as well as the rapid change of information technology. Thus the existence of the term "world on your fingertips" for instance is common to the Muslim community. "Information easily accessible on-line"; is widely used regardless of age and without limitations. All forms of this progress have changed the mindset in addition to socio-cultural Muslim community.

In fact, changes that occur towards a better life and that will strengthen Muslim identity itself is highly encouraged in Islam. However, if the changes lead to a breakdown in moral and alienate one with Allah S.W.T; then it is a negative change that should be absolutely rejected.

The impact of these rapid technological advances, particularly on Muslims in Malaysia; are exposed to a variety of information that is not filtered up to raise pitch vice and depravity in society. However, there is a lot of propagation efforts strived by Muslims continuously to advise people not to default in the obedience of Allah S.W.T as the Prophet Muhammad S.A.W said:

Al-Nu'man bin Bashir r.anhuma said: the Prophet Muhammad S.A.W said: "The parable of people who reject the law of Allah S.W.T and those who establish it; like a group of people who sail with a ship, some of them are sitting on the bottom of the ship, and others sit on it. So people who are under the ship, when they need water, they have to go through the ones that are above; thus bother them (the person above). And one that is under; taking an axe to make a hole in the bottom of the vessel. So they (the person below) came on and the people (persons above) said: "what have you done." They (the people below) said: "You all have been disrupted due to me, while I need water." If they had (the person above) prevented with their hands, then they have saved the person and also themselves, but when they let that thing happened, then the people will perish and also themselves." (Narrated al-Bukhari, 2686)

Among the best method of advising people is via the use of motivation as a medium of da'wah. Motivation is regarded as a simple and remarkable way to give admonition to the public. This is in accordance with the Prophet proposition in advising someone. The Prophet Muhammad S.A.W said:

"Whoever among you sees evil let him change his hand, if not able, let him change it with his tongue, if not able, let him change it with his heart, and that is the weakest level of faith." (Narrated Muslim 78(39)).

Motivation is now one of the most popular platforms among Malaysians especially among school students. These groups are targeted; aimed to encourage them to leverage a paradigm shift in every area they adore. Nowadays, we get a glimpse of the motivators involved; growing rapidly in this field. Motivational talks ever seen dominate this growing Malaysians with modules of various shapes such as School Holiday Camps, Summer Camp, Training Moral Building, Smart Prayer Workshop and others.

Moreover, there are motivators that use radio and TV as a field to deliver motivational talks etc with various pedestals and target dimensions. The publication of books, magazines, websites, as well as CD software also among others in the field again expands their delivery route.

Various forms used by the motivators do not away from the use of evidences from the Qur'an and the Sunnah. It aims to strengthen their arguments and convince the audience with what they have said. Yet the question is, do all the arguments mentioned by them, particularly the hadith of the Prophet Muhammad S.A.W's validity was reviewed before being disseminated? This concern is to abolish the possibility of lying against the Prophet Muhammad S.A.W, as he said:

From al-Mughirah r.a, he said: "I heard Allah's Messenger said:" Indeed lie against me is not the same as lying to someone, whoever lie against me intentionally, then prepare a place from hell." (Narrated al-Bukhari 1291)

Therefore, the contents of motivation that uses the hadith of the Prophet Muhammad should be taken from the authentic source and the status of the hadith should be revealed. In other words, with regard to the grading of ahadith, those recorded in Sahih al- Bukhari and Sahih Muslim are deemed authentic, while the ahadith which are found in various books of Sunnah, which the speaker/motivator will refer to, contain authentic (sahih), good (hasan), weak (da'if) and fabricated (maudu') ahadith. The speaker/motivator needs to mention the grades of the ahadith quoted from other than Sahih al- Bukhari and Sahih Muslim, relying on the analysis of scholars; traditional and contemporary. Hence, this scholarly responsibility should rest with the Muslim community in general and in particular the motivational speaker/motivator (Ibn Taymiyyah, 2005).

ISSUES IN THE USE OF HADITH RELATED TO MOTIVATION

Motivation has become the main platform in the delivery of knowledge, especially relating to the matters brought to the spirit, enthusiasm, encouragement and stimulus for every field of endeavor or even basic human life. Even this kind of scientific spread will apply these systematic arguments or evidences from the Qur'an and hadith to make a speech has substance and sourced.

The tendency of each motivator that uses evidences from the Qur'an and hadith in motivation because it is believed to be true and reliable. According to Dato' Dr. Hj Mohd. Fadzilah Kamsah et al (2006) naturally, everyone has a soft spot and verses from the Qur'an and hadith are able to soften human psychology. In fact, it is something that has been exemplified by the best motivator namely the Prophet Muhammad S.A.W. In addition, his duty as a motivator has been also recorded in the Quran. Allah S.W.T says:

And We send not the Messengers except as givers of glad tidings and warners.
(al-Quran, al-Kahf 18:56)

Allah mentions that the Messengers were sent as the giver of glad tidings and warner. This is one of the vital forms of motivation where there is an element of reward and punishment. In fact, the Prophet S.A.W. is a very appropriate figure emulated motivator to the whole mankind.

Not Stating The Validity Of Hadith

The use of the Qur'an in motivation does not have a very big problem because its purity is guaranteed by Allah S.W.T., as He says:

We who sent down the Quran, and We are its Guardian. (al-Quran, al-Hijr 15:9)

Therefore, there is no significant problems associated with the use of verses of the Qur'an in motivation. On the other hand, the use of hadith al-Nabawi in motivation seen to have some problems while its use is enormously. Among the problems that can be seen is the used of hadith does not get its rights in the study of takhrij. This occurs when the ahadith that are recorded in other books of hadith but in al-Bukhari and Muslim, the legal status of the hadith is not stated.

For example, the hadith that are existed in book *Kemahiran Mendidik Anak – Menangani Anak Bermasalah* (Fadzilah Kamsah et al, 2006). The book mentioned nearly nine hadith in motivation, but the validity of five of them has not been mentioned even the sources of the narrations have been stated and the rest of the hadith are narrated by al-Bukhari and Muslim.

In a similar vein, in *Petua Mendidik Anak Menjadi Insan Positif* (Fadzilah Kamsah et al, 2006). There are approximately twenty one hadith connote motivation oriented, yet the author merely mentioned the validity of two hadith i.e. narrations in other than al-Bukhari and Muslim and one hadith narrated by al-Bukhari in Adab al-Mufrad. The remaining; nearly thirteen hadith the author has neither disclosed their status nor the source of narration of five of them.

The Existence Of Hadith Da'if (Weak) And Maudu' (Fabricated)

According to Dr. Mashitah Ibrahim (Berita Harian 2012), although the spread of fabricated hadith through a variety of mediums remains controlled, but it is considered as a dangerous act, confusing and threaten the purity of religion. They even included among those that lie on the Prophet.

Lack of proficiency in the source of knowledge, especially in the science of hadith may cause various negative impacts such as the spreading of fabricated hadith, the lack of conciousness about the status of the hadith and the emergence of practices that are not based on the Prophet Muhammad's practices. Islam on the other hand, emphasizes Muslims on the use of authentic evidences that trigger the effective delivery to the listener.

Examples of Hadith Da'if (Weak) related to motivation:

The prayer is the pillar of the religion, and he abandons it indeed he had destroyed the religion. (Narrated al-Baihaqi 2807)

Love the Arabs for three; because I am an Arab and the language of the people of Paradise is Arabic and the Qur'an is in Arabic. (al-Hakim 294; al-Haithami 52/10)

I have been taught by my Lord the best manners, whoever wants the best manners may take them from me. (al-Munawi 1/225; al-Ajluni 164; al-albani 36)

Seek knowledge; even if it is in China. (al-Baihaqi 1663; al-Albani 17, Ibn Jauzi 216/1)

I am the city of knowledge and Ali is its gate, whoever desires knowledge let him enter the gate. (al-Ajluni 618; al-Asqalani 513; al-Darqutni 386)

Prayer is the weapon of the believer. (al-Hakim 1812; al-Haithami 147/10; al-Asqalani 5820; al-Dhahabi 7378; al-Albani 179)

Fast, you will be healthy. (al-Mubarakfuri 1450; al-Haithami 179/3; al-Dhahabi 188/8; al-Asqalani 2049)

Examples of Hadith Maudu' (Fabricated) related to motivation

Difference of opinion in the Muslim community is a sign of divine favor. (al-Sakhawi 39; al-Munawi 212/1; al-Albani 57)

The love of this world, it is the root of every sin. (Ibn Taimiyyah 35-34/10; al-Munawi 369/3; al-Albani 1226)

Love of the homeland is a part of one's faith. (al-Ajluni 1102; al-Sakhawi 286; al-Masnu' 106)

Whoever knows himself, knows his Lord. (al-Sakhawi 1149; al-Asbahani 386/6; Mulla al-Qari 937; al-Albani 66)

This worldly life is the farm of the Hereafter. (al-Asqalani 230/11, Mulla al-Qari 372; al-Ajluni 1320; al-Jauzi 1332)

Rajab is the month of Allah S.W.T., and Sya'ban is my month and Ramadhan is the month of my nation. (al-Mundhiri 1494; al-Munawi 18/4)

Influenced by Hadith Masyhur

Mohamad Hasbullah Salim (2011) said in his paper that some people misled by hadith Masyhur used in motivation because it is well known then some of them deem that it is fine and simply accept it; while this is against to the discipline of hadith. This is because the hadith Masyhur can be sahih, daif, daif jiddan (very weak) and maudu' (fabricated). Prof. Dr. Yusuf al-Qaradawi (2002) has also stated:

"I believe the reason of the widespread use of dubious hadith, munkar and fabricated among most of the speakers and preachers are opinions that say that most scholars allow the narration of weak hadith in the aspect of virtues of deeds (Fadhail al-A'mal), asceticism, encouragement and warning (al-Tarhib wa al-Tarhib), stories (al-Qasas) and the like which are not related to the Islamic law of the five verdicts of halal, haram, makruh, compulsory and voluntary".

Previously the researcher had mentioned some of the examples of famous weak and fabricated ahadith; hoping that readers' consciousness on the validity of hadith will be tremendously improved.

Misconception of the text of Ayah or Hadith

The precise understanding of an ayah or hadith also plays a significant role in the effectiveness of a motivation. Fault interpretation in understanding the highlighted issues in an ayah or a hadith may deviate the society due to the false narrations and stories that emerged. For example, verse 191 of Surah al-Baqarah:

(And remember that the savage) trial was worse than murder.

There are some of motivational speakers who interpret the word al-fitnah as defamation. Whereas when studied venerated Tafsir books, the most accurate meaning of al-fitnah is al-shirk (any form of associating Allah with partners) as if interpreted by prominent interpreters of the Qur'an like Abu 'Aliyah, Mujahid, Sa'id bin Jubair, 'Ikrimah, al-Hasan, Qatadah, al-Dahhak and al-Rabi' bin Anas (Ibn Kathir, 1999).

In a similar vein, the misconception also occurs in ahadith. For example in a renowned hadith narrated by Umar:

The Prophet said: "Surely every practice with intention and indeed one is rewarded with according to what he intended. So whoever emigrated for Allah and His Messenger, his migration (assessed) to Allah and His Apostle, and whoever emigrated for the world to be gained by him or to someone marrying a girl, then emigrated to what was to be the purpose of emigration."
(Narrated al-Bukhari 21)

It was said that this hadith has a background (Asbab al-Wurud) that is related to a famous story in which one of the Prophet's companions called Muhajir Umm Qays purposely emigrated from Makkah to Madinah to marry a woman named Umm Qays while it has been negated by Ibn Hajar al-'Asqalani (n.y) in his book Fath al-Bari.

Thus the understanding of an ayah as well as a hadith should be derived from the authentic and accurate primary sources. This is due to fact that the understanding of a hadith may not be understood simply by reason alone. Instead it should be supported with guidance from the understanding of earlier greatest generations of Salaf al-Salih and guidance of respected prominent scholars.

The Lack of Using Books of Hadith based on al-Targhib wa al-Tarhib.

Recently, there are some motivators who tend to use ahadith in preaching as well as writing books related to motivation. This is regarded as a very honorable effort yet it is advisable for the motivator to use ahadith that have been systematically arranged; as the scholars had initiated the first step in specifically and academically compiling ahadith that imply element of motivation in the books; for instance the book of *al-Targhib wa al-Tarhib* by Imam al-Mundziri, as well as the excellent efforts; seeking and compiling the authentic motivational ahadith as performed by Sheikh al-Albani via the book of *Sahih al-Targhib wa al-Tarhib*. It is highly recommended for motivators to gain as much benefit as they could from such kind of outstanding works since the number of collected ahadith in those books are numerous.

How Authentic Hadith Can Motivate Muslims & The Other Religions In Learning, Emotion & Everyday Life.

Hadith inspires Muslims and the other religions to adopt manners in learning. For instance in a well-known authentic hadith; Hadith of Jibril from Umar:

Once we were sitting in the company of Messenger of Allah when there appeared a man dressed in very white clothes and having extraordinary black hair. No signs of fatigue of journey appeared on him and he was known to none of us. He sat down facing the Prophet leaning his knees against the knees of the Prophet and placing both of his palms over his two thighs and said, "O Muhammad! Tell me about Islam". He replied, "Islam is to testify that none has the right to be worshipped but Allah, and that Muhammad is the Messenger of Allah; that you observe Salat (prayers), pay Zakat, observe Saum (fasting) of Ramadan and perform Hajj (pilgrimage) of the House, provided you have resources of making journey to it." He replied: "You have spoken the truth." We were surprised to see that he had asked him and confirmed the correctness of the answers. He then enquired: "Tell me about Iman." He said: "It is to believe in Allah, His angels, His Books, His Messengers and the Last Day and that you believe in preordainment (destiny), its bad and good consequences." He said, "You have spoken the truth." He then enquired: "Tell me about Ihsan." He said, "It is to worship Allah as if you are seeing Him; and although you do not see Him, He sees you." He enquired: "Inform me about the Hour (i.e., the Day of Resurrection)." He replied, "I have no more knowledge thereof than you". He said, "Inform me about some of its signs." He said, "They are - that a bondswoman gives birth to her own master, and that you will find the barefooted, naked, poor shepherds competing one another in the construction of higher buildings." Then he departed. The Messenger of Allah kept silent for a while then he said to me, "O 'Umar! Do you know who the questioner was?"

I replied, "Allah and His Messenger know better." The Prophet said, "He was Jibril (Gabriel); he came to you to teach you your religion." (Narrated Muslim 9/87)

This hadith exemplifies some of the substantial guiding principles regarding ethics of seeking knowledge; wearing clean and pure cloth, sitting properly and closer to the teacher, asking questions for better understanding and seeking knowledge from the right source and authority.

In addition, many hadith show the distinctive techniques used by the Prophet in raising the companions' self-esteem and motivation to change negative behavior as a result they would perform better. This includes the technique of giving reward, discouraging bad behaviors, giving praise and encouraging good behavior.

A study done by Wan Mazwati Wan Yusoff (2012) to find solutions to solve the problem of low achieving students shows that the techniques used by Prophet Muhammad to motivate his companions 1500 years ago still work in the present time. Further, the impact of these motivation techniques are apparent in the improvement of students task interest, collaborative learning, academic self-concept, self-confidence, motivation to learn, and the performance has shown an improvement as well. The results also revealed that these motivation techniques are not exclusively for Muslim students. The motivation techniques which emphasize on using only positive words and avoidance of using any negative words, criticism, reprimand, and punishment may be the contributing factors that motivate students to perform better.

Hadith also guides mankind; Muslims and non-Muslims' emotion. For example, it proposes simple and practical methods of anger management. It is worth mentioning here that Al-Bukhari had dedicated a specific chapter in Sahih Al-Bukhari concerning anger, which he titled as "To be cautious from being angry." Abu Hurairah narrated:

A man said to the Prophet: "Advise me!" The Prophet: "Do not become angry and furious." The man asked (the same) again and again, and the Prophet said in each case, "Do not become angry and furious." (Narrated al-Bukhari 6116)

The hadith reflects a great attention on avoiding the unconstructive feeling of annoyance that the Prophet kept on advising his companion to remain peaceful in harsh moments.

Another fine method of anger management recommended by the Prophet is via the saying of 'I seek Refuge with Allah from Satan' as exemplified by the hadith of Sulaiman bin Surd:

While I was sitting in the company of the Prophet, two men abused each other and the face of one of them became red with anger, and his jugular veins swelled (i.e. he became furious). On that the Prophet said, "I know a word, the saying of which will cause him to relax, if he does say it. If he says: 'I seek Refuge with Allah from Satan.' then all is anger will go away." (Narrated al-Bukhari 3040)

Most of the people consider the action of taking revenge as bravery, which in fact comes from the strong feelings of bitterness and dislike towards other person. The Prophet has nullified all such thoughts and regarded anger as one's weakness. In fact, Islam considers the one who controls himself at times of anger as attaining virtue and triumph. Abu Hurairah reported the Prophet as saying:

"The strong-man is not one who wrestles well but the strong man is one who controls himself when he is in a fit of rage." (Narrated al-Bukhari 5649)

A study done by Asadzandi et al. (2018) reveals that religious behavioral and cognitive anger management guidelines provide spiritual care that can easily be done by client in schedule of daily past oral self-care. In fact, simple, intelligible and practical religious evidence-based guidelines can be used to strengthen self-control and daily self-calculation. In addition to reducing aggression, they promote the spiritual well-being of individuals and prevent the social and psychosocial outcomes of anger.

Islam puts great emphasis on human behavior which includes attainment of good manners and positive outlook in daily routine. For instance, Abu Shuraih narrated:

The Prophet said, "By Allah, he does not believe! By Allah, he does not believe! By Allah, he does not believe!" It was said, "Who is that, O Allah's Apostle?" He said, "That person whose neighbor does not feel safe from his evil."
(Narrated al-Bukhari 8/45)

The bond of fraternity among the Muslims has been further strengthened by the gist of this hadith about the right of neighbors. Muslims are ordained to treat them nicely. Nice treatment to them is the best means to avoid from the warning that is clearly mentioned in the hadith, that it is one sign of disbelief. In other words, those who lack this quality only expose their weak and imperfect faith.

Ibn 'Abbas narrated that Allah's Apostle passed by two graves and said, "Both of them (persons in the grave) are being tortured, and they are not being tortured for a major sin. This one used not to save himself from being soiled with his urine, and the other used to go about with calumnies (among the people to rouse hostilities, e.g., one goes to a person and tells him that so-and-so says about him such-and-such evil things). The Prophet then asked for a green leaf of a date-palm tree, split it into two pieces and planted one on each grave and said, "It is hoped that their punishment may be abated till those two pieces of the leaf get dried." (Narrated al-Bukhari 8/78)

Cleanliness is a part of faith. This hadith emphasizes the importance of hygiene in our daily life. It indicates that one will be tortured in the grave even he just not being hygiene during urine. This hadith also mentions another type of sin that can cause the torment in the grave; that is to spread hostilities, hatred and disputes among people in the society. Hudhaifah said: I heard the Prophet saying, "A Qattat will not enter Paradise." (Narrated al-Bukhari 8/82)

According to this hadith a qattat or a person who conveys information from one person to another with the intention of causing harm and enmity between them will be barred from entering Jannah. May Allah guide us to promote goodness, love and mercy among people, and strengthen us to bridge the gap among them, rather than widening it more and more. Abu Hurairah narrated: The Prophet said,

"Whoever does not give up false statements (i.e. telling lies), and evil deeds, and speaking bad words to others, Allah is not in need of his (fasting) leaving his food and drink." (Narrated al-Bukhari 8/83)

The point which becomes evident from this hadith is that honesty is the best policy in every speech. In other words, in every word, one should say the truth, rather than telling lies, otherwise, Allah will reject one's good deeds.

POTENTIAL WONDERS

The life of Prophet is the model for the whole humankind, Muslims and other religions. In the light of Divine Message, he guided the humankind in every aspect of life. The Prophet was qualified with all the excellent qualities of head and heart described in the Quran supplemented with the hadith that motivated and enjoined upon Muslims and other religions good manners

for every occasion starting from seeking permission, greeting, sitting, eating, talking, learning, teaching, sporting, traveling, dressing, visiting, sleeping and marriage to treating people, particularly relatives and neighbors with kindness. The research bases on the authentic motivational ahadith particularly that are related to the concept of positive and negative reinforcement and punishment make the people active in persuading and what sort of rewards and punishments were mentioned that motivate the humankind to do good deeds and stay away from negative behaviors. The techniques used by Prophet to motivate his companions 1500 years ago still effective and relevant in the present time.

CONCLUSION

The present study was embarked to identify some issues in the use of hadith related to motivation. The researchers found that there are five most significant issues in the use of hadith related to motivation which are the lack of stating the validity of hadith, the existence of hadith daif (weak) and maudu' (fabricated), the misconception of the text of ayah or hadith and the influence of hadith masyhur and the lack of using books of hadith based onal-Targhib wa al-Tarhib. This study implies that the techniques of reward and punishment based on authentic hadith can be one of the finest solution in motivation. In addition, the understanding of the hadith should be also derived from the authentic and accurate primary sources. The study also revealed that these motivation techniques are suitable for Muslims and other religions as revealed by Wan Mazwati Wan Yusoff (2012). Further research on motivation based on authentic hadith should be conducted on a larger scale including the biological, emotional, social, and cognitive aspects to test the robustness of these motivation techniques.

REFERENCES

- Al-Quran al-Karim
Abdullah al-Qari bin Haji Salleh, *40 Hadis Motivasi Ilmu*, (Batu Caves:Edusystem Sdn. Bhd, 2006). (In Malay).
- Al-'Ajluni, Isma'il Bin Muhammad al-'Ajluni al-Jarahi, *Kashf al-Khafa' wa Muzil al-Ilbas 'amma Ishtuhira min al-Ahadith 'ala Alsinah al-Nas*, (n.p: Dar al-Kutub al-'Ilmiyyah, n.d).(In Arabic).
- Anon, 2012M (21 Februari). Penyebaran Hadis Palsu Bahaya, Mengelirukan. *BeritaHarian - Nasional*. Kuala Lumpur.(In Malay).
- Al-Albani, Muhammad Nasiruddin, *Silsilah al-Ahadith al-Dha'ifah wa al-Maudhu'ah*, (Beirut: al-Maktab al-Islami, vol. 5, 1985), 6, 1/189-191.(In Arabic).
- Asadzandi M, Eskandari AR, Khadem Al-Hosayni M and Ebadi A, "Religious Evidence-Based Spiritual Self-Care Guidelines in Anger Management", *Journal of Health Education Research & Development*, (2018).
- Asilah Abu Bakar. 2011M. *Motivasi Dalam Firman dan Sabda Aplikasi Generasi Terawal Sebagai Mentor Kepada Generasi Masa Kini: Kajian Khusus Terhadap Persaudaraan dan Berpegang Teguh Kepada Kebenaran*. JPQS/FPI. Bangi: Universiti Kebangsaan Malaysia.(In Malay).
- Al-Baihaqi, Abu Bakr Ahmad Bin al-Husain, *Shu'b al-Iman*, Edited by Muhammad al-Sa'id Basyuni Zaghlul, (Beirut: Dar al-Kutub al-'Ilmiyyah, 1990).(In Arabic).
- Al-Bukhari, Muhammad bin Isma'il. 1417H/1997M. *Sahih al-Bukhari* Edited by Muhammad bin 'Ali al-Qutb, Hisham al-Bukhari. vol. 1-5. Beirut: al-Maktabah al-'Asariyyah.(In Arabic).
- Al-Daruqutni, 'Ali Bin 'Umar Abu al-Hasan al-Daruqutni al-Baghdadi, *al-'Ilal*, Edited by: Mahfuz al-Rahman Zain Allah al-Salafi, (al-Riyad: Dar Tayyibah, 1985).(In Arabic).

- Al-Dhahabi, Shamsuddin Bin Muhammad Bin Ahmad, *Mizan Al-I'tidal fi Naqd al-Rijal*, Edited by: 'Ali Bin Muhammad Mu'awwad and 'Adil Ahmad 'Abd al-Maujud, (Beirut: Dar al-Kutub al-'Ilmiyyah, 1995). *(In Arabic)*.
- Al-Dhahabi, Shamsuddin Bin Muhammad Bin Ahmad, *Siyar A'lam al-Nubala'*, Edited by: Shuaib al-Arnaut and Muhammad Nuaim al-'Arqasusi, (Beirut: Muassasat al-Risalah, vol. 9, 1993). *(In Arabic)*.
- Deansama. 2007M (September 15). *Forum Petua Mendapat Pasangan 06/14*. Youtube: http://www.youtube.com/watch?v=IzIdPf_UlvQ. [21 Jun 2012]. *(In Malay)*.
- Farah Shahidah Mohamed. 2011M. *Motivasi Dalam Firman dan Sabda Aplikasi Generasi Terawal Sebagai Mentor Kepada Generasi Masa Kini: Kajian Khusus Terhadap Maruah dan Taubat*. JPQS/FPI. Bangi: Universiti Kebangsaan Malaysia. *(In Malay)*.
- Al- Haithami, 'Ali Bin Abi Bakr Bin Sulaiman Bin Abi Bakr Bin 'Umar Bin Salih al-Misri, *Majma' al-Zawaid*, (Beirut: Dar al-Rayyan liAL-Turath wa Dar al-Kitab al-'Arabi, 1987). *(In Arabic)*.
- Ibn Hajar al-'Asqalani, Ahamad Bin 'Ali Ibn Hajar Abu al-Fadl, *al-Talkhis al-Habir*, Edited by Al-Sayyid 'Abdullah Hashim al-Yamani al-Madani, (al-Madinah: n.p, 1694). *(In Arabic)*.
- Ibn Hajar al-'Asqalani, Ahmad Bin 'Ali Abu al-Fadl, *Lisan al-Mizan*, Edited by: Dar al-Maa'rif al-Nazzamiyyah-al-Hind, (Beirut: Muassasat al-A'lami li al-Matbu'at, vol.3, 1986). *(In Arabic)*.
- Ibn Hajar al-'Asqalani, Ahmad Bin 'Ali Abu al-Fadl, *Taqrib al-Tahdhib*, Edited by: Muhammad 'Awwamah, (Syria: Dar al-Rashid, 1986). *(In Arabic)*.
- Ibn Hajar al-'Asqalani, Ahmad Bin 'Ali Abu al-Fadl, *Fath al-Bari*, Edited by: Muhammad Fuad 'Abd al-Baqi and Muhib al-Din al-Khatib, (Beirut: Dar al-Ma'rifah, 1959). *(In Arabic)*.
- Al- Hakim, Abu 'Abdullah al-Hakim, Muhammad Bin Abdullah al-Naisaburi, *al-Mustadrak 'ala al-Sahihain*, Edited by: Mustafa 'Abdul Qadir 'Ata, (Beirut: Dar al-Kutub al-'Ilmiyyah, 1990). *(In Arabic)*.
- Ibn 'Iraq, Abu al-Hasan 'Ali Bin Muhammad Bin 'Iraq al-Kinani, *Tanzih al-Shari'ah 'an al-Ahadith al-Shani'ah al-Maudhu'ah*, Edited by: 'Abd al-Wahhab 'Abd al-Latif and 'Abdullah Muhammad al-Siddiq, (Beirut: Dar al-Kutub al-'Ilmiyyah, vol. 2, 1981). *(In Arabic)*.
- Ibn al-Jawzi, Abu al-Farj Abd al-Rahman Bin 'Ali, *Kitab al-Maudhu'at*, Edited by: 'Abd al-Rahman Muhammad Uthman, (n.p, Dar al-Fikr, vol. 2, 1983). *(In Arabic)*.
- Ibnu al-Jawzi, Abu al-Farj 'Abd al-Rahman Bin 'Ali, *al-'Ilal al-Mutanahiyah*, Edited by: Khalil al-Mis, (Beirut: Dar al-Kutub al-'Ilmiyyah, 1983). *(In Arabic)*.
- Al-Jurjani, Abdullah Bin 'Adi Bin Abdullah Bin Muhammad Abu Ahmad, *al-Kamil fi Du'afa' al-Rijal*, Edited by: Yahya Mukhtar Ghazawi, (Beirut: Dar al-Fikr, vol. 3, 1988). *(In Arabic)*.
- Ibn Kathir, Abu al-Fida' Isma'il bin 'Umar bin Kathir al-Qurashi al-Dimashqi, *Tafsir al-Qur'an al-'Azim*, Edited by Sami bin Muhammad Salamah, (n.p: Dar Tayyibah li al-Nashr wa al-Tawzi', 1999). *(In Arabic)*.
- Al-Khatib al-Baghdadi, Ahmad Bin 'Ali Bin Thabit Abu Bakr, *al-Rihlah fi Talab al-Hadith*, Edited by: Nur al-Din 'Itr, (Beirut: Dar al-Kutub al-'Ilmiyyah, 1975). *(In Arabic)*.
- Manna' al-Qattan. 1422H/2001M. *Mabahith fi 'Ulum al-Hadith*. Al-Qahirah: Maktabah Wahbah. *(In Arabic)*.
- Mariam Mohamed. 2004M. *Kajian Hadis Dalam Khutbah Jumaat Jabatan Agama Islam Sarawak (JAIS)*. Bangi: Universiti Kebangsaan Malaysia. *(In Malay)*.

- Mienfitri. 2008M (September 22). *Penawar Hati 2 – Rangsang Perubahan(AstroOasis)*. Youtube:<http://www.youtube.com/watch?v=m614vXM6fAg>. [21 Jun2012](*In Malay*).
- Mohamad Hasbullah Salim & Mohd Aizul Yaakob. 2011M. *Penggunaan Hadith Da'ifDi Dalam Aspek al-Targhib wa al-Tarhib: Kajian Terhadap Kitab Lubab al-Hadith Karya Sheikh Abu Bakar Palestin*. Dlm. *Sunnah Nabi: Realiti dan Cabaran Semasa*, 543-556. Seminar Antarabangsa Sunnah Nabawiah:Realiti dan Cabaran Semasa (MUSNAD). [12 & 13 Julai 2011]. Kuala Lumpur: Universiti Malaya.(*In Malay*).
- Mohd. Fadzilah Kamsah (Dato' Dr.), Muhammad Zakaria. 2005M. *Kemahiran Mendidik Anak - 21 Kaedah Mendidik Anak Cemerlang*. Kuala Lumpur:Telaga Biru Sdn. Bhd.(*In Malay*).
- Mohd. Fadzilah Kamsah (Dato' Dr.), Muhammad Zakaria, Maheran Makhtar. 2006M. *Kemahiran Mendidik Anak – Menangani Anak Bermasalah*. Kuala Lumpur: Telaga Biru Sdn. Bhd.(*In Malay*).
- Mohd. Fadzilah Kamsah (Dato' Dr.), Muhammad Zakaria, Husna Hassan. 2007M. *Petua Mendidik Anak Menjadi Insan Positif*. Kuala Lumpur: Telaga Biru Sdn. Bhd.(*In Malay*).
- Mohd. Khairul Nizam (Dr). 2012M. *Motivasi Gaya Rasulullah*. Batu Caves: PTS Millennia Sdn. Bhd.(*In Malay*).
- Al-Mubarakfuri, Muhammad 'Abd al-Rahman Bin 'Abd al-Rahim al-Mubarakfuri, Abu al-'Ala, *Tuhfat al-Ahwadhi*, (Beirut: Dar al-Kutub al-'Ilmiyyah, n.d). (*In Arabic*).
- Mulla al-Qari', Nur al-Din 'Ali Bin Muhammad Bin Sultan, *al-Maudhu'at al-Kubra*, Edited by: Abu Hajar Muhammad al-Sa'id Bin Basyuni Zaghlul, (Beirut: Dar al-Kutub al-'Ilmiyyah, 1985).(In Arabic).
- Mulla al-Qari', Nur al-Din 'Ali Bin Muhammad Bin Sultan, *al-Masnu'*, Edited by: 'Abd al-Fattah Abu Ghuddah, (al-Riyad: Maktabah al-Rushd, 1984), 91/1, no.106.(*In Arabic*).
- Al-Munawi, Muhammad 'Abd al-Rauf, *Faid al-Qadir Sharh al-Jami'al-Saghir*, (Misr: al-Maktabah al-Tijariyyah al-Kubra,vol. 1, 1936). (*In Arabic*).
- Al-Mundhiri, Zaki al-Din 'Abd al-'Azim Bin 'Abd al-Qawi,*al-Targhib wa al-Tarhib*, Edited by: Ibrahim Shams al-Din, (Beirut: Dar al-Kutub al-'Ilmiyyah, 1997).(In Arabic).
- Al-Mundhiri, Zaki al-Din 'Abd al-'Azim Bin 'Abd al-Qawiy, *al-Targhib wa la-Tarhib*, Edited by: Ibrahim Shams al-Din,(Beirut: Dar al-Kutub al-'Ilmiyyah, 1997).(In Arabic).
- Abu Nu'aim, Ahmad Bin 'Abdullah al-Asbahani, *Hilyah al-Auliya'*, (Beirut: Dar al-Kitab al-'Arabi, 1985).(In Arabic).
- Ibn Qayyim al-Jawziyyah, Muhammad Bin Abi Bakr, *Al-Manar al-Munif fi al-Sahih wa al-Dhaif*, Edited by: 'Abd al-Fattah Abu Ghuddah, (Halb: Maktabah al-Matbu'at al-Islamiyyah, vol.2, 1982).(In Arabic).
- Al- Sakhawi, Shamsuddin Muhammad Bin 'Abd al-Rahman, *al- Maqasid al-Hasanah fi Bayan Kathir min al-Ahadith al-Mushtahirah 'ala al-Asinah*, Edited by 'Abdullah Muhammad al-Siddiq, (Beirut: Dar al-Kutub al-'Ilmiyyah, 1987).(In Arabic).
- Salwa Hussin. 2011M. *Peranan Motivasi Dalam Pembentukan Kepimpinan Mahasiswa: Pandangan Mahasiswa FPI,UKM*. JPDK/FPI.Bangi: Universiti Kebangsaan Malaysia.(*In Malay*).
- Al-Shawkani, Muhammad Bin 'Ali, *al-Fawaid al-Majmu'ah fi al-Ahadith al-Maudhu'ah*, Edited by 'Abd al-Rahman Bin Yahya al-Mu'allimi al-Yamani, Beirut: n.p, 1972).(In Arabic).
- Siti Hajar Salwa Ahmad Musadik, Ilhaamie Abdul Ghani Azmi, "A Conceptual Paper: The Effect Of Islamic Religiosity On Impulse Buying Behavior", *Journal of Global Business and Social Entrepreneurship (GBSE)*, (2017).(In English).

- Al-Suyuti, Jalal al-Din Abd al-Rahman, *al-Laali' al-Masnu'ah fi al-Ahadith al-Maudhu'ah*, (Beirut: Dar al-Ma'rifah, n.p, n.d).*(In Arabic)*.
- Ibn Tahir al- Maqdisi, Abu al-Fadl Muhammad Bin Tahir Bin Ahmad al-Maqdisi, *Tadhkirat al-Maudhu'at*, Edited by: Muhammad Mustafa al-Hadri al-Habti, (Makkah: Maktabat wa Matba'at al-Nahdah al-Hadithiyyah, 1981).*(In Arabic)*.
- Ibn Taymiyyah, Ahmad bin 'Abd al-Halim al-Harani Abu al-'Abbas, *Majmu' al Fatawa*, edited by Anwar al-Baz 'Amir al-Hazar, (n.p.: Dar al-Wafa', 3rd edn., 2005).*(In Arabic)*.
- Ibn Taimiyyah, Ahmad Bin 'Abd al-Halim al-Hirani Abu al-'Abbas, *al-Ahadith al-Maudhu'ah*, Edited by: Mahmud al-Arnaut (Kuwait: Maktabah Dar al-Ma'rifah li al-Nashr wa al-Tawzi', 1988).*(In Arabic)*.
- Ibn Taimiyyah, Ahmad Bin 'Abd al-Halim al-Hirani Abu al-'Abbas, *al-Ahadith al-Da'ifah wa al-Batilah*, Edited by: Majdi Fathi al-Sayyid, (n.p: Dar al-Sahabah li al-Turath, 1989).*(In Arabic)*.
- Al-Tirmidhi, Muhammad Bin 'Isa Bin Surah, *al-Sunan*, Edited by: Ahmad Shakir and others, (al-Qahirah: Mustafa al-Babi al-Halabi, 1937).*(In Arabic)*.
- Al-'Uqaili, Abu Ja'far Muhammad Bin 'Umar Bin Musa, *al-Du'afa' al-Kabir*, Edited by: 'Abd al-Mu'ti Amin Qal'aji, (Beirut: Dar al-Kutub al-'Ilmiyyah, 1984).*(In Arabic)*.
- Wan Mazwati Wan Yusoff, "The Impact of Prophet Muhammad Motivation Techniques on Students' Performance", *Social and Behavioral Sciences*, (2012).*(In English)*.
- Yusuf al-Qaraqawi (Prof. Dr.). 2002M. *Kaifa Nata'amul Ma'a al-Sunnah*. Kaherah: Dar al-Shuruq.*(In Arabic)*.
- Zaenuri Rofi'in, "The implementation of Islamic Education in shaping tolerant characters in multicultural perspective", *Journal of Islamic Culture and Education*", (2018).*(In English)*.

Systematic Literature Review: Communication Anxiety in Students

Nur Fitriyana
Universitas Muhammadiyah Riau
nurfitriyana@umri.ac.id

Yohan Kurniawan
Universiti Malaysia Kelantan
yohan@umk.edu.my

ABSTRACT

The ability to communicate effectively is needed by every individual, especially for a candidate for the nation's successor, namely students. Good communication skills are an important capital in the process of disseminating information, knowledge and supporting the learning process on campus, especially in expressing ideas to others. This research was conducted to see how communication anxiety in college students. This study uses a systematic literature review technique by searching for published articles that match the theme on Google Scholar and the DOAJ portal for the last 10 years (2011-2022) with the keyword "communication anxiety among students". The selected articles are the results of research conducted in Indonesia. Found 9 articles that match the criteria after the screening process. Broadly speaking, communication anxiety in students is found in both academic and non-academic activities. Based on the results of a study of several literatures, in general communication anxiety arises from internal and external students.

Keywords: *Anxiety, Communication, Students*

INTRODUCTION

The ability to communicate effectively is needed by every individual, especially for a candidate for the nation's successor, namely students. Good communication skills are an important capital in the process of disseminating information, knowledge and supporting the learning process on campus, especially in expressing ideas to others. Unlike the case when sitting in school, in higher education a student is required to be able to play a more active role in the teaching and learning process and to be more independent in finding lecture information. Therefore, students who have just entered the campus world must be able to adapt to the patterns that exist on campus.

Adapting in question is how students are able to adapt themselves to teaching staff (lecturers), the learning system, and most importantly how students are able to adjust the way they communicate with teaching staff and friends on campus. Based on observations in the Indonesian Islamic University campus environment, there are various students who come from outside the city of Yogyakarta, such as from the islands of Java, Kalimantan, Sumatra, Sulawesi, and several other islands, so this allows for very different word structures and pronunciations. differ from one region to another. Therefore, as new students they must be able to adjust themselves to the new friends around them in order to create good and effective communication.

Communication acts as a vessel for expressing ideas and ideas in order to relate to other people. Rakhmat (2012) added that by communicating humans can learn many things, build relationships with other people and preserve civilization. In the world of education, communication plays a very important role to support the spread of knowledge. For example,

through oral and written communication, lecturers and scientists can share their knowledge and experiences with students to study and review. In addition, students are also expected to be able to express their ideas and ideas in order to advance science and their nation. To express these ideas and ideas, good communication skills are needed.

Researchers conducted an initial survey regarding Communication Anxiety (Greenberg Padesky, 2004) to 10 new students, the results of which were 7 out of 10 new students had a very high level of communication anxiety (1) and High (5) people. This indicates that the level of anxiety in communicating new students is at a high level.

A study in America states that 10-20% of American students suffer from communication anxiety (McCroskey, 1978). People who experience this try to communicate as little as possible due to anxiety, including the fear of receiving negative responses or judgments from the communicant or person receiving the message.

METHOD

This study used a systematic literature review (SLR) method. This method can be interpreted as a method that is systematic, clear, thorough, and reproducible, for identifying, evaluating, and synthesizing a collection of works that have been produced by previous researchers (Okoli & Schabram, 2010). This method has been widely used and is quite popular in research (Cabassa et al. 2017; Calati et al., 2021; Klettke, Hallford, & Mellor, 2014; Mills et al., 2020; Rogers et al., 2021).

The systematic review study or systematic literature review that will be carried out refers to the guidelines for conducting systematic reviews using PRISMA (Preferred Reporting Items for Systematic Reviews and Meta-analyses) (Liberati et al., 2009).

The literature that is the reference material in this study is the results of research conducted in Indonesia with the theme of communication anxiety in students from 2011 to 2022. Literature sources based on the keywords described above were traced using scientific data search guidelines through Google Scholar and DOAJ, then stored in the Mendeley software.

Based on the search results in the database that the researchers used, there are around 19,400 publications that use the word "communication anxiety in students" either in the written title, abstract, or article content. This happens because Google scholar is an internet database that collects a lot of writing, not only journal articles, but also books, reports, essays and others from various disciplines, therefore the researcher reduces the search results that have been done by provide selection criteria. Selection criteria: 1) Research discussing communication anxiety in students, 2) articles originating from scientific journal publications, 3) articles accessible and containing clear information, 4) articles written in Indonesian and conducted in Indonesia. Then the researcher reads the title and abstract of the literature to find out whether the article meets the criteria for review.

RESULT

After the screening and screening stages of the literature, the researcher formulates a categorization of the screening results. This screening stage is the result and discussion which

is the focus of a systematic literature review article. The results of literature screening can be seen in table below.

Table 1. Literature Result

No	Researchers	Variable	Participant	Result
1	Asti Puspitasari Gaspersz, 2022	Self-Concept and Interpersonal Communication Anxiety	150 Students of the Teaching and Education Faculty of Pattimura University, Ambon.	Based on the results of data analysis using the Rho Spearman and Tau Kendall correlation techniques, the results obtained were a self- concept score of $r_{xy}=0.544$ and an interpersonal communication anxiety score of $r_{xy}=0.354$. positive relationship between self-concept and interpersonal communication anxiety in students of the Teaching and Education Faculty. So it can be interpreted that the higher the self- concept, the lower the anxiety of interpersonal communication, but conversely, the lower the self-concept, the higher the anxiety of interpersonal communication that will appear.
2	Nurul Huda, Basuki dan Sigit Tripambudi, 2009	Self-Control and Interpersonal Communication Anxiety	There are 41 tour guides who are members of the HPI (Yogyakarta Prabuwisata Association).	The results of this analysis indicate that interpersonal communication anxiety among tour guides in Yogyakarta is very low and the majority of tour guides in Yogyakarta have high self-control. 50% of respondents have a very good ability to anticipate events.
3	Eko Mulyadi, 2020	Coping Mechanisms and Anxiety Interpersonal Communication	There are 77 students of the Nursing Professional	Based on the research results and descriptive and inferential statistical tests, it can be concluded that

			Study Program, Faculty of Health Sciences, Wiraraja University, Sumenep.	there is a relationship between individual coping mechanisms and interpersonal communication anxiety in Nursing students. Most respondents have adaptive coping mechanisms and most respondents experience interpersonal communication anxiety with mild anxiety category.
4	Yeni Anggraini, Auliya Syaf, Adri Murni, 2017	Positive Thinking and Communication Anxiety	There are 127 students from the Faculty of Psychology at Abdurab University, Pekanbaru.	Based on the research results, it can be seen that there is a relationship between positive thinking and communication anxiety, the correlation coefficient is -0.641 with p 0.000 (p <0.05). This shows that there is a significant relationship between positive thinking and communication anxiety in the direction of a negative relationship, which means that the higher the positive thinking, the lower the communication anxiety for Abdurab University students in Pekanbaru and vice versa, the lower the positive thinking, the higher the communication anxiety for Abdurab University students. Pekanbaru.
5	Yohanes Wendelinus Dasor, 2017	Learning Effectiveness and Anxiety	Learners	The student centered learning method is believed to be able to foster individual character who is not anxious about communicating, has a self-concept that believes in the ability to communicate and has

				adequate competence in aspects of communication.
6	Khoirul Muslimin, 2020	Anxiety	Jepara Inisnu students.	The anxiety of communicating in public that students experience is influenced by feelings of being evaluated. This shows that the feeling of being evaluated by students at the da'wah faculty causes anxiety to communicate.
7	Ficky Dewi Andieni dan Wiryo Nuriono, 2020	Narrative Counseling and Anxiety	There are 5 students of class VIII SMPN 40 Surabaya who experience high communication anxiety.	The conclusion of this study is that the application of narrative counseling can reduce students' communication anxiety which is marked by the appearance of actions that protest their anxiety, new understandings about anxiety, rearrangement of new stories outside of aspects of anxiety and new performance for communicating. This means that the application of narrative counseling can reduce students' communication anxiety.
8	Noviana Dewi dan Stefanus Khrimasagung Trikusumaadi, 2016	Addiction, Anxiety, and the Cooperative Character	90 student	Based on the results of data analysis, it can be concluded that internet addiction and communication anxiety both jointly and partially affect the character of student cooperation.
9	Dea Melli Ridwan	Anxiety	Papua and West Papua students at Syiah Kuala University who have lived for	Based on the results of this study, the researchers concluded that related to research questions and problems, that Papuan students who were

			at least 12 months in Banda Aceh are 7 people.	informants in this study had adapted well to their environment, they had gone through a phase of anxiety in the role of intercultural communication they were currently living.
--	--	--	------------------------------------------------	---------------------------------------------------------------------------------------------------------------------------------------------------------------------------------

In the first research literature from Astri Puspitasari (2020) it was found that there was a positive relationship between self-concept and interpersonal communication anxiety among students in the Teaching and Education Faculty. So it can be interpreted that the higher the self-concept, the lower the anxiety of interpersonal communication, but conversely, the lower the self-concept, the higher the anxiety of interpersonal communication that will appear. Research on self-control and communication anxiety from Nurul Huda (2009) explains that interpersonal communication anxiety among tour guides in Yogyakarta is very low and the majority of tour guides in Yogyakarta have high self-control. 50% of respondents have a very good ability to anticipate events.

Based on research on coping with communication anxiety, Eko Mulyadi's research (2020) explains that there is a relationship between individual coping mechanisms and interpersonal communication anxiety in Nursing students. Most respondents have adaptive coping mechanisms and most respondents experience interpersonal communication anxiety in the mild anxiety category. This is also supported by another way, namely positive thinking from Yeni's research (2017) explaining that there is a relationship between positive thinking and communication anxiety, the correlation coefficient is -0.641 with $p < 0.000$ ($p < 0.05$). This shows that there is a significant relationship between positive thinking and communication anxiety in the direction of a negative relationship, which means that the higher the positive thinking, the lower the communication anxiety for Abdurrah University students in Pekanbaru and vice versa, the lower the positive thinking, the higher the communication anxiety for Abdurrah University students. Pekanbaru.

Research from Khoirul (2020) explains that the anxiety of communicating in public experienced by students is influenced by feelings of being evaluated. This shows that the feeling of being evaluated by students at the da'wah faculty causes anxiety to communicate.

CONCLUSION

Based on the results of a study of several literatures, in general communication anxiety arises from internal and external students. The internal factors arise from beliefs that are still less stable. Lack of self-control management is the main internal factor that students feel. Several approaches in reducing communication anxiety have proven to be very effective in reducing communication anxiety in students.

REFERENCES

- Andieni, V. D., & Nuryono, W. (2016). Penerapan Konseling Naratif untuk Mereduksi Kecemasan Komunikasi (Communication Apprehension) pada Siswa Kelas VIII di SMPN 40 Surabaya. *Mahasiswa Bimbingan Dan Konseling PENERAPAN*, 1-11.

- Dasor, Y. W. (2017). Efektivitas Pembelajaran Berbasis Student Centered Learning dalam Mengatasi Kecemasan Komunikasi. *JIPD (Jurnal Inovasi Pendidikan Dasar)*, 1(1), 85-100.
- Dewi, N., & Trikusumaadi, S. K. (2017). Bahaya kecanduan internet dan kecemasan komunikasi terhadap karakter kerja sama pada mahasiswa. *Jurnal Psikologi*, 43(3), 220-230.
- Gaspersz, A. P. (2022). Konsep diri dan kecemasan komunikasi interpersonal pada mahasiswa. *INNER: Journal of Psychological Research*, 2(1), 67-74.
- Gunarsa, Singgih & Gunarsa, Yulia. (2001). *Psikologi Praktis Anak, Remaja dan Keluarga*. Jakarta: Gunung Mulia.
- Hartaji, Damar A. (2012). Motivasi Berprestasi Pada Mahasiswa yang Berkuliah Dengan Jurusan Pilihan Orangtua. Jawa Barat; Fakultas Psikologi Universitas Gunadarma. (tidak diterbitkan)
- Hasbi, F. F. (2016). Efektivitas Pelatihan Efikasi Diri Akademik untuk Menurunkan Kecemasan Akademik pada Siswa Akselerasi. *Thesis*. Universitas Islam Indonesia.
- Huda, N., Basuki, B., & Pambudi, S. T. (2014). Kontrol Diri dan Kecemasan Komunikasi Interpersonal Pada Pramuwisata. *Jurnal Ilmu Komunikasi*, 7(2), 171-182.
- Irwansya. (2008). Hubungan antara Kecemasan komunikasi, Cellophone Apprehension, Usability dan Motif Komunikasi Interpersonal pada Pengguna Telepon Genggam . *Thesis*. Jakarta; Universitas Indonesia: Tidak diterbitkan.
- Kartono, K., & Gulo, D. (2003). *Kamus Psikologi*. Bandung: Pionir Jaya Press
- Lazarus, R.S. 1976. *Patterns of Adjustment*, Tokyo: McGraw-Hill, Kogakusha, Ltd.
- Lailatushifah, S. N. F. 2004. Peran Efikasi Diri, Optimisme, Dukungan Dosen Pembimbing, terhadap Stres Mahasiswa yang Sedang Menyusun Skripsi. *Tesis*. Fakultas Psikologi UGM. Tidak diterbitkan
- Littlejohn, L., & Foss, K. (2011). *Teori Komunikasi* (Vol. Edisi 9). Jakarta: Salemba Humanika.
- Mulyadi, E., & Hidayat, S. (2014). Hubungan mekanisme koping individu dengan kecemasan komunikasi interpersonal pada mahasiswa ners. *Wiraraja Medika: Jurnal Kesehatan*, 4(2), 54-59.
- Muslimin, K. (2013). Faktor-faktor yang memengaruhi kecemasan berkomunikasi di depan umum (Kasus mahasiswa Fakultas Dakwah INISNU Jepara). *Interaksi: Jurnal Ilmu Komunikasi*, 2(2), 145-155.
- Myers, A and Hansen, C. (2002). *Experimental Psychology* 5th edition. USA: Wadsworth Group.
- McCroskey, James C. 1984. *Avoiding Communication: Shyness, Reticence, and Kecemasan komunikasi*. New York: Sage Publication, Inc.
- Ridwan, D. M. (2021). PENGELOLAAN KECEMASAN DALAM KOMUNIKASI ANTARBUDAYA PADA MAHASISWA PAPUA DI UNSYIAH. *Jurnal Ilmiah Mahasiswa Fakultas Ilmu Sosial & Ilmu Politik*, 6(2).
- Syaf, A., Anggraini, Y., & Murni, A. (2017). Hubungan antara berpikir positif dengan kecemasan komunikasi pada mahasiswa. *Psychopolytan: Jurnal Psikologi*, 1(1), 31-38.

Assessment of The Role of Safety Management Attitudes Towards Safety Compliance Among Construction Contractors

Nik Fadhilah Nik Him
Universiti Sultan Zainal Abidin
nikfadhiey@gmail.com

Noor Aina Amirah
Universiti Sultan Zainal Abidin
ainaamirah@unisza.edu.my

Siti Khatijah Yasin
Universiti Sultan Zainal Abidin
sitikhatijahy@yahoo.com

Nurhazilah Mamat
Universiti Malaysia Terengganu
gsk2591@pps.umt.edu.my

ABSTRACT

Occupational safety and health management is an important factor in ensuring that workplace safety is safe. The attitude of safety management towards occupational safety and health management in the construction industry is still weak and this affects the level of safety compliance at construction sites. This study aims to evaluate the level of safety management attitude which consists of management commitment, safety training, safety communication, safety procedures, and risk management. This study uses a quantitative method which is through the distribution of questionnaires to 376 project managers in the data collection process. To measure the level of safety management attitudes among construction contractors, the research's findings will be assessed using descriptive analysis and discussed in the form of frequency tables, percentages, and mean scores. The study's findings demonstrate that, when compared to other components, management commitment practices have the highest mean score value. In conclusion, it is proven that management commitment is important for the management of OSH at construction sites. This is important to ensure that management commitment helps improve OSH policies on construction sites to ensure that workplace conditions are always safe.

Keywords: *Occupational Safety and Health Management, Safety Management Attitude, Construction Industry*

INTRODUCTION

Occupational Safety and Health (OSH) practices are an important component of the construction sector. This is because the construction sector is one of the sectors that contributes the most in cases of occupational accidents (Oswald et al., 2018). Workplaces on construction sites are at risk of inviting occupational accidents that affect the productivity of construction projects. The accident affected the image of the construction industry which contributes to the national economy. Therefore, occupational safety related practices are an important element for construction firms and workers to ensure occupational safety (Zailani, Abubakar & Ibrahim, 2021; Arifin et al., 2021).

Safety assurance in the construction sector requires the commitment of all parties to ensure the highest level of safety (Basahel, 2021). This commitment involves the practice of safety compliance, management commitment, safety training, safety communication, safety procedures, and risk management. Through this practice, safety management will become more systematic because there is a high commitment from construction contractors to implement and plan safety management efficiently (Shafique & Rafiq, 2019; Yiu, Sze & Chan, 2018). Therefore, emphasis on PPE practices is important to create an empty construction sector.

Concerning the importance of safety management practices in the construction sector, this study was conducted to assess the level of safety management attitudes among construction contractors. This study can be a guide to continuously improve the safety aspects of the construction sector.

LITERATURE REVIEW

Safety Compliance

Safety compliance refers to safety attitude in the workplace (Basahel, 2021). According to Subramaniam et al., (2016), safety compliance is a requirement for the implementation of actions by individuals to ensure safety in the workplace. This refers to voluntary or natural behaviour to improve aspects of safety that raise safety concerns, and a willingness to suggest improvements to safety regulations in the workplace (Haas & Porio, 2022). In order to increase the level of safety compliance, the behavioural component is the main factor to implementation actions by maintaining the standard of safety regulations at the construction site.

Management Commitment

The degree to which management is considered to place a high premium on safety, and to communicate and act on safety issues effectively is the definition of management commitment to safety (Mashi, Subramaniam & Johari, 2020). Management commitment is the responsibility or concern shown by top management for the importance of safety, awareness of safety practices, safety inspections, provision of use of safety equipment and how management emphasizes the importance of safety practices to employees (Petitta et al., 2017; McGonagle et al., 2016).

Safety Training

Training is a form of knowledge required to improve skills or behaviour to perform a task (Loosemore & Malouf, 2019). According to Martinez, Gheisari and Alarcon (2013), safety training is a process for employees to acquire good skills, knowledge and attitudes. This is not only for employee needs but also important for competition and organizational performance. Therefore, in forming a safe work culture, the contractor needs to provide specific training to new employees to ensure that the level of safety in the construction sector is always under control (Demirkesen & Arditi, 2015).

Safety Communication

Communication has described as the process of conveying information between two parties to influence a person's behaviour (Newnam & Goode, 2019). Communication is the need to communicate information and express thoughts to each other. According to Mashi et al., (2020), safety communication is a requirement for an organization to actively involve itself in

forming a safe work culture. This line with the importance of safety communication which acts as a process of giving and receiving safety information on construction sites (Haas & Yorio, 2022).

Safety Procedure

Safety procedures are the process of preparing and enforcing rules that become guidelines that must be followed to improve safety throughout the work (Subramaniam, Mohd Zin, and Nadir (2013). *Infrastructure Health and Safety Association (IHSA, 2022)*, defines safety procedures as specific steps that guide workers through a task from start to finish, designed to reduce risk by minimizing potential hazards in the workplace. This procedure is formed according to guidelines and risk assessment in addition to the appropriate forms of prevention to reduce accidents.

Risk Management

Risk management is an initiative to help improve safe work culture practices on construction sites. Risk management has been evaluated through the aspects of risk identification and safety review. This is a process of controlling the risk of accidents (Ramirez, 2014). Therefore, construction contractors need to be responsible for implementing risk management to ensure effective accident prevention measures (Kouabenan, Nguetsa, & Mbaye, 2015). This is to ensure assurance and comfort to all contractors to provide safe work site equipment and structures.

METHODOLOGY

This study is a quantitative study using statistical analysis related to the level of practice of construction contractors in the states of Kelantan, Terengganu, and Pahang regarding aspects of safety and health in the workplace. The questionnaire used as a data collection instrument was distributed to project managers at construction contractors consisting of 376 people. The total sample according to Krejcie and Morgan (1970) based on a total population of 16185. Next, the preparation of a questionnaire based on an interval scale with a measurement scale of one to ten for respondents to express their level of agreement with each question presented. The results of the analysis use the Statistical Package for Social Sciences (SPSS) 24.0 software to analyse each level of occupational safety practices.

The level of safety and health practices at construction sites is assessed based on their assessment of the implementation of safety compliance, management commitment, safety training, safety communication, safety procedures, and risk management. The data obtained from the questionnaire were analysed using the Statistical Package for the Social Sciences (SPSS) software. The results of the study are explained based on descriptive data analysis methods, namely mean score and standard deviation. Therefore, the mean score level of the study results was evaluated based on Koh (2014) to determine the level of construct practice in the study sample. The details of the mean score level can be found in Table 1.

Table 1: Mean Score Level

Score Mean	Level
1.00 to 4.00	Low
4.01 to 7.00	Moderate
7.01 to 10.00	High

Source: Adapted from Koh (2014)

RESULT AND DISCUSSION

This analysis was conducted through mean scores and standard deviations to identify levels of management attitudes, safety compliance, and safety culture. The mean score and standard deviation were assessed through seven constructs, namely safety compliance, management commitment, safety training, safety communication, safety procedures, and risk management in the construction industry.

Table 2 shows the mean score and standard deviation for the analysis of management commitment among construction contractors. A high mean score value shown for management commitment is 7.2724 and the standard deviation: 1.72451. The findings of the study show that management commitment among respondents is high. High management commitment is the core to the formation of safety culture practices both theoretically and empirically (Zohar, 2008). This shows that the practice of a safety culture can be achieved through the commitment of management who always strive and are committed to implementing safety management in the construction sector.

Table 2 shows the mean score and standard deviation for safety training among construction contractors in east coast states. The average mean score value shown by safety training is 6.8807 and the standard deviation is 1.58372. Kim and Nguyen (2018) stated that safety training is at a moderate level because the number of contractors offering safety training to workers is decreasing. This lack of supply is the cause of respondents' lack of awareness about the importance of safety training.

The mean score and standard deviation of safety communication among construction contractors are moderate based on the values of 6.7131 and 1.79716. The findings of the study show that the level of safety communication is moderate due to the lack of two-way cooperation between contractors and workers in sharing safety information at the construction site. This is supported by Pandit et al., (2018) who discuss the level of safety communication in construction work is low because the contractor lacks support among employees to make the safety culture at the construction site a success.

Analysis of the mean score and standard deviation of safety procedures among construction contractors reached a moderate value of mean: 6.6804, and standard deviation: 1.75711. The results of the study show that the construction of safety procedures has a moderate level of practice among construction contractors. This is due to the commitment of organizations, especially small and medium-sized ones, which do not emphasize safety practices in the workplace. This issue has affected safety performance due to the perception of organizations that take a careless attitude toward safety on construction sites (Zakaria & Mazulkepli, 2021).

Analysis of the mean score and standard deviation for risk management analysis among construction contractors is at a moderate level based on the value of 6.0553 and 1.41184. The results of the study show that a moderate level of risk management among respondents occurs because at least inspections, risk assessments and safety audits from the management to know for sure the safety problems in the construction sector. The lack of this aspect has influenced the steps that need to be taken to control the risk of accidents (El Safty, ElSafty, & Malek, 2012).

The mean score and standard deviation for the analysis of the level of security compliance are high which are 7.5635 and 1.00179. This finding shows that high safety compliance can reduce the risk of accidents at work (Petitta et al., 2017). As a result, it can help improve safety performance in the construction sector and prevent accidents from continuing.

Based on the findings of the study, the overall level of practice for the construction of management commitment and safety compliance is at a high level. While the practice level of safety training, safety communication, safety procedures, and risk management is at a moderate level. The entire study findings are shown in Table 2.

Table 2: Analysis of Results for the Practice Level of Safety Management Attitudes

Construct	Score Mean	Standard Deviation	Level
Safety Compliance	7.5635	1.00179	High
Management Commitment	7.2724	1.72451	High
Safety Training	6.8807	1.58372	Moderate
Safety Communication	6.7131	1.79716	Moderate
Safety Procedure	6.6804	1.75711	Moderate
Risk Management	6.0553	1.41184	Moderate

CONCLUSION

The results of the study found that the level of safety management attitude of construction contractors is at a good level. This result shows that construction contractors in the states of Kelantan, Terengganu, and Pahang practice a high level of safety compliance. The results of the study found that management commitment, safety training, safety communication, safety procedures, and risk management have a moderate level of practice. Overall, this study has successfully demonstrated the importance of effective safety management attitudes in influencing construction contractors to demonstrate safe behaviour and attitudes at work and further comply with occupational safety regulations.

Overall, it can be concluded that effective safety management attitude can have an impact on occupational safety and health compliance. In addition, this study has also successfully demonstrated the importance of safety management attitude such as emphasis on safety training, management's commitment and communication, enforcement of safety procedures as well as risk assessment will influence management's behaviour to comply with occupational health and safety. Effective safety management attitude will create a safe work environment and culture. All evaluations of safety management attitude measures in this study have been successfully demonstrated, and they have contributed to our knowledge of safety management attitudes that can evolve along with the growth of a country's economy.

REFERENCES

- Arifin, K., Isa, W. M. Z. W., Zaini, Z. A. H., & Sahimi, A. S. (2021). Persepsi Terhadap Pelaksanaan Pengurusan Keselamatan Dan Kesihatan Pekerjaan Oleh Kakitangan Awam Di Putrajaya, Malaysia. *e-BANGI*, 18(2), 198-212.
- Basahel, A. M. (2021). Safety leadership, safety attitudes, safety knowledge and motivation toward safety-related behaviors in electrical substation construction projects. *International journal of environmental research and public health*, 18(8), 4196.

- Basahel, A. M. (2021). Safety leadership, safety attitudes, safety knowledge and motivation toward safety-related behaviors in electrical substation construction projects. *International journal of environmental research and public health*, 18(8), 4196.
- El Safty, A., ElSafty, A., & Malek, M. (2012). Construction Safety and Occupational Health Education in Egypt, the EU, and US Firms. *Open Journal of Civil Engineering*, 2, 174–182. <https://doi.org/10.4236/ojce.2012.23023>
- Haas, E. J., & Yorlano, P. L. (2022). Behavioral safety compliance in an interdependent mining environment: supervisor communication, procedural justice and the mediating role of coworker communication. *International journal of occupational safety and ergonomics*, 28(3), 1439-1451.
- Infrastructure Health and Safety Association (2022). Work Safe For Life. Retrieved from <https://www.ihsa.ca>
- Kim, S. Y., & Nguyen, V. (2018). Structural Equation Model of Interrelationships Among Constructs Affecting the Contractors' Poor Safety Performance. *Iranian Journal of Science and Technology, Transactions of Civil Engineering*, 43. <https://doi.org/10.1007/s40996-018-0145-9>
- Koh, L. C. (2014). *Ciri-Ciri Organisasi Pembelajaran Mengikuti Persepsi Guru Di Sekolah-Sekolah Menengah Di Malaysia*. Universiti Malaya.
- Kouabenan, Dongo Remi, Ngueutsa, R., & Mbaye, S. (2015). Safety climate, perceived risk, and involvement in safety management. *Safety Science*. <https://doi.org/10.1016/j.ssci.2015.03.009>
- Loosemore, M., & Malouf, N. (2019). Safety training and positive safety attitude formation in the Australian construction industry. *Safety science*, 113, 233-243.
- Martinez, J. G., Gheisari, M., & Alarcón, L. F. (2020). UAV integration in current construction safety planning and monitoring processes: Case study of a high-rise building construction project in Chile. *Journal of Management in Engineering*, 36(3), 05020005.
- Mashi, M. S., Subramaniam, C., & Johari, J. (2020). The effect of management commitment to safety, and safety communication and feedback on safety behavior of nurses: the moderating role of consideration of future safety consequences. *The International Journal of Human Resource Management*, 31(20), 2565-2594.
- McGonagle, A. K., Essenmacher, L., Hamblin, L., Luborsky, M., Upfal, M., & Arnetz, J. (2016). Management commitment to safety, teamwork, and hospital worker injuries. *Journal of hospital administration*, 5(6), 46.
- Newnam, S., & Goode, N. (2019). Communication in the workplace: Defining the conversations of supervisors. *Journal of safety research*, 70, 19-23.
- Oswald, D., Sherratt, F., Smith, S. D., & Hallowell, M. R. (2018). Exploring safety management challenges for multi-national construction workforces: a UK case study. *Construction management and economics*, 36(5), 291-301.
- Pandit, B., Albert, A., Patil, Y., & Al-Bayati, A. (2018). Fostering Safety Communication among Construction Workers: Role of Safety Climate and Crew-Level Cohesion. *International Journal of Environmental Research and Public Health*, 16, 71. <https://doi.org/10.3390/ijerph16010071>
- Petitta, L., Probst, T. M., Barbaranelli, C., & Ghezzi, V. (2017). Disentangling the roles of safety climate and safety culture: Multi-level effects on the relationship between supervisor enforcement and safety compliance. *Accident Analysis & Prevention*, 99, 77-89.
- Ramirez, L. S. M. (2014). *Safety Climate, Safety Hazards And Organizational Practices In The Construction Industry In Colombia*. University Of Massachusetts Lowell.

- Shafique, M., & Rafiq, M. (2019). An overview of construction occupational accidents in Hong Kong: A recent trend and future perspectives. *Applied Sciences*, 9(10), 2069.
- Subramaniam, C., Mohd Zin, M. L., & Nadir, S. (2013). Hubungan Amalan Pengurusan Keselamatan dengan Pematuhan Keselamatan Pekerjaan di Jabatan Bomba dan Penyelamat Malaysia (Relationship between Safety Management Practices and Job Safety Compliance in Fire and Rescue Department Malaysia). *Jurnal Pengurusan*, 37.
- Subramaniam, C., Shamsudin, F. M., Zin, M. L., Ramalu, S. S., & Hassan, Z. (2016). Safety management practices and safety compliance: A model for SMEs in Malaysia. *The European Proceedings of Social and Behavioural Sciences*, 856-862.
- Yiu, N. S., Sze, N. N., & Chan, D. W. (2018). Implementation of safety management systems in Hong Kong construction industry—A safety practitioner's perspective. *Journal of safety research*, 64, 1-9.
- Zailani, B. M., Abubakar, M., & Ibrahim, Y. M. (2021). The role of safety attitude in changing safety behaviour and hazard recognition capability of construction workers. In *Procs West Africa Built Environment Research (WABER) Conference* (pp. 9-11).
- Zakaria, N. S., & Mazulkepli, M. F. Bin. (2021). Critical Factors Affecting Accident Rates In The Construction Sector: A Literature Review. *Jurnal Komunikasi Borneo (JKOB)*, 9, 94–103.
- Zohar, D. (2008). Safety climate and beyond: A multi-level multi-climate framework. *Safety Science*, 46, 376–387. <https://doi.org/10.1016/j.ssci.2007.03.006>

Overview of Employee Voice on Expeditionary Employees

Didik Widianoro
Universitas Islam Riau
didikwidianoro@psy.ac.id

Yanwar Arief
Universitas Islam Riau
yanwar.arief@psy.uir.ac.id

Irfani Rizal
Universitas Islam Riau
irfanirizal27@psy.uir.ac.id

Nur Fitriyana
Universitas Muhammadiyah Riau
nurfitriyana@umri.ac.id

ABSTRACT

Voting as a form of constructive expression in enhancing organizational functioning and effectiveness has received great attention, especially in studies describing the antecedents and consequences of employee voice. One of the steps in preparing for this must pay attention to the quality of improving Human Resources. This is one of the supporters in the success of an organization. One of the capabilities of human resources that must be mastered properly is how to make the workplace one's own, and have a sense of participation in all activities to achieve goals. As well as the role of leaders in providing direction to human resources is also an important thing to implement. The purpose of this research is to see an overview of employee voice on expedition employees. This study uses a qualitative method with a phenomenological approach. Sampling technique with purposive sampling data collection technique. Collecting data using interview and observation techniques. The results of this study, in general, the employees in this study were able to convey voice aspirations or wishes to superiors and the company. Both the Promotive and Prohibitive voice dimensions.

Keywords: *Employee Voice, Employees*

INTRODUCTION

The background of this research proposal is regarding employee voice which is an important part of organizational development. This has become a serious concern for many companies. Employee voice refers to informal, free, and upward communication by employees about ideas, solutions, or concerns about work-related issues (LePine & Van Dyne, 1998; Morrison, 2014). It is a type of proactive work behavior that aims to improve the status quo (Parker & Collins, 2010). Employee voice behavior has been positively associated with desired outcomes such as individual and work unit job performance or organizational effectiveness (Frazier & Bowler, 2015; Kim, MacDuffie, & Pil, 2010; Lam & Mayer, 2014; Ng & Feldman, 2012; Whiting, Podsakoff, & Pierce, 2008). Due to the potential benefits of voice, scholars have turned their attention to promoting voice behavior in organizations (see Morrison, 2011, 2014 for reviews). Since leaders are usually the target of voices and their attitudes and behavior directly shape the willingness of employees to speak up (Morrison, 2014), leadership has been identified as an important factor that greatly determines the voice behavior of employees. In particular, transformational leadership which involves developing, supporting, and intellectually

stimulating employees to strive for a shared vision of the future (Kark & Shamir, 2002) has been theorized and reported as an important antecedent of employee voice behavior (e.g., Detert & Burris, 2007).

The impact of this problem is that an organization, especially a government with staffing regulations that have been regulated by law, cannot be separated from the role of employee voice in creating a better organization. Interactions within the organization are not only carried out internally but also externally, organizations also need employee ideas and opinions regarding matters of concern at work (Yang & Hwang, 2014). The mechanism for good employee voice is inseparable from the quality of human resources, because employee voice focuses on expressing opinions, suggestions, and feelings of concern about problems in the work environment (Tian et al., 2018). Employee voice indirectly increases employee control, increases satisfaction as well as work motivation which has an impact on minimizing work stress (Tian et al., 2018).

METHOD

The method in this study uses qualitative research with a phenomenological approach, because researchers are interested in exploring and understanding the description of employee voice that has been mentioned previously.

In this research, the subject that will be used by the researcher is a group of employees who are taken randomly. The research subjects consisted of 3 expedition employees. Collecting data in this study will use in-depth focused interviews (in-depth focused interviews). These interviews are an important resource in research using case studies. Focused in-depth interviews were conducted with open-ended questions, but the researcher used a set of pre-prepared question guides.

Data analysis in qualitative research is an effort made in organizing data, sorting data into units that can be processed, finding and determining data patterns, and discovering what is important and what can be learned from the data in order to determine what should be told. general public. Data analysis is the process of breaking down, separating or describing research material into pieces, parts, elements or units. After the data is broken down, the researcher sorts and filters the data to obtain the type, sequence class, pattern or overall picture.

RESULT

From the results of data collection through interviews of 3 research subjects, it was found that the description of the employee voice of expedition employees in general is able to voice aspirations to the company, this can be seen from;

"I always convey complaints as an employee, without any coercion from any party, as long as it is good for me and the company" (WIS117August2022)

The Promotive Voice aspect is also often given by subject 2;

"At work, I usually give advice during morning meetings, for example during the rainy season, I ask management to pay more attention to those of us who deliver on motorbikes, such as giving us coats so the packages we deliver don't get wet" (WIS218August2022).

This is also supported by subject 1 with an explanation that always provides input or ideas to the company so that each job can be optimized.

In addition, from the results of the discussion, it was also obtained that several employees had high concerns about the risk of road accidents. By carrying many packages, the safety factor is a top priority for expedition workers. Voice aspirations are not only given by work as the main reference, subject 3 explains the incentive factor to be a trigger for increasing motivation at work;

*"I always convey ideas for salary increases or bonuses, because from the start of work ... yes, almost 7 years, the increase was there but not significant sir."
(WIS320August2022)*

Maynes and Podsakoff (2014) state, to be called a voice, problems or opinions must: (a) be communicated openly, (b) organizationally related, (c) focused on influencing the work environment, and (d) accepted by someone in the organization. Voice can be expressed in the form of promotive behavior, namely the expression of employees about ideas or suggestions to improve organizational functions and prohibitive, namely the expression of employee concerns about work practices that are harmful to the organization (Liang, Farh & Farh, 2012).

CONCLUSION

The results of this study, in general, the employees in this study were able to convey voice aspirations or wishes to superiors and the company. Both the Promotive and Prohibitive voice dimensions. Employee voice is a form of communication within the organization.

REFERENCES

- Afsar, B., Shahjehan, A., Shah, S. I., & Wajid, A. (2019). The mediating role of transformational leadership in the relationship between cultural intelligence and employee voice behavior: A case of hotel employees. *International Journal of Intercultural Relations*, 69(October 2018), 66–75. <https://doi.org/10.1016/j.ijintrel.2019.01.001>
- Cumming, T.G & Worley, C.G. (2005). *Organization Development and Change : Eight Edition*. New York : Thomson South Westren
- Detert, J. R., & Burris, E. R. (2007). Leadership behavior and employee voice: Is the door really open? *Academy of Management Journal*, 50, 869–884.
- Duan, J., Li, C., Xu, Y., & Wu, C. H. (2017). Transformational leadership and employee voice behavior: A Pygmalion mechanism. *Journal of Organizational Behavior*, 38(5), 650–670.
- Frazier, M. L., & Bowler, W. M. (2015). Voice climate, supervisor undermining, and work outcomes: A group-level examination. *Journal of Management*, 41, 841–863.
- Kark, R., & Shamir, B. (2002). The influence of transformational leadership on followers' relational versus collective self-concept. *Academy of Management Annual Meeting Proceedings*, 2002(1), D1–D6.
- Kim, J., MacDuffie, J. P., & Pil, F. K. (2010). Employee voice and organizational performance: Team versus representative influence. *Human Relations*, 63, 371–394.
- Lam, C. F., & Mayer, D. M. (2014). When do employees speak up for their customers? A model of voice in a customer service context. *Personnel Psychology*, 67, 637–666.
- LePine, J. A., & Van Dyne, L. (1998). Predicting voice behavior in work groups. *Journal of Applied Psychology*, 83, 853–868

- Morrison, E. W. (2014). Employee voice and silence. *Annual Review of Organizational Psychology and Organizational Behavior*, 1, 173–197.
- Parker, S. K., & Collins, C. G. (2010). Taking stock: Integrating and differentiating multiple proactive behaviors. *Journal of Management*, 36, 633–662.
- Robbins, S. P. (2008). *Perilaku Organisasi*. New Jersey : Prentice Hal I



UNIVERSITI

MALAYSIA

KELANTAN

Gig Economy and Workers in Logistic Industry on Malaysia's Perspective

Izatul Husna Zakaria

*School of Technology Management & Logistics, Universiti Utara Malaysia,
Malaysia, 06010, Kedah, Malaysia*
izatul.husna.zakaria@uum.edu.my

Siti Fatimah Mohd Nasaruddin

*School of Technology Management & Logistics, Universiti Utara Malaysia,
Malaysia, 06010, Kedah, Malaysia*

Mohd Zulfabli bin Hasan

*School of Technology Management & Logistics, Universiti Utara Malaysia,
Malaysia, 06010, Kedah, Malaysia*

Mawaddah binti Mohamad

*School of Technology Management & Logistics, Universiti Utara Malaysia,
Malaysia, 06010, Kedah, Malaysia*

Nur'Jila Mohammad

*School of Technology Management & Logistics, Universiti Utara Malaysia,
Malaysia, 06010, Kedah, Malaysia*

Siti Hawa binti Harith

*School of Technology Management & Logistics, Universiti Utara Malaysia,
Malaysia, 06010, Kedah, Malaysia*

ABSTRACT

The gig economy has low barriers to entry, enabling flexible work arrangements and allowing workers to engage in contingent employment, whenever, and in some cases, such as online labor markets, wherever workers desire. The growth of the gig economy has been partly attributed to technological advancements that enable flexible work environments. This paper highlight on the definition and trends of gig economy, factors that influenced people working as gig worker and how does it effect on logistic industry in Malaysia.

Keywords: *Gig workers, critical success, logistic industry*

INTRODUCTION

Workers are expressing an increasing demand on autonomous and flexible work time. This is particularly evident amongst youth, signaling a generational shift towards greater freedom and entrepreneurship. With the advance of digital freelance marketplaces, high speed internet and high- powered mobile computing tools, this will encourage more freelancer to be attainable than ever. These trends make the gig economy more relevant and prominent in today's digital era.

The people's participation to become gig workers is an interesting phenomenon. Gig workers intend to face the risk compared to the conventional workers due to some handicaps such as uncertain project frequency, uncertain income and working hours (Gandhi et.al, 2018).

In this article, we present a review paper on the history the raising of gig economy, trends and factors influencing gig works in Malaysia's perspective.

DEFINITIONS AND TERMINOLOGY

The technological advancements throughout the years have brought fundamental changes to the way of working and type of location where we do the work. The game changer of this type of employment are due to the rise of platform economy, the current situation, low barriers of entry and flexibility of working hours and place (Chen et.al 2017; Mas and Pallais, 2017)

There is no accepted definition of the gig economy. It is often termed as ‘platform economy’, ‘on demand economy’, and ‘sharing economy’ that refers to the demand and supply of short term or task based working activities that are matched through online labour platform via mobile work on demand via apps (De Stefano, 2016). Gig economy is a free-market system where organizations contract with independent workers for a short-term project or service engagement (TechTarget, 2020). Donovan, Bradley & Shimabukuru (2016) stated that the gig economy is the collection of markets that match providers to consumers on a gig (or job) in support of on-demand commerce. According to Abraham et al. (2018), the term gig economy refers to work obtained through an online platform with work doled out in bits and pieces. He too defined gig workers as a worker that has no wage or salary, unclear contracts of agreement for continuing relationship, has no fixed schedule and unpredictable income. This includes independent contractors, freelancers, day labourers and on-demand workers. In Ireland and United Kingdom, gig economy generally refers to app-based services done on demand and on location. International Labour Organisation (ILO) (2018) noted that forms of work in the gig economy include “crowdwork” which referred to working activities that imply completing a series of tasks through online platforms, and “work-on- demand via apps” channeled through apps managed by firms.

In Malaysia, the gig economy is treated as a separate silo of the economy with its workers facing many social and economic adversaries and often being exploited by platform providers (Sun Cheng Kidd, 2020). ILO studies used the status in employment “independent contractor” from household surveys as a proxy to identify gig workers (DOSM,2020). It also had been defined as a free-market system where the transactions are task based and the workers work independently without being bound to long term contract with any company (Nisya Aziz, 2020). Ideally, gig workers ought to be defined as employed persons who worked on flexible hours, flexible workplace, with or without digital presence with status as independent workers, freelancers or part-time employees (Harun, Nurfarahin Ali et.al., 2020).

Within the global landscape, there exists a gap in which this phenomenon cannot be conceptually defined and statistically measured uniformly, and hence, comparable measure across countries remains a challenge.

THE GIG ECONOMY AND ITS TREND IN MALAYSIA

The word ‘gig’ has usually been common with musicians especially the jazz musicians who are called to entertain for a short period, such as during events. Since 1940s, a few of temporary agencies rise up such as Russ Kelly Office Services and Manpower Inc to offer part time jobs and supply temporary staff to other organizations (Brian, 2019). The gig economy has become more popular in the last five years as the mass adoption of the internet and increasing penetration of smartphones, connecting online users across the countries over the digital platforms (Roy G. & Shrivastava A.K., 2020) Digital platforms create efficient marketplaces to facilitate direct connections between customers and service providers. The abundance of online job platforms has made it easier for people to freelance and carve out their income in

the gig economy. Thanks to digitization, anyone can be part of the gig economy and it's gaining a lot of attention. Plus, it has disrupted the conventional businesses on a global scale and opened up new avenues to generate income. This new world of economy has been spread to the other part of the world and give opportunities people to explore more on the jobs that give them more flexibility and satisfying either on time, workplace or income.

In Malaysia, according to the World Bank data, about 26% of the Malaysian workforce are freelancers and that the number is growing, as more people are opting for more flexible working hours (Star, 2019). On the surface, the gig economy seems to be dominated by e-hailing and start-ups. There are currently more than 160,000 e-hailing drivers in Malaysia. Due to the pandemic outbreak of Covid-19, the gig economy giving more opportunities for Malaysia youths, housewife and the unfortunate who lost their woks to be employ as a gig worker.

The rise of the gig economy over the past decade can be attributed to the confluence of two major trends. First, the participation of young jobseekers who tried to gain experience before entering the real work world and secondly, the increasing spread of digital connectivity (Sun Chung Kidd, 2020). It is reported almost 26.4million young Malaysians has entered the labour market between February 2012 and February 2020 (Labour Force Statistic, 2013, 2020)

The World Bank estimates that the global gig economy is growing by about 33% annually in 2015, while Malaysia's Employees Provident Fund (EPF) reported that the gig economy workforce in Malaysia had grown by 31% in 2017, surpassing the growth in the conventional workforce. By 2019, 26% of the total 15.3 million Malaysian workforce form part of the growing gig economy as reported by the World Bank. These statistics, however, are doubtful due to the vagueness in the classification and definition of the gig economy. On the bright side, Malaysia has some definite figures on gig workers and crowd workers. In terms of transportation and delivery services (gig work), there are currently about 90,000 drivers (with Public Service Vehicle (PSV) license) or about 200,000 drivers (with and without PSV license) across 46 e-hailing companies. While the market size of the Malaysian crowd economy is estimated to be valued at RM949 million in 2018. Moreover, there are nearly 158,000 trained digital workers under Malaysia's Digital Economy Corporation (MDEC)'s flagship platforms, eRezeki and the Global Online Workforce (GLOW) in the same year. These statistics have clearly supported the argument that the gig economy is on a meteoric rise by its contribution to the economy. Hence, the gig economy should not be conceived as a separate silo in the Malaysian economy.

There is a forecast that said, by 2021, gig workers' (freelancer, independent and contract workers) will outnumber traditional employee.

CRITICAL SUCCESS OF GIG WORKERS

Many workers (particularly those of Generation Y) are disenchanted with their 9 to 5 routine and have an increasing need for flexible and diversified work. Others, unable to secure employment in the challenging labour market, have turned to freelancing out of necessity. Youth in many countries built start up as a modern entrepreneurial works and caused of the growth of gig workers.

Competence and interest are believed as trigger which motivates personally to become gig worker. Gandhi et. al (2018) study shows that the factors influencing the rise of gig workers

are need for success or achievement, need for independent, and economic motivation. Flexibility time and limitless location become interest features although uncertainty job and salary appear as threat. Social influence also contributes to inspire more people to join as a gig worker (Gandhi, A. et.al, 2018).

Need for success or achievement refers to an individual's desire for accomplishment, to perform and complete challenging tasks, and mastering of skills (McClelland, 1961). Need for achievement was developed and popularized by McClelland (1961) as a part of his Need Theory, and he argues that the individuals that have qualities associated with high need for achievement are more likely to be involved in entrepreneurial activities. These activities and entrepreneurial tasks require individual skill and effort, are moderately risky and have a high degree of individual responsibility for outcomes (Kristin K. & Johan W., 2019)

Desire for independence has been frequently associated with entrepreneurial values and behavior, and involves the person taking responsibility and using their own judgement instead of blindly following others (Shane et al., 2003). Independence is likely to find expression in an individual's will to manage one's own time and the individual's will to be one's own boss (Ranyard, 2017). Independence is a necessitative trait for entrepreneurs, as the entrepreneur takes responsibility for exploiting an opportunity as well as responsibility for the end results of the venture (Shane et al., 2003). Thereto, an individual may be pulled towards entrepreneurship because of a desire for independence.

Economic motivation should be important factor since it is basic reason for people search and do work professionally. Received payment in a short duration and fast enough influences their intention. This relationship is associated with the platform's credibility as e-marketplace. By fast payment, gig worker can perceive safety and credibility (Gandhi, A. et.al, 2018)

GIG WORKERS IN LOGISTIC INDUSTRY

Multiple data sources confirm that gig activity in the passenger transportation industry has grown phenomenally since 2013. Hall and Krueger (2018) show that the number of active Uber drivers was essentially zero in the middle of 2012 and grew exponentially over the next three years to 465,000 by the end of 2015. In the latest of a series of papers from the JP Morgan Chase Institute, Farrell, Grieg, and Hamoudi (2018) also documents rapid growth in transportation-sector gig activity.

The changes in passenger transportation have been associated with significant shifts in worker demographics (e.g., drivers who are more likely to be young and female) and workers appear to be taking advantage of the opportunity to drive on a flexible basis to supplement income from other sources. The rapid and dramatic changes in the passenger transportation sector nonetheless highlight the potential for change. Adoption of new technologies often involves long and variable lags.

In Malaysia, ever since the outbreak of pandemic Covid-19 shows the unemployment rate jumped to 3.9% in March. The minimal contact and social distancing behaviors to avoid Covid-19 cross transmission has forced people to adjust their preferences to search for services that could provide digital solutions and options. Therefore, the future is tremendous for online business, as well as its support services including logistics transport, and warehousing in transfer of goods (Nurhanani Azman, 2020). This can be seen on the growth of Foodpanda riders, Grab drivers and

many courier services looking ways to meet internal targets and deadlines that employ gig workers to work. Gig worker do not necessarily become the producer of goods, but the bridge that provide service and products especially becoming a strategic logistics and transportation hub.

CONCLUSION

The Malaysian gig economy is set to bring in US\$2.7 trillion by 2025. This is because the industry is rapidly growing with the fastest-growing jobs online involving writing, programming, and blockchain technology. Generally, the gig economy has helped improved Malaysia's GDP as it has in a way or another helped some individuals to secure additional income or act as an employment opportunity to some who could have been entirely jobless.

REFERENCES

- A. Gandhi, A.N Hidayanto, Y.G Suchahyo, Y. Ruldeviyani "Exploring People's Intention to Become Platform-based Gig Workers: An Empirical Qualitative Study," *2018 International Conference on Information Technology Systems and Innovation (ICITSI)*, Bandung-Padang, Indonesia, 2018, pp. 266-271.
- Star (2019), *Working in the gig economy*. <https://www.thestar.com.my/business/business-news/2019/04/06/working-in-the-gig-economy>
- Brian Wallace (2019). The History and Future of the Gig Economy. Retrieved from <https://www.linkedin.com/pulse/history-future-gig-economy-brian-wallace>
- Nisha Aziz (2020). Gig Economy Malaysia: Empowerment or Exploitation? Retrieved from <https://loanstreet.com.my/learning-centre/gig-economy-malaysia-empowerment-or-exploitation>
- Donovan SA, Bradley DH, Shimabukuro JO (2016) What Does the Gig Economy Mean for Workers? CRS Report. Congressional Research Service
- Abraham KG, Sandusky L, Haltiwanger JC, Spletzer JR. (2018) [cited 2021 March]. Available from: <https://www.aeaweb.org/conference/2019/preliminary/paper/4r9TeS37>.
- Stefano VD (2016). The rise of the "just-in-time workforce": On-demand work, crowdwork and labour protection in the "gig-economy". 1st ed.: International Labour Organisation
- Harun, Nurfarahin, Ali, Noraliza Mohamad, and Khan, Nur Layali Mohd Ali. 'An Experimental Measure of Malaysia's Gig Workers Using Labour Force Survey'. 1 Jan. 2020 : 969 – 977.
- Department of Statistic Malaysia, DOSM (2020)
- Sun Cheng Kidd, 2020. Conceptualizing the Gig Economy in Malaysia. Research for Social Advancement (REFSA Brief). Issue 7. June 2020
- TechTarget, 2020. Gig Economy. Retrieved from <https://whatis.techtarget.com/definition/gigeconomy>.
- Department of Statistic Malaysia, DOSM (2013). Labour Force Statistic, August 2013.
- Department of Statistic Malaysia, DOSM (2020). Labour Force Statistic, August 2020.
- Hall, J.V., and Krueger, A.B (2018). An analysis of the labor market for Uber's driver-partners in the United States. *ILR Review*, 71, 705–732.
- Farrell, Grieg, and Hamoudi (2018).
- Nurhanani Azman, 2020. Gig economy to emerge as essential employment sector. <https://themalaysianreserve.com/2020/05/18/gig-economy-to-emerge-as-essential-employment-sector/>.
- Kritin Karlsson & Johan Wranne (2019). Motivation in the gig economy: A case study of gig workers in the IT and Business Consulting Industry. Master of Science Thesis. KTH Royal Institute of Technology.

Aspirations for Doctoral Study Among Academic Staff

Nazatul Syima Mohd Nasir
Universiti Malaysia Kelantan
syima@umk.edu.my

Khairul Hisyam Baharuddin
Universiti Malaysia Kelantan
khairulhisyam@umk.edu.my

Fairuz A'dilah Rusdi
Universiti Malaysia Kelantan
fairuz@umk.edu.my

ABSTRACT

Engaging in doctoral studies comes with a variety of motives held by the students whose perspectives also vary about studying at that level. Nevertheless, the Malaysian public university lecturers' motives for undertaking doctoral studies remain unclear. This study undertook to explore the factors that prompt them to enroll as PhD students. Procedurally, the researcher recruited six public university lecturers as participants. Using semi-structured interviews, the researcher sought to establish the participants' motivations for entry in doctoral programmes. Accordingly, the major influential factors that emerged had to do with the acquisition of higher status, encouragement from peers, contractual conditions and deep-seated desire for self-fulfillment. Subsequent to the findings the researcher devised a set of recommendations targeting potential doctoral candidates and institutions, as a means to fine-tune their motivations for the qualification.

Keywords: *Aspiration; Doctoral Study; Academic Staff; Doctoral Candidate*

INTRODUCTION

As the most superior academic qualification, a Doctor of Philosophy (PhD), is issued to candidates who fulfill the requirements of study at the highest level. A fundamental requirement for PhD candidates is to mastermind novel ideas presented in the form of thoroughly researched theses. To ensure the prevalence of rigor at this level of study, candidates undertake to defend their propositions in the presence of field specialists. Admittedly, the acquisition of a PhD is advantageous in numerous ways, including empowering individuals to progressively discover the dynamic facets of a vast academic field of their interest (San-Jose & Retolaza, 2021; Cowan, Hartjes, & Munro, 2019). Owing to the high status of a PhD, holders thereof are regarded as experts in their respective areas of specialisation, who are strategically placed to spearhead development in society. At the personal level, a PhD qualification offers competitive advantage in occupational considerations. It gives leverage in view of advancing one's research interests as backed up by their passion. Furthermore, earning a PhD is a process that involves networking for future collaborations. In turn, networks are fundamental for breaking barriers as they facilitate exposure to multiple occupational prospects, both nationally and internationally (Stanfill et al., 2019).

Although the acquisition of a PhD is heavily linked to numerous gains, there are hardly any established reasons for individuals to attain this qualification. Given the risks involved in engaging in PhD studies, it is not surprising that many people are skeptical of it. For instance,

experiencing stress due to workload is almost inevitable (Abu-Zaid et al., 2016), which presents a challenge in terms of mental health. Besides dealing with the demands of the studies at this highest level of learning, students are almost always confronted by the problem of funding (Maher et al., 2014). Although most PhD students strategically rely on funding from abroad, there is no guarantee in securing sponsors or adequate sponsorship. In some instances, the flow of funding has been limited contrary to the students' expectations. As such, students are subjected to stressful situations where they must find the balance between studying and catering for their well-being. Moreover, students are obliged to deal with time constraints, considering the demands of their studies (Rimando et al., 2015). There is always a danger of failing to strike the balance between work and social life. Implicitly, those who pursue PhD studies have to overcome enormous challenges to succeed. Wiegrová (2016) noted that the pursuit of a PhD is mainly hampered on two fronts – the macrosocial and microsocial elements. Accordingly, PhD candidates are affected by macrosocial elements like the current labour market, social climate, and employment. Concurrently, they are subject to microsocial elements inclusive of the extent of belief in oneself and maturity. From a computer science perspective, Moreno and Kollanus (2013) researched to establish the motives of PhD candidates. Among their findings were the desire for professional advancement, enhancing employability, self-actualisation, and the necessity of career shifting as influential factors for engaging in doctoral studies.

OBJECTIVE OF THE STUDY

The current researcher aimed to establish the primary motivations of Malaysian public university lecturers in pursuing PhD programmes. Hence, the explicit objective in this paper is to cultivate comprehension and awareness of public university lecturers' decisions to take up doctorate programmes. Equipped with this knowledge, university administrators and policy makers will be in a better position to design programmes in a manner that meets the specific needs of these Malaysian public university lecturers.

LITERATURE REVIEW

For Yang, Chen, and Shen (2017) it is a priority for many students for their education to have an international outlook, especially at doctoral level. Specifically, they are motivated by the need to overcome elements of parochialism; with the attainment of this highest qualification, they feel empowered to add value to their fields of learning. Beyond that, students enroll for PhDs with the motive to improve their employability (Khojastehrad & Sattarova, 2015). Stated otherwise, a PhD qualification is considered a leveraging factor for candidates in the labour market. The necessity for competitiveness in the labour market is corroborated by Singh and Jack (2018), who opined that the qualification also improves their national status. From these preliminary remarks, it is important gather evidence about the motivation for doctoral studies in the Malaysian context.

Generally, there is a noted better accessibility to higher education in recent times worldwide as more institutions are offering greater flexibility for studies. For instance, the United States witnessed a 14% increase in PhD enrollment in 2017 (National Science Foundation, National Center for Science and Engineering Statistics, 2018). The increase in PhD enrollment and graduation was reflected in various fields (Sakurai, Vekkalia, & Pyhalto, 2017). Nevertheless, the field of education presented significant statistics in view of doctorates conferred countrywide, with 4,823 doctoral degrees issued in 2017 as rated against 6,448 doctoral degrees issued in 2007, translating into a 34% decline. Various studies identified the increased costs of higher education as the major cause of the decline in PhDs

output. Since most of those who desire to pursue doctoral studies in education are currently teaching and are underpaid, their capacity to fund their studies is supposedly limited.

There are multiple suggestions on the hindrances in pursuing doctorate studies. In Golde's (2005) view, opting for PhD studies is a high-risk undertaking, yet a considerable number of people are still enrolling for doctorates (Skakni, 2018). Some of the leading reasons for attaining PhDs relate to career improvement, personal advancement, and inherent interest in one's field. For some students, a PhD gives them a new sense of identity in the face of societal competition (Lynch, Salikhova, & Salikhova, 2018). Besides that, the role of third parties cannot be underestimated in the determination of taking up doctoral studies (Ceglie, 2019). Yet, there is still a huge knowledge gap in terms of what aspires lecturers in Malaysian institutions to undertake doctoral studies. Therefore, a study in this regard will be important for both policymakers and those who design curriculum.

METHOD

Using a qualitative research methodology, the study explored the primary motivation or aspiration for lecturers enrolling for doctoral programmes. Procedurally, the researcher enlisted six public university lecturers as participants. As tools for gathering data, in-depth semi-structured interviews were used to establish motivations for pursuing PhDs. Participants were free to respond to open-ended questions, thereby offering insights into their motivations in enrolling for doctoral studies. In the same vein, the participants were easily drawn to venture into sensitive issues related to the matter without feeling uncomfortable (Brown & Danaher, 2019; Mojtahed et al., 2019).

After the interviews, the researcher had the privilege to analyse the responses and to deductively attribute reasons for specific answers. Prior consent to participate in the study was sought from the participants; they did so on voluntary basis (Hardicre, 2014; Mandal & Parija, 2014). The selection criteria was such that participants ought to have earned doctoral degrees, no longer than a couple of years ago. Furthermore, participants needed to have significant career experiences, and to be within the age bracket of thirties. The analysis of the results was thematic. The researcher utilised the NVivo 11, a qualitative data analysis tool, to analyse the data. Accordingly, the focus group and interview data were categorised into NVivo nodes beneath the significant themes developed during the process of analysing data. While analysing data, the key that emerged in the participants' responses were, identified, categorised, summarised, and recombined. The data was subsequently analysed in terms of the underlying patterns or trends pointing to specific conclusions.

MAIN RESULTS

The researcher emerged with major themes in view of the aspirations for doctoral studies. These themes included personal support, contractual conditions, intrinsic motivation, and the necessity for identity and image improvement, all described in detail as follows.

Contractual Conditions

Accordingly, the parties in a contract have obligations to fulfill, as exemplified by two participants who mentioned that their financial assistance was guaranteed as long as they pursued a PhD. Participant 1 remarked that "After completing my masters' degree in History, the institution convinced me to pursue a doctoral degree at no cost. After some thinking, I

considered that it was a good offer since it would alleviate financial pressure on me.” Participant 2 said “The faculty promised that my education needs would be catered for if I pursued a doctoral degree in my field. This opportunity was too good to pass up.” Among the employment terms, one of the most important is that lecturers in education have the obligation to apply and secure PhD admission at institutions in Malaysia or overseas. In this light, Malaysian institutions normally offer scholarships with contractual duties, making it clear that their employees are under obligation to improve their skills, thereby assisting their institutions to progressively become globally competitive.

Personal Support

A significant percentage of the participants cited the importance of support received from family members and friends, who encouraged them to pursue doctoral studies. For example, Participant 6 confessedly remarked that “Initially, I did not believe that it would be possible to pursue my PhD. However, people around me, especially my family, convinced me that they would offer all the support I need in my studies.” Participant 4 said “I spoke to a close friend who is a lecturer. After long discussions concerning the opportunities that a doctoral degree would offer, I decided to give it a try.” PhD candidates usually receive support from peers, workmates, family members, and academic supervisors.

Intrinsic Motivation

Among various reasons for pursuing doctoral studies, is the quest for cultural or personal identity. For instance, participant 3 intimated that “Even after completing my masters, I still believed that my academic career was not over. Therefore, after two years, I decided to pursue a doctoral degree.” Participant 3 mentioned that ‘Pursuing a PhD has always been my dream since childhood.’ The personal need to engage in PhD studies has been corroborated in the literature as a key intrinsic motivator that influences participant decisions in favour of furthering their studies.

Identity and Image Improvement

The one motivating factor that emerged during the interviews for attaining a doctoral qualification was the enhancement of one’s status in society. For example, Participant 4 remarked that “Pursing a PhD makes it easy to attain recognition wherever I go.” Participant 5 declared that “Having a doctoral degree offers me a more significant status in the academic and social world, and people would call me a Doctor.” The participants generally observed that the prospect of earning the title "Dr." motivated them, and that this prompted them to further their education. Hence, education is not pursued not only for the sake of knowledge; it is also essentially sought for the improvement of one’s status and identity.

According to the findings, people are influenced by various factors to enroll for PhDs, including the anticipation of recognition and status in society, intrinsic motivations, support from family and friends, and favourable contractual circumstances. Nevertheless, participants expressed elements of doubt, bearing in mind the potential risks associated with undertaking doctoral studies. Although the participants were very few, the diversity of content they generated for the themes was rich enough to provide consistency pointing to the reliability of the findings.

CONCLUSION

A Doctor of Philosophy (PhD) is the highest level of academic learning. Earning it comes with advantages like indulging ones' interests, exposure to a wide variety of opportunities at the national and international level. Comparatively, the dearth of literature on specific motivating factors for pursuing doctoral studies does not do justice to the numerous challenges confronting PhD candidates. This study has identified factors like intrinsic and extrinsic motivation, contractual conditions, support from others, and identity and image improvement as the main motivating factors for engaging in doctoral studies among academic staff.

LIMITATION OF THE STUDY

The main limitation for this study was the small sample size, which comprised of six participants. As such, the findings may not be easily generalised, since doing so requires carrying out research using a relatively bigger sample to represent a population.

REFERENCES

- Brown, A., & Danaher, P. A. (2019). CHE principles: Facilitating authentic and dialogical semi- structured interviews in educational research. *International Journal of Research & Method in Education*, 42(1), 76-90.
- Ceglie, R. (2019). Initial Motivations of Doctoral Education Students. *Journal for the Advancement of Educational Research*, 21-33.
- Cowan, L., Hartjes, T., & Munro, S. (2019). A model of successful DNP and PhD collaboration. *Journal of the American Association of Nurse Practitioners*, 31(2), 116-123.
- Hardicre, J. (2014). Valid informed consent in research: An introduction. *British Journal of Nursing*, 23(11), 564-567.
- Lynch, M. F., Salikhova, N. R., & Salikhova, A. B. (2018). Internal motivation among doctoral students: Contributions from the student and from the student's environment. *International Journal of Doctoral Studies*, 255-272.
- Maher, M. A., Feldon, D. F., Timmerman, B. E., & Chao, J. (2014). Faculty perceptions of common challenges encountered by novice doctoral writers. *Higher Education Research & Development*, 33(4), 699-711.
- Mandal, J., & Parija, S. C. (2014). Informed consent and research. *Tropical Parasitology*, 4(2), 78-90.
- Mojtahed, R., Nunes, M. B., Martins, J. T., & Peng, A. (2014). Equipping the constructivist researcher: The combined use of semi-structured interviews and decision-making maps. *Electronic Journal of Business Research Methods*, 12(2).
- Moreno, M. D. C. C., & Kollanus, S. (2013, October). On the motivations to enroll in doctoral studies in Computer Science—A comparison of PhD program models. In *2013 12th International Conference on Information Technology Based Higher Education and Training (ITHET)* (pp. 1-8). IEEE.
- Singh, J. K. N., & Jack, G. (2018). The benefits of overseas study for international postgraduate students in Malaysia. *Higher Education*, 75(4), 607-624.
- Skakni, I. (2018). Reasons, motives and motivations for completing a PhD: a typology of doctoral studies as a quest. *Studies in Graduate and Postdoctoral Education*.
- Rimando, M., Brace, A. M., Namageyo-Funa, A., Parr, T. L., Sealy, D. A., Davis, T. L., & Christiana, R. W. (2015). Data collection challenges and recommendations for early career researchers. *The Qualitative Report*, 20(12), 2025-2036.

- San-Jose, L., & Retolaza, J. L. (2021). The value of the PhD degree in management science. *SN Business & Economics*, 1(3), 1-19.
- Stanfill, A. G., Aycock, D., Dionne-Odom, J. N., & Rosa, W. E. (2019). Strategies and resources for increasing the PhD pipeline and producing independent nurse scientists. *Journal of Nursing Scholarship*, 51(6), 717-726.
- Wiegerová, A. (2016). A study of the motives of doctoral students. *Procedia-Social and Behavioral Sciences*, 217, 123-131.
- Khojastehrad, S., & Sattarova, M. (2015). International students' linguistic awareness of Malaysian English and its impact on intercultural communication effectiveness. *Advances in Language and Literary Studies*, 6(5), 250-259.
- Yang, S., Chen, X., & Shen, X. (2017). An exploratory study of customer satisfaction with international student recruitment agencies: A case study in New Zealand. *International Journal of Business and Management*, 12(11), 130.



The Influence of Forgiveness Techniques on Family Conflict in Students

Puti Febrina Niko
Universitas Muhammadiyah Riau

Yohan Kurniawan
Universiti Malaysia Kelantan

ABSTRACT

Family conflict is something that often happens in the family. Family conflicts often occur such as differences of opinion, children feeling less attention, lack of communication, and so on. If the family conflict is not resolved, it will continue to become domestic violence which will have an impact on the physical and psychological development of the family members so that they feel uncomfortable being in the family. One way to reduce conflict in the family is to forgive. Forgiveness means releasing the affection, behavior, cognition, and motivation of hurt. Forgiveness aims to dispel years of negative emotions into positive emotions that can improve mental health. The purpose of this study was to determine the effect of forgiveness on family conflict. The research method used is quantitative using Trim-18 as the scale of forgiveness and family conflict scale. The number of samples in this study was 107 students of the Faculty of Islamic Studies, University of Muhammadiyah Riau. How to collect data using the scale of forgiveness and family conflict with data analysis using the Wilcoxon test. The results of the study obtained a P value <0.05. This study concludes that there is an influence between forgiveness and family conflict as much as 37.4%.

Keywords: *Forgiveness, family conflict*

INTRODUCTION

Violence in the family stems from conflict within the family. Conflict is a state of disharmony manifested by contradictions as a result of not achieving expectations and desires. Meanwhile, conflict in the family is a term used to describe an inharmonious family atmosphere and a harmonious and prosperous family condition that causes conflict and division in the family.

If conflicts in the family are not resolved, it will continue to become domestic violence which has an impact on the physical and psychological well-being of children. Kurniasari, 2019 said that the forms of behavior due to mistreatment from parents are being permissive, depressive, aggressive, and destructive. Positive children start with positive families. This is because according to Gunarsa (2009) states that the family is the first environment that initially gives a deep influence on children. From family members (fathers, mothers and children) acquire all basic abilities, both intellectual and social. This means that every attitude or view and opinion of parents or other family members will be used as an example by children in behaving. Because in the family, children first get knowledge about values and norms, in order to achieve all of this, a harmonious family must be formed.

The family as a system is where a teenager forms and develops personality and character. The importance of the family as a system can be seen from the many variations of household products that form the components of society. How many households today are experiencing dysfunction because each member as a component that drives the household system has problems with other members or with himself.

Worthington (2007) asserts that forgiveness means relieving the affection, behavior, cognition, and motivation of hurt. The basic mechanisms that are often used by individuals in dealing with heartache are; first, denial by covering up all negative thoughts, feelings, behaviors, and motivations you have; secondly, the expression of aggression by passively or actively resisting the cause of injury or illness; third, forgiveness, namely by managing.

Forgiveness aims to dispel years of negative emotions into positive emotions that can improve mental health. Research reports that forgiveness can improve psychological well-being (Maulida & Sari, 2016), improve mental health (Raj, Elizabeth & Padmakumari, 2016), increasing interpersonal trust in friendships (Utami, 2015), self-maturity (Sumiati & Sandjaja 2013), and increasing self-acceptance (Rahmandani & Subandi, 2010).

According to Worthington (2010) the key to forgiveness is confronting emotions related to unpleasant experiences, resolving unfinished situations and then releasing negative emotions towards those who hurt. Therefore, therapy that is considered theoretically suitable for increasing forgiveness is a therapy that invites individuals to reconstruct past experiences in order to attack emotions related to unpleasant experiences. So researchers use psychodrama as one of the facilities of forgiveness therapy.

RESEARCH METHODS

This study uses quantitative research methods with the dependent variable (Y) being family conflict, and the independent variable (X) being forgiveness. The subjects of this study were students of the Faculty of Islamic Studies with a population of 367 people with a sample of 107 people. The research was taken using a random sampling technique by randomly taking research subjects according to the environment in the focus of this study.

This study used two scales, namely the forgiveness scale and the family conflict scale. The family conflict scale uses the scale from Rahmayani Hasibuan (2016) with aspects namely silent culture, immaturity of parental attitudes, parents who lack a sense of responsibility, and the cold war in the family. While measuring the level of forgiveness used the Transgression-Related Interpersonal Motivations (TRIM) Inventory-18 Item Version or TRIM-18 scale which has three aspects, namely benevolence motivations, avoidance motivations, and revenge motivations.

Data analysis methods are normality test, linearity test, and hypothesis test. 1) The normality test is used to test whether in the regression model, the dependent variable and independent variable have a normal distribution or not. 2) Muliani's Linearity Test (2020) The Linearity Test was carried out aiming to find out the relationship between the independent and dependent variables whether it is linear or not. Linear means a relationship like a straight line. 3) The hypothesis test in this study is to use the Wilcoxon Test and the Determination Test (R-Square). Analysis of the research data used influence analysis to find the influence between the level of religiosity and prosocial behavior of Muhammadiyah Riau University students, using the SPSS statistical program.

RESULTS AND DISCUSSION

Results

Based on the results of the normality test, the significance value of forgiveness is 0.000 ($P < 0.05$) and the significance of family conflict is 0.000 ($P < 0.05$), which means that the two variables, both the independent variable (forgiveness) and the dependent variable (family conflict) are not normally distributed, then it is said that the normality assumption test is not fulfilled. While the linearity test, namely the table of linearity test results above, it is known that the significance value is 0.000 ($P < 0.05$), it can be stated that the two research variables are declared linear.

The normality test results are not normally distributed, so test the hypothesis using the Wilcoxon Test and Determination Test (R-Square). The Wilcoxon test is a non-parametric test used to analyze data that is not normally distributed and is used for the interval or ordinal-type data. The Wilcoxon test guidelines are if the sig. (2-tailed) < 0.05 , so there is an effect of forgiveness on interpersonal conflict (Hypothesis accepted).

Test Statistics^a

	Konflik Keluarga - Pemaafan
Z	-8.982 ^b
Asymp. Sig. (2-tailed)	.000

a. Wilcoxon Signed Ranks Test

b. Based on positive ranks.

Based on the results of the table above, the significance value is 0.000 ($P < 0.05$), which means that there is an influence between forgiveness and family conflict. Based on the results of the determination test in the table above, it is known that the R Square value is 0.202, this indicates that forgiveness has a 20.2% effect on family conflict, which means forgiveness influences family conflict, while the rest is influenced by other variables that are not examined in this study.

Discussion

Forgiveness aims to dispel years of negative emotions into positive emotions that can improve mental health. Research reports that forgiveness can improve psychological well-being (Maulida & Sari, 2016), and improve mental health (Raj, Elizabeth & Padmakumari, 2016). increasing interpersonal trust in friendships (Utami, 2015), self-maturity (Sumiati & Sandjaja 2013), and increasing self-acceptance (Rahmandani & Subandi, 2010).

According to Worthington (2010) the key to forgiveness is confronting emotions related to unpleasant experiences, resolving unfinished situations, and then releasing negative emotions towards those who hurt. Therefore, therapy that is considered theoretically suitable for increasing forgiveness is a therapy that invites individuals to reconstruct past experiences in order to attack emotions related to unpleasant experiences. So researchers use psychodrama as one of the facilities of forgiveness therapy.

The perspectives of parents and children on conflicts and disagreements between them are often different. Parents always see from the point of view of parental authority and social order. In dealing with disagreements with children, parents often justify their point of view based on their authority as parents and social rules (Smetana, 2004). Seeing this perspective, parents consider conflicts to be resolved when teenagers agree and follow their parents' opinions. Therefore, in general, parents often assess that their relationship with their children is fine and that conflicts between them are not too loud and frequent. However, from the child's

point of view, obeying or obeying the parents' opinion after differences, opposition, or conflicts does not always mean that the conflict is over. Because of this, to reduce family conflict, forgiveness is needed to create a harmonious family.

Based on the results of the determination test, it is known that the R Square value is 0.374, this indicates that forgiveness has a 37.4% effect on interpersonal conflict, which means that forgiveness affects family conflict, while the remaining 62.6% is influenced by other variables that are not examined in this study. Possible variables that can affect family conflict are in the aspects of religion, economy, and education, so that they can be a reference for further research.

CONCLUSION

The results of the study show that there is an effect of forgiveness on family conflict. The data obtained shows that forgiveness has an effect of 37.4% on family conflict, which means that forgiveness has an influence on family conflict, while the remaining 62.6% is determined by other variables not examined.

Finally, the researcher would like to thank all parties who supported this research until the end.

REFERENCE

- Gil, E. (2009). *Outgrowing the Pain: A Book for and about Adults Abused as Children*. New York: Dell Publishing.
- Hasibuan, Rahmayani. 2016. *Dampak Konflik Keluarga terhadap Perilaku Remaja di Desa Sibuhuan Julu Kecamatan Barumun*
- Lestari, sri. 2016. *Psikologi Keluarga*. Jakarta: kencana
- McCullough, M. E. Pargament, K. I. dan Thoresen, C. E., (2001). *Forgiveness: Theory, Reseach, and Practice*. New York: The Guilford Press
- Maulida & Sari. 2016. Hubungan Memaafkan dengan Kesejahteraan Psikologis Pada Wanita yang Bercerai. *Jurnal Ilmiah Mahasiswa Psikologi Vol. 1, No. 3 : 7-18*
- Mullet,M.,Neto,F.,&Riviere,S. (2005). *Personality and its Effects on Resentment, Revenge, Forgiveness and Selfforgiveness*. Worthington,E.L.NewYork:Routledge.
- Raj,P.,Elizabeth,C.S.,&Padmakumari,P. (2016). Mental Health through Forgiveness: Exploring the Roots and Benefits. *Cogent Psychology 3,2-16*.
- Smetana. (2004). Adolescent-parent-conflict: Resistance and subversions as developmental process. In L. Nucci (ed). *Conflict, contradiction and cosnstrarian elements in moral development and education*. Mahwah, NJ: Lowrence Erlbaum Associates.
- Sumiati, I & Sandjaja, S.S. (2013). Hubungan Antara Memaafkan dengan Kematangan Diri Pada Remaja Akhir. *Jurnal NEOTIC Psychology, 3(2), 144-162*
- Thompson, dkk. (2005). Dispositional Forgiveness of Self, Others and Situation. *Journal Personality 73(2),313-360*
- Worthington,E.L.(2007). Forgiveness,Health and Well-being: A Review of Evidence for Emotional Versus Decisional Forgiveness and Reduced Unforgiveness. *Journal Behavior Med 30 (4),291-30*.
- Worthington,E.L.(2010). Forgiveness and Sprituality in Organizational Life:Theory, Status of Research and New Ideas for Discovery. *Journal of Management, Sprituality and Religion 7 (1),119-134*.

Self-Reliance, Simple Living, and Happiness in the Man Who Quit Money

Khairul Hisyam Baharuddin
Universiti Malaysia Kelantan
khairulhisyam@umk.edu.my

Nazatul Syima Mohd Nasir
Universiti Malaysia Kelantan
syima.mn@umk.edu.my

Fairuz A'dilah Rusdi
Universiti Malaysia Kelantan
fairuz@umk.edu.my

ABSTRACT

For some, self-reliance, happiness and simple living form the basis of their living. For others, helping the less fortunate and vulnerable people within their communities and selflessness are the foundation of their lives. Different theories have been proposed in literature to explain the two concepts of living. The simplistic voluntary lifestyle (VSL) is an oppositional strategy of living, which discards excessive consumption and materialistic culture characterizing consumer lifestyles. VSL involves the transition from the consumption-driven lifestyle to intrinsically satisfying pursuits. his kind of life is contrary to the capitalist culture, characterized by overconsumption and environmental degradation. Emerson's theory of self-reliance and voluntary simple living theories encourage individuals to practice a sense of independence. In the novel, 'The Man Who Quit Money,' the character Suelo shuns the capitalist way of life and living happily without the material things that make people happy. Capitalism leads to increased consumption and environmental degradation. On a personal level, it causes social divisions and competitiveness. It also causes people to forget about their spiritual responsibility to take care of each other.

Keywords: *voluntary simplistic lifestyle, the man who quit money, self-reliance, life happiness, simple living*

ABSTRAK

Bagi sesetengah orang, berdikari, kebahagiaan dan kehidupan sederhana menjadi asas kehidupan mereka. Bagi yang lain, membantu orang yang kurang bernasib baik dan terdedah dalam komuniti mereka dan sikap tidak mementingkan diri adalah asas kehidupan mereka. Teori yang berbeza telah dicadangkan dalam kesusasteraan untuk menjelaskan dua konsep kehidupan. Gaya hidup sukarela yang ringkas (VSL) ialah strategi hidup yang bertentangan, yang membuang penggunaan berlebihan dan budaya materialistik yang mencirikan gaya hidup pengguna. VSL melibatkan peralihan daripada gaya hidup yang didorong oleh penggunaan kepada usaha yang memuaskan secara intrinsik. jenis kehidupannya bertentangan dengan budaya kapitalis, dicirikan oleh penggunaan berlebihan dan kemerosotan alam sekitar. Teori berdikari Emerson dan teori hidup mudah sukarela menggalakkan individu mengamalkan rasa berdikari. Dalam novel, 'The Man Who Quit Money,' watak Suelo menjauhi cara hidup kapitalis dan hidup bahagia tanpa benda material yang menggembirakan orang. Kapitalisme membawa kepada peningkatan penggunaan dan kemerosotan alam sekitar. Pada peringkat peribadi, ia menyebabkan perpecahan sosial dan daya saing. Ia juga menyebabkan manusia lupa akan tanggungjawab rohani mereka untuk saling menjaga.

INTRODUCTION

With the increasing costs of living across the globe today and the need to make ends meet, people increasingly believe that leading simple and self-reliant lifestyles is complicated and old fashioned. However, for others, self-reliance, happiness, and simple living form the basis of their living. For such people, helping the less fortunate and vulnerable people within their communities and selflessness form the basis of their lives. Self-reliance encompasses being true to oneself and exercising such virtues as responsibility, discipline, and confidence while remaining connected to one's cultural roots. On the other hand, simple living involves engaging in different types of voluntary activities to simplify one's lifestyle.

Different theories have been proposed in contemporary literature to explain the two concepts of living. Emerson's self-reliance theory explains how individuals live by their cultures while remaining virtuous, while the voluntary simplistic lifestyle theory explains how individuals live simple lives. This paper uses the two theories to analyze self-reliance, happiness, and simple living in the novel, *The Man Who Quit Money*.

METHOD

The Emerson self-Reliance Theory

Emerson's theory of self-reliance has been used in explaining how people achieve happiness by being true to themselves and promoting better living within the community (Chari, 304). The theory formed the central subject of the American Transcendentalist movement. Today, the theory is considered to be one of the most influential formulations of individualism in the United States.

In his theory, Emerson describes self-reliance as the idea of living in which an individual defies all the preceding principles. He encourages individuals to exercise free will to discard conformity constraints and embrace nature (Liang 1352). The theorist posits that in nature, everything occurring harmoniously with divine providence. He asserts that people cut themselves off from the conventions that define life by conforming to the existing social bonds. According to this theorist, people should step up from customary thoughts attributed to the societal rigidity and are guided by spirit in their lives. He further states that for people to gain their sense of independence, there is the need to abandon all that has been learned, seek the firsthand knowledge, and make it their truth (Kouassi 90). This means that individuals should go back to living in their cultures.

Although the language used by the theorist in expressing his views is not humble, he clearly shows that acting on personal decisions places individuals above the masses (Liang, 1353). He states that all people have the potential to optimize their self-esteem, and no one is superior to others. He further reveals that anyone can achieve happiness since it requires an alteration in the mental pattern of an individual.

The Theory of Voluntary Simplicity

The notion of voluntary simplicity has been used to explain the concept of simple living. According to Alexander and Ussher (68), overconsumption in the world's affluent societies has been associated with a myriad of adverse outcomes. These include consumer malaise, environmental degradation, and increased levels of global poverty. Transition to a more sustainable society, therefore, requires people to move from lifestyles guided by enormous consumption patterns to more ecological and simple living.

The simplistic voluntary lifestyle (VSL) is well-defined as an oppositional strategy of living, which discards excessive consumption and materialistic culture characterizing consumer lifestyles (Osikominu and Bocken 3). The VSL notion involves the transition from the consumption-driven lifestyle to intrinsically satisfying pursuits. To successfully meet their simple living desires, people who practice this living strategy aim to provide for their material needs in a simple and direction approach to minimize spending and effort when pursuing nonmaterial satisfaction (Saygil and Erkan 243). In most cases, it involves acceptance of lower-income and low levels of satisfaction in exchange for more free time. However, for other people, simplistic voluntary lifestyle means opposing the current high consumer lifestyles and pay systems and directing time and energy on helping the vulnerable and less fortunate in the society without expecting anything in return. Such people live simple and sustainable lives and only accept non-monetary gifts from people instead of working to earn rewards or recognition. Finally, individuals who practice the VSL are commonly found in Western societies and are often well educated and capable of meeting their basic needs. They, however, choose this path for their spiritual and self-satisfaction.

RESULTS

Self-Reliance and Simple Living in the Novel

One principle of both Emerson's theory of self-reliance and the simplistic voluntary theory is the conservation of the environment. While nature provides almost everything that man needs to survive, the overuse and overconsumption of natural resources caused by human beings have resulted in environmental degradation and other problems currently faced by many people worldwide (Liang 1352). Both the self-reliance theory and the voluntary simplistic lifestyle models oppose overconsumption and encourage people to seek happiness by exercising a sense of responsibility for nature through reduced consumption.

The promotion of environmental conservation by disregarding the culture of consumption in the novel, 'The Man Who Quit Money,' can be seen throughout the self-reliant and simple life of Suelo. At the age of 39, he discards all his money by placing it in a telephone booth and begins to live a life without money. Unlike modern Americans who overuse nature's resources in the construction of houses and engage in unsustainable consumption, Daniel Suelo leads his life as a steward of nature. He lives in a small cave in Utah's canyonlands where wild animals and fruits, and picks expired groceries from dumpsites forages. Throughout this journey, he does not engage in any form of environmental degradation. He says, "My philosophy is to use only what is freely given or discarded and what is already present and running" (Sundeen 10). With this kind of life, he remains attached to nature and does everything within his capacity to conserve it.

Compared with the lives of other Americans, Suelo's life is considered to have a lower impact. Considering that he lacks vehicle and home ownership, his carbon dioxide production is insignificant. The other activities that he engages in, such as foraging wild fruits and spearfishing salmon imposes zero environmental costs as there is no production or transportation. He also rescues processed food from the trash cans preventing the expenditure of energy and disposal in landfills. Moreover, he does not also use wrappers, plastic bottles, and cans. To illustrate Suelo's passion for nature, his friend Damian Nash says, "He desires to have the smallest ecological footprint and the largest impact in improving the world" (Sundeen 21). He further reports that Suelo's goals is to make little gains while giving as much as possible. This kind of life is contrary to the capitalist culture, which is characterized by overconsumption and environmental degradation.

Secondly, Emerson's theory of self-reliance and voluntary simple living theories encourage individuals to practice a sense of independence. With the current dependence on money and the complicated lifestyles that many Americans live, it is difficult for people to engage in simple living and self-reliance due to the societal norms. Today, people believe that the key to individual happiness has luxurious lifestyles with a lot of money at the disposal of individuals, and people who have contrary opinions or beliefs are considered backward and outdated. The two theories encourage individuals to live their lives in a manner that brings self-satisfaction and happiness regardless of the societal norms. Emerson's theory of self-reliance argues that for one to achieve self-reliance, people should cut themselves from societal conventions that cause rigidity and exercise a sense of independence. Similarly, the VSL theory asserts that people who adopt this lifestyle are educated folks who seek happiness in independent thinking.

In the novel, 'The Man Who Quit Money,' the character Suelo exercises independence as proposed by the two theories by shunning the capitalist way of life and living happily without the material things that make people happy. At 39, when the capitalist system requires individuals to acquire wealth and invest in various economic activities, David Suelo discards his remaining amount of money that he has and begins to live a life with no money (Sundeen 19). This kind of life is contrary to the capitalist culture in which people use the money to make purchases of basic needs such as food, clothing, and shelter. When the ranger from the Bureau of Land Management found the canyon land in Utah, which is considered government property, his sense of independence and detachment from the use of money comes into play. When asked to evict the land, he asks, "Are you saying this because you are paid, or do you believe it?" (Sundeen 18). With this statement, he tries to show the ranger that he should not just follow orders but think independently. Through his sense of independence, he can influence the ranger who decides to separate his personal and professional opinions and acknowledges the excellent work Suelo is doing in the canyon land.

His sense of independence is also shown by the fact that he does not use money even though he lives in a capitalist system where the use of money is the norm. When met by the ranger who accuses him of trespassing and hands him a ticket of \$120, he says confidently, "I don't use money, I can't pay for this" (Sundeen 19). According to the author, David Suelo does not only use money but has discarded his driver's license and passport and uses the name Suelo, which stands for soil instead of his surname. He even questions the judge on the laws such as the fourteen-day camping limit, which he believes keeps people like him from existing. Suelo is practicing a life of independence as proposed by Emerson's concept of self-reliance and the voluntary simplistic lifestyle theory.

Another essential idea of self-reliance and simple living proposed by the two theories is volunteerism. Stukas, Snyder, and Clary (28) define volunteering as a prosocial behavior in which individuals choose freely to commit a substantial amount of time and effort to help a person, group of people, of course without expecting any financial rewards. People who engage in volunteerism understand the difficulties that other people, especially the vulnerable members of the community, go through and use their time and effort to help in improving the lives of these vulnerable people. In a capitalist society, people believe in working to make money and mostly consider the less fortunate in society as unable to work for pay. Capitalism, therefore, does not encourage volunteerism. Emerson's theory of self-reliance and the notion of a simplistic voluntary lifestyle hold that happiness can be attained by helping others without expecting anything in return.

Throughout his new life journey, Daniel Suelo lives a life of volunteerism, contrary to the capitalist culture, which requires people to make and spend money. Throughout the novel, Suelo uses all that he has to promote the welfare of others through volunteerism ((Sundeen 20). His volunteer activities can be seen through the way he offers help to organizations and people

who are less privileged in the society by cooking for them and sharing his time and belongings with them. For instance, when he is away from his cave in Utah, which attracts hikers during the warm months, he allows them to use his camp freely without charging them for anything. He leaves notes behind saying, *'Feel free to camp here, what is mine is yours. Eat any of my food and read my books. Take them with you if you like.'* (Sundeen 18) When taken to the judge for violation of the law which requires people to stay out of the public property, his love for helping others manifests again. When asked by the judge what kind of punishment he should be given, he suggests volunteering at a facility sheltering abused women and children. He has volunteered in this organization several times and does not have difficulties doing it. When volunteering in such organizations, he does not accept any form of pay or reward but can accept gifts and hospitality. His ability to perform volunteer work for years without expecting any form of payment in return proves that he lives a self-reliant and simple life away from the social beliefs on capitalism.

Moreover, capitalist culture holds that money and material wealth is the source of happiness for individuals and that pursuing spiritual growth and other forms of fulfillment is a way of inviting poverty (Butler, 2018). Today, many people in the United States work hard to accumulate material wealth as a form of satisfaction. The use of money as a currency further aggravates the situation. It robs them of happiness since they have to purchase everything they have, including medical services, the homes in which they stay, the food they eat, and the clothes they wear (Ahuvia 201). When people have no money, they borrow from friends and financial institutions, ending up in debts. The monetary system has resulted in the creation of social classes that have caused discrimination and disorder in almost all parts of the country. The sense of unity and equality has declined, and people are increasingly fighting poverty by working hard and accumulating wealth. Although money can determine individuals' lives, it does not necessarily generate happiness (Sengupta et al. 23). The theory of simplistic voluntary living and Emerson's concept of self-reliance encourages individuals to attain happiness from pursuing a better spiritual life rather than material things.

Although Suelo does not have or use money, he lives a life of fulfillment, which is guided by his spiritual beliefs. Although Suelo was brought up in a Christian family, he currently leads a life with no religion. His spiritual beliefs are influenced by his readings from holy texts from different religions and the works of philosophers such as Thoreau, Gandhi, and Tolstoy. He says, "All these separate and distant scriptures and authors agree that the only way of truth is non-possession" (Sundeen 26). He even quotes what different Holy Scriptures say about possession and the use of money. According to Suelo, the monetary system has corrupted people in his country and resulted in divisions that would otherwise not have existed.

Moreover, he states that many people have been led by the illusion that money can help them control their past and future, causing them to forget about their spiritual fulfillment. This way, the capitalist system denies people the happiness that they deserve. To break from this societal control and live a simple but fulfilling life, Suelo stops using money and ceases having any possessions.

CONCLUSION

From the novel, American society today is designed in such a way that individuals need money and become a key component of the capitalist system. However, this kind of lifestyle is associated with adverse effects not only on individuals but also on society. First, capitalism leads to increased consumption and environmental degradation. On a personal level, it causes social divisions and competitiveness, leading to increased vices and causes people to forget about their spiritual responsibility to take care of each other. While development is essential in

the current world, people need to be confident and move away from the cultures and beliefs in the societies in which they live to attain happiness through self-reliance and simplicity.

REFERENCES

- Ahuvia, Aaron, Chaim. *Consumption, Income and Happiness*. The Cambridge Handbook of Psychology and Economic Behaviour. US: Cambridge University Press. 2017.
- Alexander, Samuel and Ussher, Simon. The Voluntary Simplicity Movement: A multi-national survey analysis in theoretical context. *Journal of Consumer Culture*, vol 12, no.1 2012, pp. 66-86.
- Butler, Stephen. The Impact of Advanced Capitalism on Well-being: an Evidence-Informed Model. *Human Arenas*, vol 2, 2018, pp. 200-227.
- Chari, Naduri, S. Ralph Waldo Emerson's Philosophy of Individuality: An Inspiration. *Research Journal of English Language and Literature (RJELAL)*, vol 2, no. 1, 2014, pp. 303-310.
- Einolf, Christopher and Chamre, Susan M. Who volunteers? Constructing a hybrid theory. *International Journal of Nonprofit and Voluntary Sector Marketing*, vol 16: 298-310. 2011.
- Kouassi, Jerome. Understanding Emerson's Self-Reliance in Terms of Education with a Focus on Language Didactics. *HSS Journal*, vol 4, no.3 2015, pp. 90-96.
- Liang, Haijing. An Eye for an —II -- An Insight into Emerson's Thought of Self-reliance. *Journal of Language Teaching and Research*, vol 4 , no.6, pp. 1351-1355.
- Osikominu, Jessica and Bocken, Nancy. A Voluntary Simplicity Lifestyle: Values, Adoption, Practices and Effects. *Sustainability*, vol 12, 2020, pp.2-30.
- Saygil, Metin and Bil, Erkan. The Investigation of Voluntary Simplicity Lifestyle from the Point of Personality Characteristics: A Research on Clothing Product Group. *Journal of Life Economics*, vol 30, no. 31, 2017, pp. 240-250.
- Sengupta, Nikhil.K, Osborne, Danny, Houkamau, Carla.A, Hoverd, William James, Wilson, Marc Stewart, Halliday, Lara.M. et al. How much happiness does money buy? Income and subjective well-being in New Zealand. *New Zealand Journal of Psychology*, vol 41, no.2, 2012, pp. 22-28.
- Stukas, Arthur, Snyder, Mark and Clary, Gill, E. Volunteerism and community involvement: Antecedents, experiences, and consequences for the person and the situation. In D. A. Schroeder & W. Graziano (Eds.), *The Oxford handbook of prosocial behavior*. New York: Oxford University Press. 2014.
- Sundeen, Mark. *The Man Who Quit Money*. New York: Penguin Incorporation. 2012.

MALAYSIA

KELANTAN

Teori Ijtihad Maqasidi dalam Pengeluaran Fatwa: Analisis Al-Dharuriyyat Al-Khams
Ijtihad Maqasidi Theory in Issuing Fatwa: Analysis of Al-Dharuriyyat Al-Khams

Muhammad Mustaqim Bin Roslan
Fakulti Pengajian Islam & Sains Sosial, Universiti Sultan Azlan Shah (USAS)
Email: muhd.mustaqim@usas.edu.my

Mohd Aliff Haiqal Bin Mhd Suhaimi
Fakulti Pengajian Islam & Sains Sosial, Universiti Sultan Azlan Shah (USAS)
Email: carl95laksamana@gmail.com

ABSTRACT

The term Ijtihad Maqasidi is not an awkward and foreign term for students of Usul Fiqh. This is because the role of maqasid in ijti had must always be accompanied in all matters of fatwa and ijti had. The scholars of motion have produced many scientific quotations in discussing the role and importance of Maqasid Syariah in ijti had. However, there are some fatwas that seem to be lacking in emphasizing al-Dharuriyyat al-Khams in Maqasid Syariah and thus ultimately cause an impact on Muslims worldwide. Therefore, this article highlights the main objective, which is to identify the theory of Ijtihad Maqasidi that needs to be considered by mujtahids in issuing fatwas. The philosophy behind this article is "Interpretive" and uses a "Qualitative" approach in adapting the research design. The method of data collection and analysis is "Document Content Analysis" by analyzing the main samples from provisions in the Quran and Sunnah. It is used as primary data in this study because the data is from a direct, authoritative source and is not influenced by any individuals' view or opinion. In addition, the secondary data for this study is the debate found in books of interpretation, academic books, journals, and past scientific studies used in this article. The results of the findings show that the understanding of the text by applying the five aspects of al-Dharuriyyat al-Khams in Maqasid Syariah i.e. Hifz al-Din, Hifz al-Nafs, Hifz al-'Aql, Hifz al-Nasl and Hifz al-Mal is the main theory in Ijtihad Maqasidi. Therefore, the parties in authority must always be careful in understanding the text of the syarak so that the issuing of fatwas is more harmonious with the concept of Ijtihad Maqasidi.

Keywords: *al-Dharuriyyat al-Khams, fatwa, ijti had, Maqasid Sharia, theory.*

ABSTRAK

Istilah Ijtihad Maqasidi bukanlah satu istilah yang janggal dan asing bagi penuntut ilmu Usul Fiqh. Ini adalah kerana peranan maqasid dalam ijti had itu tidak dapat tidak mestilah sentiasa didampingi dalam semua hal ehwal fatwa dan ijti had. Para sarjana usul telah banyak menghasilkan pelbagai nukilan ilmiah dalam membincangkan peranan mahupun kepentingan Maqasid Syariah dalam ijti had. Namun begitu terdapat sesetengah fatwa yang nampaknya kurang meraikan hal al-Dharuriyyat al-Khams dalam Maqasid Syariah dan akhirnya memberikan kesan kepada umat Islam sejagat. Oleh yang demikian artikel ini mengetengahkan objektif utama iaitu mengenal pasti teori Ijtihad Maqasidi yang perlu dipertimbangkan oleh mujtahid dalam pengeluaran fatwa. Falsafah di sebalik artikel ini ialah "Interpretif" dan menggunakan pendekatan "Kualitatif" dalam mengadaptasikan reka bentuk kajian. Kaedah pengumpulan dan analisis data ialah "Analisis Kandungan Dokumen" dengan menganalisis sampel utama daripada peruntukan dalam al-Quran dan al-Sunnah. Ia dijadikan sebagai data primer dalam kajian ini kerana data tersebut adalah daripada sumber langsung, berautoriti

dan tidak dipengaruhi oleh mana-mana pandangan atau pendapat individu. Selain itu juga, data sekunder bagi kajian ini ialah perbahasan yang terdapat dalam kitab-kitab tafsir, buku-buku akademik, jurnal dan kajian ilmiah lepas digunakan dalam artikel ini. Hasil dapatan menunjukkan bahawa pemahaman nas dengan menerapkan lima hal al-Dharuriyyat al-Khams dalam Maqasid Syariah iaitu Hifz al-Din, Hifz al-Nafs, Hifz al-'Aql, Hifz al-Nasl dan Hifz al-Mal merupakan teori utama dalam Ijtihad Maqasidi. Oleh yang demikian, pihak-pihak berautoriti perlulah sentiasa berhati-hati dalam memahami nas syarak agar pengeluaran fatwa yang dilakukan adalah lebih harmoni berkonsepkan Ijtihad Maqasidi.
Kata kunci: al-Dharuriyyat al-Khams, fatwa, ijtihad, Maqasid Syariah, teori.

PENDAHULUAN

Sebagai seorang mujtahid yang mempunyai autoriti dalam melakukan proses istinbat dan pengeluaran hukum-hakam, mereka tidak akan terlepas dari teori-teori ijtihad yang akan mereka aplikasikan dalam hal-ehwal berfatwa. Sekiranya teori mahupun langkah ijtihad itu sedikit berbeza dengan para mujtahid yang lain, maka kesannya akan tetap terpalit walaupun hanya perbezaan dalam menggunakan sumber istinbatnya sahaja. Apatah lagi sekiranya mereka itu berbeza terus dalam penggunaan kaedah terhadap pengeluaran hukum-hakam. Para mujtahid masing-masing mempunyai teori tersendiri dalam berijtihad. Sekiranya mereka berbeza dalam sumber asas dan teori ijtihad, maka berbezalah hukum-hakam yang dikeluarkan oleh mereka.

Yang pastinya, mereka tidak boleh terkeluar daripada konsep-konsep asas ijtihad. Sekiranya tersasar, maka barangkali akidah mereka juga turut memberikan kesan. Oleh itu, pertimbangan yang menjadi kayu pengukur ini semestinya berlandaskan nilai-nilai al-Quran dan al-Sunnah yang menjadi asas bagi memastikan ia berada dalam kerangka syariat (Hasbollah Mat Saad 2021). Sebagai contohnya apabila seseorang muhtahid itu berijtihad dalam hal ehwal nas yang telah qatie' di dalam al-Quran dan al-Sunnah seperti hukum solat dan berpuasa. Apabila sesuatu nas itu telah kekal dan tetap secara qathie' di dalam al-Quran dan al-Sunnah, mana mungkin pintu ijtihad itu terbuka ke atasnya. Jika tidak, proses ijtihad akan tersasar jauh dari medan dan landasannya. Selain daripada itu juga, proses ijtihad melalui pemahaman nas dengan saduran Maqasid Syariah adalah sangat penting dalam pengeluaran fatwa. Ia disebut sebagai Ijtihad Maqasidi yang menjadi perbincangan utama dalam artikel ini. Secara khususnya, artikel ini akan menjawab satu persoalan sahaja iaitu:

1. Apakah teori *Ijtihad Maqasidi* dalam pengeluaran fatwa?

SOROTAN DAN METODOLOGI

Penulis telah menyoroti beberapa kajian lepas yang berlegar di bawah skop Ijtihad Maqasidi bagi memperkukuhkan lagi perbincangan artikel ini. Pertamanya penulis mulakan dengan kajian yang bertajuk "***Pemakaian Elemen Maqasid Syariah dalam Institusi Fatwa di Malaysia***" oleh Nora'inan Bahari pada tahun (2020). Kajian ini menggunakan reka bentuk kualitatif dan mengambil fatwa-fatwa bermula pada tahun 1970 hingga 2015 sebagai sampel kajian. Secara umumnya, kajian ini mengukur sejauh mana keberhasilan pemakaian konsep Maqasid Syariah dalam institusi fatwa di Malaysia. Hasil dapatan menunjukkan penggunaan elemen Maqasid Syariah mampu memberikan kesan yang lebih baik dan berkesan dalam menetapkan hukum serta fatwa yang akan diputuskan. Secara dasarnya kajian ini mempunyai persamaan pada sudut perbincangan penulis iaitu Maqasid Syariah, namun penulis tidaklah berfokus kepada mana-mana fatwa tertentu untuk dinilai penerapan maqasidnya.

Seterusnya ialah kajian Rabiatul Adawiah (2019) berjudul **“Maqasid Syariah dalam Urus Tadbir”** turut disoroti penulis dalam artikel ini. Kajian ini menggunakan pendekatan kualitatif dan bertujuan untuk melihat sejauh mana keberkesanan urus tadbir yang berasaskan elemen atau prinsip yang berlandaskan Maqasid Syariah. Hasil dapatan menunjukkan bahawa urusan pentadbiran menjadi lebih mudah, tersusun dan teratur apabila meletakkan al-Quran dan al-Sunnah sebagai tunjang utama. Ini membuktikan Islam lebih efektif dan fleksibel diamalkan sepanjang zaman dalam apa jua bidang dan urusan. Kajian ini mempunyai perbezaan yang agak ketara dengan perbincangan artikel ini kerana ia menganalisis aplikasi Maqasid Syariah dalam urus tadbir bahkan penulis hanyalah berfokus kepada penerapannya dalam fatwa.

Adapun yang terakhir ialah kajian Alias Azhar pada tahun (2017) bertajuk **“Penyelidikan Fatwa dalam Kerangka Maqasid al-Syariah: Satu Tinjauan”** turut disoroti penulis dalam perbincangan artikel ini. Kajian ini mengadabtasikan reka bentuk kualitatif dan bertujuan untuk melihat sejauh mana kerangka Maqasid Syariah itu dapat digunakan dalam istinbat hukum bagi mengemukakan fatwa yang lebih memberi kesan serta sistematik. Hasil dapatan menunjukkan bahawa pelbagai isu baru yang memberikan kesan buruk mampu diatasi dan diharmonikan dengan menerapkan Maqasid Syariah dalam satu-satu hukum agar ia lebih inklusif. Kajian ini adalah berfokus kepada fungsi Maqasid Syariah itu sendiri dalam penyelidikan fatwa, bahkan artikel ini membincangkan lebih khusus terhadap dharuriyyat al-Khams dalam Ijtihad Maqasidi.

Selain daripada artikel-artikel lepas yang telah disoroti penulis, perincian berkaitan dengan metodologi kajian dalam menyelesaikan artikel ini turut dihuraikan agar hasil dapatan mencapai objektif dan persoalan kajian. Metodologi kajian merupakan perancangan umum bagaimana sebuah kajian itu ingin dijalankan dengan menghasilkan dapatan yang berkualiti untuk dimanfaatkan bersama (Siti Adibah & Siti Zubaidah, 2018). Oleh itu, penulis telah mengatur metodologi kajian dan strategi-strategi yang telah digunakan untuk mendapatkan maklumat dan data melalui kaedah-kaedah tertentu daripada tiga aspek penting iaitu reka bentuk kajian, kaedah pengumpulan data dan kaedah analisis data.

Menurut Creswell (2009), reka bentuk kajian adalah rancangan atau cadangan bagi menjalankan kajian melibatkan interaksi antara falsafah kajian, strategi penyelidikan dan metod kajian. Oleh itu, falsafah disebalik kajian penulis ini adalah **“Interpretif”** iaitu berupaya untuk menjelaskan, memahami dan menafsirkan suatu makna dan simbol yang dimunculkan oleh responden dalam satu-satu realiti sosial yang dikaji (Rasalina 2017). Selain itu juga, kajian ini menggunakan pendekatan **“Kualitatif”** dalam mengadaptasi reka bentuk kajian. Menurut Miles dan Huberman (1994), kajian kualitatif ialah satu reka bentuk kajian yang berasaskan kepada *“by word”* dan *“picture”* atau satu kajian yang dibuat menggunakan huraian dan pelaporan secara varbetim (ayat demi ayat atau frasa demi frasa) tanpa sebarang cerapan statistik. Manakala kaedah pengumpulan dan analisis data pula penulis telah mengadabtasikan kaedah analisis kandungan dokumen dari kitab-kitab tafsir, buku-buku akademik, jurnal, kertas-kertas kerja persidangan dan kajian-kajian ilmiah lepas yang telah digunakan dalam artikel ini. Menurut Creswell, proses analisis data ini juga turut merupakan salah satu teknik khusus bagi kajian kualitatif (Creswell 2009).

PROSES IJTIHAD MELALUI PEMAHAMAN NAS DENGAN SADURAN MAQASID SYARIAH

Proses ijtihad melalui fahaman nas dengan saduran Maqasid Syariah bermaksud setiap proses ijtihad yang dilakukan mujtahid, prinsip asas Maqasid Syariah itu tidak boleh diabaikan dan

dihilangkan. Begitu juga menurut jumbuh ulama, mereka memahami al-Quran dan al-Sunnah tanpa mengabaikan Maqasid Syariah kerana setiap hukum-hakam pensyariat Allah itu terdapat maqasid utama samada diketahui secara langsung ataupun tidak. Tambahan lagi, maqasid itu sendiri ialah tujuan dan makna yang telah digariskan oleh syarak dalam setiap perundangan sama ada secara umum atau khusus bagi memelihara kepentingan manusia (Al-Qaradawi 2000). Dan hal ini bukanlah suatu perkara yang baharu diperkenalkan oleh ulama kontemporari. Sebagai contohnya penulis datangkan hadis Ibnu Umar bahawasanya nabi Muhammad itu pernah bersabda yang bermaksud:

“Janganlah seseorang dari kamu solat Asar kecuali di Bani Quraizhah”. (H.R. Bukhari: 894)

Daripada hadis ini, di sana terdapat dua perbezaan pendapat di kalangan sahabat dalam memahami nas tersebut. Golongan yang pertama memahami nas hanya pada zahirnya sahaja tanpa saduran Maqasid Syariah. Dan mereka berpendapat bahawa perintah nabi untuk menunaikan solat Asar itu hanya di Bani Quraizhah sahaja walaupun waktu Asar telah pun luput. Manakala golongan kedua pula daripada para sahabat memahaminya dengan melakukan solat Asar di pertengahan jalan sebelum terbenamnya matahari kerana mereka memahami maksud daripada nas itu ialah perintah agar sampai di Bani Quraizhah sebelum masuk waktu Maghrib dan solat Asar di sana. Pandangan kedua ini merupakan pendapat jumbuh ulama kerana terdapat saduran Maqasid Syariah dalam pemahaman nas. Solat merupakan tiang agama dan mana mungkin solat itu boleh diabaikan dan dilewat-lewatkan tanpa sebab yang patuh syariah. Penulis berpandangan bahawa pendapat pertama tidak terarah dalam menjaga prinsip asas pertama dalam Maqasid Syariah itu ialah *Hifz Ad-din* iaitu Menjaga Agama. Atas alasan itulah penulis menyokong bahawa pendapat kedua adalah hasil ijtihad yang menggunakan fahaman nas dengan saduran Maqasid Syariah.

Prinsip asas kedua dalam Maqasid Syariah itu pula adalah *Hifz An-Nafs* iaitu Menjaga Jiwa, Diri, Nyawa dan seangkatan dengannya. Di dalam al-Quran mahupun al-Sunnah, di sana terdapat begitu banyak nas yang menasihati umat manusia agar sentiasa menjaga diri dan jiwa dalam semua hal kehidupan. Pun begitu, setiap dalil yang termaktub itu tidaklah datang dari satu gaya bahasa sahaja. Setiap mujtahid mestilah memahami nas-nas tersebut dengan kaedah tertentu agar maksudnya tidak dibatasi dengan satu-satu maksudnya sahaja. Oleh kerana itulah sumber qiyas dijadikan antara teori utama dalam mengeluarkan sesuatu hukum dari dimensi yang berbeza. Bukan itu sahaja, bahkan setiap nas tersebut mestilah difahami dengan saduran Maqasid Syariah. Sebagai contohnya seperti mana firman Allah dalam surah Al-An'am, ayat 151 yang bermaksud:

“Hendaklah kamu berbuat baik kepada dua ibu bapa. Janganlah kamu membunuh anak-anak kamu kerana kepapaan. Kamilah yang memberi rezeki kepada kamu dan kepada mereka. Janganlah kamu hampiri perbuatan-perbuatan keji seperti zina, sama ada yang terang ataupun yang tersembunyi. Janganlah kamu membunuh jiwa yang telah diharamkan oleh Allah, melainkan dengan hak dibenarkan oleh syarak. Itulah yang Allah perintahkan kamu dengannya, semoga kamu berakal dan mengerti.” (Q.S. Al-An'am: 6: 151)

Daripada ayat di atas, jelas perintah Allah itu ke atas larangan untuk membunuh jiwa-jiwa manusia tanpa kebenaran syarak. Ia bertepatan dengan prinsip asas kedua dalam hal *dharuriyat* yang mesti dijaga dalam Maqasid Syariah itu adalah *Hifz An-Nafs*. Allah selaku pencipta dan pemilik alam semester ini sangat menghalang keras bagi sesiapa yang membunuh diri sendiri apatah lagi membunuh orang lain. Ia dapat dilihat apabila hukuman balas dijadikan

sebagai balasan ke atas orang yang membunuh seperti firman Allah di dalam surah Al-Baqarah, ayat 178 yang bermaksud:

“Wahai orang yang beriman, diwajibkan atas kamu qisas iaitu hukuman setimpal berhubung orang yang dibunuh. Orang merdeka dibalas bunuh dengan sebab membunuh orang merdeka, hamba dengan hamba, dan wanita dengan wanita”. (Q.S. Al-Baqarah: 2: 178)

Namun begitu, para mujtahid tidaklah begitu sempit dalam memahami nas tersebut dengan hanya larangan membunuh diri sahaja, bahkan mereka memperluaskan maksudnya dengan larangan merosakkan jiwa dengan perkara-perkara yang boleh membahayakan jiwa dan nyawa manusia. Sebagai contohnya pengambilan sesuatu hidangan makanan yang telah diketahui akan mudharatnya pada diri seseorang. Adalah menjadi larangan syarak ke atas seseorang itu menikmati sesuatu hidangan tatkala telah diketahui akan alahan kepada sesuatu makanan itu sehingga boleh membawa maut walaupun makanan itu adalah halal di sisi syarak. Ia bertepatan dengan fahaman nas itu bukanlah hanya ditafsir dan diterjemahkan pada sudut zahirnya sahaja, bahkan mestilah diserap dengan prinsip Maqasid Syariah iaitu *Hifz An-Nafs*. Begitu jugalah dalam hal galakkan vaksin yang perlu diambil oleh bayi bagi mengelakkan mudarat ke atas bayi tersebut dan mudarat yang mungkin menimpa bayi lain, kesan daripada bayi tersebut yang tidak mengambil vaksin (Zulkifli al-Bakri 2019).

Prinsip asas *dharuriyat* yang ketiga pula dalam Maqasid Syariah itu adalah *Hifz Al-Aql* iaitu Menjaga Akal. Adalah menjadi larangan keras ke atas setiap umat manusia untuk merosakkan akal yang telah tuhan kurniakan kepada mereka. Ini kerana manusia itu dimuliakan dengan kurniaan akal supaya mereka dapat berfikir bagaimana untuk mentadbir kehidupan ini dalam keadaan yang tersusun dan teratur (Hidayat Kamaruddin 2000). Oleh yang demikian, apa jua perkara yang boleh merosakkan akal, ia adalah tidak selari dengan *Hifz al-Aql* dalam Maqasid Syariah. Tambahan lagi, kerosakkan akal atau akal yang telah diselubungi dengan perkara dan elemen yang tidak baik serta buruk akan mendatangkan satu kumpulan atau generasi ke arah melakukan kerosakan pada masa kemudian hari (Hasbollah Mat Saad 2021).

Di dalam kaedah usul pula, apabila terdapat larangan daripada Allah dari mana-mana nas syarak, maka ia akan menjadi Haram. Maka dengan itu, tidak kiralah apa jua tindakan yang boleh mengancam dan merosakkan akal manusia, ia turut menjadi haram. Begitulah dalam firman Allah ke atas pengharaman arak di dalam surah Al-Ma'idah, ayat 90 dan 91 yang bermaksud:

“Wahai orang yang beriman, sesungguhnya arak, judi, berhala-berhala dan batang-batang kayu yang lurus seperti anak panah tanpa mata dan bulu kemudi yang digunakan untuk tenung nasib itu adalah najis dan merupakan hasil daripada perbuatan syaitan. Oleh itu, hendaklah kamu menjauhinya semoga kamu berjaya”. (Q.S. Al-Ma'idah: 5: 90-91)

Firman Allah ini disokong pula di dalam hadis sahih yang diriwayatkan oleh Imam Ahmad, Muslim, Abu Daud, At-Tarmizi, An-Nasai dan Ibnu Majah yang bermaksud: Daripada Ibnu Umar, bahawa Nabi SAW bersabda: “Setiap benda yang memabukkan adalah arak. Setiap benda yang memabukkan adalah haram. Sesiapa yang meminum arak di dunia, lalu mati dalam keadaan menagihnya tanpa bertaubat, nescaya dia tidak akan meminumnya lagi di akhirat” (H.R. Muslim: 3733)

Larangan ini membuktikan kepada kewaspadaan syarak terhadap akal manusia. Sebab itulah Allah SWT telah meletakkan hukuman had yang begitu berat bagi sesiapa yang meminum arak tujuannya agar manusia sentiasa menjaga akal daripada rosak. Ia turut dijelaskan oleh Zulkifli al-Bakri (2017) melalui Fiqh al-Manhaji (Mustafa al-Khin 2011) bahawa haram meminum minuman yang memabukkan sama ada arak, iaitu yang dibuat daripada perahan anggur atau bukan arak, iaitu yang dibuat daripada benda lain. Berikut adalah dalil yang menjadi bukti bagi pesalah yang meminum arak seperti mana yang terdapat di dalam hadis yang diriwayatkan oleh Imam Muslim yang bermaksud:

Daripada Abu Sasan Hudhain bin Al-Munzir, katanya: “Saya telah hadir dan menyaksikan Al-Walid dibawa menghadap ‘Uthman bin ‘Affan, lalu Saidina ali berkata: ‘Wahai Abdullah bin Jaafar, bangunlah dan sebatlah dia’. Lalu Abdullah menyebatnya sambil Ali menghitung sehingga sampai 40 sebatan, lalu berkata: ‘Berhenti’. Kemudian, beliau berkata: ‘Nabi SAW telah menyebat peminum arak sebanyak 40 sebatan. Abu Bakar juga 40 sebatan. Umar pula 80 sebatan. Semua itu adalah Sunnah. Tetapi sebatan sebanyak 40 kali ini lebih aku sukai berbanding 80 sebatan’. (H.R. Muslim: 3220)

Daripada dalil-dalil yang telah didatangkan oleh penulis di atas, para mujtahid tidaklah begitu sempit dalam memahami nas tersebut dengan hanya larangan meminum arak sahaja yang menjadi haram ke atas manusia. Bahkan mereka mentafsir ayat tersebut dengan memasukkan saduran Maqasid Syariah sehingga melarang semua perbuatan yang boleh merosakkan akal manusia. Ini kerana setiap perbuatan yang mengancam dan membahayakan akal manusia adalah terkeluar daripada prinsip *Hifz Al-Aql* yang diinginkan oleh syarak.

Oleh itu, ia terbukti jelas dengan perbuatan yang merosakkan akal itu membuatkan seseorang telah bertentangan dengan *Hifz al-Aql* dan keharmonian islam itu sendiri (Hasbollah Mat Saad 2021). Sebagai contohnya larangan mengambil pil-pil khayal, menghisap rokok, menonton aksi-aksi yang boleh merosakkan akal dan sebagainya. Walaupun larangan itu tidaklah diharamkan secara qathie’ oleh Allah SWT di dalam kitabnya, namun pendekatan Maqasid Syariah itu telah membawa suatu tafsiran baru demi menjaga akal manusia bertepatan dengan prinsip *dharuriyat* dalam Maqasid Syariah.

Seterusnya hal *dharuriyyat* keempat dalam prinsip Maqasid Syariah itu adalah *Hifz al-Nasl* dan *Hifz al-Irdh* iaitu Menjaga Keturunan dan Menjaga Maruah. Di sana terdapat sebahagian ulama membezakan antara *Hifz al-Nasl* dan *Hifz al-Irdh* sehinggakan mereka mengasingkan keduanya dalam prinsip asas Maqasid Syariah menjadikan enam kesemuanya (Mustaqim Roslan 2012). Pun begitu penulis lebih selesa menggabungkannya sahaja dengan *Hifz al-Nasl* kerana penulis berpandangan bahawa perbahasan antara keduanya adalah hampir sama. Tambahan lagi, penulis melihat ahli-ahli sarjana usul terawal turut bersepakat dalam prinsip asas Maqasid Syariah itu hanyalah di bawah lima *dharuriyat* sahaja. Apapun perbezaan yang berlaku, mereka masih di bawah payung yang sama demi menjaga maslahat umum sejagat dan menghindari keburukan.

Islam sangat berwaspada dengan masalah keturunan penganutnya. Keturunan yang tidak jelas dan tidak patuh syariah akan memberikan kesan kepada delagasi kekeluargaan. Persengketaan dalam rumah tangga akan terkesan dek kerana kekhilafan dalam keturunan. Ia turut memberi kesan kepada hal ehwal pusaka, wasiat, perwalian dan sebagainya. Atas sebab itulah seseorang anak tak sah taraf adalah terputus hubungan daripada segi pusaka dengan bapanya tak sah taraf dan dia tidak menjadi ahli waris dan tidak berhak mewarisi pusaka bapanya dan sebaliknya (Mu’izz Abdullah 2021). Di dalam Al-Quran mahupun Al-Sunnah, di

sana terdapat pelbagai dalil mahupun nas yang menyeru umat manusia untuk menjaga kelestarian keturunan. Antaranya seperti firman Allah di dalam Surah al-Isra', ayat 32 yang bermaksud:

“Janganlah kamu menghampiri zina. Sesungguhnya ia adalah satu perbuatan yang keji dan ia seburuk-buruk jalan.” (Q.S. Al-Isra': 17: 32)

Ayat ini terang membuktikan akan larangan keras ke atas manusia untuk menghampiri dan mendekati zina. Sesungguhnya Allah SWT itu adalah maha bijaksana dan maha mengetahui. Sekalipun larangan itu hanyalah menjurus kepada sesiapa yang menghampirinya sahaja, namun esanya Allah dengan sifat maha mengetahui, sudah pasti ia akan membawa kepada perzinaan. Kesannya lahirlah anak-anak tidak berdosa yang berkecelaruan identiti mereka. Dan akhirnya merekalah yang menerima dan menanggung semua dosa ibu bapa mereka di luar sana. Bukan itu sahaja, tekanan yang tinggi terpaksa mereka hadapi di atas kesalahan orang lain akan membawa kecelaruan psikologi serta mendorong kepada sikap mudah berputus asa dalam meneruskan kehidupan (Abd Rahman Yaacob 2011). Daripada ayat di atas juga, larangan tersebut telah disokong di dalam Sunnah Nabi SAW yang mana Imam al-Tabrani meriwayatkan dalam al-Mu'jam Al-Kabir yang bermaksud:

“Daripada Syarik daripada Nabi SAW sabdanya: ‘Sesiapa yang berzina, nescaya iman keluar daripada dirinya. Tetapi, jika dia bertaubat, pasti Allah akan menerima taubatnya’”. (H.R. Abu Daud: 4690 & Tirmidzi: 2625)

Di dalam Islam, hukuman zinalah merupakan hukuman had yang paling keras sekali berbanding dengan kesalahan-kesalahan yang lain. Ini menjadi bukti bahawa larangan ini amat dicela dan dihina oleh Allah SWT. Perbuatan ini juga telah mencapai tingkat yang tertinggi kekejiannya bagi orang yang berakal. Bahkan memilih untuk melakukan perbuatan ini merupakan jalan yang buruk dan membawa ke arah kehancuran, kebinasaan serta kehinaan dunia juga azab di hari pembalasan (Ibnu Qayyim, 2007).

Bagi setiap muslim yang telah melakukan kesalahan zina, mereka dihukum mengikut status mereka iaitu *Muhsan* dan *Ghair Muhsan* (Asy-Syarbini 2004). Penzina *Muhsan* adalah bagi mereka yang pernah melakukan jimak dengan hubungan yang sah. Meneliti hubungan yang sah itu adalah membawa maksud kepada status perkahwinan yang sah diantara suami dan isteri (Fathi Yusof 2015). Sekiranya empat syarat ke atas mereka itu mencukupi, maka mereka berhak didakwa atas hukuman rejam sampai mati. Ini disokong oleh hadis sahih yang diriwayatkan oleh Imam al-Bukhari dalam kitab sahihnya yang bermaksud:

“Daripada Ibnu Abbas katanya: ‘Umar telah berkata: ‘Demi Allah, sesungguhnya saya takut masa yang panjang berlalu bersama orang ramai, sehingga seseorang daripada mereka boleh berkata: ‘Kami tidak dapati sebarang ayat yang mewajibkan hukuman rejam dalam kitab Allah, lalu mereka sesat kerana Allah. Ketahuilah, sesungguhnya rejam itu wajib ke atas sesiapa yang berzina dalam keadaan muhsan apabila bukti sudah cukup, atau berlaku mengandung, atau pengakuan. Sufian As-Sauri yang merupakan salah seorang perawi hadis ini berkata: ‘Beginilah saya menghafalnya. Umar berkata: ‘Ketahuilah, sesungguhnya Rasulullah telah merejam dan kami juga telah merejam selepas baginda.’” (H.R. Bukhari: 6327)

Manakala penzina *Ghair Muhsan* pula adalah penzina yang tidak mencukupi empat syarat ke atas penzina *Muhsan* iaitu baligh, berakal waras, merdeka dan pernah melakukan jimak dengan nikah yang sah. Selain itu, ia juga termasuk dari kategori seseorang yang sudah berkahwin akan tetapi belum dapat merasai nikmat persetubuhan melalui jalan pernikahan

(Fathi Yusof 2015). Hukuman bagi pezina jenis ini adalah disebat sebanyak 100 kali dan dibuang daerah selama satu tahun ke tempat yang jaraknya seperti jarak musafir atau lebih. Antara dalil yang menyokong adalah seperti firman Allah di dalam surah al-Nur, ayat 2 yang bermaksud:

“Perempuan yang berzina dan lelaki yang berzina yang bukan muhsan, hendaklah kamu sebat setiap seorang daripada mereka seratus kali sebatan. Janganlah kamu dipengaruhi oleh perasaan belas kasihan terhadap mereka dalam menjalankan hukum agama Allah, jika benar kamu beriman kepada Allah dan hari akhirat. Hendaklah hukuman seksa yang dikenakan kepada mereka itu disaksikan oleh sekumpulan daripada orang yang beriman.” (Q.S. Al-Nur: 24: 2)

Adapun dalil yang menjadi bukti hukuman buang daerah ke atas pezina *ghair Muhsan* pula adalah seperti hadis yang diriwayatkan oleh Imam al-Bukhari dan Imam Muslim di dalam kitab sahih mereka yang bermaksud:

“Nabi SAW bersabda: ‘Demi Allah, saya akan berhukum antara kamu berdua dengan Kitab Allah. Adapun hamba perempuan dan kambing tersebut dikembalikan semula kepada kamu. Anak lelakimu pula disebat sebanyak 100 kali sebatan dan dibuang daerah selama setahun. Adapun kamu wahai Unais (baginda bersabda kepada seorang lelaki): ‘Pergilah segera kepada isteri lelaki ini, maka rejamlah dia’. Lalu Unais segera pergi kepada perempuan itu dan merejamnya”. (H.R. Bukhari: 2498 & Muslim: 3210)

Daripada dalil-dalil yang telah penulis datangkan di atas, ia menjadi bukti betapa pentingnya Islam mengambil berat dalam hal ehwal keturunan. Oleh sebab itulah Allah SWT itu meletakkan hukuman yang begitu berat kepada hambanya yang ingkar agar mereka sentiasa berwaspada. Namun begitu, dalil-dalil di atas tidaklah hanya dikhususkan dalam skop zina sahaja. Bahkan para mujtahid juga telah memperluaskan maksudnya dengan menterjemahkannya dengan fahaman Maqasid Syariah. Maka dengan itu, bukanlah kesalahan zina sahaja yang diharamkan oleh syarak, bahkan semua perkara yang membawa kemudharatan kepada keturunan dan maruah turut diharamkan oleh syarak.

Ia seperti liwat, *Musahaqah* (hubungan perempuan sama perempuan), *Istimna* (Mengeluarkan air mani dengan tangan dan disengajakan), bercakap lucah, memberi isyarat lucah, berkhalwat antara lelaki dan perempuan yang bukan mahram, bergaul bebas antara lelaki dan perempuan yang bukan mahram, melihat benda-benda yang haram seperti aurat wanita, bersentuhan antara lelaki dan perempuan yang bukan mahram, berpelukan dan sebagainya. Walaupun ia tidaklah dikhususkan secara terperinci di dalam ayat yang telah penulis datang di atas, namun ia turut membawa kecurangan kepada prinsip asas Maqasid Syariah. Itulah yang disebut sebagai memahami sesuatu nas dengan saduran Maqasid Syariah.

Keindahan Islam dapat terbukti bukan sahaja dari kesalahan zina mampu mencemarkan maruah dan membawa kemudharatan pada orang lain, bahkan hukum syarak dalam Islam itu juga memperincikan perkara-perkara seangkatan yang mampu mendorong ke arah tersebut. Perkara itu adalah seperti *qadzaf*, iaitu menyatakan tuduhan yang tidak berasas kepada orang yang sempurna bernikah samaada lelaki atau perempuan atas kelakuan zina. Selain itu, kelakuan seperti mengandu domba, mengupat dan mencela juga merupakan kelakuan-kelakuan yang dapat disimpulkan dalam kelas yang membawa kepada kemudharatan dan meragut maruah segelintir masyarakat. (M.lutfi Khakim 2020).

Prinsip asas terakhir di dalam Maqasid Syariah itu pula adalah *Hifz al-Mal* iaitu Menjaga Harta. Di dalam Islam, syarak sangat berjaga-jaga dalam memelihara harta penganutnya. Ia bertujuan agar segala persengketaan yang membawa kepada pergaduhan dan pertelingkahan dapat dibendung sesama muslim. Seruan menjaga harta itu bukanlah hanya tertakluk kepada si Pemilik Harta sahaja, bahkan orang-orang sekitarnya juga diseru untuk menjaga harta antara satu sama lain. Sebab itulah jika kita merujuk kepada kebanyakan dalil daripada al-Quran dan al-Sunnah, Allah SWT dan Nabi SAW sering menyeru dan melarang umatnya untuk melakukan perkara-perkara yang boleh membawa kepada kerosakan harta. Tidak kiralah ia ditujukan kepada si pemilik harta mahupun harta orang lain.

Harta merupakan anugerah Allah SWT kepada hambanya. Setiap yang memiliki harta bertanggungjawab dalam menguruskannya bagi memiliki manfaat untuk dirinya sendiri dan masyarakat dengan melalui jalan syariat. Oleh itu, perkara ini merupakan amanah yang perlu dipikul dan dilaksanakan bagi mendapatkan keberkatan dan keredhaan Allah SWT. Sesungguhnya harta yang telah dimiliki atau yang telah dikurniakan kepada seseorang itu bukan untuk menunjukkan kekayaan pada mana-mana manusia. Secara tepatnya adalah, satu pengakuan bahawa harta yang dimiliki tersebut merupakan sabit kepada kekayaan mutlak Allah SWT. Maka tugas manusia hanya untuk memelihara, mentadbir atau mengurus demi kesejahteraan manusia sejagat (Yazid Ahmad 2006).

Atas kewaspadaan itulah syarak telah meletakkan hukum bagi orang yang merosakkan harta itu di dalam hukuman jenayah had ataupun hudud. Ia telah disokong sepertimana firman Allah dalam surah al-Ma'idah, ayat 33 yang bermaksud:

“Sesungguhnya balasan orang yang memerangi Allah dan Rasulnya serta melakukan kerosakan harta di muka bumi adalah dengan dibunuh kalau mereka membunuh sahaja tanpa merampas, atau disalib kalau mereka membunuh dan merampas, atau dipotong tangan dan kaki mereka secara bersilang kalau mereka merampas sahaja atau dibuang negeri kalau mereka hanya mengganggu ketenteraman umum. Hukuman itu adalah suatu kehinaan bagi mereka di dunia. Sementara di akhirat kelak, mereka beroleh azab yang dahsyat”. (Q.S. Al-Maidah: 5: 33)

Menurut sebahagian sarjana Islam, mereka berpandangan bahawa ayat ini adalah ditujukan kepada hukuman bagi orang yang melakukan jenayah merompak. Adapun bagi orang yang melakukan jenayah mencuri pula, hukuman ke atas mereka adalah merujuk kepada dalil seperti mana dalam firman Allah SWT di dalam surah al-Ma'idah, ayat 38 yang bermaksud:

“Pencuri lelaki dan pencuri perempuan, maka hendaklah kamu potong tangan mereka berdua sebagai balasan kepada mereka dengan sebab apa yang mereka telah kerjakan, dan sebagai suatu hukuman pencegah yang datang daripada Allah. Allah maha perkasa lagi maha bijaksana”. (Q.S. Al-Maidah: 5: 38)

Pun begitu, penulis berpandangan bahawa di sana tiada perbezaan di antara merompak mahupun mencuri. Ini adalah kerana hukuman ke atas keduanya adalah sama sahaja. Dan yang membezakan antara keduanya hanya pada sudut istilahnya dan konsepnya sahaja. Namun begitu, penulis sentiasa meraikan perbezaan pendapat tersebut selagi mana ia masih berada di bahawa satu prinsip yang sama iaitu *Hifz Al-Mal* iaitu menjaga harta di dalam Maqasid Syariah. Daripada dalil-dalil di atas, para mujtahid telah meluaskan fahaman mereka dalam mentafsir dan menterjemahkan maksudnya bukan sahaja dilihat pada zahir ayatnya sahaja. Bahkan bagi mereka, tidak kiralah apa jua perbuatan selain daripada mencuri dan merompak yang boleh membawa kepada kerosakan harta adalah turut dilarang dan dicerca di dalam Islam. Ia seperti

mensia-siakan harta, merosakkan harta, membinasakan harta, meletakkan harta di jalan yang memudharatkan, pembaziran dalam menggunakan harta dan seumpama dengannya. Setiap sumber dan asal punca pencarian harta dari kaedah dan cara yang dilarang oleh islam perlu dititik beratkan kerana perkara ini akan membawa kepada zat yang akan bercantum menjadi satu atau segumpal darah daging manusia tersebut (Zulkifli al-Bakri 2020).

KESIMPULAN

Daripada perincian prinsip-prinsip Maqasid Syariah yang telah dihuraikan penulis di atas, dapatlah penulis rumuskan bahawa pemahaman nas dengan menerapkan lima hal *al-Dharuriyyat al-Khams* dalam Maqasid Syariah iaiti *Hifz al-Din*, *Hifz al-Nafs*, *Hifz al-'Aql*, *Hifz al-Nasl* dan *Hifz al-Mal* merupakan teori utama dalam *Ijtihad Maqasidi*. Hal ehwal *al-Dharuriyyat al-Khams* ini sentiasa diambil kira oleh para mujtahid dan para mufti dalam mentafsir sesuatu ayat mahupun nas. Ia bertujuan agar setiap nas yang diterjemahkan itu sentiasa dapat dilihat dari dimensi yang berbeza demi menjaga kemaslahatan manusia sejagat dan menolak keburukan. Inilah metodologi menurut jumbuh sarjana usul dalam melakukan proses pengeluaran hukum. Ia mestilah menjadi suatu keperluan yang dimestikan demi mendapatkan dan mengeluarkan suatu hukum yang telus dan harmoni. Oleh yang demikian, pihak-pihak berautoriti perlulah sentiasa berhati-hati dalam memahami nas syarak agar pengeluaran fatwa yang dilakukan adalah lebih harmoni berkonsepkan *Ijtihad Maqasidi*.

BIBLIOGRAFI

- Abdullah, M.M. (2021). *Nikah Khitbah: An Alternative To Resolve The Illegitimate Child Births Issues*. Jurnal Fatwa, Universiti Sains Islam Malaysia (USIM).
- Al-Bakri, Z. (2017). *Bertaubat Daripada Mencuri Dengan Cara Bersedekah Kepada Fakir Miskin*. Bayan Linnas Siri ke-522, Pejabat Mufti Wilayah Persekutuan. Retrieved from: <https://muftiwp.gov.my/artikel/irsyad-fatwa/irsyad-fatwa-umum/4547-irsyad-al-fatwa-siri-ke-522-bertaubat-daripada-mencuri-dengan-cara-bersedekah-kepada-fakir-miskin>
- Al-Bakri, Z. (2017). *Hindari Bahaya Arak*. Bayan Linnas Siri ke-117, Pejabat Mufti Wilayah Persekutuan. Retrieved from: <https://muftiwp.gov.my/perkhidmatan/artikel-soal-jawab/659-bayan-linnas-siri-ke-116-hindari-bahaya-arak>
- Al-Bakri, Z. (2019). *Maqasid Syariah Dalam Perubatan*. Bayan Linnas Siri ke-189, Pejabat Mufti Wilayah Persekutuan. Retrieved from: <https://muftiwp.gov.my/perkhidmatan/artikel-soal-jawab/3541-bayan-linnas-siri-ke-189-maqasid-syariah-dalam-perubatan>
- Al-Khin, M. (2011). *Al-Fiqh al-Manhaji*. Dar al-Kalam, Beirut.
- Al-Qaradawi, Y. (2000) *Nazariyyat Maqasid Syari'ah bayn Ibn Taimiyyah wa Jamhur al-Usuliyin*. Universiti Kaherah.
- Al-Sayuti, J. (2002). *Al-Jami' As-Saghir Min Hadis Al-Basyir An-Nazir*. Dar al-Kutub al-Ilmiah, Beirut.
- Al-Syarbini. M. (2004). *Al-Iqna' Fi Halli Al-Fazhi Abi Syuja'*. Dar al-Kutub al-Ilmiyyah, Beirut.
- Awdah, J. (2006). *Inatoh Al-Ahkam Al-Syar'iyah bi Maqasidiha*. Al-Maahad Al-Alami Li Al-Fikr Al-Islami, Beirut.
- Azhar, A., Hussain, M.A., Md. Nor, M.Z. & Othman, M.K. (2017). *Penyelidikan Fatwa dalam Kerangka Maqasid al-Syariah: Satu Tinjauan*. Ulum Islamiyyah: Malaysian Journal of Islamic Sciences. Universiti Sains Islam Malaysia (USIM).

- Bahari, N. (2020). *Pemakaian Elemen Maqasid Syariah dalam Institusi Fatwa di Malaysia*. Persidangan Antarabangsa Sains Sosial dan Kemanusiaan (PASAK5 2020), Kolej Universiti Islam Selangor (KUIS).
- Creswell. (2009). *Qualitative Inquiry and Research Desing: Choosing among five approaches*. Thosand Oaks, CA, Sage.
- Creswell. (2009). *Qualitative Inquiry and Research Desing: Choosing among five approaches*. Thosand Oaks, CA, Sage.
- Ibnu Qayyim. (2007). *Bahaya Zina*. (Tim Darul Haq. Trans). Maktab Dakwah dan Bimbingan Jaliyat Rabwah, Jakarta.
- Kamaruddin, H. (2000). *Resiko Sebuah Pilihan, dalam Nurcholish Madjid (et al.),. Kehampaan Spritual Masyarakat Modern*. Cet. 1. Penerbit Mediacita, Jakarta.
- Khakim, M.L. & Ardiyanto, M. (2020). *Menjaga Kehormatan Sebagai Perlindungan Nasab Perspektif Maqasid Syariah*. Nizham: Jurnal Studi Keislaman. IAIN Metro.
- Mat Saad, H. (2021). *Maqasid Memelihara Akal (Hifz al-'Aql) dan hubungannya dengan Falsafah Pendidikan Kebangsaan*. Universiti Multimedia Melaka.
- Mat Saad, Hasbollah. & Rajamanickam, R. (2021). *Maqasid Memelihara Akal (Hifz al-'Aql) dan Hubungannya dengan Falsafah Pendidikan Kebangsaan*. Jurnal Islamiyyat 43 (Isu Khas). Universiti Multimedia Melaka.
- Miles, B.M. & Huberman, M.A. (1994). *Qualitative Data Analysis: An Expanded Source Book*. California: Sage.
- Mustaqim Roslan, M. 2012. *Masalah Mursalah 'inda Imam Izz al-Din wa Imam Asy-Syathibi*. Disertasi Sarjana, Fes Morocco
- Rosalina, Y.A. (2017). *Masuknya Paradigma Interpretif Pada Kajian Ilmu Akuntansi*. Jurnal Analisa Akuntansi dan Perpajakan, Vol. 1, No. 1. Universitas Brawijaya.
- Saat, R.A. (2019). *Maqasid Syariah dalam Urus Tadbir*. Proceeding of the International Conference on Islamic Civilization and Technology Management. Universiti Sultan Zainal Abidin (UniSZA).
- Yaacob, A.R., Ibrahim, R.A., Hadi Ishak, M.A. & Rashid, R. (2011). *Punca Stress Di Kalangan Pelajar Politeknik Tuanku Syed Sirajuddin*. Politeknik Tuanku Syed Sirajuddin.
- Yusof, M.F., Ghazali, M.I., Rosman, A.S. & Nizar, T.J. (2015). *Maqasid Syariah dalam Pelaksanaan Hukum Hudud ke Atas Pesalah Zina*. Universiti Teknologi Malaysia.

Pendefinisian Persediaan Rapi Tenaga Pengajar dalam Proses Pembelajaran dan Pengajaran di Institusi Pengajian Tinggi

Najjah Salwa Abd Razak
Universiti Pertahanan Nasional Malaysia
najjah@upnm.edu.my

Norashikin Sahol Hamid
Universiti Pertahanan Nasional Malaysia
norashikin.saholhamid@upnm.edu.my

Nur Syafiqah Mohd Yazib
Universiti Pertahanan Nasional Malaysia
nursyafiqah@upnm.edu.my

Norshima Zainal Shah
Universiti Pertahanan Nasional Malaysia
shima@upnm.edu.my

ABSTRAK

Sistem pendidikan di Malaysia menyelusuri pelbagai siri pembangunan bagi memastikan kualiti pendidikan dicapai selari dengan keperluan semasa. Pembangunan dalam pendidikan sangat bermanfaat untuk memberikan pendidikan terbaik kepada para pelajar. Justeru, bagi memastikan pembangunan insan dicapai, tenaga pengajar perlu mempunyai persediaan rapi dalam menyediakan suasana pembelajaran dan pengajaran yang membantu para pelajar mendapat pendidikan yang terbaik. Kajian ini bertujuan untuk mendefinisikan makna persediaan rapi tenaga pengajar dalam konteks menyediakan suasana pembelajaran dan pengajaran yang efektif dalam kalangan tenaga pengajar di Universiti Pertahanan Nasional Malaysia (UPNM). Seterusnya, kajian ini turut menganalisis usaha tenaga pengajar dalam memenuhi jangkaan para pelajar dalam proses pembelajaran dan pengajaran. Kajian pelbagai kes ini menggunakan kaedah temu bual mendalam separa berstruktur. Temu bual direkod dan kemudiannya ditranskripsikan secara verbatim. Analisis tematik digunakan daripada dapatan kajian yang mencapai data yang tepu. Hasil kajian menunjukkan terdapat peserta kajian dalam kalangan tenaga pengajar menunjukkan persediaan rapi yang tekal dan membantu dalam pendefinisian persediaan rapi selari dengan literatur manakala terdapat peserta kajian yang mengamalkan pengajaran secara fleksibel. Kajian ini memberi implikasi terhadap penyediaan garis panduan tenaga pengajar yang membantu tenaga pengajar dalam menyediakan suasana pembelajaran dan pengajaran bersesuaian dengan senario di UPNM khususnya dan dapat menjadi panduan kepada institusi pendidikan di Malaysia umumnya.

Kata kunci: *institusi pendidikan; pembelajaran dan pengajaran; persediaan, tenaga pengajar*

PENDAHULUAN

Pendidikan mempunyai peranan dan fungsi yang sangat sentral dalam membina sesebuah negara yang maju dan bertamadun. Tanpa pendidikan, kemajuan mungkin sukar untuk dicapai. Menerusi pendidikan, manusia mampu mencipta kreativiti yang tinggi dan menggalakkan perkembangan dalam bidang sosial, ekonomi, dan budaya. Malah dalam Islam jelas menegaskan bahawa pendidikan adalah sangat penting kepada manusia di mana darjat seseorang itu ditinggikan kerana ilmu pengetahuannya seperti mana yang disebut dalam Al-Quran: Surah Al-Mujadalah, ayat 11 (Khalsiah, Asma, & Marina, 2018).

Sistem pendidikan di Malaysia mempunyai siri demi siri pembangunan ke arah kecemerlangan kualiti pendidikan. Perkembangan pendidikan berguna untuk memberikan pendidikan terbaik kepada pelajar (Nooraini & Khairul Azmi, 2011) yang relevan dengan permintaan dan globalisasi semasa. Selari dengan perkembangan ini, tenaga pengajar mesti bersedia untuk memastikan pelajar memperoleh pengetahuan dan menjadi graduan yang kompeten yang mana Cheng, Adekola, Albia, dan Cai (2021) menghujahkan bahawa kebolehpasaran graduan adalah keutamaan bagi insitisi-insitisi pengajian tinggi. Dengan itu, kesediaan tenaga pengajar untuk memastikan mereka dapat memberikan pengalaman terbaik kepada pelajar dalam pengajaran dan pembelajaran berkesan adalah pendekatan penting yang mesti dikuasai untuk memaksimumkan pemerolehan pengetahuan dan kemahiran berkualiti dalam kalangan pelajar (Santos & Castro, 2021).

Kualiti dalam pendidikan adalah untuk mempelajari dan menguasai sesuatu ilmu dan kemahiran dengan baik. “Kualiti” adalah kata kunci dalam pengajian dan pendidikan tinggi di mana keutamaan setiap institusi adalah untuk melahirkan graduan berkualiti. Namun, usaha meningkatkan kualiti sistem pendidikan adalah antara cabaran utama insitisi pengajian tinggi (Nagoba & Mantri, 2015). Pelbagai kajian telah menunjukkan bahawa terdapat hubungan korelasi yang positif atau signifikan antara kelayakan dan kebolehan tenaga pengajar dalam pengajaran dan prestasi akademik pelajar. Ezeh (2020) menekankan bahawa tenaga pengajar yang tidak mempunyai kompetensi untuk menyampaikan pengajaran yang berkualiti akan memberi kesan terhadap pencapaian dan kemahiran pelajar.

Seterusnya, berdasarkan matlamat pembangunan mampan *Sustainable Development Goals* (SDG), salah satu inisiatif kerajaan-kerajaan seluruh dunia ialah menumpukan perhatian dan prihatin dalam menggalakkan pertumbuhan yang mampan dalam negara adalah dari segi kesejahteraan rakyat, pertumbuhan ekonomi, perundangan alam sekitar dan kemajuan sektor pendidikan. Salah satu matlamat SDG 4 yang menekankan keutamaan pendidikan kepada semua iaitu dengan slogan “*ensure inclusive and equitable quality education and promote lifelong learning opportunities for all*” (UNESCO, 2022) termasuklah mendidik pelajar dengan memberikan pendidikan berkualiti tinggi (Saini, Sengupta, Singh, Singh, & Singh, 2022). Oleh yang demikian, untuk mencapai matlamat ini beberapa kekangan asas perlu diselesaikan terlebih dahulu antaranya termasuklah merapatkan ketidaksamaan dan jurang yang semakin meningkat dalam suasana dan peluang pembelajaran di antara pelajar yang mempunyai sosioekonomi yang berbeza (Gupta & Sampat, 2021).

Kerugian bentuk ekonomi akan lebih dirasai oleh pelajar yang kurang berkemampuan berbanding dengan pelajar yang berkemampuan untuk belajar dengan kemudahan-kemudahan yang boleh membantu pembelajaran efektif. Senario ini dapat dilihat dengan lebih ketara ketika pandemik COVID-19 di mana pelajar yang datang dari keluarga yang kurang berkemampuan tidak dapat meneruskan pembelajaran di rumah kerana kekangan pemerolehan internet untuk kelas dalam talian. Oleh sebab ini, pelajar-pelajar ini akan ketinggalan berbanding dengan pelajar lain yang lebih bernasib baik (Hanushek & Woessmann, 2020). Rahmat (2020) turut menegaskan bahawa pendidikan adalah penting untuk pertumbuhan dan perkembangan masyarakat di mana ia adalah instrumen perubahan yang boleh mengubah individu dalam komuniti dan kemudiannya mengubah masyarakat secara menyeluruh.

Terdapat kajian yang mendapati bahawa kemudahan yang ada di institusi pengajian boleh memberi impak yang mendalam terhadap kedua-dua hasil tenaga pengajar dan pelajar. Kemudahan dan fasiliti yang sedia ada di institusi pengajian mempengaruhi pengambilan tenaga pengajar, pengekalan ataupun *turnover* di tempat kerja, komitmen dan usaha tenaga

pengajar. Berkenaan dengan pelajar pula, kemudahan di institusi pengajian boleh mempengaruhi kesihatan, tingkah laku, keterlibatan pelajar atau *engagement* dalam pembelajaran dan pencapaian akademik mereka. Oleh itu, para penyelidik secara amnya menyimpulkan bahawa tanpa kemudahan dan sumber yang mencukupi di institusi pengajian, ia akan menjadi amat sukar untuk memberi perkhidmatan pengajaran dan pembelajaran yang baik (Pennsylvania State University, 2015).

Peranan tenaga pengajar dalam memberikan yang terbaik sepanjang proses pembelajaran dan pengajaran sangat memberi impak terhadap keberkesanan kaedah pengajaran yang dilaksanakan. Kajian lain yang turut melihat perkara ini mempunyai hubungan yang signifikan antaranya ialah kajian Kim, Raza dan Seidman (2019). Kajian mereka secara terperinci mendapati bahawa terdapat hubungan signifikan antara kualiti pengajaran dan pembelajaran pelajar dalam sesi kuliah dan hubungannya dengan hasil pembelajaran. Kajian tersebut turut menunjukkan bahawa kemahiran yang diperlukan untuk pengajaran dan pembelajaran yang berkualiti melibatkan kecekapan dan kemahiran penting yang melangkaui kebolehan literasi dan numerasi di mana ia dikenali sebagai kemahiran abad ke-21. Antara kecekapan yang diperlukan termasuklah kebolehan dalam pemikiran kritis, kesediaan memberi solusi bernas kepada penyelesaian masalah, kreativiti, metakognisi, komunikasi, literasi dalam digital dan teknologi, tanggungjawab sivik dan kesedaran global.

Justeru, kompetensi dalam kalangan tenaga pengajar juga amat mustahak dalam melahirkan graduan serba boleh untuk memenuhi keperluan majikan masa kini. Hamid, Islam, dan Hazilah (2014) menegaskan bahawa sekiranya bilangan graduan yang semakin meningkat tidak mempunyai kemahiran dan kompetensi sejajar dengan bilangan pekerjaan yang diwujudkan, ia boleh menyumbang kepada masalah pengangguran yang serius dalam negara. Perkara yang dibahaskan mereka sebenarnya masih dibincangkan sehingga kini memandakan isu ini masih relevan dan semakin diperlukan dengan adanya peralihan zaman yang mementingkan kepelbagaian dalam memastikan kelangsungan kompetensi pelajar. Lebih-lebih lagi, tenaga pengajar merupakan pendidik yang mempunyai akauntabiliti penting dalam menyediakan dan mendidik generasi muda untuk memainkan peranan tertentu dalam masyarakat pada masa akan datang (Ab. Halim Tamuri & Mohamad Khairul Azman, 2010). Oleh itu, terdapat dua objektif kajian ini iaitu bertujuan untuk mendefinisikan makna persediaan rapi tenaga pengajar dalam konteks menyediakan suasana pembelajaran dan pengajaran yang efektif dalam kalangan tenaga pengajar di Institusi Pengajian Tinggi (IPT) dengan memfokuskan kepada Universiti Pertahanan Nasional Malaysia (UPNM). Seterusnya, kajian ini turut menganalisis usaha tenaga pengajar dalam memenuhi jangkaan para pelajar dalam proses pembelajaran dan pengajaran.

PERSEDIAAN TENAGA PENGAJAR DALAM PROSES PEMBELAJARAN DAN PENGAJARAN

Tenaga pengajar perlu mempunyai tanggungjawab tersendiri untuk memastikan keberkesanan pengajarannya. Mereka perlu membuat persediaan terbaik yang mempertimbangkan pelbagai dimensi yang mencapai hasil pembelajaran. Sebagai contoh, seseorang tenaga pengajar mesti mempunyai pemahaman yang baik tentang makna kandungan subjek. Tambahan pula, terdapat banyak faktor yang mempengaruhi pembelajaran efektif dalam kalangan pelajar yang memerlukan kemampuan tenaga pengajar yang kompeten dalam merealisasikan kejayaan sesuatu proses pembelajaran dan pengajaran. Green, Eady, dan Andersen (2018) menegaskan bahawa tenaga pengajar yang berkualiti adalah antara elemen terpenting yang mempengaruhi kejayaan pelajar.

Coe et al., (2014) menekankan bahawa, "tenaga pengajar yang paling berkesan mempunyai pengetahuan yang mendalam berkenaan subjek yang mereka ajar, dan apabila pengetahuan mereka jatuh di bawah tahap tertentu, situasi tersebut menjadi halangan penting kepada proses pembelajaran pelajar. Selain pemahaman yang kuat tentang bahan yang diajar, tenaga pengajar juga harus memahami cara pelajar berfikir tentang kandungan, dapat menilai pemikiran di sebalik kaedah pelajar sendiri, dan mengenal pasti salah tanggapan umum pelajar".

Selain itu, tenaga pengajar bukan sahaja perlu mempunyai kelayakan dan ilmu pengetahuan yang mencukupi untuk memenuhi kehendak tugas mereka sebagai pendidik bahkan perlu mempunyai kemahiran komunikasi. Fasih berkomunikasi secara berkesan dengan pelajar tentang topik-topik pengajaran yang hendak disampaikan perlu menjadi antara keutamaan. Secara tidak langsung, ia membantu dalam membentuk graduan yang mahir dalam bidang yang dipelajari. Ia juga penting untuk tenaga pengajar merancang aktiviti pengajaran dan pembelajaran kelas untuk memastikan setiap sesi pengajaran itu kondusif dan efektif. Tenaga pengajar yang dikatakan superior atau hebat ialah seseorang yang mampu bersyarah dengan jelas dan mudah difahami, merupakan pakar dalam subjek atau kursus yang dikendali, membuat persiapan rapi untuk pengajaran dan pembelajaran efektif, dan mempunyai hubungan baik dengan pelajar. Personaliti dan pendekatan tenaga pengajar dengan pelajar juga memainkan peranan dalam memenuhi sesi pengajaran dan pembelajaran berkesan (Orakci, 2020).

Justeru, berpengetahuan mengenai pendekatan pengajaran yang sesuai adalah salah satu dimensi penting bagi seseorang tenaga pengajar sama ada pensyarah atau guru di pelbagai institusi pendidikan termasuk peringkat prasekolah kerana ia saling berkaitan dengan keberkesanan tenaga pengajar.

Hari demi hari memperlihatkan bahawa tenaga pengajar perlu mempunyai kekuatan, keinginan dan usaha dalam menjayakan pendekatan pengajaran mereka. Perkembangan sebaran informasi yang pesat rentetan teknologi yang sentiasa berkembang memberi kesan terhadap tenaga pengajar. Tenaga pengajar kini dibebani dengan cabaran untuk membantu pelajar memahami dan menghadamkan sejumlah maklumat yang begitu banyak dalam waktu yang singkat. Selain itu tenaga pengajar juga harus mengenal pasti ketepatan maklumat dan sama ada sumber diperoleh itu datang dari sumber sah dan boleh dipercayai di samping menghubungkan pengetahuan baharu dengan pengetahuan terdahulu untuk faedah pelajar. Maklumat dan ilmu kini boleh diperoleh dalam pelbagai bentuk seperti teks, grafik, video dan audio. Oleh itu, tenaga pengajar mestilah mempunyai penguasaan dalam penggunaan teknologi terkini untuk mendidik pelajar melalui kaedah yang dapat memberi manfaat kepada mereka untuk mengelakkan daripada ketinggalan zaman (Ordu, 2021).

Jika matlamat pendidikan adalah kejayaan pelajar, maka, pemberian pengajaran berkualiti oleh tenaga pengajar adalah metode yang boleh memberi sumbangan dalam mencapai cita-cita tersebut. Hujah ini disokong oleh bukti daripada kajian yang menyelidik markah pencapaian dan penilaian tenaga pengajar dalam melahirkan anak didik yang berjaya. Para penggubal dasar pendidikan melihatkan sistem pendidikan berkesan banyak bergantung kepada kompetensi tenaga pengajar dalam memberikan pengalaman pembelajaran berimpak kepada pelajar. Justeru, penting wujudnya usaha untuk memastikan pengalaman pengajaran dan pembelajaran itu sentiasa berada di tahap yang memuaskan menerusi pelaburan yang berterusan dalam sektor pendidikan di samping sokongan padu tenaga pengajar (University of Texas Arlington, 2020).

Jelas sekali bahawa menjadi 'tenaga pengajar cemerlang' bermakna keberkesanan bukan sahaja berlaku di dalam bilik kuliah semata-mata (Mortiboys, 2010). Pelaksanaan pelbagai pendekatan pengajaran oleh tenaga pengajar bagi mencapai hasil pembelajaran juga menggambarkan tenaga pengajar yang bersedia. Ia membawa kepada proses pengajaran yang sangat baik. Mortiboys (2010) menyenaraikan persediaan pengajaran yang sangat baik yang berkait rapat dengan perkara berikut:

- a) Bersedia, positif, dan tabah, atau
- b) Bersemangat, memperkasakan dan tegas, atau bahkan
- c) Responsif, berdaya tahan dan bijak.

Tenaga pengajar dalam pertemuan bersemuka atau tidak bersemuka dengan pelajar, perlu mempunyai set kemahiran, pengetahuan, dan kualiti yang diperlukan, serta mempunyai kemampuan untuk mempersembahkannya atau mengajarnya dengan cara yang berkesan, selain memastikan penyertaan atau penglibatan pelajar. Coe et al., (2014) mentakrifkan pengajaran yang berkesan berlaku apabila terdapat peningkatan pencapaian pelajar dan memberi hasil yang penting untuk kejayaan masa depan mereka.

TANGGUNGJAWAB TENAGA PENGAJAR DALAM PENGURUSAN KELAS DAN PERSEDIAAN BERKUALITI KE ARAH MEMENUHI HARAPAN ATAU JANGKAAN PELAJAR

Tenaga pengajar mempunyai tanggungjawab dalam pengurusan kelas dan persediaan dalam melahirkan graduan yang kompeten. Korpershoek et al., (2014) menyatakan bahawa pengurusan bilik kuliah adalah interaksi berterusan antara tenaga pengajar dan pelajar mereka. Pengurusan bilik kuliah adalah berkait dengan aspek mewujudkan, mengundang dan menjadikan persekitaran yang menarik untuk pembelajaran pelajar (Korpershoek et al., 2014) manakala penyediaan bilik kuliah merujuk kepada persediaan pensyarah sebelum proses pengajaran dan pembelajaran (Abdull Sukor, 2008) serta berpengetahuan mengenai latar belakang pelajar dan kepelbagaian mereka (Abdull Sukor, 2018; Salleh Amat, n.d).

Spratt., Humphreys, G. dan Chan, V. (2002) seterusnya menegaskan bahawa pengiktirafan terhadap kepelbagaian gaya pembelajaran dan pilihan pelajar untuk kaedah pembelajaran akan memberi impak kepada tenaga pengajar terhadap kepelbagaian aktiviti yang perlu dipilih. Oleh itu, perancangan menyeluruh diperlukan untuk setiap subjek, tetapi rancangan tersebut perlu disesuaikan secara fleksibel berdasarkan maklum balas yang diperoleh di dalam kelas (Mortiboys, 2010). Mortiboys (2010) menyebut beberapa kemahiran yang diperlukan untuk menyediakan pembentangan yang berkesan dan memastikan penyertaan atau penglibatan pelajar seperti berikut:

- a) Mengatur kandungan yang sesuai
- b) Kejelasan dalam penghantaran
- c) Pengetahuan subjek
- d) Bahan untuk menunjukkan kepada pelajar
- e) Kepelbagaian dalam visual
- f) Menerangkan kemahiran
- g) Menjaga masa
- h) Bersemangat
- i) Mengadakan aktiviti yang bersesuaian
- j) Kejelasan dalam memberi arahan
- k) Pengetahuan tentang bagaimana cara individu belajar (dan pengetahuan tentang subjek)
- l) Bahan untuk kegunaan pelajar

- m) Kepelebagaian dalam aktiviti
- n) Kemahiran mendengar
- o) Keyakinan untuk bercakap dengan orang ramai
- p) Kaedah penyediaan

Jelas bahawa tanggungjawab tenaga pengajar ialah menerapkan pendekatan yang relevan dalam proses pembelajaran dan pengajaran yang sesuai dengan keperluan pelajar serta memastikan hasil pembelajaran yang difokuskan dapat dicapai. Coe et al., (2014), mendapati bahawa kualiti pengajaran memberikan bukti kukuh bahawa pelajar mendapat kesan yang baik daripada hasil pembelajaran dan pengajaran iaitu antaranya diperlihatkan dalam sesi soal jawab berkesan dan penggunaan penilaian oleh guru. Amalan khusus, seperti mengkaji semula pembelajaran terdahulu, menyediakan respons, model untuk pelajar, memberikan masa yang mencukupi untuk tugas dapat menyematkan kemahiran dengan cara yang betul dan progresif, memperkenalkan kaedah pembelajaran baharu juga merupakan elemen pengajaran berkualiti tinggi.

Pengajaran berkualiti dapat menyediakan graduan yang berkualiti. Er, Nadarajah, Ng, & Wong, (2020) menyelidik tentang jaminan kualiti dalam pendidikan dan persepsi pelajar ijazah sarjana muda dalam profesion kesihatan di sebuah universiti di Malaysia mendapati bahawa kualiti dalam persediaan tenaga pengajar dalam pengajaran akan memberi kesan kepada graduan dalam kesediaan mereka untuk bekerja, kebolehpasaran dan kualiti graduan sebagai tenaga profesional dalam bidang kesihatan. Tadbir urus akademik, struktur kurikulum, kandungan dan penyampaian, kualiti pengurusan fakulti dan pelajar, kemudahan pengajaran dan sumber pembelajaran adalah antara ciri-ciri penting dalam menyediakan pengalaman pengajaran dan pembelajaran yang cemerlang.

METODOLOGI KAJIAN

Kajian kes ini menggunakan kaedah temu bual mendalam separa berstruktur. Temu bual direkod dan kemudiannya ditranskripsikan secara verbatim. Analisis tematik digunakan daripada dapatan kajian yang diperolehi. Peserta kajian terdiri daripada pelbagai bidang pengajaran iaitu Matematik, Fizik, Pengajian Islam dan bidang bahasa. Tujuh peserta kajian dalam kalangan tenaga pengajar pensyarah telah ditemu bual. Mereka berpengalaman dalam bidang pendidikan antara sembilan hingga 20 tahun. Peserta kajian pertama dinamakan sebagai P1, P2 ialah peserta kajian kedua, P3 ialah peserta ketiga, P4 ialah peserta keempat. Seterusnya P5 ialah peserta kelima, P6 ialah peserta keenam dan P7 ialah peserta ketujuh kajian ini.

DAPATAN KAJIAN DAN PERBINCANGAN

Berikut ialah antara dapatan kajian ini yang memfokuskan kepada definisi kesediaan tenaga pengajar dari perspektif pengajaran mereka termasuk usaha yang tenaga pengajar laksanakan dalam memenuhi harapan atau jangkaan pelajar dalam proses pembelajaran dan pengajaran.

Untuk tujuan makalah ini, hanya beberapa tema sahaja dikemukakan yang berkait rapat dengan tajuk kajian ini. Antaranya, P6 melihat bahawa persediaan dalam pengajaran melibatkan pelbagai aspek seperti **menyediakan material seperti silabus, slide** dalam kelas serta **persediaan untuk menjawab soalan pelajar**. P6 menjelaskan: *“First thing is we align with syllabus, courses we are teaching,...look at the topic, we have to prepare in details, lessons and secondary is the slides, students should be provided with slides, notes, now the system is much easier and just transfer into files and they arrange and they read from notes*

and files, previously what we do is print it out and we distribute and some they keep it, you should be prepared to answer any question pertaining to the topic”.

P6 mempunyai pandangan yang sama berkenaan definisi kesediaan tenaga pengajar yang mana beliau menyatakan: *“Apa yang saya faham dengan pensyarah yang bersedia untuk mengajar ialah dari segi pertamanya mestilah ilmu pengetahuan untuk subjek yang akan diajar kemudian persediaan bantuan lain seperti slide utk dipersembahkan kepada pelajar dan mungkin bahan-bahan lain lah rujukan rujukan lain.”* P1 turut menekankan elemen yang penting iaitu **menyediakan aktiviti bersesuaian sebelum kelas dilaksanakan** *“Ok, based on my experience in teaching in the tertiary level ya, for more than 10 years, well-prepared instructor or preparedness lah, when the instructor has a lesson plan, has the activities and actually has plan the activities beford hand, before going to the class”.*

Seterusnya, P3 dan P1 mengakui bahawa antara aspek yang menunjukkan bahawa **keberkesanan pengajaran** pada setiap sesi pengajaran antaranya melalui **maklum balas yang diberikan pelajar**. P3 menyatakan: *“Pada perspektif kita nak tahu berkesan ke tak kita tgk macam mana student jawab soalan-soalan mcm kuiz, assignment, performance dia sampai hujung semester, after classlah selalunya after class tu sendiri pun ada student akan bertanya and then daripada situ kita tahu student faham atau tidak..daripada respon soalan-soalan kuiz kan daripada chapter-chapter tu”.*

Suasana yang kondusif dan persediaan pengajar dalam menyediakan *slide* antara aspek yang ditekankan P4. Beliau menyebut: *“Bagi saya, environment pembelajaran yang perlu disediakan oleh pensyarah supaya pelajaran itu sampai kepada pelajar antaranya ialah, persekitarannya mestilah kondusi dan juga selesa utk pelajar menerima pelajaran seperti mana mcm slide tdi pun adalah satu yang perlu disediakan oleh pensyarah. Slide tu bukanlah hanya sekadar panjang-panjang dia punya perkataan dalam tu tapi sampai apa yang kita nak ajarkan dan juga cara. Kemudian keduanya adalah cara pensyarah tu sendiri menyampaikan pengajaran tersebut”.* Apa yang ditekankan oleh P4 berkenaan suasana kondusif adalah merangkumi kepada aspek penyediaan material sebagaimana P6 dan pada masa yang sama P4 meletakkan elemen komunikasi sebagai suasana yang kondusif. Elemen komunikasi ini turut dinyatakan oleh P3.

P3 menjelaskan bahawa **elemen komunikasi** antara tenaga pengajar dan pelajar ialah elemen penting dalam memastikan jangkaan pelajar terhadap proses pembelajaran dan pengajaran. Beliau berkata: *“Satu lagi saya suka communicate dengan student. Bila student ask question, whatsapp kan, saya takdalah ignore saya akan layan, saya tanya macam mana soalan kuiz, ok tak tapi tak semua, cuma sapa yg rajin msg saya akan ok, takdalah yes no yes no ja, saya akan bagi jawapan, borak lagi dengan diorang tanya ada buat lagi tak group discussion ke, you all kena study hmm mcm tu lah kita bagi motivasi, takdalah pasal silibus je kan, jadi out of this”.*

Seterusnya, P1 pula menegaskan bahawa bagi memenuhi jangkaan pelajar, **tenaga pengajar perlu yakin dan tahu apa yang perlu diketengahkan** dalam sesi pembelajaran dan **pengajaran dan menepati objektif**: *“So before we go for the class, we are already know what we are going to teach them, we already have the activities which match the learning objectives of the day”.* Seterusnya P5 mendapati bahawa kaedah yang digunakan bagi memenuhi jangkaan pelajar ialah dengan **cara menghargai melalui kata pujian**. *“Dari segi tu bagaimana nak menarik perhatian pelajar, lah. Bagi yang menjawab, Alhamdulillah kita cakap baguslah kepada pelajar, kita appreciate, diorang kan”.*

P1 turut menyediakan dirinya untuk **mengajar dalam pelbagai suasana secara fleksibel** dengan melihat kepada keperluan sama ada secara bersemuka atau bukan secara bersemuka dengan menyediakan contoh yang bersesuaian. Beliau berkata: “...sebab tu, sometimes fizik ni dia ada subtopic yang students susah nak nampak, jadi, kitalah kena ambil contoh, kadang-kadang terpaksa guna apa sahaja yang ada, macam online (ketika sesi online). Kalau face to face dia agak mudah kan sebab dia direct kan, kalau online ni kita nak bg dia nampak 3D tu susah so kita terpaksa tunjuk dan pusing, kita kena suruh dia banyak imiginasi sebab kadang-kadang gambar tu kita akan bagi two dimensions, kan.

Berdasarkan kajian ini, tenaga pengajar di UPNM mempunyai pendekatan yang pelbagai dan bersifat fleksibel serta inovatif kerana tenaga akademik mengajar dalam persekitaran yang berbeza dari universiti lain kerana pelajar terdiri daripada kadet dan pelajar awam. Mereka mempunyai gaya pembelajaran yang berbeza, peruntukan masa pembelajaran, dan pengalaman pembelajaran. Kepelbagaian gaya pembelajaran perlu diambil kira oleh tenaga pengajar dalam memastikan persediaan pengajaran mereka bersifat efektif (Mortiboys, 2010).

Selain itu, tenaga pengajar dalam kajian ini mengakui bahawa suasana pembelajaran dan pengajaran turut memainkan peranan penting bagi pengajaran yang berkualiti (Korpershoek et al., 2014) yang ditonjolkan melalui kemampuan tenaga pengajar untuk terus fokus begitu juga kemampuan pelajar untuk kekal memberi komitmen dan fokus yang baik kepada tenaga pengajar, serta suasana yang kondusif.

Semua tenaga pengajar dalam kajian ini memperlihatkan bahawa mereka mengakui peranan tenaga pengajar dalam menyediakan pengajaran yang efektif kerana berkait rapat dengan mendapatkan hasil pembelajaran yang sepatutnya dan yang dipertanggungjawabkan. Bahkan, kajian Kim, Raza dan Seidman (2019) turut menonjolkan hubungan signifikan antara pengajaran dan hasil pembelajaran.

Perkara paling utama yang ditekankan oleh tenaga pengajar dalam kajian ini ialah tenaga pengajar perlu mempunyai pengetahuan berkenaan sesuatu subjek yang diajar yang menunjukkan bahawa ia sebagai sebahagian daripada persediaan rapi tenaga pengajar itu sendiri. Selain itu, aspek motivasi turut diterapkan tenaga pengajar dalam memastikan pelajar rasa dihargai melalui pujian apabila pelajar dapat menjawab persoalan yang diberikan tenaga pengajar. Aspek motivasi yang diterapkan oleh tenaga pengajar dalam pengajaran dapat dikaitkan dengan personaliti tenaga pengajar yang melihat bahawa nilai keinsanan melalui pengajaran dapat meningkatkan semangat dan kemajuan pelajar dalam pengajian mereka. Secara tidak langsung, pendekatan tersebut menjadi nilai tambah kepada kualiti seseorang tenaga pengajar. Green, Eady, dan Andersen (2018) mendukung aspek tenaga pengajar berkualiti sebagai faktor kejayaan seseorang pelajar.

Kajian ini menunjukkan komunikasi menjadi antara aspek penting dalam pendefinisian persediaan rapi tenaga pengajar. Aspek ini telah diperlihatkan oleh Orakcı, (2020) yang meletakkan komunikasi sebagai suasana kondusif buat pelajar sepanjang sesi pengajaran kerana melalui komunikasi yang jelas, pelajar mampu memahami apa yang diketengahkan oleh tenaga pengajar tentang sesuatu maklumat yang disampaikan.

Kajian skala kecil ini menggunakan kaedah temu bual dan terhad kepada peserta dari dua pusat sahaja sekalipun berbeza latar belakang. Kajian selanjutnya disarankan supaya melibatkan pelbagai latar belakang fakulti atau dari fakulti yang sama dengan skop yang

berbeza. Selain itu, kaedah kajian dapat diperkembangkan kepada kaedah soal selidik untuk mendapatkan persepsi secara menyeluruh dari institusi yang sama dan institusi luar.

KESIMPULAN

Berdasarkan kajian ini, tenaga pengajar perlu mempunyai tanggungjawab penting bukan sahaja untuk dirinya sendiri, tetapi terhadap pelajar, institusi dan masyarakat secara keseluruhan. Seseorang pensyarah umpamanya perlu mengambil kira isu-isu penting ini; pengurusan dan penyediaan kelas kerana kedua-duanya melambangkan makna pensyarah yang bersedia yang memenuhi harapan pelajar. Hasil kajian menunjukkan terdapat peserta kajian dalam kalangan tenaga pengajar menunjukkan persediaan rapi yang konsisten dan membantu dalam pendefinisian persediaan rapi selari dengan literatur manakala terdapat peserta kajian yang mengamalkan pengajaran secara fleksibel. Kajian ini memberi implikasi terhadap penyediaan garis panduan tenaga pengajar yang membantu tenaga pengajar dalam menyediakan suasana pengajaran dan pembelajaran yang bersesuaian dengan senario di UPNM khususnya dan dapat menjadi panduan kepada institusi pendidikan di Malaysia umumnya.

RUJUKAN

- Ab. Halim Tamuri & Mohamad Khairul Azman Ajuhary. 2010. Amalan Pengajaran Guru Pendidikan Islam Berkesan Berteraskan Konsep Mu ' allim. *Journal of Islmaic and Arabic Education*, 2(1).
- Abdull Sukor Shaari. 2008. *Guru Berkesan Petua dan Panduan*. Sintok, Kedah: Penerbit Universiti Utara Malaysia.
- Ali, R. 2010. Effectiveness of Modular Teaching in Biology at Secondary Level. *Asian Social Science*, 6(9), 49–54.
- Best, K., Jones-Katz, L., Smolarek, B., Stolzenburg, M. & Williamson, D. 2014. Listening to Our Students: An Exploratory Practice Study of ESL Writing Students' Views of Feedback. *TESOL Journal*, (June), n/a–n/a. doi:10.1002/tesj.152
- Cheng, M., Adekola, O., Albia, J., & Cai, S. (2021). Employability in higher education: a review of key stakeholders' perspectives. *Higher Education Evaluation and Development*, 16(1), 16-31. doi:https://doi.org/10.1108/HEED-03-2021-0025
- Coe, R., Aloisi, C., Higgins, S. & Major, L. E. 2014. *What makes great teaching? Review of the underpinning research*. Retrieved from <http://www.suttontrust.com/researcharchive/great-teaching/>
- Er, H. M., Nadarajah, V. D., Ng, S. H., & Wong, A. N. (21 July , 2020). Quality assurance in education: perception of undergraduate health professions students in a Malaysian university. *Korean Medical Journal of Education*, 32(3), 185–195. doi:10.3946/kjme.2020.166
- Ezeh, J. (2 October, 2020). Effects of Unqualified Teachers on Student's Academic Performance. [Linkedin.com](https://www.linkedin.com/pulse/effects-unqualified-teachers-students-academic-performance-jane-ezeh-1f/). Retrieved from <https://www.linkedin.com/pulse/effects-unqualified-teachers-students-academic-performance-jane-ezeh-1f/>
- Green, C., Eady, M., & Andersen, P. (2018). Preparing quality teachers: Bridging the gap between tertiary experiences and classroom realities. *Teaching and Learning Inquiry*, 6(1). doi:https://doi.org/10.20343/teachlearning.6.1.10
- Gupta, N., & Sampat, S. (29 July, 2021). How teacher expectations empower student learning. *BROOKINGS*. Retrieved from <https://www.brookings.edu/blog/education-plus-development/2021/07/29/how-teacher-expectations-empower-student-learning/>
- Hamid, M. S., Islam, R., & Hazilah, A. M. (2014). Malaysian graduates' employability skills enhancement: an application of the importance performance analysis. *J. Global*

- Business Advancement, 7(3), 181-197.
- Hanushek, E. A., & Woessmann, L. (2020). The Economic Impacts of Learning Losses. OECD. Retrieved from <https://www.oecd.org/education/The-economic-impacts-of-coronavirus-covid-19-learning-losses.pdf>
- Huang, L.-S. 2010. Seeing eye to eye? The academic writing needs of graduate and undergraduate students from students' and instructors' perspectives. *Language Teaching Research*, 14(4), 517–539. doi:10.1177/1362168810375372
- Khalsiah, Asma, N., & Marina. (2018). The Efforts of Improving the Professionalism of Lecturers towards the Presentation and Change of KKNi within the University Environment in Aceh. Proceedings of MICoMS 2017 (Emerald Reach Proceedings Series, Vol. 1) (pp. 19-25). Emerald Publishing Limited, Bingley. doi: <https://doi.org/10.1108/978-1-78756-793-1-00066>
- Kim, S., Raza, M., & Seidman, E. (2019). Improving 21st-century teaching skills: The key to effective 21st-century learners. *Research in Comparative and International Education*, 14(1), 99-117. doi:<https://doi.org/10.1177/17454999198292>
- Korpershoek, H., Harms, T., De Boer, H., Van Kuijk, M. & Doolaard, S. 2014. *Effective classroom management strategies and classroom management programs for educational practice*. GION, hlm. Vol. 501.
- Mortiboys, A. 2010. *How to be an Effective Teacher in Higher Education*. England: Mc Graw Hill Open University Press.
- Nagoba, B., & Mantri, S. B. (Jan-March , 2015). Role of Teachers in Quality Enhancement in Higher Education. *Journal of Krishna Institute of Medical Sciences University*, 4(1), 177-182.
- Neill, G. O. & McMahon, T. 2005. Student-centred learning: What does it mean for students and lecturers? *Emerging Issues in the Practice of University Learning and Teaching*.. Dublin: AISHE.
- Nooraini Othman & KhairulAzmi Mohamad. 2011. Eclectic Model in the Malaysian Education System. *International Education Studies*, 4 (4).
- Orakçı, Ş. (25 January, 2020). Postgraduate Students' Expectations of Their Lecturers. The Qualitative Report, 25(1), 199-215. doi:<https://doi.org/10.46743/2160-3715/2020.4010>
- Ordu, U. B.-A. (2021). The Role of Teaching and Learning Aids/Methods in a Changing World. In *New Challenges to Education: Lessons from Around the World* (Vol. 19, pp. 210-216). Sofia: Bulgarian Comparative Education Society.
- Pennsylvania State University. (7 June, 2015). The Importance of School Facilities in Improving Student Outcomes. PennState. Retrieved from <https://sites.psu.edu/ceepa/2015/06/07/the-importance-of-school-facilities-in-improving-student-outcomes/>
- Rahmat, N. H. (2020). Revisiting Lecturer's Role: Towards a Model of Lecturers' Quadrants. *European Journal of Education Studies*, 165-178. doi:10.46827/ejes.v8i6.3790
- Sadiq, S. & Dr Shazia Zamir. 2014. Effectiveness of Modular Approach in Teaching at University Level. *Journal of Education and Practice*, 5(17), 103–110.
- Saini, M., Sengupta, E., Singh, M., Singh, H., & Singh, J. (2022). Sustainable Development Goal for Quality Education (SDG 4): A study on SDG 4 to extract the pattern of association among the indicators of SDG 4 employing a genetic algorithm. *Education and Information Technologies*. doi:<https://doi.org/10.1007/s10639-022-11265-4>
- Salleh Amat. (n.d.). Motivasi dalam Pengajaran dan Pembelajaran. Dlm. Mohamed Amin Embi (pnyt.). *Panduan Amalan Pengajaran dan Pembelajaran Berkesan*.. Bangi: Pusat Pembangunan Akademik UKM.
- Santos, J. M., & Castro, R. D. (2021). Technological Pedagogical content knowledge (TPACK) in action: Application of learning in the classroom by pre-service teachers (PST). *Social*

- Sciences & Humanities Open, 3(1). doi:<https://doi.org/10.1016/j.ssaho.2021.100110>
- Spratt, M., Humphreys, G. & Chan, V. 2002. Autonomy and motivation: which comes first? *Language Teaching Research*, 6(3), 245–266. doi:10.1191/1362168802lr106oa
- UNESCO. (2022). *Sustainable Development Goal 4 (SDG 4)*. UNESCO. Retrieved from <https://www.sdg4education2030.org/the-goal>
- University of Texas Arlington. (13 May, 2020). Good Teachers Are the Key to Student Success. *University of Texas Arlington*. Retrieved from <https://academicpartnerships.uta.edu/articles/education/good-teachers-key-to-student-success.aspx>
- Walters, J. & Frei, S. 2007. *Managing Classroom Behavior and Discipline*. Oceanus,. United States of America: Shell Education.



UNIVERSITI
MALAYSIA
KELANTAN

Kerelevanan Penggunaan Tulisan Jawi Dalam Buku Teks Pendidikan Islam Sekolah Rendah

Ahmad Naquiuddin bin Husin
Fakulti Pendidikan, Universiti Kebangsaan Malaysia
p111214@siswa.ukm.edu.my

Mohd Isa bin Hamzah
Fakulti Pendidikan, Universiti Kebangsaan Malaysia
isa_hamzah@ukm.edu.my

ABSTRAK

Tulisan Jawi merupakan warisan yang perlu dipertahankan dan dipelihara sebaiknya. Peranan yang ditunjukkan dalam penyebaran ilmu dan digunakan sebagai tulisan rasmi menjadikannya sangat istimewa di hati bangsa Melayu khususnya. Kementerian Pendidikan Malaysia (KPM) telah menjadikan jawi sebagai satu bidang dalam mata pelajaran Pendidikan Islam. KPM begitu komited dalam memastikan tulisan jawi terus dimartabatkan dengan mewujudkan program J-QAF yang mana salah satu komponen utamanya ialah Pemulihan Jawi. Begitu juga, buku teks Pendidikan Islam Sekolah Rendah daripada tahun satu sehingga tahun enam ditulis menggunakan tulisan jawi. Hal ini menimbulkan keresahan beberapa pihak khususnya ibu bapa yang kurang mahir dalam tulisan jawi. Maka, kajian ini bertujuan untuk menilai kerelevanan penggunaan tulisan jawi dalam buku teks. Pengkaji menggunakan kajian kepustakaan untuk melihat faktor yang menyebabkan tulisan jawi sukar untuk dikuasai oleh murid sekolah rendah. Berdasarkan kajian-kajian lepas, penguasaan tulisan jawi untuk murid sekolah rendah pada tahap lemah dan sederhana. Perkembangan tulisan jawi di Nusantara dan ciri-ciri fizikal serta padanan fonem dengan tulisan rumi turut disertakan dalam kajian ini. Kajian ini juga menjelaskan kepentingan tulisan jawi dalam Pendidikan Islam dan cadangan untuk pihak yang berkaitan bagi memastikan tulisan jawi yang digunakan buku teks kekal relevan.

Kata kunci: *Tulisan Jawi, Relevan, Pendidikan Islam, Sekolah*

ABSTRACT

Jawi writing is a heritage that needs to be defended and preserved. The role shown in the dissemination of knowledge and used as an official writing makes it very special in the hearts of the Malays in particular. The Malaysian Ministry of Education (KPM) has made Jawi a field in Islamic Education subjects. KPM is committed to ensuring that Jawi writing continues to be dignified by establishing the J-QAF program, one of the main components of which is Jawi Restoration. Similarly, Islamic Education textbooks for Primary Schools from year one to year six are written using Jawi script. This causes anxiety among some parties, especially parents who are not proficient in Jawi writing. Therefore, this study aims to evaluate the relevance of using Jawi writing in textbooks. The researcher used a literature review to see the factors that cause Jawi writing to be difficult for primary school students to master. Based on past studies, the mastery of Jawi writing for primary school students is at a weak and moderate level. The development of Jawi writing in the archipelago and the physical characteristics and matching of phonemes with the Roman writing are also included in this study. This study also explains the importance of Jawi writing in Islamic Education and recommendations for relevant parties to ensure that Jawi writing used in textbooks remains relevant.

Keywords: *Jawi writing, Relevant, Islamic Education, School*

PENGENALAN

Peranan tulisan Jawi dalam penyebaran Islam di Nusantara khususnya Tanah Melayu yang mana dikenali kini sebagai Malaysia tidak boleh dinafikan. Kemunculan tulisan Jawi atau dikenali sebagai tulisan Melayu abjad Arab ini telah digunakan sebagai tulisan rasmi Melayu sejak sebelum abad ke 14 Masihi. Tulisan Jawi juga menjadi sebab utama berlakunya perubahan yang besar bagi bangsa Melayu ke arah yang lebih baik sama ada daripada segi agama, cara berfikir, gaya hidup dan juga kebudayaan (Mohd Alwee, 2005). Bukan itu sahaja, beberapa huruf hijaiyah juga telah diadaptasi sesuai dengan sebutan lidah orang Melayu dan membentuk beberapa huruf baru seperti gha, cha dan nya (Rasyidah Ibrahim et al, 2019).

Tulisan Jawi menjadi tulisan utama dalam buku-buku agama yang dikenali sebagai kitab kuning dan ini satu petanda bahawa tulisan Jawi memberi peranan besar dalam perkembangan Islam di Malaysia. Selain itu, menurut Muhammad Endut (1992) dalam Rasyidah et al (2019) murid-murid yang mampu membaca tulisan Jawi kebiasaannya boleh membaca al-Quran dengan baik. Maka, betapa pentingnya untuk menguasai tulisan Jawi agar dapat memahami Pendidikan Islam dengan baik. Melihat kepada kurikulum, tulisan Jawi telah diiktiraf oleh Kementerian Pendidikan Malaysia (KPM) dan diajar secara rasmi dalam subjek Pendidikan Islam. Di samping itu, buku teks Pendidikan Islam juga ditulis sepenuhnya dalam tulisan Jawi. Bukan itu sahaja, munculnya program Jawi, al-Quran, Arab dan Fardhu ain (j-QAF) pada tahun 2004 bagi memperkuatkan dan memperkasa pengajaran Pendidikan Islam khususnya tulisan Jawi. Selain itu, diwujudkan Kem Cemerlang Jawi (KCJ) bagi membantu secara khusus murid-murid yang lemah dan tidak menguasai tulisan jawi.

Isu Utama

Pendidikan Islam di Malaysia jika dilihat dari sudut sejarah pendidikan, buku-buku atau disebut sebagai kitab bagi buku agama serta teks yang dipelajari ditulis menggunakan tulisan Jawi. Sebagai contoh buku agama bertulisan jawi yang digelar kitab kuning digunakan di institusi pengajian seperti pondok dan madrasah. Tulisan jawi menurut Syed Muhammad Naquib al-Attas (1990) ialah huruf-huruf Arab yang diubahsuai dan ditambah mengikut kesesuaian lidah orang Melayu bagi membantu proses belajar dan mengajar dengan lebih mudah. Maka, dapat difahami bahawa tulisan jawi merupakan medium asas untuk proses pembelajaran ketika itu.

Namun, zaman silih berganti tulisan Jawi kelihatan seolah-olah dipinggirkan dan dianggap tidak penting oleh segelintir pihak. Hal ini dapat dilihat apabila munculnya bantahan terhadap tulisan Jawi dan Khat pada tahun 2019 yang ingin dimasukkan dalam buku teks Bahasa Melayu untuk murid tahun empat, lima dan enam sebanyak enam muka surat sahaja. Bantahan tersebut telah diutarakan oleh Persekutuan Persatuan-persatuan Lembaga Pengurus Sekolah Cina Malaysia atau lebih dikenali sebagai Dong Zong. Bukan itu sahaja, timbul juga beberapa rungutan dalam kalangan ibu bapa khususnya yang mempunyai anak tahap satu iaitu tahun satu, dua dan tiga berkaitan keperluan buku teks Pendidikan Islam masih ditulis dalam tulisan Jawi. Hal ini kerana mereka beranggapan kesukaran murid tahap satu untuk memahami tulisan Jawi terutama untuk mengulangkaji semula pelajaran tanpa bimbingan guru. Bukan itu sahaja, tidak semua ibu bapa mahir tulisan Jawi dan tidak mampu membantu anak mereka untuk membaca tulisan Jawi.

Masalah murid lemah dalam jawi ini bukanlah satu masalah baru terjadi bahkan menurut Saiful Bahari (2020), terdapat murid yang tidak mengenali huruf tunggal jawi yang mana akan membawa kepada mereka tertinggal berbanding rakan seusia yang telah menguasainya dengan baik. Murid akan mengalami kesukaran untuk mengenalpasti huruf seandainya asas jawi tidak dikuasai dengan baik. Muzni (1995) pula berkata murid lebih ketara

kelemahannya dalam menulis jawi berbanding membaca tulisan jawi. Hal ini menunjukkan ada murid yang mampu membaca dengan baik namun tidak mampu menulis dengan baik.

Maka, sesuatu perlu dilakukan bagi membantu murid menguasai penulisan jawi yang mana rata-ratanya berpunca daripada tidak mengenal huruf jawi, sambungan jawi dan kurang latihan menulis. Penekanan harus diberikan ketika di tahun satu lagi kerana ianya merupakan asas yang dipelajari pada waktu tersebut.

Kecenderungan murid terhadap tulisan jawi dilihat kurang memberangsangkan. Sebagai contoh kajian Nik Rosila (2007) di Shah Alam dan Kuala Lumpur yang melibatkan dua buah sekolah menengah iaitu 400 orang responden daripada tingkatan 2 dan tingkatan 4 menunjukkan penguasaan jawi yang lemah. Antara kriteria yang diuji ialah kemahiran menulis dan mengeja jawi, soalan aneka pilihan, menulis soalan esei dan kemahiran menulis ayat al-Quran. Menurut Saiful Bahri (2020) pula, pemerhatian dan penilaian di sebuah SJKC di Melaka juga mendapati 30% daripada murid tahun enam yang mengambil mata pelajaran jawi telah mendapat gred E. Hal ini sudah pastinya amat membimbangkan dan menunjukkan murid masih lemah dalam penguasaan tulisan jawi. Tulisan jawi perlu disemai rasa cinta dalam jiwa murid-murid untuk berminat mempelajarinya. Tulisan ini bukan sekadar warisan bangsa semata-mata namun ianya boleh membantu murid khususnya untuk memahami isi pelajaran dalam buku teks.

Perkembangan Tulisan Jawi

Penemuan Batu Bersurat Terengganu pada 1303 masihi dan tercatat tulisan Jawi di batu tersebut menunjukkan bahawa tulisan jawi telah wujud dan digunakan sebelum tahun 1303 masihi lagi (Syed Naquib, 2015). Perkataan jawi berasal daripada bahasa arab yang dijadikan adjektif iaitu 'Jawah' yang menjadi 'Jawi'. Tulisan jawi memainkan peranan ketika itu sebagai tulisan utama dalam pentadbiran seperti urusan mesyuarat dan juga untuk menulis bahan-bahan lain seperti buku, kitab agama, hukum kanun mata wang, batu nisan, catatan pentadbiran dan lain-lain lagi (Amat Juhari, 1995). Tulisan jawi juga menjadi tulisan rasmi semua peutusan dan perdagangan di kepulauan Nusantara dan bahasa Melayu menjadi *lingua franca* ketika itu. Dari sudut pendidikan, sebelum kedatangan penjajah Inggeris dan Belanda, tulisan jawi menjadi kebangsaan agama, bangsa dan negara kerana ianya merupakan medium utama dalam menyebarkan ilmu pengetahuan. (Azrulhizam et al, 2020). Antara bukti lain berkenaan tulisan jawi ialah pembukuan kepingan-kepingan manuskrip seperti Majalah Ahkam dan Hukum Kanun Melaka sebagai peninggalan penulisan Jawi Lama.

Ketika zaman transisi perkembangan bahasa Melayu kuno kepada Melayu klasik sekitar abad ke 13-14, tulisan jawi telah berjaya mengambil alih peranan sebagai tulisan utama ketika itu sehingga menindakkan tulisan Pallava atau ada juga yang menyebut sebagai tulisan Kawi yang telah dianggap tidak sesuai lagi untuk digunakan (Zurina dan Adi Yusran, 2020). Pada abad ke 20 Masihi, tulisan jawi masih lagi digunakan bagi urusan surat menyurat dengan pihak penjajah Inggeris. Namun, setelah itu pihak penjajah mula mempersoalkan dan bertegas untuk menaikkan tulisan rumi sebagai tulisan rasmi kerana ianya dikatakan lebih praktikal dan mudah kerana pemerintah ketika itu sudah pun menggunakan tulisan rumi untuk tujuan pentadbiran.

Akta Bahasa yang digubal pada tahun 1963 dikatakan merupakan satu detik kemerosotan tulisan jawi kerana kata tersebut menetapkan tulisan Rumi sebagai tulisan rasmi Bahasa Melayu. Maka, setelah itu tulisan Rumi lebih banyak digunakan dalam kehidupan seharian berbanding tulisan jawi. Penetapan akta ini juga memberi kesan yang besar terhadap tulisan Jawi sehingga berlakunya sebilangan besar generasi muda ketika itu yang tidak mahir membaca dan menulis jawi (Hashim dan Adi Yasran, 2009).

Ciri-ciri Fizikal Tulisan Jawi

Tulisan Jawi mempunyai ciri-ciri fizikal tertentu yang boleh dibahagikan kepada tiga perspektif (Khazriyati Sallehuddin, 2012) iaitu pertama cara membacanya, kedua bentuk setiap huruf Jawi dan ketiga ciri-ciri yang ditonjolkan oleh setiap huruf jawi. Tulisan jawi juga dipengaruhi oleh huruf Arab daripada segi penulisan dan pembacaannya yang dimulakan dari belah kanan ke kiri berbeza dengan tulisan kebanyakan seperti tulisan rumi yang ditulis dan dibaca dari kiri ke kanan. Bergerak kepada huruf jawi, ianya boleh dipadankan dengan satu fonem bahasa Melayu. Fonem merupakan unit bunyi terkecil yang boleh membezakan makna sesuatu perkataan (Kamus Dewan Edisi Keempat).

Bukan itu sahaja, huruf jawi juga ada yang seakan serupa bentuknya dan hanya dibezakan dengan jumlah titik sahaja seperti huruf ha', jim dan kha'. Tulisan jawi juga jika diamati sangat berbeza dengan tulisan rumi kerana ianya boleh disambung-sambung di antara huruf-huruf jawi yang boleh bersambung. Hal ini seakan-akan menjadikan tulisan jawi sangat kompleks namun ianya tidaklah sesusah yang disangka untuk difahami.

Berikut merupakan padanan huruf jawi dengan huruf rumi.

Huruf Jawi	Padanan Rumi
ا	a
ب	b
ت	t
ث	h, t (t)
ج	s (th)
چ	j
ح	h (h)
خ	kh
د	d
ذ	z (dh)
ر	r

UNIVERSITI
MALAYSIA
KELANTAN

Huruf Jawi	Padanan Rumi
ز	z
س	s
ش	sy (sh)
ص	s (ş)
ض	d (d)
ط	t (t)
ظ	z (z)
ع	a, k (')
غ	gh
ف	f
ق	k, q, (q)
ك	k
ل	l
م	m
ن	n
و	w, o, u
و	v
ه	h
ح	k (')
ي	y, i, e (taling)
ج	c
ن	ng
پ	p
گ	g
پ	e (pepet)
ن	ny

Padanan-padanan Rumi yang diberikan di dalam kurungan ialah padanan-padanan yang digunakan untuk mengeja istilah-istilah pinjaman bahasa Arab.

Rajah 2 : Padanan Huruf Jawi –Huruf Rumi (DBP, 1988)

Pendidikan Islam di Malaysia

Pendidikan merupakan satu perkara yang sangat diberi perhatian oleh Islam. Bahkan wahyu pertama iaitu ayat 1-5 Surah al-‘Alaq mengajak manusia untuk membaca, meneroka, meneliti dan menuntut ilmu supaya menjadi orang yang berguna dan bermanfaat untuk diri dan masyarakat. Pendidikan bukan semata-mata perpindahan info atau maklumat daripada guru kepada murid tetapi ianya satu proses membangunkan seorang insan yang cemerlang menurut kaca mata Islam (Yaacob dan Che Bakar, 2004). Sebagaimana kita melihat Rasulullah s.a.w. mendidik para sahabat menjadi orang yang hebat dan berjaya sehingga ada 10 orang sahabat yang masih hidup namun telah dijanjikan syurga oleh Allah s.w.t.

Falsafah Pendidikan Kebangsaan iaitu ‘Pendidikan di Malaysia adalah suatu usaha berterusan ke arah lebih memperkembangkan potensi individu secara menyeluruh dan bersepadu untuk mewujudkan insan yang seimbang dan harmonis dari segi intelek, rohani, emosi dan jasmani, berdasarkan kepercayaan dan kepatuhan kepada Tuhan. Usaha ini adalah bagi melahirkan warganegara Malaysia yang berilmu pengetahuan, berketerampilan,

berakhlak mulia, bertanggungjawab dan berkeupayaan mencapai kesejahteraan diri, serta memberi sumbangan terhadap keharmonian dan kemakmuran keluarga, masyarakat dan negara.' Jelas sekali falsafah ini bertepatan dengan apa yang Islam gariskan iaitu bukan sahaja membina manusia yang hanya berjaya pada satu aspek namun berusaha melahirkan manusia yang memiliki jiwa dan peribadi yang seimbang dari segala segi.

Falsafah Pendidikan Islam pula ialah 'Pendidikan Islam adalah satu usaha berterusan untuk menyampaikan ilmu, kemahiran dan penghayatan ilmu, kemahiran dan penghayatan Islam berdasarkan al-Quran dan as-Sunnah bagi membentuk sikap kemahiran, keperibadian dan pandangan hidup sebagai hamba Allah yang mempunyai tanggungjawab untuk membangun diri, masyarakat, alam sekitar dan Negara ke aras mencapai kebaikan di dunia dan kesejahteraan di akhirat.'

Jika diamati kedua-dua falsafah tersebut dapat dilihat bahawa pendidikan bukan sahaja bertumpu kepada urusan di dunia sahaja bahkan juga untuk kehidupan seterusnya. Pendidikan Islam secara khususnya menjadi al-Quran dan as-Sunnah sebagai panduan dan pedoman utama. Al-Abrasy dalam Imam Syafei (2015) mengatakan tujuan Pendidikan Islam itu ada lima iaitu membentuk peribadi dan akhlak yang mulia. Inilah misi kerasulan Rasulullah s.a.w, mempersiapkan murid untuk kehidupan dunia dan akhirat, mempersiapkan murid dalam mencari rezeki yang sebaiknya dan profesional. Dalam erti kata lain mampu berdikari dan tidak meminta-minta, memberi motivasi dan mewujudkan semangat ilmiah kepada murid untuk sentiasa belajar dan mengkaji ilmu dan mempersiapkan murid yang profesional dalam bidang kemahiran dan pertukangan.

Berdasarkan pandangan di atas ini, jelaslah bahawa Pendidikan Islam itu syumul dan sentiasa menitikberatkan keperluan dan realiti kehidupan seseorang. Pendidikan Islam tidaklah hanya mementingkan kehidupan di akhirat semata-mata namun menjadikan kehidupan di dunia sebagai jambatan ke akhirat.

Melihat kepada Pendidikan Islam di Malaysia, Pendidikan Islam merupakan subjek yang wajib diambil oleh setiap murid yang beragama Islam. Beberapa perubahan telah berlaku melibatkan kurikulum khususnya untuk Pendidikan Islam antaranya Kurikulum Baru Sekolah Rendah (KBSR) dan Kurikulum Baru Sekolah Menengah (KBSM) sehingga munculnya PAFA iaitu Penilaian Asas Fardhu Ain yang bertujuan untuk menguji kemampuan murid dalam pengetahuan fardhu ain seperti aqidah, fiqh dan akhlak. Seterusnya kini Kurikulum Standard Sekolah Rendah (KSSR) dan Kurikulum Standard Sekolah Menengah (KSSM) pula diperkenalkan. Melalui setiap kurikulum ini, Pendidikan Islam sentiasa ditambahbaik dan memastikan ilmu yang bakal disampaikan kepada murid sesuai dengan kemampuannya.

Kebiasaannya masa yang diperuntukkan di sekolah kebangsaan ialah 180 minit dalam seminggu manakala Sekolah Jenis Kebangsaan Cina dan Sekolah Jenis Kebangsaan Tamil sebanyak 150 minit dalam seminggu (KPM, 2013). Waktu tersebut dipecahkan untuk al-Quran, Ulum iaitu Hadith, Aqidah, Fiqh, Sirah dan Adab serta Pelajaran Jawi.

Penggunaan tulisan Jawi dalam Buku Teks

KPM pada tahun 1985 telah mewajibkan tulisan Jawi di sekolah rendah agama dan tiga masa diperuntukkan untuk peringkat darjah tiga sekolah rendah (Norhazliana et al, 2010). Hal ini merupakan satu langkah yang cukup baik bagi memartabatkan semula tulisan jawi dalam sistem pendidikan di Malaysia. Namun pada 1990, pelajaran Jawi diajar mulai darjah satu setelah melihat pencapaian dan pelaksanaannya kurang memuaskan. Penggunaan tulisan Jawi dalam buku teks bukanlah perkara yang baru bahkan ianya telah digunakan sejak zaman dahulu lagi iaitu buku-buku agama ditulis dalam tulisan jawi. Merujuk kepada pendidikan secara formal di bawah KPM, buku teks Pendidikan Islam ditulis dalam tulisan jawi bagi tahun satu sehingga tahun enam. Menurut Nik Rosila (2007), sistem pendidikan di Malaysia bermula

dengan tulisan jawi apabila buku-buku untuk pembelajaran dan pengajaran ditulis dalam tulisan jawi dan ada juga dalam bahasa Arab.

Buku Teks Pendidikan Islam dalam bidang Jawi menekankan kemahiran-kemahiran yang perlu dipelajari dan dikuasai oleh murid. Antara kemahiran jawi atau tajuk bidang jawi sekolah rendah mengikut tahun ialah ;

TAHUN	KEMAHIRAN JAWI/ TAJUK
1	Huruf tunggal, suku kata terbuka dan suku kata tertutup
2	Perkataan tiga suku kata atau lebih dan rangkai kata
3	Imbuan awalan, imbuan akhiran dan imbuan apitan
4	Kedudukan hamzah, perkataan ejaan tradisi dan perkataan pinjaman bahasa asing
5	Teks cerita dan Khat Nasakh
6	Teks cerita dan Khat Riq'ah

Jadual: Kemahiran Jawi mengikut tahun (Muhammad Fuad dan Hafizhah Zulkifli, 2022)

Kemahiran Jawi yang dinyatakan di atas ini merupakan interpretasi daripada buku Pedoman Ejaan Jawi yang Disempurnakan (PEJYD) yang diterbitkan secara rasmi oleh DBP. Hal ini selaras dengan Surat Pekeliling Ikhtisas bil 1/1992 yang mengatakan buku PEJYD hendaklah digunakan di semua institusi pendidikan dan yang berkaitan dengannya serta masyarakat di seluruh negara. Hal ini dapat disimpulkan bahawa tulisan jawi juga mengalami perubahan demi perubahan bagi memastikan ianya kekal relevan dan mudah ditulis dan difahami.

USAHA MEMARTABATKAN TULISAN JAWI

Antara usaha memartabatkan tulisan jawi yang telah sedia maklum ialah pelaksanaan program J-QAF merupakan hasil cetusan idea mantan Perdana Menteri iaitu Tun Abdullah bin Ahmad Badawi ketika beliau melakukan lawatan rasmi ke KPM pada tahun 2003. Ketika itu beliau telah meluahkan pandangan untuk menyaksikan murid-murid sekolah rendah khususnya dapat membaca dan menguasai al-Quran dengan baik sebelum mereka melangkah ke Sekolah Menengah. Cetusan idea ini telah dibentangkan dan diperincikan oleh KPM dan beberapa agensi yang turut memberikan buah fikiran. Akhirnya pada tahun 2005, program J-QAF telah dapat dihasilkan dan mendapat persetujuan oleh YAB Perdana Menteri ketika itu dan dijalankan secara berperingkat-peringkat bermula tahun 2005.

Program J-QAF

J-QAF merupakan singkatan kepada Jawi- al-Quran, Bahasa Arab dan Fardhu Ain merupakan satu inisiatif yang baik daripada KPM untuk memperkasakan Pendidikan Islam melalui PdPC yang ada dalam komponen J-QAF. Pembahagian J-QAF kepada komponen ini memberi petunjuk bahawa pentingnya perkara tersebut untuk dikuasai oleh setiap murid. Program ini berpandukan model dan modul yang dibina oleh golongan bijak pandai dalam bidang masing-masing (Mohd Azmir dan Mohd Azrani, 2010). Bukan itu sahaja, program ini juga membuka peluang kepada ramai graduan universiti khususnya dalam bidang Pendidikan Islam dan Bahasa Arab untuk menjadi tenaga pengajar J-QAF yang mana mereka diberikan latihan khusus berkaitan pedagogi dan selok-belok dunia pendidikan. Fungsi tenaga pengajar ini adalah untuk memberi bimbingan, kemahiran, pengukuhan dan pemulihan serta penghayatan murid terhadap Pendidikan Islam.

Objektif program J-QAF secara ringkas akan membantu murid Islam sekolah rendah untuk :

1. Menguasai ejaan, bacaan dan mahir dalam penulisan jawi
2. Membaca al-Quran sehingga khatam ketika berada pada tahun enam
3. Menguasai Bahasa Arab dengan baik.
4. Memantapkan dan menghayati amalan Fardhu Ain dalam kehidupan seharian.

Komponen J-QAF

J-QAF mempunyai empat komponen utama iaitu Model Kelas Pemulihan Jawi, Model Khatam a-Quran, Model Perluasan Pelaksanaan Bahasa Arab Komunikasi dan Modul Bestari Solat. Pengkaji menerangkan Model Pemulihan Jawi sahaja iaitu ;

Model Kelas Pemulihan Jawi

Kelas Pemulihan Jawi merupakan diterangkan dalam Buku Panduan Pelaksanaan Model Kelas Pemulihan Jawi. Guru Pemulihan Jawi akan memainkan peranan untuk mengajar kelas ini di samping mengajar jawi berdasarkan jadual masing-masing dengan menggunakan modul PdPc yang telah disediakan oleh KPM. Terdapat satu program yang kebiasaannya dijalankan 2 kali dalam setahun iaitu Kem Cemerlang Jawi (KCJ) yang mensasarkan murid yang lemah dalam penguasaan tulisan jawi dan diberi modul serta guru sebagai fasilitator untuk membimbing murid tersebut. Pada tahun 2012, pemurnian program J-QAF telah dilakukan yang mana pemulihan jawi tahun 1 telah ditiadakan digantikan dengan program KCJ iaitu pemulihan jawi yang lebih menyeluruh yang melibatkan semua tahun, Pelaksanaan KCJ ini menjadi bukti bahawa KPM sentiasa memandang serius kepada perkembangan tulisan jawi sama seperti berlakunya perubahan pada mata pelajaran lain (Rasyidah et al, 2019).

KAJIAN LEPAS

Berdasarkan kajian yang lepas , antara punca tulisan jawi tidak menjadi pilihan pengguna yang berbahasa Melayu untuk menggunakannya dalam urusan seharian ialah kerana kerumitan kognitif jawi itu sendiri yang berbeza dari segi morfologi dan fonologi dengan bahasa Melayu atau tulisan rumi. Ianya berdasarkan kajian oleh Khazriyati Salehuddin (2012) yang menjelaskan bahawa satu usaha drastik dan berani perlu dilakukan supaya untuk membantu kerumitan tulisan jawi supaya bukan sahaja dianggap semata-mata sebagai warisan bangsa akan tetapi penggunaannya dalam dipergiat dan popular seperti di Nusantara suatu masa dahulu. Kajian ini dilihat lebih memfokuskan berkaitan kerumitan untuk membaca tulisan jawi dari sudut kognitif dan perbandingan dengan tulisan rumi.

Murid-murid yang mempunyai ibu bapa yang tiada pendedahan awal mengenai tulisan jawi sedikit sebanyak mempengaruhi prestasi murid tersebut, bahkan sifat negatif murid terhadap tulisan jawi juga menjadi faktor lemah dalam penguasaan tulisan jawi (Siti Fatimah, 2006). Maka, usaha untuk meningkatkan penguasaan tulisan jawi supaya ianya kekal relevan bukan sahaja pada diri murid itu bahkan perlukan sokongan ibu bapa dan sekeliling.

Menurut Suhana et al (2016) yang melakukan kajian terhadap Sekolah Rendah Agama Zon 2, Pasir Gudang mendapati tahap penguasaan tulisan jawi murid adalah sederhana. Bukan itu sahaja, kemahiran membaca tulisan jawi mendahului kemahiran menulis. Analisis kajian tersebut juga menunjukkan betapa pentingnya penguasaan tulisan jawi dimulakan sejak awal

kanak-kanak dan ianya dilazimioleh semua pihak sama ada murid, ibu bapa, guru dan juga pentadbiran sekolah.

Antara faktor yang menjadi penyebab berlakunya kelemahan dalam pelajaran jawi di Kedah menurut Abdul Razak (1998) dalam Saiful Bahri (2020) terdapat empat sebab utama ;

1. Masa untuk pelajaran jawi di sekolah tidak mencukupi.
2. Guru-guru tidak mengamalkan amalan pengajaran yang sesuai dan tidak mempunyai kemahiran khusus dalam pelajaran jawi
3. Alat bantu mengajar berkaitan jawi berkurangan
4. Murid-murid menghadapi masalah apabila guru menggunakan tulisan jawi dalam pengajaran. Hal ini kerana murid tidak memahami tulisan jawi.

Tidak dinafikan juga guru juga menjadi penyumbang kepada kurangnya penguasaan murid dalam tulisan jawi iaitu melalui amalan pengajaran guru itu sendiri. Kajian oleh Nur Syamira et al (2017) menyatakan dapatan bahawa antara penyebab murid lemah dalam jawi kerana PdPc guru yang kurang berkesan dan kurang memberangsangkan untuk menarik minat pelajar. Antara puncanya daripada ilmu dan pengalaman guru itu sendiri kerana pengajaran Pendidikan Islam memerlukan kemahiran khusus dalam Jawi di samping penguasaan ilmu berkaitan jawi itu sendiri (Bashah et al, 2012).

Guru boleh menggunakan beberapa kaedah pengajaran yang sesuai bagi menarik minat murid antaranya seperti yang dinyatakan oleh Naquiah Nahar dan Jimain Safar (2016) iaitu kaedah pandang sebut, kaedah abjad, kaedah fonetik, kaedah permainan, kaedah latih tubi, kaedah imlak, kaedah nyanyian dan kaedah mengeja atau disebut membatang. Semua kaedah ini boleh diperhalusi oleh guru dan tetntukan yang mana paling sesuai untuk digunakan ketika PdPc.

Minat murid terhadap tulisan Jawi

Antara perkara penting yang perlu dipupuk ialah minat terhadap tulisan jawi. Nik Rosila (2007) dalam dapatan kajiannya mendapati 39.8 peratus menyatakan 'suka jika waktu Pendidikan Islam berlalu dengan cepat,' menunjukkan bahawa pelajar tidak berminat dengan mata pelajaran Pendidikan Islam. Dapatan itu juga mendapati semakin baik penguasaan pelajar dalam jawi maka semakin kurang minat mereka terhadap mata pelajaran Pendidikan Islam. Selain itu, Hasil kajian juga menunjukkan 43 peratus pelajar Tingkatan 2 dan 4 menyatakan "selalu membuat kerja lain semasa guru sedang mengajar Pendidikan Islam". Berdasarkan jadual rujuk silang, 40.9 peratus pelajar yang lemah dalam penguasaan Jawi dan 48 peratus pelajar yang baik dalam penguasaan Jawi menyatakan "selalu" dan "kadang-kadang" membuat kerja lain semasa guru sedang mengajar Pendidikan Islam, iaitu ianya memberi makna tidak berminat terhadap mata pelajaran ini.

Dapatan ini memperlihatkan peratus pelajar baik dalam penguasaan Jawi yang tidak berminat terhadap Pendidikan Islam adalah tinggi. Dapatan ini juga berguna buat guru kerana minat murid terhadap sesuatu subjek juga dipengaruhi dengan cara guru menyampaikan ilmu tersebut.

Sikap murid terhadap tulisan jawi

Antara yang memberi kesan kepada kelemahan dalam menguasai tulisan jawi ialah sikap pelajar itu sendiri. Menurut Awang Mohamad Amin (1989), pelajar menganggap tulisan jawi ini tidak penting dan mempunyai sikap yang negatif dan skeptikal terhadap tulisan jawi.

Mereka menganggap ianya sukar dipelajari dan tidak dinilai dalam ujian. Bayangkan kajian pada tahun 1989 telah mendapat dapatan sebegini, bagaimana pula untuk 2022? Jawapannya ialah sikap yang sama masih wujud dan ianya menyebabkan pelajar ketinggalan dan kurang dapat menghayati isi pelajaran Pendidikan Islam, al-Quran as-Sunnah dan Syariah Islamiah. Selain itu, dapat juga disimpulkan, kelemahan penguasaan tulisan jawi di sekolah menengah secara tidak langsung berpunca dan berlaku sejak seseorang pelajar di sekolah rendah lagi.

Menurut kajian Saiful Bahri (2020) berkaitan sikap murid sekolah rendah berkaitan penguasaan tulisan jawi. Antara item yang mendapat skor min yang tinggi ialah ‘ Saya selalu bersikap endah tidak endah terhadap pengajaran guru ketika subjek jawi dalam buku teks Pendidikan Islam.’ dan item ‘ Saya berasa senang hati apabila guru tidak menyoal saya untuk menulis jawi.’ Berdasarkan dua item dapat difahami bahawa apa yang ditanam dalam pemikiran murid itu berkaitan tulisan jawi yang susah ini telah menyebabkan wujudnya sikap yang tidak sepatutnya.

Menurut Amrina Rasyada dan Nik Md Saiful (2019), antara faktor yang menjadikan murid cemerlang dan mampu menguasai tulisan jawi dengan baik ialah ; konsep diri akademik yang positif, kemahiran genetik yang baik, mempunyai cita-cita dan penglihatan yang jelas serta seorang yang berdisiplin.

Motivasi murid untuk mempelajari tulisan Jawi

Motivasi merupakan perkara yang sangat penting dalam menggerakkan murid untuk melakukan sesuatu bagi menguasai tulisan jawi. Motivasi bukan sahaja datang daripada dalam diri murid itu sendiri sahaja bahkan juga sokongan padu daripada ibu bapa khususnya dan juga guru. Sokongan daripada guru khususnya ketika PdPc berjalan, guru perlu memainkan peranan yang dalam PdPc Jawi supaya dapat merangsang murid untuk meminati dan berjaya dalam mata pelajaran (Muhammad Fuad dan Hafizhah Zulkifli, 2022). Selain itu, ibu bapa juga perlu memainkan peranan berdasarkan kajian Saiful Bahri (2020) bagi menyediakan bahan bacaan dalam tulisan jawi yang bersesuaian dengan anak mereka. Nilai min 2.26 bagi item ‘saya mempunyai bahan bacaan di rumah’ menunjukkan kurangnya sokongan daripada ibu bapa berkaitan bahan bacaan bercetak. Tidak dinafikan kini bahan bacaan boleh sahaja diakses terus dalam internet namun adakalanya bahan bercetak lebih memberi motivasi untuk membacanya.

KEPENTINGAN TULISAN JAWI DALAM PENDIDIKAN ISLAM

Tulisan jawi memainkan peranan penting dalam dunia Pendidikan Islam khususnya dan ini merupakan sebab yang utama mengapa tulisan jawi perlu dipertahan dan dipelihara sebaiknya.

Tulisan Jawi sebagai tulisan utama pendidikan

Ketika zaman dahulu, tulisan jawi yang menjadi tonggak utama dalam penyebaran Islam di Nusantara. Hal ini dapat dilihat melalui kitab-kitab kuning yang membicarakan pelbagai ilmu Islam bukan sahaja ilmu Fardhu Ain tetapi juga cabang-cabang ilmu yang lain. Meskipun kitab-kitab kuning tersebut ada yang telah dialih bahasa ke tulisan Rumi namun masih terdapat pondok pengajian, kuliah di surau dan masjid yang masih mengekalkan penggunaan kitab bertulisan jawi ini. Meskipun zaman berlalu namun tulisan jawi masih kekal relevan.

Tulisan Jawi sebagai medium asas pengajaran Pendidikan Islam

Tulisan jawi yang diadaptasi daripada huruf arab ini dan beberapa pertambahan huruf yang disesuaikan dengan lidah orang Melayu menunjukkan betapa bijaknya ahli ilmu ketika itu yang

berfikir untuk mewujudkan tulisan ini. Kini, tulisan jawi terus disemak dan diperbaiki seperti dalam buku Pedoman Ejaan yang Disempurnakan (PEJYD) bagi memastikan ianya mudah dibaca dan difahami. Tulisan ini juga masih kekal digunakan dalam buku teks Pendidikan Islam Sekolah Rendah dan juga di sekolah agama. Maka, seperti yang dinyatakan oleh Nik Rosila (2007) pelajaran jawi bermatlamat untuk memastikan murid dapat memahami pelbagai bidang ilmu dalam Pendidikan Islam.

Membantu Mengatasi Murid yang lemah

Program J-QAF antara program utama yang banyak membantu murid untuk menguasai tulisan jawi. Namun tidak dinafikan terdapat juga murid yang masih lemah dalam penguasaan tulisan jawi. Maka, disinilah peranan guru untuk membimbing dan membantu murid untuk berminat, belajar membaca, belajar menulis dan seterusnya dapat menguasai tulisan jawi.

Warisan Berharga yang Perlu Dipertahankan

Tulisan jawi mempunyai nilai yang tinggi dan sangat sinonim dengan Melayu dan Islam itu sendiri. Hal ini kerana penyebaran Islam itu sendiri di Nusantara melalui buku-buku yang ditulis dalam tulisan jawi. Bukan itu sahaja, tulisan jawi juga merupakan simbol perjuangan orang dahulu untuk membawa perubahan dan kemajuan bangsa Melayu. Maka, menjadi satu kemestian kepada setiap orang Islam untuk mempelajari tulisan jawi agar dapat memahami intipati kitab-kitab lama atau sekurang-kurangnya dapat membaca tulisan jawi yang asas. Tulisan ini juga perlu dipertahankan penggunaannya di sekolah kerana ianya boleh menjadi jati diri kepada murid.

CADANGAN UNTUK MEMASTIKAN TULISAN JAWI DALAM BUKU TEKS PENDIDIKAN ISLAM KEKAL RELEVAN

Setiap orang perlu memainkan peranan dalam memastikan tulisan jawi mendapat tempat yang selayaknya khususnya dalam bidang pendidikan. Antara cadangan bagi memastikan tulisan jawi kekal relevan :

1. Jawatankuasa buku teks, KPM.

KPM perlu mengorak langkah dengan lebih agresif untuk melakukan perubahan terhadap buku teks Pendidikan Islam. Sebagai contoh mewujudkan dwitulisannya iaitu tulisan jawi sebagai tulisan yang dominan manakala tulisan rumi disertakan sekali pada di bawah tulisan jawi tersebut. Tidak perlu semua sekali dirumikan tetapi hanya bahagian-bahagian yang penting sahaja. Selain itu, boleh diwujudkan satu ruangan khas untuk perkataan jawi yang dipadankan dengan perkataan rumi. Ruangan ini boleh dimanfaatkan guru untuk melaksanakan aktiviti mengeja, merumikan atau menjawab perkataan. Perubahan sebegini bukanlah perlu dilaksanakan segera namun yang penting ada usaha ke arah tersebut. Permintaan segelintir pihak untuk menukarkan tulisan jawi kepada tulisan rumi dalam buku teks adalah tindakan yang tidak bertanggungjawab.

2. KPM

Sebagai organisasi nombor satu pendidikan di Malaysia, KPM perlu sentiasa peka dan menjadi pencetus kepada kecintaan terhadap tulisan Jawi. Sekolah-sekolah di bawah KPM boleh dicadangkan supaya menggunakan tulisan jawi untuk papan tanda, kepala surat, kain rentang majlis meskipun ianya tiada kaitan dengan agama Islam. Hal ini kerana segelintir orang menganggap mahir tulisan jawi bererti telah cenderung kepada

Islam. Sedangkan hakikatnya tulisan jawi hanyalah sebagai medium untuk menyampaikan info dan merentas sempadan kaum, bangsa dan agama. KPM juga boleh menggubal dasar mesra jawi supaya setiap sekolah mahupun Sekolah Jenis Kebangsaan Cina dan Sekolah Jenis Kebangsaan Tamil juga turut menggunakan tulisan jawi untuk tujuan yang sesuai tanpa ada rasa rasis.

3. Peranan guru

Guru perlu meningkatkan amalan pengajaran jawi dengan lebih berkesan supaya ianya dapat memupuk minat murid untuk menguasai tulisan jawi. Guru perlu diberi latihan berkaitan pedagogi terbaharu dan ilmu-ilmu berkaitan tulisan jawi yang semakin berkembang supaya guru bersedia untuk menghadapi mehnah dalam mengajar bidang jawi. Penggunaan alatan yang canggih seperti projektor, televisyen di kelas, papan putih pintar juga dapat membantu menjadikan PdPc lebih seronok. Namun, guru perlu berpijak pada realiti bahawa tidak semua sekolah memiliki fasiliti seperti itu maka laksanakanlah dengan apa-apa cara yang mampu menarik minat murid.

4. Ibu bapa

Peranan ibu bapa tidak terkecuali dalam memastikan tulisan jawi kekal relevan. Difahami bahawa kekangan masa ibu bapa untuk membantu anak untuk membaca tulisan jawi namun ianya bukan alasan untuk mengabaikannya. Ibu bapa boleh membantu dari sudut memberi sokongan seperti menyediakan bahan bercetak bertulisan jawi dan juga memberi galakan untuk anak cuba menulis dan membaca tulisan jawi.

5. Media massa dan media sosial.

Pengaruh media massa dan media sosial sangatlah kuat khususnya kepada anak muda. Maka, manfaatkanlah dengan menerbitkan iklan-iklan kesedaran, poster bertulisan jawi video pendek pengajaran jawi ataupun apa-apa bentuk yang dirasakan sesuai.

KESIMPULAN

Kelemahan murid untuk menguasai tulisan jawi perlu diatasi secara bersama. Setiap pihak perlu memainkan peranan untuk memastikan tulisan jawi tidak hilang dan lapuk dek perubahan zaman. Kekurangan yang ada perlu diselesaikan bersama bukan seperti kerana nyamuk, kelambu dibakar. Harapan pengkaji agar tulisan jawi terus digunakan sebagai tulisan utama dalam buku teks Pendidikan Islam Sekolah Rendah dan ianya kekal relevan.

RUJUKAN

- Amat Juhari Moain. (1995). Tulisan jawi sebagai wahana pelestarian bahasa, budaya dan tamadun dunia Melayu. Kongres Bahasa Melayu Sedunia Kumpulan Kertas Kerja Jilid I, 150-162.
- Amrina Rasyada binti Kamaruzaman dan Nik Md Saiful bin Nik Abdullah. (2019). Penulisan Jawi dalam Mata Pelajaran Pendidikan al-Quran dan as-Sunnah di Peringkat Menengah ; Isu dan Cabaran. Jurnal KIAS. Vol 14. Bil XIV.
- Awang Mohamad Amin. (1989). Tulisan Jawi ke Arah Penggunaan Yang Lebih Meluas dan Berkesan. Jurnal Dewan Bahasa, 33(12), 937-941.
- Azulhizam Shapii, Zainal Rasyid Mahayuddin dan Sabarina Othman. (2020). Jom Jawi : Meningkatkan Penguasaan Bahasa Jawi di kalangan Murid Sekolah Rendah Mengguna Media Interaktif. Jurnal Dunia Pendidikan. Vol. 2, No 3, 212- 230.

- Babbie, E.R. (2007). *The Practice of Social Science Research*. Ed ke 9. USA: Thompos Learning.
- Bhasah Abu Bakar, Mohd Nafiruddin Mad Siadid & Abdul Jadid Suwairi. (2012). Persepsi pelajar terhadap keberkesanan program j-QAF dalam kalangan pelajar tingkatan Satu kajian kes. *Seminar Kebangsaan Majlis Dekan Pendidikan IPTA 2012. Johor Bahru*.
- Borhan bin Aripin. (2010). Penilaian Pelajar Terhadap Penggunaan Buku Teks Pendidikan Islam Tingkatan Satu. Disertasi Sarjana. Universiti Kebangsaan Malaysia.
- Chua Yan Piaw. (2021). *Kaedah Penyelidikan. Edisi ke-4*. Kuala Lumpur: McGraw Hill Education (Malaysia) Sdn. Bhd.
- Dewan Bahasa dan Pustaka. (1988). Daftar Ejaan Rumi Jawi. Percetakan Dewan Bahasa dan Pustaka.
- Hashim Musa dan Adi Yasran Abdul Aziz. (2009). Pemerksaan kembali tulisan Jawi. *Jurnal Aswara*, 4(1): 159-176.
- Imam Syafe'i. (2015). Tujuan Pendidikan Islam. *Al-Tadzkiyyah : Jurnal Pendidikan Islam*. Vol 6.
- Kementerian Pendidikan Malaysia. (2013). Surat Pekeliling Ikhtisas Bil 2 Tahun 2013. Pelaksanaan Kurikulum Standard Sekolah Rendah (KSSR) Tahap II Secara Berperingkat –Peringkat Mulai 2014. <https://www.moe.gov.my/pekeliling/2794-surat-pekeliling-ikhtisas-bil-2-tahun-2013-pelaksanaan-kurikulum-standard-sekolah-rendah-kssr-tahap-ii-secara-berperingkat-peringkat-mulai-tahun-2014/file>
- Khazriyati Salehuddin. (2012). Penilaian ke atas Kerumitan Kognitif dalam Proses Membaca Jawi. *GEMA Online Journal of Language Studies*. Volume 12(4).
- Mohd Azmir bin Mohd Nizah dan Mohd Azrani bin Asran. (2010). Isu dan Cabaran j-QAF dalam Memperkasa Pelajar Islam : Kajian di Sekolah Kebangsaan Datuk Hj Baginda, Melaka. Seminar Pengajian Islam Menjana Keintelektualan Ummah (PIMKU 2010). Universiti Sains Islam Malaysia.
- Mohd Eezan dan Shahlan Surat. (2020). Pemupukan Minat Terhadap Jawi dalam kalangan Murid Sekolah Rendah. *Jurnal Personalia Pelajar*. 23 (2) : 103 – 109. Universiti Kebangsaan Malaysia.
- Mohd Fadhil Nawi dan Abdul Jalil Borhan. (2001). Tahap Penguasaan Tulisan Jawi dan Hubungannya dengan Kemahiran Membaca al-Quran : Satu Kajian di Sekolah Menengah Aminuddin Baki, Johor Bahru, Johor. Tesis Sarjana Muda. Universiti Teknologi Malaysia, Skudai.
- Mohd Majid Konting. (2005). *Kaedah Penyelidikan Pendidikan*. Kuala Lumpur : Dewan Bahasa dan Pustaka.
- Muhammad Fuad Ahmad Tajuddin & Hafizhah Zulkifli. (2022). Faktor-Faktor yang Mempengaruhi Penguasaan Pengetahuan Isi Kandungan(Pik) Bidang Jawi dalam Kalangan Guru Pendidikan Islam [Factors That Influence The Mastery of Knowledge in Jawi Field among Islamic Education Teachers]. *International Journal of Advanced Research in Islamic Studies*
- Naquiah dan Jimain Safar. (2016). Amalan Pengajaran Jawi dalam Pendidikan Masa Kini : Suatu Tinjauan. *Tinta Artikulasi Membina Ummah* 2(2). Muka surat 70-85.
- Nik Rosila Nik Yaacob. (2007). Penguasaan Jawi dan Hubungannya dengan Minat dan Pencapaian Pelajar dalam Pendidikan Islam. *Jurnal Pendidik dan Pendidikan*. Jil. 22, 161-172.
- Norhazliana Mohd Hassan Abdullah, Saedah Siraj, Zaharah Hussin & Norlidah Alias. (2010). Isu kritikal penggunaan tulisan Jawi dalam pelaksanaan kurikulum Pendidikan Islam peringkat sekolah menengah: Pandangan pakar. *Jurnal Pendidikan*, 30, 2010.
- Nur Syamira Abd Wahab, Maimun Aqsha Abdin Lubis & Aisyah Sjahrony. (2016). Aplikasi permainan bahasa bermultimedia ke arah memacu peningkatan kefahaman al-Quran

- dan Jawi. *Asean Comparative Education Research Journal on Islam and Civilization*. 1(1):1-12.
- Rasyidah Ibrahim, Rahimah Embong, Firdaus Khairi Abdul Kadir dan Huda Afiqah Hashim. (2019). *Pemeriksaan Tulisan Jawi Dahulu dan Kini*, BITARA International Studies and Human Sciences 2(1): 29 -37.
- Saiful Bahari bin Abdul Rahman. (2020). *Penguasaan Penulisan Jawi Murid Islam Darjah Enam Sekolah Kebangsaan Seri Duyong Melaka*. Tesis Sarjana. Universiti Kebangsaan Malaysia.
- Saiful Bahri bin Abdul Rahman dan Mazlan bin Ibrahim. (2019). *Tahap dan Faktor yang Mempengaruhi Penguasaan Jawi di kalangan Murid Tahun Enam di Sekolah Kebangsaan Seri Duyong*. Vol. 9, No.11.12.2019. At-Tahkim. *Tazkia University Collage of Islamic Economic*. Universiti Kebangsaan Malaysia.



Aktiviti Kawasan Rukun Tetangga Sebagai Tapak Integrasi

Lina Mastura Jusoh

Fakulti Pengajian Bahasa dan Pembangunan Insan, Universiti Malaysia Kelantan
linamasturajusoh85@gmail.com

Zaleha Embong

Fakulti Pengajian Bahasa dan Pembangunan Insan, Universiti Malaysia Kelantan
zaleha.e@umk.edu.my

ABSTRAK

Malaysia merupakan sebuah negara yang terdiri daripada masyarakat majmuk iaitu Melayu, Cina, India, dan lain-lain. Lazimnya negara yang terdiri daripada masyarakat majmuk sering mengalami konflik. Namun begitu, Malaysia berada dalam keadaan aman dan ketegangan yang stabil. Oleh sebab itu, kerajaan mengambil inisiatif dengan menubuhkan Kawasan Rukun Tetangga (KRT) melalui Jabatan Perpaduan Negara dan Integrasi Nasional (JPNIN) bagi menguruskan masyarakat majmuk. Penubuhan KRT bertujuan untuk memelihara, menambah baik, dan memperkukuh perpaduan rakyat dan integrasi nasional selaras dengan dasar pembangunan negara berlandaskan Perlembagaan Persekutuan dan Rukun Negara. KRT dilihat sebagai agen perdamaian kerana aktiviti yang dianjurkan dapat memupuk semangat kerjasama dan saling membantu dalam masyarakat majmuk. Oleh itu, KRT dianggap sebagai tapak integrasi kerana menjadi titik pertemuan dalam kalangan masyarakat majmuk. Maka, artikel ini bertujuan untuk mengenal pasti peranan KRT sebagai tapak integrasi dalam kalangan masyarakat majmuk di Malaysia. Artikel ini menggunakan kaedah kualitatif iaitu temu bual mendalam dan analisis data menggunakan kaedah tematik. Hasil dapatan mendapati aktiviti yang dijalankan di KRT dapat membina keharmonian dalam kalangan penduduk seperti sambutan kemerdekaan, sukan, bantuan kemanusiaan, aktiviti kanak-kanak, dan Skim Rondaan Sukarela (SRS). Artikel ini menunjukkan bahawa KRT bertindak sebagai tapak integrasi melalui aktiviti-aktiviti kemasyarakatan yang dilakukan apabila menjadi titik pertemuan masyarakat setempat.

Kata Kunci: Kawasan Rukun Tetangga, Tapak Integrasi, Stable Tension, Masyarakat Kepelbagaian, Kesepaduan Sosial.

ABSTRACT

Malaysia is a country composed of plural societies, namely the Malays, Chinese, Indians, and others. Usually, countries that consist of plural societies are often experienced conflict. Nevertheless, Malaysia is in a state of peace and stable tension. For this reason, the government has taken the initiative by establishing Kawasan Rukun Tetangga (KRT) through the Department of National Unity and National Integration (JPNIN) to manage pluralistic communities. The establishment of the KRT aims to preserve, improve, and strengthen the unity of the people and national integration in line with the national development policies based on the Federal Constitution and the Rukun Negara. The KRT is seen as an agent of reconciliation because the activities it organizes can foster the spirit of cooperation and help each other in a pluralistic society. Therefore, KRT is considered a site of integration because it is a meeting point among plural societies. Therefore, this article aims to identify the role of the KRT as a site of integration among plural societies in Malaysia. This article uses qualitative methods, which are in-depth interviews and data analysis using thematic methods. The results found that the activities carried out in KRT can build harmony among residents such as independence celebrations, sports, humanitarian aid, children's activities, and the Skim Rondaan Sukarela

(SRS). This article shows that KRT acts as a site of integration through community activities that are carried out when it becomes a point of contact for the local community

Keywords: Neighbourhood, Site of Integration, Stable Tension, Plural Societies, Social Unity

PENGENALAN

Malaysia merupakan negara yang terdiri daripada masyarakat kepelbagaian dengan keunikan tersendiri. Kepelbagaianya dilihat melalui perbezaan etnik, agama, budaya, bahasa dan lain-lain. Terdapat tiga kaum terbesar di Malaysia iaitu Melayu, Cina, India dan bumiputera lain di Sarawak dan Sabah (Solahuddin Abdul Hamid et al. 2019). Usaha untuk memupuk dan mengukuhkan hubungan antara etnik ke arah perpaduan yang diidamkan sentiasa ditekankan dalam agenda pembangunan negara bangsa Malaysia (PERPADUAN & KITA, 2019; Alatas, 1971). Maka, perlu difahami bagaimana cara membentuk semangat perpaduan dan integrasi antara masyarakat yang mempunyai latar belakang yang pelbagai (Nazri Muslim, Nik Yusri Musa & Ateerah Abdul Razak, 2021).

Masyarakat yang terdiri daripada pelbagai latar belakang sosial sering terdedah kepada konflik. Hal ini boleh menimbulkan isu seperti diskriminasi, pergaduhan, peperangan, penindasan dan sebagainya. Oleh sebab itu, kesepaduan sosial memainkan peranan penting untuk mencapai keharmonian dalam masyarakat majmuk. Malaysia sebuah negara yang terdiri daripada masyarakat majmuk (Zaleha Embong, 2022). Walau bagaimanapun, Malaysia masih dapat mengekalkan kestabilan sosial dan keharmonian walaupun masih berada pada tahap *stable tension* (Shamsul Amri, 2008). Kesepaduan sosial yang dikecapi pada hari ini memerlukan hubungan yang berpaksikan toleransi dan saling menghormati yang akan membentuk rakyat Malaysia yang bersatu padu (Zaleha Embong, 2022)

Antara ciri-ciri tapak integrasi adalah berkaitan dengan satu ruang sosial sama ada abstrak dan nyata. Hal ini juga menjadi titik pertemuan antara pelbagai kelompok dan berlaku prinsip tawar-menawar (*bargaining*), perundingan (*negotiation*) dan pengantaraan (*mediation*). Selain itu, tapak integrasi juga terhasil daripada perbincangan mengikut acuan Perlembagaan Persekutuan yang menghasilkan perpaduan dalam kalangan rakyat Malaysia (Nazri Muslim, Nik Yusri Musa & Ateerah Abdul Razak dlm. Nur Azuki Yusuff, 2021).

KAWASAN RUKUN TETANGGA

Pada 1975, Kawasan Rukun Tetangga (KRT) telah dilancarkan dengan matlamat khusus untuk menjaga keselamatan dan memupuk perpaduan etnik di peringkat akar umbi masyarakat. KRT merupakan salah satu inisiatif kerajaan melalui Jabatan Perpaduan Negara dan Integrasi Nasional (JPNIN) untuk mengadakan program bagi mengurus masyarakat majmuk (JPNIN, 2013). Penubuhan KRT merupakan suatu langkah yang membolehkan rakyat mengawal dan menjaga keselamatan kediaman mereka ekoran beberapa kejadian yang mengancam keselamatan negara pada awalnya. Kawasan-kawasan perumahan yang melaksanakan program SRT dipanggil Kawasan Rukun Tetangga (KRT). KRT merujuk kepada kawasan-kawasan perumahan yang melaksanakan skim ini (Zaleha Embong et al., 2020).

Zaleha Embong et al. (2020) juga menyatakan bahawa KRT yang dilaksanakan sejak tahun 1975 sehingga kini didapati memberi kesan yang baik kepada masyarakat. Malah hubungan antara penduduk semakin baik dengan adanya KRT di suatu kawasan. Walaupun terdapat hubungan penduduk di sesuatu tempat tanpa penubuhan KRT, tetapi penubuhan KRT menjadi suatu mekanisme bagi mengekalkan hubungan dalam aktiviti yang sedia ada. Menurut

JPNIN (2022), konsep KRT mengalami fasa perubahan selaras dengan peredaran semasa sosio ekonomi negara seperti konsep keselamatan, kejiranan, pembangunan komuniti dan model transformasi Rukun Tetangga.

KRT berperanan sebagai agen pendamai kerana aktiviti-aktiviti yang dianjurkan dapat memupuk semangat kerjasama dan saling membantu dalam masyarakat majmuk (Afriva Khaidir, 2010). Penubuhan KRT diberi keutamaan di kawasan-kawasan bandar, pinggir bandar dan kawasan yang berisiko tinggi (JPNIN, 2012). Kawasan-kawasan perumahan yang ingin membuat permohonan untuk menubuhkan KRT perlu mempunyai sekurang-kurangnya 5000 ahli penduduk di kawasan tersebut. Penetapan KRT dilakukan oleh ketua pengarah JPNIN seperti yang termaktub dalam Seksyen 5, Akta Rukun Tetangga 2012 (Akta 751) (Kerajaan Malaysia, 2012).

KRT merupakan sebuah organisasi sosial yang bertujuan mengurus masyarakat setempat dari peringkat akar umbi. Menurut Basri Ibrahim (2001), masyarakat memerlukan sesebuah organisasi yang teratur bagi mencapai matlamat tertentu. Pergerakan yang teratur di bawah satu organisasi yang tersusun rapi dan sistematik adalah penting dalam menjayakan perancangan yang telah diatur. Organisasi jawatankuasa KRT terdiri daripada seorang Pengerusi dan Timbalan Pengerusi, seorang Bendahari dan Setiausaha serta Penolong Setiausaha bersama sekurang-kurangnya dua puluh anggota KRT. Di bawah Kelompok Komuniti pula terdapat Jiran Wanita, Jiran Muda, Tunas Jiran dan Jiran Usia (JPNIN, 2022).

Jiran Wanita merupakan salah satu cawangan di bawah Jawatankuasa KRT yang bertanggungjawab menjalankan aktiviti khususnya bagi Wanita di KRT. Jiran Muda pula ditubuhkan untuk menarik golongan muda terlibat dalam aktiviti kejiranan dan pembangunan komuniti disamping mewujudkan interaksi di antara rakan sebaya dan komuniti setempat. Manakala Tunas Jiran pula terdiri daripada kanak-kanak peringkat TABIKA sehingga sekolah rendah yang terlibat dengan aktiviti yang bersesuaian. Selain itu, Jiran Usia Emas pula merupakan golongan berusia yang menjalankan aktiviti kejiranan yang memberikan peluang kepada mereka untuk menyumbang khidmat bakti kepada masyarakat.

Program KRT sebenarnya hampir sama dengan konsep program Neighbourhood Watch di United Kingdom dan Tonarigumi di Jepun. Program ini bertujuan menggalakkan penyertaan masyarakat untuk mewujudkan perpaduan dan memerangi jenayah serta keganasan di kawasan kejiranan secara kolektif (Neighbourhood Watch London, 2009). Berdasarkan Seksyen 7, Akta Rukun Tetangga 2012 (Akta 751), masyarakat KRT akan mengadakan mesyuarat untuk melantik AJK dalam kalangan penduduk tetap atau pemastautin di kawasan tersebut. AJK yang dilantik ditugaskan untuk mentadbir dan merancang pelbagai aktiviti untuk meningkatkan perpaduan dalam masyarakat majmuk.

TAPAK INTEGRASI

Integrasi dalam masyarakat khususnya terdiri daripada masyarakat majmuk menjadi agenda penting dalam menyampaikan mesej perpaduan dan kedamaian manusia khususnya di Malaysia yang mempunyai masyarakat berbilang etnik (Abang Mohd Razif Abang Muis et al., 2021). Integrasi di Malaysia merupakan suatu proses berterusan bagi mewujudkan satu identiti kebangsaan dalam kalangan masyarakat majmuk dan terpisah daripada aspek budaya, agama, sosial dan kawasan penempatan. Hal ini dipupuk menerusi integrasi politik, sosial, ekonomi, kebudayaan, pendidikan dan wilayah (Baharuddin, 2012; Ramli, 2015). Walau bagaimanapun, proses ke arah mencapai sebuah masyarakat yang berintegrasi bukan suatu perkara yang mudah

dan mampu dicapai dalam tempoh yang singkat kerana integrasi merupakan suatu perkara yang kompleks (Muhammad Safuan et al, 2017).

Secara umumnya, tapak integrasi didefinisikan sebagai satu ruang abstrak dan fizikal yang menemukan pelbagai pihak berkepentingan untuk bersama-sama mencari penyelesaian. Tapak integrasi ialah medium yang dinamik bagi menguruskan pertelingkahan dan perselisihan faham yang wujud dalam komuniti. Usaha penyatupaduan masyarakat memerlukan pembinaan dan pengukuhan tapak integrasi secara berterusan (JPNIN, 2021). Kartini Aboo Talib@Khalid & Shamsul Amri (2020) pula mendefinisikan tapak integrasi sebagai titik pertemuan yang menghubungkan ruang-ruang yang terpisah kepada suatu bentuk perkongsian bersama sebuah ruang sosial yang abstrak kepada bentuk fizikal yang melibatkan individu, keluarga dan komuniti dalam masyarakat.

Menurut Shamsul Amri (2008), KRT dtubuhkan untuk memelihara, meningkatkan dan mengukuhkan perpaduan rakyat dan integrasi nasional selaras dengan dasar-dasar pembangunan negara berlandaskan Perlembagaan Persekutuan dan Rukun Negara. Hal ini jelas dilihat berdasarkan peranan yang dimainkan oleh RT sejak penubuhannya hingga kini, peranan KRT tetap sama dalam konteks meningkatkan dan mengukuhkan perpaduan rakyat walaupun sepanjang penubuhannya berbagai pendekatan diperkenalkan dari pendekatan memelihara keselamatan hinggalah pembangunan komuniti yang menjurus ke arah matlamat perpaduan.

METODOLOGI

Kajian ini menggunakan kaedah kualitatif dengan temu bual secara mendalam. Seterusnya data dianalisis secara tematik. Responden dipilih menggunakan kaedah *purposive sampling* daripada Pengerusi dan Ahli Jawatankuasa (AJK) KRT di Semenanjung Malaysia yang terdiri daripada pelbagai etnik dan latar belakang dari setiap negeri di Malaysia.

HASIL DAPATAN

Temu bual telah dijalankan ke atas Pengerusi dan AJK KRT yang aktif di Semenanjung Malaysia. Dari segi komposisi kaum, kajian ini telah menemu bual Pengerusi KRT kaum Melayu, Cina, India dan Siam.

Berdasarkan hasil temu bual ke atas Pengerusi dan AJK KRT, terdapat beberapa aktiviti telah giat dijalankan dilihat mampu mengeratkan hubungan keharmonian dan kerjasama yang baik antara penduduk KRT. Antaranya ialah:

Gotong-royong

Hasil dapatan kajian mendapati aktiviti gotong-royong merupakan aktiviti utama yang mengeratkan hubungan baik antara penduduk pelbagai kaum di KRT. Kebiasaannya, aktiviti gotong-royong utama bagi masyarakat KRT adalah memberih kawasan perumahan.

Jadual 1: Contoh Gotong-Royong dalam KRT

Subtema	Pernyataan Pengerusi KRT
Gotong-royong	"Kita ada gotong-royong. Kalau kita buat, secondary school pun beri kerjasama bantu bersihkan. (P1)" "Selalunya kita akan buat gotong-royong membersih kawasan perumahan." (P2)

	<p><i>“Kita selalu buat merewang secara bergotong-royong dan membersihkan kawasan kampung.” (P3)</i></p> <p><i>“Biasanya kita ada gotong-royong masak-masak..(P4)”</i></p>
--	----------------------------------------------------------------------------------------------------------------------------------------------------------------------------

Hasil dapatan kajian juga menunjukkan bahawa masyarakat KRT memberi kerjasama dalam aktiviti gotong-royong yang dianjurkan. Selain aktiviti membersihkan kawasan perumahan, acara rewang memasak bagi sesuatu majlis juga sering diadakan di KRT. Walau bagaimanapun bagi segelintir KRT, aktiviti ini semakin kurang mendapat sambutan daripada golongan muda kerana mereka lebih gemar menghabiskan masa lapang dengan aktiviti di luar.

Gotong-royong adalah amalan yang baik dalam memupuk kesepaduan sosial dikalangan penduduk di komuniti kejiranan. Antara aktiviti gotong-royong yang boleh dianjurkan seperti menjaga kebersihan awam seperti masjid, pusat komuniti, pembersihan longkang, pembaikan rumah atau jambatan akibat bencana alam seperti banjir, ribut dan kebakaran. Aktiviti tersebut dapat menyatukan penduduk setempat dengan tujuan baik seperti menjaga kebersihan, melindungi alam sekitar, membantu jiran-jiran dan lain-lain (Mohd Syarifudin Abdullah et al. (2020). Oleh kerana itu, Ibnu Khaldun (1993) berpandangan bahawa toleransi wujud dalam bentuk kerjasama dan keperluan berorganisasi. Hal ini kerana manusia perlu berinteraksi bagi memenuhi keperluan bersama. Lantaran itu, peringkat akomodasi penting agar masyarakat kepelbagaian saling menghormati norma dan nilai kumpulan etnik lain.

Aktiviti Sukan dan Rekreasi

Aktiviti kesukanan merupakan salah satu aktiviti yang mengeratkan hubungan antara penduduk KRT daripada pelbagai kaum. Aktiviti sukan merupakan aktiviti yang paling digemari oleh masyarakat. Oleh sebab itu, pelbagai acara sukan dirangka oleh jawatankuasa KRT bagi menarik minat masyarakat terutama Jiran Muda.

Jadual 2: Contoh Aktiviti Sukan dan Rekreasi

Subtema	Pernyataan Pengerusi KRT
Sukan dan Rekreasi	<p><i>“Sebelum pandemik, kita ada anjur aktiviti bola sepak. Jadi, ramai berbilang kaum join, pekerja asing pun join sekali. I dapat respond yang baik, diorang request suruh I buat lagi tahun depan. Kita ada satu kelab iaitu football club.” (P1)</i></p> <p><i>“Pembukaan gym untuk tarik golongan belia, sebab golongan belia suka pergi”(P2)</i></p> <p><i>“Bulan 11 ni kita ada program besar-besaran hiking (mendaki) bukit Gunung diperingkat Kebangsaan. Program terbuka kepada penduduk Gunung dan terbuka kepada orang luar.” (P3)</i></p>

Aktiviti kesukanan mendapat sambutan yang tinggi daripada penduduk KRT misalnya bola sepak, gym dan mendaki bukit di perkampungan setempat. Aktiviti sukan bukan hanya melibatkan warga tempatan malah turut disertai oleh penduduk warga asing. Manakala pembukaan pusat rekreasi seperti gym adalah bagi menarik golongan belia untuk beriadah.

Dalam hal ini, AJK KRT telah berusaha mencari tajaan untuk mendapatkan dana bagi menampung kos aktiviti yang akan dilaksanakan. Usaha ini menunjukkan sikap tanggungjawab dan kesungguhan AJK KRT dalam menggalakkan Jiran Muda terlibat dalam aktiviti bermanfaat. Aktiviti-aktiviti sukan ini dilihat dapat membina sikap saling menghormati dalam kalangan Jiran Muda. Hal ini seiring bertepatan dengan pandangan Forest (2001) bahawa

hubungan kejiwaan boleh membina kepercayaan dan sikap menghormati khususnya dalam kalangan golongan muda. Che Bakar Che Mat et al. (2007) turut berpandangan bahawa sikap menghormati dapat mewujudkan masyarakat yang Bersatu padu dan harmoni.

Sambutan Perayaan

Sambutan perayaan merupakan aktiviti tahunan KRT yang melibatkan semua kaum saling ziarah-menziarah satu sama lain. Rumah terbuka perayaan menjadi suatu sambutan utama setiap KRT.

Jadual 3: Contoh Sambutan Perayaan

Subtema	Pernyataan Pengerusi KRT
Sambutan Perayaan	<p><i>"Selalunya setiap tahun semua perayaan kita buat.."(P1)</i></p> <p><i>"Semua raya kita buat."(P2)</i></p> <p><i>"Kita buat bantuan makanan perayaan."(P3)</i></p> <p><i>"Biasanya kita buat jamuan raya, semua perayaan kita buat."(P4)</i></p>

Pengerusi KRT menyatakan bahawa perayaan semua kaum diraikan setiap tahun. Hasil dapatan kajian mendapati bahawa sambutan perayaan semua kaum merupakan aktiviti tahunan KRT. Antara aktiviti perayaan yang dilakukan adalah sambutan Hari Hari Raya Aidilfitri, Hari Raya Korban, Tahun Baru Cina, Deepavali dan Krismas. Bagi sambutan perayaan ini, masyarakat KRT turut saling membantu menghulurkan sumbangan kewangan dan barangan keperluan. Malah mereka saling meluang masa bergotong royong menyediakan juadah makanan untuk para tetamu yang hadir. Aktiviti gotong-royong bagi sambutan perayaan mendapat kerjasama yang baik dalam kalangan masyarakat majmuk.

Kepelbagaian aktiviti penduduk dapat dilihat melalui sambutan perayaan samada perayaan untuk etnik Muslim, Hindu, Buddha, Kristian dan sebagainya. Kesemua etnik akan bergotong-royong untuk menyambut perayaan tersebut. Setiap kali musim perayaan, aktiviti kunjung mengunjung akan dilakukan dari rumah ke rumah tanpa mengira etnik dan keturunan (Norfaezah Mohd Hamidin & Hasliza Talib, 2018).

Skim Rondaan Sukarela (SRS)

Konsep rasa 'selamat' dikalangan komuniti merupakan sumbangan utama dalam merangka strategi pencegahan jenayah dan menangani keselamatan awam di Malaysia. Hal ini membantu komuniti memahami dan mengintepretasi masalah harian yang dihadapi dan dilaksanakan melalui keterlibatan secara aktif dalam organisasi sukarelawan keselamatan komuniti sehingga menghasilkan budaya pemerkasaan pencegahan jenayah. Konsep ini dilaksanakan melalui penyertaan secara aktif dalam aktiviti pencegahan jenayah diperingkat komuniti melalui Skim Rondaan Sukarela (SRS) (Norwahidah Zainalibdin & Novel Lyndon, 2016). SRS merupakan antara aktiviti utama pencegahan jenayah dikalangan komuniti KRT di Malaysia. SRS melalui penubuhan Rukun Tetangga telah dipilih sebagai salah satu organisasi sukarelawan keselamatan komuniti yang terlibat dalam Program Transformasi Kerajaan menerusi Inisiatif Mengurangkan Jenayah (NKRA) di bawah Kementerian Dalam Negeri (KDN) dan Program Bandar Selamat di bawah Kementerian Perumahan dan Kerajaan Tempatan (KPKT).

Jadual 4: Contoh Skim Rondaan Sukarela

Subtema	Pernyataan Pengerusi KRT
Skim Rondaan Sukarela	<i>"Biasa ada tiap-tiap tahun, tiap-tiap bulan. kami ada rondaan kawasan..." (P1)</i>

	<p><i>“Kita ada buat rondaan dengan polis. Semua rondaan perlu dilakukan dengan kerjasama polis. So, Jawatankuasa Pembangunan dan Keselamatan Kampung (JPKK) turunkan arahan semua balai polis perlu lakukan rondaan.” (P2)</i></p> <p><i>“Kita ada buat rondaan, adakala AJK wanita pun turut bersama dalam rondaan.” (P3)</i></p>
--	-------------------------------------------------------------------------------------------------------------------------------------------------------------------------------------------------------------------------------------------------------------------------------------------------------------------------------------

Hasil dapatan kajian menunjukkan salah satu acara paling popular yang diadakan secara kerap di KRT ialah program keselamatan yang dilaksanakan melalui SRS. Dalam program ini, terdapat KRT yang menjalankan rondaan dengan kerjasama pihak polis. Selain itu, terdapat juga AJK KRT wanita yang turut terlibat dalam SRS. Hal ini menunjukkan bahawa setiap unit SRS menyumbang kepada keamanan dan keselamatan bagi penduduk yang mendiami kawasan kejiranan (Mohd Syarifudin Abdullah et al., 2020). Sekaligus, Norwahida et al. (2016) mendapati bahawa kadar jenayah telah berjaya dikurangkan dengan mewujudkan projek inovasi pencegahan jenayah oleh komuniti KRT.

Sambutan Hari Kemerdekaan

Sambutan kemerdekaan juga merupakan salah satu aktiviti utama tahunan yang dijalankan oleh KRT di Malaysia. Hasil kajian mendapati KRT menganjurkan sambutan kemerdekaan melalui perarakan, mengibarkan jalur gemilang dan sukaneka serta aktiviti kanak-kanak seperti pertandingan melukis dan mewarna.

Jadual 5: Contoh Sambutan Kemerdekaan dan Hari Kebangsaan

Subtema	Pernyataan Pengerusi KRT
Sambutan Hari Kemerdekaan dan Hari Kebangsaan	<p><i>“Selalunya ada sambutan hari merdeka”. (P1)</i></p> <p><i>“Biasanya kami akan panggil KRT jiran untuk sambutan kemerdekaan memandangkan mereka tiada kemudahan tempat.” (P2)</i></p> <p><i>“Hari kemerdekaan nanti kita ada perarakan terbuka bersama komuniti di sini.” (P3)</i></p> <p><i>“Untuk sambutan kemerdekaan kita juga pertandingan mewarna jalur gemilang dikalangan kanak-kanak.” (P4)</i></p>

Sambutan hari kemerdekaan merupakan aktiviti tahunan bagi semua KRT di Malaysia. Kebiasaannya, KRT yang mempunyai kemudahan dewan aktiviti masyarakat akan bekerjasama dengan KRT jiran yang tidak mempunyai kemudahan prasarana tersebut. Program kemerdekaan dan Hari Kebangsaan wajar terus diadakan bagi memastikan masyarakat kepelbagaian terus bersatu padu. Matlamat utama aktiviti Hari Kemerdekaan adalah untuk meningkatkan rasa cintakan negara dan mengukuhkan semangat patriotic di kalangan masyarakat setempat (JPNIN, 2019).

Kesenian dan Kebudayaan

Aktiviti kesenian dan kebudayaan biasanya dilakukan Ketika meraikan majlis-majlis tertentu seperti hari kebudayaan, kelab seni tari, kedatangan tetamu tujuan lawatan, sambutan perayaan dan sebagainya.

Jadual 6: Contoh Kesenian dan Kebudayaan

Subtema	Pernyataan Pengerusi KRT
Kesenian dan Kebudayaan	<i>“Kat sini petang-petang ada aunty-aunty datang buat senaman menari. Saya pernah buat contest senaman menari untuk semua penduduk area Tangkak untuk tukar-tukar fikiran, cara-cara memahami tarian budaya lain.”(P1). “Kita ada kelas tarian, saya sendiri yang ajar.” (P2)</i>

Hasil dapatan kajian mendapati bahawa dalam aktiviti ini wujud prinsip toleransi apabila masyarakat saling menghormati adat dan kebudayaan etnik lain. Aktiviti ini dilakukan bagi memberi pendedahan serta memperkenalkan tentang kepelbagaian etnik, budaya dan adat kepada masyarakat. Menurut Airen Surayya, Tan, Noor Banu (2021), meskipun setiap kaum mempunyai pegangan dan prinsip yang melambangkan identiti masing-masing, kefahaman pelbagai budaya dan agama telah membantu komuniti ini untuk saling menghormati dan saling bertolak ansur dalam menerima kepelbagaian antara kaum. Oleh sebab itu, Putnam (1993, 1995) berpandangan bahawa penglibatan masyarakat dalam institusi sosial berpotensi membina ruang sosial dan memupuk budaya kerjasama dalam masyarakat kepelbagaian.

PERBINCANGAN

Pelaksanaan aktiviti berfungsi untuk menghubungkan interaksi dan persefahaman dalam kalangan penduduk KRT. Temu bual ini dilakukan terhadap Pengerusi dan AJK KRT tentang aktiviti yang dilaksanakan di KRT yang mengeratkan hubungan dan kerjasama dalam kalangan penduduk KRT. Dapatan kajian mendapati bahawa hubungan antara penduduk semakin bertambah baik dengan adanya aktiviti-aktiviti di KRT. Menurut Ahmad Zainuddin et al. (2016), aktiviti yang dilakukan bersama seperti yang terdapat dalam KRT merupakan satu indikator kepada tahap kesejahteraan penduduk di KRT.

Rajah 1: Aktiviti KRT Sebagai Tapak Integrasi



Kerjasama yang wujud antara penduduk ketika melakukan aktiviti gotong-royong, sukan dan rekreasi, sambutan perayaan, SRS, sambutan hari kemerdekaan dan Hari Kebangsaan serta kesenian dan kebudayaan telah mewujudkan hubungan kerjasama yang baik dalam masyarakat KRT. Selain itu, kesanggupan masyarakat mengorbankan masa merupakan bukti bahawa integrasi wujud di KRT.

Menurut Sanusi (1985), semangat kejiranan sebenarnya wujud, tetapi dalam keadaan tersembunyi. Hal ini dilihat daripada pelbagai aspek seperti kewujudan hubungan baik di kalangan jiran, tidak ada -prasangka antara satu sama lain dan kesediaan membantu jiran-jiran semasa kecemasan.

KESIMPULAN

KRT merupakan mekanisme penting dalam membentuk kesepaduan sosial dalam kalangan masyarakat kepelbagaian di Malaysia. Maka, KRT boleh dianggap sebagai Tapak Integrasi kerana menjadi titik pertemuan dalam melaksanakan pelbagai aktiviti kemasyarakatan. Aktiviti-aktiviti yang dijalankan dilihat telah memupuk sifat saling membantu. Usaha kerajaan dalam menyatupadukan masyarakat melalui pelaksanaan program bersifat meraikan kepelbagaian telah mewujudkan kesepaduan sosial dalam kalangan masyarakat pelbagai latar belakang yang tinggal di KRT di seluruh negara. Maka, kedua-dua aspek kesepaduan sosial dan etos bangsa perlu digerakkan dalam setiap langkah kerajaan dalam memupuk perpaduan diperingkat akar umbi masyarakat, terutamanya menerusi program KRT yang meraikan masyarakat kepelbagaian di Malaysia.

PENGHARGAAN

Artikel ini adalah hasil daripada geran penyelidikan. Jutaan terima kasih ditujukan khas untuk Kementerian Pengajian Tinggi (KPT) yang telah menaja penyelidikan ini dibawah *Fundamental Research Grant Scheme* (FRGS), Grant No: FRGS/1/2020/SS0/UMK/02/3, Fasa 1, bagi tahun 2020.

RUJUKAN

- Alatas, S. H. (1971). Rukunegara. *Pacific Community*, 2(1-4), 800-808.
- Ateerah Abd. Razak, Nur Azuki Yusuff & Zaleha Embong (2021). *Penghayatan Etika dan Peradaban*. Universiti Malaysia Kelantan.
- Basri Ibrahim (2001). *Sistem Pentadbiran dan Organisasi dalam Islam*. Johor Bahru: Perniagaan Jahabersa.
- Ibnu Khaldun (1993). *Mukaddimah Ibn Khaldun* (Ter. Dewan Bahasa dan Pustaka). Kuala Lumpur: Dewan Bahasa dan Pustaka.
- Jabatan Perpaduan Negara dan Integrasi Nasional (PERPADUAN) & Institut Kajian Etnik (KITA), UKM. (2019). *Laporan Akhir Indeks Perpaduan Nasional, 2018*. Jabatan Perpaduan Negara dan Integrasi Nasional.
- Jabatan Perpaduan Negara dan Integrasi Nasional (2022). Diakses pada 10 April 2022 daripada <https://www.jpnn.gov.my/ms/komuniti/rukun-tetangga>
- Mohd Syarieudin Abdullah et al. (2020). Penubuhan Rukun Tetangga (RT) di Malaysia daripada Perspektif Islam. *Tinta Artikulasi Membina Ummah*. 6(1), 99-111.
- Norfaezah Mohd Hamidin & Hasliza Talib (2018). Kesepaduan Sosiobudaya Dalam Kepelbagaian Masyarakat Majmuk. *JAUHAR: JILID 3: BIL. 1*
- Putnam, R. D. (1993). *Making Democracy Work, Civic Traditions in Modern Italy*. Princeton: Princeton University Press.
- Putnam, R. D. (1995). Tuning In, Tuning Out: The Strange Disappearance of Social Capital in Amerika. *PS: Politic Science & Politics*, 28 (4), 664-683.
- Shamsul Amri Baharuddin. (2008). *Modul Hubungan Etnik*. Shah Alam: Pusat Penerbitan Universiti Teknologi Mara.
- Zaleha Embong et al. (2020). *Pengaruh Aktiviti-Aktiviti Ekonomi Dalam Pembangunan Komuniti Terhadap Taraf Sosioekonomi Masyarakat Kawasan Rukun Tetangga di Kelantan*. Skim Geran Penyelidikan Jangka Pendek, Universiti Malaysia Kelantan.

Isu-isu Kesejahteraan Akidah dalam Kalangan Kanak-Kanak Mualaf di Malaysia

Nur Shafiqah Badlihisam

Fakulti Pengajian dan Pengurusan Pertahanan, Universiti Pertahanan Nasional Malaysia
fiqhsamayyah97@gmail.com

Redwan Yasin

Fakulti Pengajian dan Pengurusan Pertahanan, Universiti Pertahanan Nasional Malaysia
redwan@upnm.edu.my

ABSTRAK

Akidah merupakan perkara dasar dalam Islam yang mampu melahirkan keyakinan yang kuat dan teguh dalam menghayati seluruh aspek kehidupan beragama. Hari ini kita melihat pelbagai ancaman akidah yang muncul dalam masyarakat kita terutamanya yang dihadapi oleh golongan kanak-kanak mualaf sehingga boleh mengancam perpaduan masyarakat majmuk di negara ini. Justeru, objektif kertas kerja ini adalah bagi menyorot isu-isu kesejahteraan akidah yang berlaku dalam kalangan kanak-kanak mualaf dan membincangkan masalah sebenar yang wujud di dalamnya. Metodologi kertas kerja ini ialah kajian kualitatif iaitu kaedah dokumentasi dan historis. Ia digunakan bagi menyaring isu-isu kesejahteraan akidah yang berlaku di negara ini. Hasil kajian mendapati bahawa isu-isu akidah yang dihadapi oleh golongan ini merupakan perkara yang telah berlaku sejak sekian lama. Antara isu tersebut ialah isu undang-undang berkait pengislaman golongan kanak-kanak, isu kesejahteraan akidah kanak-kanak mualaf yang tinggal bersama penjaga yang bukan Islam, isu kanak-kanak mualaf ini yang dididik oleh ibu bapa mereka yang turut baru memeluk Islam dan sebagainya. Hal ini amat membimbangkan kerana ia mampu memberi kesan pada kesejahteraan akidah kanak-kanak mualaf tersebut. Justeru, satu usaha bagi menangani isu-isu ini secara efektif perlu dilaksanakan bagi memastikan kesejahteraan akidah kanak-kanak mualaf ini dapat dipelihara.

Kata kunci: *isu, akidah, kanak-kanak, mualaf, ibu bapa*

PENGENALAN

Kanak-kanak menurut Artikel 1 Konvensyen Hak Kanak-Kanak 1989 ialah mereka yang berumur 18 tahun ke bawah kecuali jika undang-undang yang terpakai ke atas kanak-kanak itu menyatakan umur majoriti ialah lebih awal daripada itu. Adapun jika dilihat pada peruntukan undang-undang di Malaysia, Seksyen 2(1) Akta Kanak-Kanak 2001 menyatakan bahawa kanak-kanak ialah mereka yang di bawah umur lapan belas tahun. Di peringkat negeri pula, Seksyen 79 Akta Undang-Undang Keluarga Islam (Wilayah-Wilayah Persekutuan) 1984 memperuntukkan perintah nafkah terhadap anak sehingga anak tersebut mencapai usia 18 tahun tetapi Mahkamah boleh atas sebab yang munasabah untuk melanjutkan perintah nafkah atas anak tersebut, sebagai contoh anak itu akan melanjutkan pelajaran ke peringkat yang lebih tinggi Peruntukan ini juga selari dengan enakmen di negeri Selangor, Kedah dan Terengganu.

Menurut Kamus Dewan Edisi Keempat, “kanak-kanak” ialah budak lelaki atau perempuan yang masih kecil yang tidak melebihi umur 7 atau 8 tahun. Adapun istilah “remaja” pula bermaksud seseorang yang mulai dewasa, sudah akil baligh, dan sudah cukup umur untuk berkahwin. Kesimpulannya, ada persamaan dalam menetapkan had umur kanak-kanak dalam Undang-Undang Antarabangsa dan undang-undang di Malaysia di peringkat persekutuan dan empat negeri iaitu 18 tahun. Had umur ini agak berbeza dengan pandangan Islam yang lebih

konsisten menghubungkan definisi kanak-kanak itu dengan keadaan baligh kanak-kanak tersebut. Walaupun begitu, ada pendapat ulama' yang mengatakan bahawa had umur baligh ialah 18 tahun (Azman Ab. Rahman et al. 2020).

Menurut Azman Ab. Rahman et. al (2015), perkataan mu'alaf berasal daripada kata kerja yang bermaksud melembut dan melunakkan. Seterusnya, Kamus Dewan menyatakan mu'alaf pula bermaksud orang yang baru memeluk Islam atau saudara baru. (Kamus Dewan Edisi keempat, 2010) Terdapat ayat al-Quran yang menyebut secara khusus berkaitan mu'alaf hanya disebut sekali di dalam surah al-Tawbah ayat 60 yang membawa maksud kelompok yang baru memeluk agama Islam. Maksud ayat tersebut ialah: "*Sesungguhnya zakat-zakat itu hanyalah untuk golongan fakir, miskin, pengurus zakat, para mu'alaf yang dipujuk hatinya...*" (Al-Tawbah 9: 60) Ayat ini menjelaskan bahawa zakat yang ditetapkan menjadi hak kepada golongan mu'alaf. Di Malaysia penggunaan perkataan mu'alaf, saudara baru atau saudara Muslim merujuk kepada seseorang yang baru memeluk agama Islam (Mohamad, Abd. Majid, & Omar, 2017). Jakim (2013) menyatakan mu'alaf ialah orang yang baru memeluk Islam sama ada imannya dhaif ataupun imannya sudah kuat dan orang bukan Islam yang cenderung dan boleh dijinakkan hatinya kepada Islam.

Seterusnya, terdapat pelbagai definisi mu'alaf dari sudut istilah fiqh daripada para fuqaha empat mazhab (Azman Ab. Rahman et al. 2020). Menurut Mazhab Syafie, mu'alaf ialah orang yang dilembutkan hatinya dan telah memeluk Islam sahaja. (Al-Shafi'i, t.th: 97). Zakat diberikan kepada golongan ini bagi meneguhkan pegangan Islam mereka. Mu'alaf dari pandangan Mazhab Hanbali pula ialah pemimpin kafir yang mengetuai suatu kaum atau kumpulan yang diharapkan menghentikan kejahatannya serta diharapkan supaya memeluk Islam atau orang Islam yang diharapkan dapat meneguhkan keimanannya dengan pemberian zakat. (Al-Buhuti; 1982: 278) Menurut Akta Pentadbiran Undang-Undang Islam (Wilayah-Wilayah Persekutuan) 1993 iaitu Akta yang mengandungi undang-undang perihal golongan mu'alaf di Kuala Lumpur menyatakan bahawa seseorang itu dianggap sebagai mu'alaf apabila mengucapkan dua kalimah Syahadah dalam bahasa Arab secara semunasabahnya jelas dan sedar bahawa ia bermakna "*Aku naik saksi bahawa tiada tuhan melainkan Allah dan aku naik saksi bahawa Nabi Muhammad S.A.W ialah Pesuruh Allah*" serta pengucapan tersebut mestilah dibuat dengan kerelaan hatinya sendiri.

Menurut Seksyen 95 akta yang sama, terdapat syarat yang wajib dipatuhi oleh golongan yang hendak memeluk Islam iaitu sempurna akal dan mencapai umur 18 tahun ketika hendak memeluk Islam. Adapun bagi yang belum mencapai usia 18 tahun, keizinan daripada ibu atau bapa atau penjaganya adalah diperlukan. Di sebalik itu, terma anak mu'alaf pula merujuk kepada anak-anak dari komuniti yang baru sahaja melakukan pemeluk agama atau baru meyakini agama baru, atau juga baru memeluk Islam. Dalam kata lain, ia membawa maksud anak-anak dari golongan mu'alaf yang baru memeluk Islam dan mempunyai iman dan ilmu pengetahuan Islam yang masih lemah (Hermawansyah & Suryani, 2017).

Berdasarkan kajian yang telah dijalankan oleh Nur Shafiqah et al., (2020) menyatakan kanak-kanak mu'alaf ini ialah kanak-kanak yang berumur 18 tahun ke bawah berdasarkan pada semua perspektif yang telah dinyatakan tadi. Tambahnya, syarak meraikan uruf dan adat setempat yang tidak bercanggah dengan syariat seperti kaedah yang masyhur yang bermaksud "*Adat itu boleh menjadi hukum.*" Justeru, undang-undang yang diwujudkan pada setiap peringkat boleh diambil kira dalam menetapkan had umur kanak-kanak ini (Al-Syatibi, 1996). Adapun bagi maksud mu'alaf, definisi yang diberikan oleh Jakim yang merangkumi golongan Islam dan bukan Islam yang cenderung dan boleh dijinakkan hatinya kepada Islam. Hal ini

kerana definisi ini selari dengan pendapat majoriti ulama' dan manfaat dakwah itu dapat tercapai kepada lebih ramai golongan kerana tidak terhad kepada golongan yang sudah memeluk Islam sahaja.

Umumnya, sebagai seseorang yang baru memeluk Islam pasti sukar dalam mempelajari dan memahami ajaran Islam. Oleh itu, golongan mualaf ini pasti akan mengalami kesukaran dalam mendalami serta mempraktikkan Islam (Ali & Hamjah, 2015). Tuntasnya, bimbingan agama perlu diberikan kepada mualaf untuk memastikan proses pendidikan Islam yang diterima adalah selari dengan ajaran Islam sekali gus mengelakkan dan mengurangkan angka kes murtad dalam kalangan mualaf. Menurut Basir (2012), sebanyak 686 permohonan murtad dicatatkan di Malaysia sepanjang tahun 2000-2010 yang majoritinya ialah golongan mualaf. Hal ini kerana, ilmu pengetahuan agama Islam yang sedikit serta tidak mengamalkan ajaran Islam menjadi faktor utama terjadinya kejadian murtad dalam kalangan mualaf (Tajul Arifin, 2013).

Sangat jelas bahawa kelemahan dalam memahami dan menghayati agama dalam kalangan mualaf akan memudaratkan diri sendiri dan anak-anak mualaf tersebut. Jika ibubapa mualaf murtad, mereka akan turut membawa bersama-sama anak peliharaannya untuk keluar daripada Islam (Abdullah, 2017). Menurut Muhamat @ Kawangit, 2013, Pendidikan Islam bermula dari pengenalan Islam, penghayatan Islam dan akhlak Islam perlu dididik kepada semua golongan mualaf untuk membimbing mereka melaksanakan ajaran Islam dalam hidup mereka, kerana tanpa pendidikan tentang Islam, golongan mualaf akan berdepan pelbagai masalah. Oleh itu, kerana pentingnya pendidikan Islam diajarkan kepada mualaf, sepatutnya tumpuan yang lebih serius perlu diberikan bagi memenuhi keperluan kanak-kanak mualaf bagi mendapatkan bimbingan khusus dalam perkara asas fardhu ain dan pendidikan asas agama Islam yang lain (Abdul Jalil et al., 2017). Namun begitu, pengkaji mendapati kanak-kanak mualaf ini tidak terkecuali daripada berhadapan dengan pelbagai isu yang mencabar kesejahteraan akidah Islam mereka. Oleh itu, kajian ini akan mengenal pasti isu-isu kesejahteraan akidah yang dihadapi oleh kanak-kanak mualaf di Malaysia dalam memperkasakan jati diri Islam dalam diri mereka.

PENGHAYATAN KONSEP AKIDAH ISLAM

Islam amat menitikberatkan soal akidah tauhid yang bebas dari segala bentuk syirik kepada Allah SWT. Maka, misi Nabi Muhammad s.a.w selama 13 tahun di Makkah adalah bagi menanamkan akidah yang kukuh. Akidah ini diumpamakan sebagai sebuah pohon dan di atasnya berdiri syariah Islam sebagaimana firman Allah s.w.t. dalam surah (Ibrahim 14: 24-25) yang bermaksud:

“Tidakkah engkau melihat (wahai Muhammad) bagaimana Allah mengemukakan satu perbandingan, iaitu: kalimah yang baik adalah sebagai sebatang pohon yang baik, yang pangkalnya (akar tunjangnya) tetap teguh, dan cabang pucuknya menjulang ke langit. 25. Dia mengeluarkan buahnya pada tiap-tiap masa dengan izin Tuhannya. Dan Allah mengemukakan perbandingan-perbandingan itu untuk manusia, supaya mereka beringat (mendapat pelajaran).”

Para Ulama' telah memberi definisi akidah dari sudut bahasa dan istilah. Ulama' menyatakan maksud akidah dari sudut bahasa Arab ialah berasal dari perkataan 'aqd yang membawa maksud simpulan, yakin, ikatan dan saling berpegang (Ibn Manzur, t.th: 296). Menurut Sabiq (1984), akidah ialah kepercayaan dan keyakinan yang mantap terhadap sesuatu,

tanpa sebarang rasa syak dan keraguan. Kebanyakan sarjana menetapkan enam rukun iman yang diimani oleh setiap umat Islam itu sebagai maksud akidah yang sah. Allah s.w.t menjadikan iman ini sebagai sesuatu yang sangat berharga dalam diri manusia dan tidak dapat dibandingkan dengan apa jua perkara di dunia ini (al-Sayyid Sabiq 1984: 69). Para ilmuwan Islam bersepakat menyatakan bahawa maksud iman dari sudut bahasa ialah *al-tasdiq* iaitu membenarkan. Adapun penghuraiannya merupakan pengembangan dari konsep *al-tasdiq* itu sendiri.

Selanjutnya, menurut jumhur ulama Ahli *Sunnah Waljamaah*, iman bermaksud membenarkan dengan hati, ikrar dengan lidah dan beramal dengan anggota badan (al-Qudah 1999: 38). Tambah pendapat ini lagi, tahap iman yang perlu ada dalam diri seseorang ialah membenarkan dan berikrar dengan lisan. Sementara itu, takrif yang dinyatakan oleh jumhur ialah bagi menunjukkan tahap kesempurnaan iman seseorang itu. Oleh sebab itu, iman mestilah disertai dengan amal dan sebaliknya. Justeru, amal tanpa iman di dalam hati ialah *nifaq* iaitu seburuk-buruk penyakit hati bagi manusia. Adapun, bagi mereka yang beriman tanpa beramal solih pula merupakan seorang yang *fasiq*. Tuntasnya, iman dan amal soleh ini merupakan kembar rapat yang tidak boleh dipisahkan.

Selain itu, iman yang teguh dalam diri manusia akan terpancar melalui kata-kata dan perbuatan seseorang itu agar dirinya sentiasa bergerak selari dengan syariat Allah s.w.t. Hal ini lahir daripada iman yang teguh terhadap Allah s.w.t, lalu Allah s.w.t menjadikan iman itu terasa indah dalam jiwa mereka. Sesungguhnya, kecintaan mereka terhadap Allah s.w.t dan rasulNya itu melebihi kecintaan mereka terhadap segala perkara yang lain termasuklah diri, harta dan keluarga mereka. Malahan, mereka sanggup berkorban demi Allah s.w.t dan RasulNya ekoran daripada sinaran iman yang menerangi jiwa mereka.

Tambahan lagi, apabila seseorang itu menghayati keimanan dengan ilmu yang benar, mereka akan mampu untuk berjihad di jalan Allah s.w.t walaupun terpaksa meninggalkan dan mengorbankan segala yang dicintai. Seterusnya, jiwa yang teguh keimanannya terhadap Allah s.w.t akan mampu melahirkan persaudaraan yang teguh dan erat. Perkara ini tidak dapat dicapai kecuali melalui asas akidah Islam yang menyatakan dengan jelas bahawa yang paling mulia di sisi Allah s.w.t itu ialah mereka yang paling bertakwa dan bukanlah kemuliaan itu terletak pada bangsa, warna kulit, kekayaan dan sebagainya.

Orang beriman itu akan bersikap lemah lembut, saling mencintai dan saling membantu antara umat Islam. Kendatipun, mereka akan bersikap tegas dengan musuh Islam dan bukanlah sebaliknya. Mereka akan sanggup berkorban walaupun diri sendiri dalam kepayahan kerana akidah itu mengajarkan seseorang itu berjiwa besar dan meletakkan segala pengharapannya kepada semata-mata Allah s.w.t apabila berhadapan dengan segala ujian hidup. Hal ini bersangkutan-paut dengan akidah yang mantap dalam diri mereka untuk hanya berharap kepada Allah s.w.t dalam apa jua keadaan sebagaimana yang telah diajarkan oleh Rasulullah s.a.w. dalam sebuah hadis (HR Tirmizi):

Jagalah Allah, maka engkau akan mendapati-Nya di hadapanmu. Jika engkau memohon (meminta), mohonlah kepada Allah, dan jika engkau meminta pertolongan, mintalah pertolongan kepada Allah.

Sementara itu, akidah yang sejati menjadi punca kebahagiaan hidup seseorang kerana kebahagiaan sejati seseorang itu bukan disebabkan oleh perkara material. Semua itu hanyalah kebahagiaan sementara dan akan hilang maknanya jika tidak mensyukuri segala nikmat

pemberian Allah s.w.t tersebut. Tetapi Allah s.w.t menyatakan dalam surah al-Nahl (16:97) bahawa punca kebahagiaan hidup yang sebenar ialah akidah yang sah.

Terdapat banyak lagi kesan penghayatan akidah Islam dalam hidup manusia yang semestinya membawa kebahagiaan dan kejayaan di dunia dan akhirat. Antara lain ialah akidah juga menjadi asbab melahirkan peribadi yang unggul dan menenangkan jiwa seseorang itu pada perkara-perkara yang menjadi kekusaran seseorang manusia seperti hal rezeki (Mohd Sulaiman Yasin 1985:111). Namun begitu, akidah Islam atau iman ini bersifat naik dan turun. Maka, ia perlu sentiasa dipertingkatkan dengan jalan amal soleh, membersihkan hati, bersahabat dengan orang soleh, menuntut ilmu daripada para Ulama', mempelajari ilmu agama bersumberkan al-Quran dan al-Hadis. memperbanyak zikir, bertaubat dan berselawat ke atas Rasulullah SAW dan mengajak orang lain kepada kebaikan, dan melarang kemungkaran. Di samping itu, istiqamah dalam melakukan amal fardu ain dan fardu kifayah (al-Midani 2007: 615-616).

Isu-Isu Kesejahteraan Akidah Dalam Kalangan Kanak-Kanak Mualaf Di Malaysia

Latar Belakang dan Peranan Ibu Bapa

Mendidik anak dengan pendidikan Islam merupakan tanggungjawab ibu bapa yang tidak boleh dikesampingkan. Namun begitu, ia bukanlah hal yang mudah terutamanya bagi ibu bapa mualaf. Tentu sekali ibu bapa mualaf pada tempoh awal pemeluk Islam, akan mengalami kesukaran dalam mendidik anak-anak dengan ajaran Islam disebabkan ilmu pengetahuan agama mereka yang terbatas. Menurut Mahfud (2017), ibubapa mualaf ini mempunyai ilmu pengetahuan Islam yang kurang dan mereka perlu memiliki pelbagai kaedah dan upaya yang dilaksanakan supaya dapat memberikan pengajaran Islam yang baik dan maksimum untuk anak remajanya. Hermawansyah & Suryani (2017) turut bersetuju dengan kenyataan tersebut dengan menyatakan bahawa ibubapa yang baru memahami tentang agama Islam akan sukar untuk mengajar dan membentuk nilai-nilai Islam dalam diri anak-anaknya. Apatah lagi, ada ibu bapa mualaf yang buta huruf, maka mereka tidak mampu memberikan pendidikan Islam yang sepatutnya kepada kanak-kanak mualaf ini.

Selanjutnya laporan Abdul Rahman (2020), seorang mualaf bernama Muhammad Adam Lai Abdullah menyatakan dia berharap anak-anaknya mendapat pendidikan sehingga peringkat tertinggi bagi memastikan mereka mempunyai masa depan lebih cerah walaupun beliau seorang yang buta huruf. Ia menunjukkan bahawa ibubapa mualaf mahu memberi pendidikan yang terbaik kepada anak-anak mereka tetapi kerana diri mereka sendiri kurang ilmu, maka perkara itu tidak dapat dilaksanakan. Sesungguhnya, kekurangan ilmu dan pemahaman tentang Islam serta masalah buta huruf di kalangan ibu bapa mualaf ini memberi kesan yang negatif kepada kanak-kanak mualaf ini untuk tumbuh sebagai jati diri yang kuat pemahaman dan pegangannya terhadap Islam (Abdullah Nasih Ulwan, 1998).

Apa yang merisaukan ialah kanak-kanak ini cenderung untuk murtad ketika dewasa kelak kerana tiada asas agama yang kukuh dalam diri mereka. Perkara ini turut dipersetujui oleh P.Guleng (2014) yang menyatakan wujud dalam kalangan anak muda mualaf yang gagal menyesuaikan diri dengan masyarakat Muslim di sekitarnya sehingga menyebabkan mereka kecewa dan mengambil keputusan untuk murtad. Oleh sebab itu, sebelum perkara yang lebih buruk itu terjadi, ibubapa mualaf perlu mengambil langkah alternatif dengan mendapatkan bantuan daripada pihak berwajib seperti agensi kerajaan dan bukan kerajaan (NGO) berkaitan untuk memberikan pendidikan Islam kepada anak-anak mereka. Islam amat menitikberatkan soal pendidikan Islam kanak-kanak sehingga mewajibkan golongan pemerintah untuk mengambil alih tugas mendidik kanak-kanak ini jika tiada wali yang layak dan bertanggungjawab untuk memeliharanya (Abdullah Nasih Ulwan, 1998).

Dengan begitu jelaslah bahawa peranan ibu bapa, wali dan pihak berwajib yang berkaitan amat penting bagi mendidik kanak-kanak mualaf ini untuk mempunyai jati diri Islam yang teguh. Perkara ini disokong oleh kajian Siti Nur Isnaini (2019) dan Muftihah (2017) yang mendapati bahawa ada ibu bapa mualaf yang berjaya dalam meningkatkan pemahaman nilai-nilai ajaran Islam kepada anak tetapi ada juga yang belum berjaya. Bagi ibu bapa yang berjaya, rahsianya ialah mereka mempunyai tujuan pendidikan anak yang jelas seperti menginginkan anak berpegang dengan ajaran agama dalam kehidupan mereka serta menjadi hamba Allah yang taat. Manakala ibu bapa yang tidak berjaya, tujuan mereka hanya menginginkan anak tersebut menjadi orang yang baik kepada ibu bapa dan masyarakat sekitar tetapi tidak mengaitkannya dengan tujuan hidup yang diajarkan oleh Islam yang menjadi penentu kejayaan hidup mereka di dunia dan di akhirat (Siti Nur Isnaini, 2019). Tambahan pula, menurut Muftihah, (2017) ibu bapa berperanan untuk menyediakan kemudahan yang berkaitan dengan pendidikan anak, membantu dalam pengurusan waktu anak-anak dan memberikan motivasi agar terus bersemangat untuk menjadi muslim yang terbaik di sisi Allah swt.

Selain itu, terdapat anak mualaf yang tidak dapat hadir ke sekolah akibat daripada latar belakang ibubapa yang bukan warganegara yang mempunyai masalah dokumentasi. Merujuk pada laporan Abdul Rahman (2020), seorang mualaf yang juga merupakan bapa kepada dua orang anak berkata bahawa dia tidak dapat menghantar anaknya ke sekolah sebelum ini kerana masalah dokumentasi kerana isterinya merupakan warganegara Indonesia. Oleh hal yang demikian, hal ini menyebabkan mereka tidak mempelajari pendidikan Islam secara formal yang merupakan subjek teras di sekolah kerana tidak dapat hadir ke sekolah. Suhid et al. (2015) telah menyatakan bahawa Pendidikan Islam merupakan antara mata pelajaran yang wajib diajar sama ada di peringkat sekolah rendah mahupun di sekolah menengah bagi melahirkan individu yang beriman, beramal dan berakhlak soleh.

Isu Kewangan Keluarga Mualaf

Seterusnya, kanak-kanak mualaf ini juga berdepan dengan faktor kewangan. Hal ini disebabkan oleh ibubapa mereka menghadapi kesempitan kewangan setelah memeluk Islam yang menyebabkan mereka tidak dapat memberikan pendidikan agama yang terbaik kepada anak-anak mereka. Sebagaimana yang dinyatakan oleh Yatim (2019), seorang bapa mualaf meluahkan tentang cabarannya dalam membesarkan empat orang anak-anaknya sendiri setelah bercerai dengan isterinya. Bapa mualaf itu menyatakan bahawa beliau memperuntukkan sebanyak RM35 setiap hari untuk perbelanjaan persekolahan bagi kelima-lima anaknya itu selain keperluan perubatan bapanya.

Beliau berkata, *“Setiap hari saya berfikir mengenai sumber kewangan. Tak pernah tak fikir, saya fikir macam mana saya nak dapatkan sumber kewangan tetapi tidak perlu meninggalkan bapa saya seorang diri di rumah”*. Tidak dapat dinafikan lagi, isu kemiskinan dalam kehidupan mualaf boleh memberi kesan terhadap kualiti pendidikan agama begitu juga kewujudannya bagi kanak-kanak mualaf tersebut. Hal ini kerana ibu bapa perlu menggunakan masa yang ada untuk berfikir bagi mencari rezeki dan berusaha untuk mendapatkannya untuk menyara hidup keluarga. Justeru, mereka terpaksa mengkesampingkan soal menuntut ilmu agama di kelas pengajian kerana masa yang ada digunakan untuk mencari rezeki (Prof. Madya Dr. Salasiah Hanin Hamjah, 2021; Kawi & Tan Abdullah @ Tan Ai Pao, 2020).

Sementara itu, terdapat ibubapa mualaf yang hilang sumber rezeki selepas memeluk Islam. Fatimah et al (2018) melaporkan bahawa ada mualaf yang terpaksa berhenti bekerja kerana bidang pekerjaannya sebelum memeluk Islam bertentangan dengan ajaran Islam seperti bekerja di premis-premis arak dan judi. Bahkan, ada yang terpaksa berhenti kerja kerana tidak tahan menerima tekanan dari majikan yang bukan Muslim selepas statusnya sebagai muslim diketahui. Tidak kurang juga ada yang dipecat (Fatimah et al., 2018). Hal ini sejajar dengan

pandangan Mohd Khambali et al. (2017) yang melaporkan bahawa terdapat mualaf yang kehilangan hak bagi menuntut harta pusaka oleh keluarga kandung kerana memilih untuk memeluk Islam.

Namun, syariat Islam yang syumul dan sesuai dengan fitrah manusia di sepanjang zaman, sesekali tidak pernah membelakangkan golongan mualaf ini sendirian. Hal ini jelas dengan pensyariatan pembahagian zakat kepada mereka (Che Abah et al., 2019). Perkara ini dirakamkan di dalam al-Quran menerusi firman Allah SWT dalam surah al-Taubah (9:60): yang bermaksud: “*Sesungguhnya zakat itu hanyalah untuk orang-orang fakir, orang miskin, amil zakat, yang dilunakkan hatinya (mualaf), untuk (memerdekakan) hamba sahaya, untuk (membebaskan) orang yang berutang, untuk jalan Allah dan untuk orang yang sedang dalam perjalanan, sebagai kewajiban dari Allah. Allah Maha Mengetahui, Mahabijaksana.*”

Tambahan lagi, menurut Awang, (2015) sejarah Islam mencatatkan sebahagian daripada harta zakat dan harta rampasan perang diberikan oleh Rasulullah SAW kepada golongan mualaf adalah untuk melembutkan hati mereka. Maka, perkara ini membuktikan bahawa pemberian zakat kepada mualaf yang masih lemah iman ini perlu dilaksanakan sebagai tanda perhatian umat Islam kepada mereka dan bagi meneguhkan hati mereka yang telah melalui pelbagai ujian untuk bergelar muslim dan ujian selepas memeluk Islam.

Oleh yang demikian, Azman et al (2015) mendapati terdapat pelbagai jenis bantuan yang diberikan oleh institusi zakat di setiap negeri kepada asnaf mualaf di bawah Skim Bantuan Asnaf Mualaf menerusi unit Baitulmal Majlis Agama Islam Negeri atau Pusat Zakat Negeri. Bantuan yang diberikan adalah berbeza berdasarkan negeri masing-masing tetapi bertujuan yang sama iaitu menjaga kebajikan golongan mualaf. Malah, ada bantuan pendidikan dan persekolahan yang diberikan oleh hampir kesemua negeri di Malaysia kecuali negeri Kedah, Negeri Sembilan, Pahang, Melaka dan JAWHAR (Azman et al., 2015). Pada waktu yang sama, elaun kehadiran ke kelas bimbingan agama oleh MAIN atau JAIN turut disediakan oleh semua negeri di Malaysia kecuali negeri Sarawak dengan jumlah dan kaedah penyampaian yang berbeza (Azman et al., 2015).

Di Terengganu pula, kelas bimbingan agama dan elaun diberikan kepada semua peringkat umur mualaf sama ada pelajar dewasa, sekolah menengah atau sekolah rendah (*Laman Web Rasmi Majlis Agama Islam dan Adat Melayu Terengganu (MAIDAM)*). Usaha lain yang dilaksanakan oleh pihak MAIN atau JAIN dan NGO juga wajar diberikan pujian dalam membantu golongan mualaf ini menerusi bantuan perlindungan di rumah penempatan sementara, bantuan pendidikan dengan menanggung kos pengajian mualaf di institusi pendidikan terpilih, bantuan alat dan kos perubatan, bantuan perkahwinan dan banyak lagi (Siti Adibah Abu Bakar & Siti Zubaidah Ismail, 2018). Justeru daripada bantuan-bantuan yang disediakan ini dilihat mampu meringkankan beban ibubapa mualaf yang berdepan cabaran kesempitan kewangan dalam memberikan pendidikan Islam kepada anak-anak mereka sehingga boleh menjejaskan masa depan anak tersebut.

Isu Penghayatan Akidah Islam oleh Kanak-Kanak Mualaf

Seterusnya, isu yang dihadapi oleh kanak-kanak mualaf ini dalam pendidikan Islam ialah isu penghayatan agama. Dari sudut bahasa, penghayatan berasal dari perkataan arab iaitu ‘*hayat*’ yang membawa maksud ‘*hidup*.’ Adapun, ‘*menghayati*’ pula ialah kata kerja yang bermaksud mengalami, merasai dalam hati atau meresap ke dalam jiwa (Abd Halim, 2017). Dalam konteks kanak-kanak mualaf pula, ia merujuk kepada penghayatan terhadap konsep akidah Islam itu sendiri sebagaimana yang telah dibincangkan sebelum ini. Perkara ini perlu diberi perhatian yang serius oleh pihak yang berwajib dan semua lapisan masyarakat khususnya ibu bapa kerana kanak-kanak mualaf yang membesar tanpa pegangan akidah yang teguh akan cenderung

murtad ketika dewasa kerana tiada asas jati diri Islam yang dibina sejak dari kecil (Muhammad, Hj. Siren, & Md Yusoff, 2018).

Apatah lagi, ada dalam dalam kalangan ibubapa dan anak-anak hanya menganggap penghayatan Islam ini sekadar pembacaan sebagai rujukan tanpa memerlukan kepada pelaksanaan dan penghayatan yang mendalam (Norddin, 2017). Menurut kajian yang dilaksanakan oleh Muhammad, Hj. Siren, & Md Yusoff (2018), antara punca utama permohonan isytihar murtad dalam kalangan mualaf adalah kerana masalah rumah tangga mualaf yang disebabkan oleh sikap isteri yang curang berpelukan dengan lelaki lain, isteri yang terlalu cemburu menyebabkan suami merasa rimas, suami yang mengabaikan, menganiayai dan bersikap zalim kepada isteri sehingga berlaku perceraian dan mualaf keluar daripada Islam.

Sesungguhnya, kurangnya penghayatan dan didikan agama dalam kalangan rumah tangga mualaf yang menyebabkan keimanannya tercabar dan goyah, lebih-lebih lagi ketika mualaf berdepan kekecewaan. Hal ini selari dengan kajian yang dilakukan oleh Mohd Yusof (2008) yang mendapati bahawa kekecewaan dan masalah yang dihadapi oleh seseorang akan menyebabkan seseorang itu mudah hilang pertimbangan hidup. Perkara ini wajar diberi perhatian kerana kehidupan seseorang manusia itu tidak lari daripada pelbagai ujian yang merenggut ketenangan diri. Tambahan lagi, kanak-kanak yang semakin meningkat dewasa atau remaja kini terdedah dengan dunia luar dan budaya Barat yang memberikan kesan kepada golongan ini dalam memahami agama. Pengaruh luar yang bertentangan dengan Islam ini memberi kesan kepada tingkah laku, akhlak, psikologi dan kepercayaan remaja.

Apatah lagi terdapat agenda asing yang cuba memesongkan akidah umat Islam (Siti Zubaidah 2010). Apabila perkara ini tidak ditangani dengan menanam fahaman akidah yang teguh dalam diri mereka dengan kaedah yang tepat, semestinya ia akan menjejaskan akidah kanak-kanak mualaf ini kerana gerakan-gerakan ini sedang galak mempengaruhi remaja melalui *Facebook*, *WhatsApp*, *Twitter*, Blog dan media massa lain. Fahaman liberalisme dan ekstremisme, feminisme dan hedonisme contohnya disebarkan melalui media sosial telah memberi kesan buruk terhadap akhlak remaja kita hari ini. Oleh itu, kaedah dakwah yang tepat dan pelbagai diperlukan dalam usaha memberikan kefahaman tentang akidah Islamiah yang benar (Ahmad Munawar et al. 2018). Ia penting bagi membina kekuatan spiritual untuk menghadapi ujian hidup yang mencabar akidah umat Islam khususnya mualaf. (Prof. Madya Dr. Salasiah Hanin Hamjah, 2021).

Dalam pada itu, Kasim, Hamid, & Jemali (2017) menyatakan mualaf juga gagal untuk memahami isu-isu berkait salah faham terhadap Islam seperti hak asasi manusia, penindasan perempuan, jumud, kebebasan pemikiran dan sebagainya yang mendorong mereka untuk murtad. Tuntasnya, perkara ini amat berkait dengan tahap kefahaman, keyakinan dan penghayatan mualaf terhadap akidah Islam yang menjadi punca kecemerlangan dan kebahagiaan hidup seorang manusia. Kelemahan penghayatan akidah Islam dalam kalangan mualaf akan menyebabkan kelemahan penghayatan akidah Islam juga berlaku kepada kanak-kanak mualaf ini yang tidak dididik dengan acuan Islam yang sempurna oleh ibu bapa mereka. Jika perkara ini diambil mudah, kanak-kanak itu membesar di atas kesesatan dan ateisme. Malah, jiwanya juga akan bertuhankan hawa nafsu. (Abdullah Nasih Ulwan, 1998). Hal ini akan menjadikan mereka membesar tanpa jati diri Islam yang teguh dan mempunyai kecenderungan untuk murtad ketika telah dewasa, apatah lagi, dengan keadaan cabaran hedonisme dan budaya barat yang rosak akhlaknya telah menghujani pemikiran anak muda kesan daripada perkembangan teknologi internet (Nor Azizah Mustapha, 2019).

Isu Doktrin Struktur Asas di Mahkamah Persekutuan

Selain itu, isu berkait kesejahteraan akidah kanak-kanak Mualaf yang dijaga oleh ibu atau bapa yang bukan Islam yang dikhuatiri amanahnya untuk mendidik kanak-kanak tersebut dengan

ajaran Islam. Hal ini kerana terdapat keputusan kes di mahkamah yang memutuskan hak jagaan kanak-kanak mualaf itu jatuh kepada ibu atau bapa mereka yang bukan Islam setelah pasangan tersebut bercerai sebagaimana yang terjadi dalam keputusan kes Indira Gandhi A.P. Mutho lawan Pengarah Jabatan Agama Islam Perak & sebagainya (Ahmad Johari Mohd Ali, 2022). Kes ini telah dikritik hebat kerana menerima pakai doktrin struktur asas perlembagaan acuan Mahkamah Agung India. Antara yang mengkritik keputusan kes tersebut ialah mantan Ketua Hakim Negara Tun Abdul Hamid.

Doktrin yang cuba diterima dan diperkenalkan Mahkamah Persekutuan sekarang ini mempunyai ciri-ciri seperti prinsip bahawa Perlembagaan negara mempunyai struktur asas yang ditentukan oleh Mahkamah yang tidak boleh dipinda oleh Parlimen. Namun begitu, dua keputusan mahkamah tertinggi negara terdahulu telah menolak doktrin struktur asas perlembagaan acuan Mahkamah Agung India kerana prinsip tersebut bercanggah dengan Perkara 159 Perlembagaan Persekutuan dan telah melampaui bidang kuasa mahkamah. Tun Abdul Hamid menyatakan prinsip struktur asas perlembagaan ini mempunyai struktur asas yang ditentukan oleh Mahkamah yang tidak boleh dipinda oleh Parlimen (Mohd Iskandar Ibrahim, 2022).

Seterusnya, mahkamah mempunyai kuasa bagi menentukan mana-mana undang-undang ataupun pindaan Perlembagaan yang digubal oleh Parlimen sebagai bertentangan dengan struktur asas adalah tidak berperlembagaan dan dianggap sebagai tidak sah. Kesannya, ialah meskipun persetujuan lebih dua pertiga Ahli Parlimen dan perkenan Majlis Raja-Raja telah didapati, mana-mana pindaan Perlembagaan boleh menjadi tidak sah jika ia difikirkan tidak selari dengan struktur asas oleh Mahkamah Parlimen (Mohd Iskandar Ibrahim, 2022). Perkara ini menunjukkan bahawa kuasa mahkamah telah melampaui kuasa badan eksekutif dan perundangan tanpa asas yang jelas kerana doktrin ini tidak tercatat dalam mana-mana undang-undang bertulis di Malaysia kerana ianya hanya berdasarkan penghakiman hakim tersebut. Tambahan lagi, doktrin ini menimbulkan kerisauan umat Islam bahawa Mahkamah Persekutuan boleh menentukan keabsahan sesuatu fatwa, hak muslim dan pengislaman seseorang (Zizi Azlinda Mohd Yusof & Datuk Zainul Rijal Abu Bakar, 2022).

Berbalik pada konteks kanak-kanak mualaf, ia menimbulkan kebimbangan terhadap kesejahteraan akidah kanak-kanak mualaf ini terutamanya bagi yang perlu tinggal dengan keluarga bukan Islam kerana perintah mahkamah berdasarkan prinsip Doktrin Struktur Asas ini yang tidak termaktub kaedah pelaksanaannya dalam mana-mana peruntukan Perlembagaan Malaysia atau undang-undang lain di Malaysia.

Persoalan yang paling membimbangkan ialah bagaimana kanak-kanak tersebut mampu mempertahankan kesejahteraan akidahnya dalam keadaan yang begitu mencabar sekali apabila dijaga oleh ibu bapa yang bukan Islam? Walaupun ada penjaga yang amanah untuk menjaga anak atau cucu mereka yang beragama Islam dengan memastikan mereka mengikuti kelas agama dan melaksanakan solat seperti Tan Guan Neo yang menjaga cucunya yang beragama Islam sejak cucunya berusia 4 bulan (Zikri Abdullah, 2016). Tetapi, kes sebegini tidak menafikan bahawa terdapat cabaran besar terhadap kesejahteraan akidah kanak-kanak tersebut sepertimana yang terjadi dalam kes Indhira Ghandi dan kes-kes yang mungkin boleh berlaku pada masa hadapan.

Isu Kajian mengenai Pengurusan Bimbingan Akidah Islam Kanak-kanak Mualaf

Pengurusan merupakan kata terbitan dari perkataan akar *urus*. Mengurus bermaksud mengendalikan sesuatu supaya teratur (Kamus Dewan Edisi Keempat). Perkataan bimbingan dalam Bahasa Melayu ialah kata nama terbitan daripada kata akar bimbing yang membawa maksud perbuatan membimbing seperti memberi petunjuk, huraian, pimpinan dan sebagainya (Kamus Dewan Edisi Keempat). Perkataan bimbingan juga bersinonim dengan ajaran, latihan,

tarbiah, pelajaran, pendidikan, asuhan dan tunjuk ajar (Zakaria Stapa et. al, 2012). Berdasarkan kajian literatur yang telah dijalankan, masih kurang kajian berkenaan pengurusan bimbingan akidah yang khusus kepada kanak-kanak mualaf. Kajian banyak dijalankan tentang pengurusan bimbingan agama kepada mualaf dewasa (Abdul Jalil & Hamzah Lubis, 2017). Namun begitu, hasil kajian literatur tersebut secara tidak langsung telah memberi idea penambahbaikan pengurusan bimbingan akidah terhadap kanak-kanak mualaf ini.

Sebagai tamsilnya, kajian Nur A'thiroh Masyaa'il Tan Abdullah et al. (2014) yang bertajuk Program Dakwah Islamiah Pertubuhan Kebajikan Islam Malaysia (PERKIM) Kebangsaan kepada saudara muslim: satu tinjauan dari segi pendidikan, mengkaji tentang program dakwah PERKIM kepada mualaf. Dalam konteks kanak-kanak, terdapat Tadika PERKIM Kg Koh dan Tadika PERKIM Pulau Pinang yang menyediakan pendidikan Islam pra persekolahan kepada kanak-kanak Islam dan bukan Islam. Majoriti pelajar di Tadika Kg Koh ialah bukan Islam. Hasil kajian mendapati PERKIM Kebangsaan jelas telah menjalankan dakwah Islamiah dengan baik, sistematik dan berkesan. Tetapi, kajian ini tidak mengkaji secara mendalam tentang pengurusan dan juga bimbingan akidah yang dijalankan itu ke atas kanak-kanak mualaf.

Kajian lain yang mengkaji tentang bagaimana teknologi maklumat boleh menjadi alat bantu mengajar terhadap mualaf. Para guru mendapati integrasi teknologi yang sesuai di dalam pendidikan mualaf adalah berpotensi untuk meningkatkan kecekapan proses pengajaran. Walaupun begitu, kajian ini mendapati bahawa kebanyakan guru mualaf tidak menggunakan teknologi yang ada ketika melaksanakan proses pengajaran dalam bilik darjah sebenar kerana kekangan kemudahan internet dan sebagainya. Tetapi, para guru dan pelajar mengakui bahawa teknologi telah membolehkan tenaga pengajar dan pelajar mengakui bahawa penggunaannya menjadikan proses pembelajaran berlangsung dengan lebih mudah dan efektif (Dr. Tenku Putri Norishah binti Tenku Shariman et al. 2021). Justeru, kaedah ini juga boleh dikaji kepada kanak-kanak mualaf kerana mereka gemar kepada kaedah belajar yang menarik dan diselangi dengan aktiviti-aktiviti yang menarik (Rosni Wazir, 2014).

Kajian mengenai perkara ini perlu diberi perhatian kerana tahap kefahaman dan kaedah bimbingan antara kanak-kanak dan mualaf dewasa adalah berbeza (Noraini Mohamad et.al, 2018). Perkara ini turut dinyatakan oleh Nur A'thiroh Masyaa'il et.al (2015), yang menyatakan tentang kajian oleh Mohamed Fauzi Othman dan Rosman Mohd Yusoff (2008), bahawa pengajaran mualaf dewasa melibatkan proses pembacaan, pemahaman, penerokaan, penyelidikan, perdebatan dan lain-lain. Justeru, perbezaan fizikal dan mental yang jelas antara kanak-kanak dan orang dewasa sepatutnya menyebabkan pendekatan bimbingan akidah yang digunakan adalah sesuai menurut peringkat umur masing-masing. Hal ini kerana setiap peringkat pendidikan akidah memerlukan penggunaan pengetahuan isi kandungan dan rujukan yang sesuai mengikut tahap perkembangan, kematangan, pengetahuan dan usia murid untuk memastikan keberkesanan pendidikan akidah (Abdullah Nasih Ulwan, 1998).

Dari sudut konsep bimbingan akidah yang dijalankan pula, kajian mendapati bahawa para mualaf sukar mempelajari subjek akidah ketika menjalani kursus-kursus yang disediakan. Hal ini kerana, para mualaf sukar memahami subjek akidah kerana ia berkaitan keyakinan seseorang Muslim terhadap Allah SWT dan keyakinan mempercayai perkara ghaib Mariam et al. (2015). Selain itu, beliau juga menyatakan bahawa modul akidah yang diberi di dalam kursus di Selangor adalah sangat padat. Ekoran dari itu, para mualaf sukar memahami keseluruhan pengajaran akidah yang disampaikan di dalam kursus. Selanjutnya, keperluan terhadap modul yang disediakan kepada tenaga pengajar yang merangkumi aspek kemahiran komunikasi, penyediaan silibus dan interaksi perlu dilakukan agar proses pengajaran dan pembelajaran tersebut dapat dijalankan dengan lebih berkesan (Noor Amani Mohamed Hussin et al, 2011). Modul dalam bahasa ibunda mualaf juga dapat membantu mualaf untuk memahami mesej Islam. (Muhamad Zahiri bin Awang Mat & Adnan bin Abd. Rashid, 2021).

Perkara-perkara yang telah disebutkan ini amat penting untuk dinilai kepada kanak-kanak muallaf tetapi masih sedikit kajian yang dibuat khusus untuk mengkaji pengurusan bimbingan akidah kepada mereka.

Isu Psikologi

Perkataan *psychology* merupakan gabungan dua perkataan Greek iaitu *psyche* (psiko) dan *logos*. *Psyche* bermaksud jiwa, rohani, minda dan mental adapun *logos* (logi) pula bermakna kajian (Mahmood Nazar 2001). Maka, perkataan *psychology* membawa maksud kajian tentang jiwa, mental dan rohani manusia. Justeru, dapat difahami bahawa aspek tingkahlaku sentiasa mempunyai hubungan dengan keadaan jiwa dan mental manusia sehingga pakar psikologi secara umumnya mendefinisikan ilmu psikologi sebagai satu kajian yang saintifik tentang jiwa, mental dan tingkahlaku manusia (Mahmood Nazar, 2001). Dalam konteks golongan muallaf m, mereka berdepan pelbagai cabaran psikologi setelah memeluk Islam sama ada ia berpunca daripada dalaman ataupun luaran. Cabaran dalaman ialah cabaran berkisar tentang emosi, hati dan fikiran seperti mempunyai masalah dalam menguruskan stress, kebimbangan dan kemurungan, kurang keyakinan diri serta kerisauan kerana gagal menjadi teladan yang baik kepada orang. Antara cabaran luaran yang sering dihadapi adalah seperti berdepan persepsi negatif daripada masyarakat Islam, mendapat tentangan daripada keluarga serta mengalami masalah kewangan (Prof. Madya Dr. Salasiah Hanin Hamjah, 2021).

Antara cabaran utama yang perlu dihadapi oleh golongan muallaf ialah cabaran luar yang ditimbulkan oleh masyarakat Islam itu sendiri. Terdapat segelintir orang Islam yang tidak menerima dengan baik usaha golongan muallaf untuk mempelajari tentang Islam. Bahkan ada dalam kalangan mereka yang bersikap prejudis terhadap golongan muallaf (Marlon et al. 2014). Sebagai tamsilnya, ada yang beranggapan golongan muallaf menuntut ilmu Islam kerana sekadar ikut-ikutan. Ada juga yang menganggap bahawa muallaf menuntut ilmu-ilmu Islam kerana terpaksa atau disebabkan berkahwin dengan orang Islam. Akhirnya, golongan muallaf terpaksa menelan sahaja tanggapan negatif sesetengah masyarakat Islam itu sehinggalah mereka dapat membuktikan bahawa mereka ikhlas untuk memeluk Islam. Dalam pada itu, ada yang mendapat tentangan daripada ibu bapa dan ahli keluarga dalam menuntut ilmu-ilmu Islam. Ada yang dipulau, dibunuh, dikurung, dipukul dan didera secara fizikal dan mental (Marlon et al. 2014).

Lain daripada itu, ada dalam kalangan muallaf yang terpaksa berdepan dengan masalah kewangan setelah memeluk Islam sebagaimana yang telah disebutkan sebelum ini. (Marlon et al. 2014). Perkara ini selari dengan kajian Nur Najwa Hanani Abd Rahman et al., (2016) yang menjelaskan bahawa di Johor, muallaf menghadapi perubahan dalam hubungan keluarga selepas memeluk Islam terutama dari sudut emosi. Hal ini disebabkan oleh ahli keluarga muallaf merasakan bahawa masuk Islam bermakna menjadi Melayu, memutuskan hubungan keluarga, amalan poligami tidak memberi keadilan kepada wanita, menyebabkan mereka bertindak dengan emosi ketika mengetahui berita bahawa ahli keluarga mereka memeluk Islam. Tambahnya lagi, pelbagai isu lain terpaksa mereka hadapi sama ada dari segi adat dan budaya, kekeluargaan, ekonomi, kerjaya, birokrasi, perundangan dan lain-lain. Isu-isu ini mampu mengesani saudara baharu dengan lebih serius hingga ke peringkat kembali kepada agama asal (murtad) sekiranya ia tidak dibimbing dan ditangani dengan segera oleh pihak berkaitan.

Kanak-kanak muallaf juga turut terjejas emosi mereka jika ibu bapa muallaf berdepan tekanan psikologi. Bahkan mereka mungkin menjadi tempat melepaskan emosi marah dan tertekan oleh ibu bapa. Kesan didera fizikal atau mental akan memberikan kesan negatif kepada kanak-kanak muallaf tersebut dan tidak mustahil mereka akan menyalahkan Islam yang menjadi punca keluarga mereka hidup susah, menderita dan akhirnya menjadi sebab mereka didera. Perkara ini dikhuatiri akan menyebabkan mereka mahu menukar agama ketika telah dewasa

kelak kerana rasa dendam yang didasari salah faham dan kekeliruan ada dalam diri mereka terhadap Islam dan masyarakatnya (Nur Najwa Hanani Abd Rahman et al., 2016). Dalam pada itu, kanak-kanak mualaf yang memeluk Islam kerana pilihannya sendiri, turut berdepan dengan segala cabaran psikologi yang telah dinyatakan tadi.

KESIMPULAN DAN CADANGAN

Berdasarkan kepada hasil kajian yang telah dilakukan, pengkaji mencadangkan semua pihak terutamanya ibubapa, guru-guru yang mengajar anak-anak di pusat-pusat bimbingan saudara baru ataupun di sekolah, bahagian unit dakwah saudara baru, institusi-institusi agama di Malaysia sama ada agensi-agensi kerajaan ataupun bukan kerajaan bahagian Menteri di Jabatan Perdana Menteri (Hal Ehwal Undang-Undang), Jabatan Kehakiman Syariah Malaysia, ahli parlimen bahagian Kementerian Pendidikan Malaysia dan semua pihak yang terlibat supaya bersinergi dalam mengkaji dan menyelesaikan isu-isu kesejahteraan akidah bagi kanak-kanak mualaf ini. Hal ini penting kerana akidah merupakan merupakan perkara asas dalam Islam dan menjadi asbab kecemerlangan di dunia dan di akhirat (Kamal Azmi et al. 2019). Ia penting bagi menjauhkan diri kanak-kanak mualaf ini daripada sebarang ancaman yang mampu merencatkan nilai keagamaan mereka. Apabila akidah mereka telah mantap secara perlahan-lahan mereka akan mula menghayati ajaran Islam melalui ibadah yang dilaksanakan seharian dan bimbingan Islam yang diterima (Mohd Aderi bin Che Noh & Noor bin Azizi Ismail, 2021). Di samping itu, kajian ini menggunakan pendekatan kajian kepustakaan seluruhnya melalui penelitian tulisan-tulisan dan dokumen yang berkaitan anak mualaf. Justeru, kajian lanjutan pada masa akan datang boleh dijalankan dengan mengaplikasikan kajian lapangan seperti menjalankan temu bual dengan anak-anak mualaf dan guru-guru di mana-mana institusi mualaf di Malaysia.

METODOLOGI

Kajian ini menggunakan kajian kepustakaan melalui penelitian terhadap bahan-bahan literatur yang diperolehi daripada Google Scholar, Mendeley dan sumber jurnal yang lain mengenai kanak-kanak mualaf.

RUJUKAN

- Abdullah Nasih Ulwan. (1998) Pendidikan Anak-Anak Dalam Islam: Jabatan Kemajuan Islam Malaysia: Kuala Lumpur.
- Abdul Rahman, N. Mualaf tabah hadapi dugaan hidup (2020, April 26). *Harian Metro*. Diambil daripada <https://www.hmetro.com.my/mutakhir/2020/04/571501/mualaf-tabah-hadapi-dugaan-hidup>.
- Abdul Jalil, J. binti, Hamzah, M. I., & Lubis, M. A. (2017). Tahap Pengetahuan Dan Amalan Fardhu Ain Anak-Anak Muallaf Sekolah Menengah Di Bahagian Sri Aman Sarawak. *ASEAN Comparative Education Research Journal On Islam And Civilization (ACER-J)*. (1), 107–123
- Ahmad Johari Mohd Ali. (2022, Mac 8). MAIPs mohon sebagai pencelah kes perceraian Siew Hong dan Bekas Suami. *Berita Harian Online*. <https://www.bharian.com.my/berita/kes/2022/03/931722/maips-mohon-sebagai-pencelah-kes-perceraian-siew-hong-dan-bekas-suami> . Bahan diakses pada 13 May 2022.
- Ahmad Munawar Ismail. 2012. Aqidah as a Basis of Social Tolerance: The Malaysian Experience. *International Journal of Islamic Thought* 1:1–7.

- Akta Kanak-Kanak 2001 (Malaysia) (Akta 611)
Akta Pentadbiran Undang-Undang Islam (Wilayah-Wilayah Persekutuan) 1993 (Akta 505)
Akta Undang-Undang Keluarga Islam (Wilayah-Wilayah Persekutuan) 1984
Al-Syatibi, “Al-Muwafaqat Fi Usul al-Syariah,” Vol. 2. Dar al-Ma’rifah, Beirut.
- Awang, A. (2015). *Kajian pengalaman dialog kehidupan masyarakat Cina Muslim Terengganu sebelum dan selepas konversi*. (Tesis PhD). Akademi Pengajian Islam. Universiti Malaya
- Azman, A. R., Azdi, W. R. W. M. F., & Irnawaty, I. R. (2015). Analisis pentafsiran muallaf menurut Islam dan enakmen pentadbiran Agama Islam Negeri di Malaysia. *Jurnal Pengurusan dan Penyelidikan Fatwa*, 6, 9–37.
- Azman, A. R., Irwan, M. S., & Shah, M. D. N. R. (2015). Skim bantuan zakat asnaf muallaf: satu analisis kontemporari di Malaysia. *Jurnal Pengurusan Dan Penyelidikan Fatwa*, 6, 167–191. <https://doi.org/10.12816/0029910>.
- Azman Ab. Rahman, Nur Ain Syafiqah Rahmat, Muhd Faiz Abd. Shakor, Nurul Shazwani Nordin & Mohamad Anwar Zakaria, “Kaedah Pengukuran Penentuan Status Muallaf kepada Mukalaf dalam Konteks Malaysia,” *International Journal of Islamic and Civilizational Studies*, 2020.
- Basir, H. (2012). 686 permohonan murtad direkod. *Sinar Harian*, 8
- Che Abah, N., Suhid, A., & Mohd Fakhruddin, F. (2019). Isu dan cabaran saudara baharu di Malaysia: satu tinjauan awal. *Jurnal AL-ANWAR*, 8(2), 1–13.
- Hamjah, M. D. S. H. Psikologi Pendidikan Muallaf. *ISTEM SLAM*, 117.
- Fatimah, S., Nordin, N., Khadijah, I., & Hajar, M. Y. (2018). Cabaran dan implikasi pengurusan dokumentasi saudara baru. *Prosiding Seminar Antarabangsa al-Quran dalam Masyarakat*, p. 422-431. Kuala Nerus: Universiti Sultan Zainal Abidin.
- Mohd Iskandar Ibrahim. Penggunaan Doktrin BSD Bahaya kepada Asas Perlembagaan. (2022, September 22). *Berita Harian*.
- Mustapha, N. A., Sham, F. M., & Mokhtar, A. I. (2019). Program Dakwah Dalam Memantapkan Akidah Remaja Oleh Institut Pemantapan Dan Perkaderan Akidah Malaysia (IPHAM). *Al-Hikmah*, 11(2), 3-19.
- Hermawansyah, H., & Suryani, S. (2017). Internalisasi nilai-nilai keislaman pada anak-anak para muallaf: sebuah kajian Fenomenologi. *Palapa: Jurnal Studi Keislaman dan Ilmu Pendidikan*, 5(1), 14–42. <https://doi.org/10.36088/palapa.v5i1.34>.
- Gomez, J. (2016). Bekas suami Deepa beri amaran rampas anak jika dibesarkan ikut ajaran Hindu. *The Malaysian Insider* Retrieved from <http://www.theinsiderarchived.com/bahasa/article/bekas-suami-454> Vol. 5, No. 2, (December, 2020) deepa-beri-amaran-rampas-anak-jika-dibesarkan-ikut-ajaran-hindu.
- Kamus Dewan Edisi keempat. (2010). Kuala Lumpur: Dewan Bahasa dan Pustaka.
- Kawi, K., & Tan Abdullah @ Tan Ai Pao, N. A. M. (2020). Isu dan cabaran saudara kita di Jabatan Agama Islam Sarawak [Issues and Challenges Muallaf in the Sarawak. *BITARA International Journal of Civilizational Studies and Human Sciences*, 3(2), 28–43
- Konvensyen Hak Kanak-kanak 1989 Majlis Hak Asasi Manusia Pertubuhan Bangsa-Bangsa Bersatu
- Laman Web Rasmi e-SMAF JAKIM. (2013). *Hukum Menggunakan Peruntukan Asnaf Muallaf Untuk Program Dan Hal Ehwal Yang Berkaitan Dengan Aktiviti Dakwah Kepada Bukan Islam*. Retrieved from <http://e-smaf.islam.gov.my/e-smaf/index.php/main/mainv1/fatwa/pr/12376>. (17 Mac, 2022)
- Laman Web Rasmi Majlis Agama Islam dan Adat Melayu Terengganu (MAIDAM) - Jenis-Jenis Bantuan. (n.d.). Retrieved from <http://www.maidam.gov.my/index.php/en/jenis-jenisbantuan> (June 28, 2020)

- Mahfud, M. H. (2017). *Pendidikan Islam bagi remaja dalam keluarga mualaf (studi kasus di Desa Mayang, Gatak, Sukoharjo tahun 2017)*. (Skripsi Sarjana). Fakultas Ilmu Tarbiyah dan Keguruan. Institut Agama Islam Negeri Surakarta.
- Mahmood Nazar Mohamed. 2001. *Pengantar Psikologi: Satu Pengenalan Asas kepada Jiwa dan Tingkah Laku Manusia*. Kuala Lumpur: Dewan Bahasa dan Pustaka
- Mat Karim, K. N.(2017). Muhajir penjana interaksi dan toleransi beragama saudara baru-Muslim-Non-Muslim. *Jurnal Akademika*, 87(2), 63–76. <https://doi.org/10.17576/akad-2017-8702-05>.
- Marlon P. Guleng, Razaleigh Muhamat@Kawangit & Abu Dardaa Mohamad. 2014. Penyesuaian Diri Mualaf terhadap Masyarakat dalam kalangan Pelajar Institut Dakwah Islamiah PERKIM (IDIP). *Jurnal al-Hikmah*. 6, 78-93.
- Mohd Khambali, K., Awang, A., Sintang, S., Abdul Rahman, N. F., Wan Ramli, W. A., & Muhamat, R. (2013). *Dakwah kepada muallaf*. Fakulti Pengajian Islam, Universiti Kebangsaan Malaysia.
- Nur Najwa Hanani Abd Rahman, Razaleigh Muhamat @ Kawangit, Siti Aishah Yahya & Mohd Sufiean Hassan. 2016. Transformasi Hubungan Kekeluargaan Saudara Kita Dari Sudut Emosi Selepas Memeluk Islam di Johor. *Jurnal Ilmi*, Jilid 6, 2016: 125-148.
- P. Guleng, M., Muhamat@Kawangit, R., & Mohamad, A. D. (2014). Penyesuaian diri mualaf terhadap masyarakat dalam kalangan pelajar Institut Dakwah Islamiah PERKIM (IDIP). *Jurnal Al-Hikmah*, 6(1), 78–93.
- Prof. Dr. Mohd Aderi bin Che Noh et. al (2021) Metode Pengajaran Pendidikan Islam Dalam Kalangan Mualaf. *Prosiding Sistem Pendidikan Islam (Mualaf) di Malaysia*, 80-94. Institut Pengajian Islam dan Dakwah Sabah, Keningau, Sabah.
- Siti Adibah Abu Bakar & Siti Zubaidah Ismail (2018), Pengurusan Mualaf di Malaysia: Kerjasama Dinamik Antara Agensi Kerajaan dan Bukan Kerajaan. *Jurnal Usuluddin* 46 (2) 2018: 97-122. <https://doi.org/10.22452/usuluddin.vol46no2.4>
- Siti Nur Isnaini. (2019). *Peran Orang Tua Muallaf Dalam Meningkatkan Pemahaman Nilai-Nilai Ajaran Islam Kepada Anak Di Desa Samban Jaya Bengkulu Utara*. (Tesis Sarjana) Institut Agama Islam Negeri (Iain) Bengkulu Fakultas Tarbiyah Dan Tadris Prodi Pendidikan Agama Islam (Pai)
- Siti Zubaidah Ismail. 2010. Menangani Ajaran Sesat di kalangan Umat Islam: Perspektif Undang-Undang Dan Pentadbiran. *Jurnal Syariah* 18(2):247–76.
- Suhid, A., Ahmad, A. M., Mohd Sabri, S., & Effendy Mohamad, A. (2015). Pendidikan untuk Semua: Amalannya dalam Sistem Pendidikan Islam di Malaysia. *International Journal of Education and Training (InJET)*, 1(2), 1–7.
- Yatim, N. (2019). Kasih seorang mualaf, setia jaga bapa hidap strok. *Sinar Harian*. Diambil daripada <https://www.sinarharian.com.my/article/40542/EDISI/Terengganu/Kasih-seorang-mualaf-setia-jaga-bapahidap-strok>.
- Zikri Abdullah. Guan Neo Sanggup Basuh Rumah Dengan Air Tanah Ingin Jaga Cucu Muslim. (2016, May 4). Malaysia Dateline.
- Zizi Azlinda Mohd Yusof & Datuk Zainul Rijal Abu Bakar (2022). *Doktrin Struktur Asas mengelirukan gugat kedudukan Mahkamah Syariah*. Retrieved October 17,2022 from bhrencana@bh.com.my

Penglibatan Ibu Bapa di dalam Kebolehan Membaca Al-Quran Anak di Rumah

Karim bin Wahab
Fakulti Pendidikan, Universiti Kebangsaan Malaysia
kpgsemera@gmail.com

Mohd Isa bin Hamzah
Fakulti Pendidikan, Universiti Kebangsaan Malaysia
@ukm.edu.my

ABSTRAK

Penglibatan ibu bapa didalam proses pembelajaran anak-anak semestinya menjadi aspek yang sangat penting. Lantaran itu, artikel ini dijalankan adalah untuk mengetahui hubungan antara penglibatan ibu bapa dari sudut motivasi, masa dan juga peneguhan dengan kebolehan membaca al-Quran anak di rumah. Kajian ini dijalankan melalui kaedah kepustakaan dengan cara mencari maklumat, data dan hujah berkaitan penglibatan ibu bapa di dalam kebolehan membaca al-Quran anak yang dapat dijumpai di dalam buku, jurnal, tesis dan lain-lain. Dapatan kajian mengungkapkan tiga aspek yang penting untuk ditekankan oleh ibu bapa iaitu memberi motivasi atau pujian, komunikasi masa dan memberi peneguhan. Akhir sekali, artikel ini dimohon dapat dimanfaatkan dan menjadi rujukan kepada pengkaji-pengkaji lain tentang penglibatan ibu bapa dari sudut motivasi atau kata pujian, masa dan peneguhan dengan kebolehan membaca al-Quran anak di rumah. Kajian ini diharapkan dapat membantu ibu bapa dan pihak yang berkenaan menyelesaikan masalah anak-anak yang tidak boleh membaca al-Quran bermula dari rumah.

Kata kunci; Penglibatan ibu bapa, kebolehan, membaca, al-Quran, anak

ABSTRACT

Parents involvement is an essential aspect in children's learning process. Therefore, this article was conducted to find out the relationship between parental involvement from the point of view of motivation, time and reinforcement with children's ability to read the Quran at home. This study was conducted through library method by finding information, data and arguments related to parent's involvement in children's ability to read the Quran that can be derived from books, journals, theses and other academic readings. The findings of the study reveal three aspect that are important for parents to emphasize, namely giving motivation or praise, timely communication and giving reinforcement. Finally, this article can be benefited as a reference for other researchers about the involovement of parents from the point of view of motivation or words of praise, time and reinforcement with the ability of children to read the Qurán at home. This study is expected to help parents and concerned parties to solve the problem of children who cannot read the Quran starting at home.

Keyword; Parents involvement, ability, recite al-Quran, children

PENGENALAN

Al-Quran ialah kitab suci umat Islam yang menjadi pegangan hidup seluruhnya. Al-Quran merupakan kitab yang terakhir sekali diturunkan sebagai panduan kepada seluruh manusia. Lantaran itu ia sempurna dan dijamin terpelihara dan mempunyai banyak kelebihan. Justeru, sebagai orang mukmin yang benar-benar cintakan Islam dan sayangkan Iman, sewajarnya kita nendampingi al-Quran sebagai cara hidup. Aktiviti membaca al-Quran seharusnya menjadi prinsip hidup dan rutin harian seorang mukmin yang mengaku cintakan al-Quran. Hakikatnya

masih terdapat lagi isu yang melibatkan kebolehan dalam membaca al-Quran dalam kalangan masyarakat kita khususnya melibatkan anak di sekolah. Hal ini sememangnya sangat membimbangkan kerana anak adalah pewaris masa hadapan. Jika hal ini berlarutan pastinya akan membawa kepada banyak masalah di masa hadapan yang melibatkan gejala sosial dalam kalangan remaja. Pendedahan dan penglibatan ibu bapa di dalam memastikan kebolehan anak membaca al-Quran merupakan aspek yang sangat penting dan harus di ambil berat oleh semua pihak kerana pendidikan anak bermula daripada rumah.

Dalam sistem pembelajaran di sekolah pula, al-Quran telah menjadi suatu komponen yang di utamakan dalam kurikulum Pendidikan Islam di Malaysia. Kurikulum KBSM yang lama sememangnya tidak menjadikan aktiviti Tilawah al-Quran sebagai komponen utama di dalam pentaksirannya. Namun, seiring dengan perkembangan dan perubahan dalam KSSM yang baharu diperkenalkan, aktiviti tilawah al-Quran telah di ambil sebagai komponen penting di dalam pembahagian markah dan gred akhir murid. Aspek tilawah turut menitik beratkan kebolehan dan kemampuan membaca al-Quran murid (Muhammad Zulazizi Mohd Nawi 2021).

Di peringkat sekolah, aktiviti berkaitan pembelajaran al-Quran telah dimulakan kepada murid seawal usia 7 tahun iaitu melalui program J-QAF. Program ini mula dilaksanakan di sekolah rendah kebangsaan secara berperingkat pada tahun 2005. Pelbagai model khas telah dirangka bagi melaksana dan memastikan pengajaran dan pembelajaran al-Quran mencapai sasaran. Antara model khas yang telah dibina dan dilaksanakan ialah seperti Model Enam Bulan Khatam al-Quran. Model ini mensasarkan murid boleh khatam al-Quran setelah melalui proses pembelajaran selama 6 bulan. Beberapa surah ditetapkan sebagai objektif untuk dikhatamkan sepanjang tempoh enam bulan itu. Untuk waktu pembelajaran pula diperuntukkan sebanyak 4 waktu sepanjang tempoh enam bulan tersebut. Setelah berjaya melalui proses enam bulan berikutnya pula waktu akan dikurangkan kepada tiga waktu seminggu bagi tahun satu dan dua waktu seminggu bagi tahun dua hingga tahun enam.

Hakikat yang berlaku dewasa ini, masih terdapatnya keciciran dalam kebolehan dan kemampuan membaca al-Quran dalam kalangan murid. Walaupun pada dasarnya, pelbagai program di peringkat sekolah telah dilaksanakan bertujuan untuk mempertingkatkan kebolehan membaca al-Quran murid. Terdapat masih ada murid yang tidak mampu dalam membaca al-Quran. Kajian oleh (Samsudin 2011) menunjukkan matlamat untuk khatam 100% khatam al-Quran dalam program J-QAF masih belum mencapai objektif. Hal ini kerana masih terdapat murid yang belum mencapai dan menghabiskan sukatan yang sepatutnya. Inilah realiti sebenarnya hakikat yang sedang dihadapi oleh para guru di sekolah. Sememangnya murid masih ramai yang tidak mampu membaca al-Quran dengan baik. Apatah lagi untuk menguasai ilmu makhraj huruf dengan betul serta menyempurnakan hukum tajwid dan bab hukum waqaf dan ibtida'.

Penerapan membaca al-Quran seharusnya telah dilakukan terlebih dahulu di rumah oleh ibu bapa (Norwardatun Mohamed Razali et al. 2021). Menurut (Norhaida Shaarani et al. 2015) ibu bapa adalah pembimbing yang diberikan Amanah oleh Allah untuk membimbing anak-anak. Bahkan mereka adalah insan yang terawal berperanan sebagai pendidik yang menerapkan asas pendidikan dalam diri anak-anak. Pembudayaan bacaan al-Quran turut di bantu oleh peranan yang dimainkan oleh ibu bapa di rumah. Sebagai suatu inisiatif daripada ibu bapa yang menyokong asas yang sepatutnya bermula dari rumah agar kebolehan dan kemampuan anak dalam membaca al-Quran berada dalam keadaan yang memuaskan. Kebolehan dan kemampuan membaca al-Quran sememangnya menjadi sukar dicapai oleh anak-anak

sekiranya tiada sokongan dan penglibatan serta pembudayaan yang dimulakan di rumah oleh ibu bapa. Terdapat kajian yang menyatakan kebanyakan anak-anak yang lemah dalam pembacaan al-Quran adalah datang daripada keluarga yang ibu bapanya tidak menghantar anaknya ke kelas persendirian untuk belajar mengaji atau tidak hadir mendapatkan Kelas Asas Fardu Ain (KAFA). Hal ini menjadi lebih sukar kerana dibimbangi akan berlakunya masalah lain yang timbul kerana kegagalan ibu bapa mengisi keperluan rohani anak-anak. Anak-anak sepatutnya membesar dengan perkembangan yang positif iaitu melalui proses pembelajaran yang seimbang sejak dari awal lagi. Apabila berlakunya kelompangan dari awal, pastinya akan memberi kesan pada tahap yang lain dan seterusnya

Kajian oleh (Norwardatun Mohamed Razali et al. 2021) menunjukkan penguasaan murid sekolah lemah dalam bacaan al-Quran sejak dari sekolah rendah lagi. Bahkan dapatan turut menyatakan murid sekolah menengah tidak mampu membaca al-Quran dengan baik. Kajian ini disokong oleh dapatan daripada Mohd Yakub @Zulkifli bin Haji Mohd Yusoff & Saidi bin Mohd (2008) dalam keupayaan bacaan al-Quran di kalangan pelajar tingkatan empat di beberapa buah sekolah menengah terpilih di negeri Terengganu menunjukkan bahawa masih ramai lagi murid di peringkat sekolah menengah tidak mampu membaca al-Quran dengan baik meskipun mereka ini sudah melalui pembelajaran selama enam tahun di peringkat sekolah rendah. Malah menyedihkan lagi hasil tinjauan menunjukkan seramai 192 orang atau kira-kira 60% daripada 320 orang murid yang dibuat tinjauan adalah dalam kategori buta al-Quran. Dapatan ini pastinya suatu gambaran yang sangat membimbangkan.

Dapatan daripada rumusan penguasaan murid dalam program JQAF untuk murid tahun 5 pada Oktober 2021 bagi Negeri Sarawak menunjukkan masih lagi lemah. Hal ini mendorong Jabatan Pendidikan Negeri Sarawak khususnya Sektor Pendidikan Islam telah mengusahakan satu program susulan iaitu Gerak Gempur Al-Quran (GEGAQ) sebagai usaha untuk memastikan kelangsungan aktiviti membaca al-Quran dalam kalangan murid dapat di teruskan dan ditingkatkan. Program bertujuan untuk membantu murid-murid tahun 6 dan tingkatan 5 yang tercicir dalam bacaan Al-Quran, memastikan semua murid tahun 6 dan tingkatan 5 dapat menguasai bacaan al-Quran sebelum tamat sekolah rendah dan sekolah menengah serta membantu murid tahun 6 mengikuti sukatan pelajaran Model Khatam al-Quran program J-QAF.

Menurut dapatan kajian oleh Masnan Jemali (2005), kebolehan membaca al-Quran oleh pelajar di beberapa buah Sekolah Menengah di Negeri Perak adalah berada pada tahap yang lemah iaitu sebanyak 34.5 peratus. Secara keseluruhannya pelajar mencatatkan kelemahan dalam aspek tidak mampu menyebut makhraj huruf, lemah mengenal tanda-tanda hukum tajwid dengan baik.

Kedadaan ini menggambarkan kebimbangan terhadap generasi kini yang menunjukkan betapa penguasaan dan kebolehan membaca al-Quran masih belum sampai ke tahap yang memuaskan. Hakikat ini bersandarkan kajian-kajian lalu yang telah dilakukan menunjukkan kepada peratus pelajar atau anak yang masih lemah terhadap penguasaan dan kebolehan membaca al-Quran sama ada di peringkat sekolah rendah atau menengah.

Tujuan kajian ini dijalankan adalah untuk mengetahui penglibatan ibu bapa dari aspek motivasi, masa dan peneguhan dalam kebolehan membaca al-Quran anak semasa di rumah. Ini penting untuk mendedahkan masyarakat realiti sebenarnya tahap penglibatan ibubapa didalam memastikan kebolehan membaca al-Quran anak semasa di rumah. Pelajar yang terlibat dalam

kajian adalah seramai 30 orang bersekolah dari daerah tempat tinggal yang sama. Justifikasinya adalah untuk melihat persekitaran yang sama semasa di rumah.

Kebolehan membaca al-Quran bagi setiap yang bergelar muslim adalah suatu tuntutan fardhu ain. Melalui kajian ini akan dapat membantu pihak yang terlibat secara khusus di dalam memastikan kebolehan generasi anak-anak pelapis negara dalam membaca al-Quran dapat di pertingkatkan. Kajian ini dapat memberi panduan kepada bahagian Jabatan Kemajuan Islam Malaysia (JAKIM), Jabatan Agama Islam Negeri (JAIS), Institusi Masjid, sekolah dan pihak berkepentingan dalam menentukan kesesuaian cara pendekatan pengajaran al-Quran dengan tahap dan kemampuan anak-anak.

Hasil dapatan kajian ini juga nanti diharap akan menjadi panduan bagi meningkatkan tahap Kerjasama antara pihak sekolah dan ibu bapa atau masyarakat secara amnya dalam memastikan kebolehan membaca al-Quran dan seterusnya menguasai aspek bacaan bertajwid dalam kalangan anak-anak. Hasil kajian juga dapat memberi ilmu pengetahuan kepada ibu bapa dalam mendidik anak-anak khususnya dalam ilmu agama. Seterusnya dapat membantu untuk melakukan tindakan penambahbaikan dalam proses mendidik dan mengajar al-Quran anak di rumah.

Adalah diharapkan hasil kajian akan dapat dimanfaatkan oleh semua pihak yang terlibat di dalam proses pengajaran dan pembelajaran al-Quran dan kepada pihak-pihak yang berminat untuk mengkaji bidang ini pada masa akan datang.

TUJUAN KAJIAN

Tujuan kajian ini dijalankan adalah untuk mengetahui penglibatan ibu bapa dari aspek motivasi, masa dan peneguhan dalam kebolehan membaca al-Quran anak semasa di rumah.

OBJEKTIF

1. Mengenal pasti hubungan antara penglibatan ibu bapa dengan kebolehan membaca al-Quran anak semasa di rumah
2. Mengenal pasti pengaruh penglibatan ibu bapa terhadap kebolehan membaca al-Quran anak semasa di rumah

PERSOALAN KAJIAN

Kajian ini adalah untuk mengkaji tentang penglibatan ibu bapa terhadap kebolehan anak membaca al-Quran dari aspek masa, motivasi dan peneguhan. Secara spesifiknya kajian ini cuba untuk mencari jawapan kepada beberapa persoalan berikut:

1. Adakah terdapat hubungan di antara penglibatan ibu bapa dengan kebolehan membaca al-Quran anak semasa di rumah?
2. Sejauh manakah pengaruh penglibatan ibu bapa terhadap kebolehan membaca al-Quran anak semasa di rumah?

METODOLOGI KAJIAN

Kajian ini telah menggunakan kaedah penyelidikan kepustakaan yang bertujuan untuk mendapatkan data dan dapatan kajian. Pengkaji telah mendapatkan maklumat melalui pembacaan buku, artikel, tesis dan prosiding. Tambahan itu, pengkaji juga telah mencari jurnal-jurnal dalam talian yang boleh didapati dengan melayari engine carian utama seperti Google

Scholar, ResearchGate, dan Jurnal Dunia Pendidikan. Kata kunci yang digunakan dalam mencari maklumat adalah “penglibatan ibu bapa” “peranan ibu bapa”, “pengaruh ibu bapa”, “pengetahuan ibu bapa dalam akademik anak”. “kebolehan membaca al-Quran”, “program J-Qaf” dan akhir sekali “peranan ibu bapa dalam kebolehan membaca al-Quran anak”. Semua maklumat yang diperolehi akan dinilai terlebih dahulu dari sudut kesesuaian dan keaslian kajian sebelum digunakan oleh pengkaji untuk menulis dalam artikel ini. Seterusnya, bahan dan sumber ini akan dijadikan sumber rujukan utama dalam penghasilan penulisan ilmiah yang bermutu dan mengikut piawaian standard yang telah ditetapkan dalam penulisan akademik.

TINJAUAN LITERATUR

Kebolehan membaca al-Quran anak

Tuntutan untuk membaca al-Quran merupakan suatu yang mesti dan tidak dapat dielakkan. Rasulullah juga menggesa umat Islam agar belajar membaca dan memahami al-Quran. Hal ini kerana al-Quran merupakan kitab suci yang diturunkan Allah untuk manusia jadikan sebagai petunjuk dan ianya bersifat kekal hingga akhir zaman. Sabda Rasulullah s.a.w

“orang yang paling baik dikalangan kamu ialah orang yang mempelajari al-Quran dan mengajarkannya kepada orang lain”

Sesuai dengan taraf al-Quran sebagai mukjizat agung, hendaklah setiap daripada orang Islam mempunyai kemahiran membaca dengan betul dan tepat. Hal ini kerana, al-Quran diturunkan dalam bahasa arab yang fasih dan mempunyai susunan ayat yang indah. Pasti al-Quran bukan lah sebuah buku biasa sahaja kerana membacanya memerlukan kemahiran dalam memenuhi sifat-sifat huruf serta memenuhi segala yang terkandung dalam ilmu tajwid.

Di dalam Pendidikan formal di sekolah, seiring dengan perkembangan kurikulum KSSM, aktiviti pembacaan al-Quran telah di masukkan dalam komponen pemarkahan yang melibatkan keputusan peperiksaan secara total (Lampiran 18, Format Instrumen Peperiksaan SPM mulai 2021 Mata Pelajaran Pendidikan Islam, 1223). Faktor ini menyebabkan aktiviti pembacaan atau tilawah al-Quran menjadi aspek yang harus ditekankan dan diberi penekanan oleh semua calon SPM. Aspek kemampuan dan kebolehan membaca al-Quran dalam kalangan pelajar atau calon SPM telah di ambil kira sebagai komponen penting dalam pemberian grad sebenar. Seterusnya menjadikan aktiviti bacaan dan pembelajaran al-Quran seharusnya menjadi lebih rancak dan bersepadu. Para guru di sekolah dan ibu bapa di rumah seharusnya memandang perkara ini secara holistik seterusnya mencari jalan penyelesaian bersama agar anak-anak mampu untuk membaca al-Quran dengan baik.

Kajian oleh (Paharudin bin Arbain, Misnan bin Jemali, Ibrahim bin Hashim 2018) mendapati murid yang melebihi sukatan atau sudah khatam al-Quran membuktikan mereka ini adalah antara yang mendapat bimbingan secara langsung daripada ibu bapa di rumah. Hal ini sangat bertepatan dengan peranan dan tanggungjawab mengajar al-Quran itu sepatutnya menjadi tugas utama ibu bapa dan tidak wajar diserahkan kepada orang lain. Dapatan kajian ini juga menunjukkan bahawa anak-anak yang mendapat perhatian yang sewajarnya di rumah pasti akan mendapat impak yang sangat positif didalam aspek kemenjadian dan akademik mereka. Begitu lah sebaliknya berlaku, anak-anak yang kurang mendapat perhatian akan terabai dan tercicir daripada mendapat perkembangan yang sepatutnya.

Penglibatan ibu bapa

Ibu bapa memainkan peranan yang sangat penting dan impaknya sangat mempengaruhi kejayaan anak-anak di dalam pelajaran. Hal ini kerana ibu bapa adalah individu yang sentiasa

memberi sokongan dan galakkan sehingga anak-anak timbul minat, bersemangat dan menunjukkan ketekunan dan keyakinan diri di dalam proses pembelajaran. Ibu bapa juga lah yang menentukan pola-pola tingkah laku anak-anak. Dorongan dan penglibatan ibu bapa di dalam menentukan kejayaan anak-anak menjadi faktor yang penting dan sangat mempengaruhi kemenjadian anak. Disiplin, kemesraan hubungan antara ibu bapa dan anak serta hubungan keluarga yang utuh dapat memberi kesan ke atas pembentukan personaliti, motivasi serta pencapaian akademik anak-anak. Oleh itu, penglibatan ibu bapa yang kurang di dalam proses mendidik dan mendorong pembelajaran akan menyebabkan berlakunya keciciran dalam perkembangan akademik anak-anak (Nvellymalay 2011)

Faktor sikap ibu bapa menjadi sebahagian daripada penyumbang kepada kebolehan membaca al-Quran anak. Kajian oleh (Awang et al. 2011) mendapati faktor sikap ibu bapa yang mengutamakan pencapaian akademik dan membelakangkan kebolehan membaca al-Quran anak merupakan penyumbang kebolehpupayaan menguasai pembacaan al-Quran. Ibu bapa akan lebih terkesan sekiranya anak mereka tidak berupaya mendapat banyak A ataupun cemerlang dalam peperiksaan berbanding bangga sekiranya anak mampu membaca al-Quran serta khatam. Amalan tidak menjadikan pembacaan al-Quran sebagai rutin di rumah menyebabkan tahap kebolehan membaca al-Quran semakin membimbangkan.

Ibu bapa sepatutnya mendapat bimbingan dan pendedahan mengenai pendidikan keibubapaan. Tanggungjawab mendidik dan memberi ilmu agama terutama dalam ilmu al-Quran sepatutnya bermula daripada rumah lagi. Pendidikan kekeluargaan ini menjadi benteng dalam mendepani arus perubahan semasa yang sentiasa berdepan dengan pelbagai mehnah dan rencam kehidupan.

PERBINCANGAN

Penglibatan ibu bapa dalam kebolehan membaca al-quran anak

Ibnu Khaldun dalam karya nya berjudul Muqaddimah telah menegaskan berkaitan kepentingan ibu bapa memberikan pembelajaran Al-Quran kepada anak-anak sebagai asas pengajaran yang utama dalam semua dasar pembelajaran. Bahkan di anggap sebagai syiar agama yang akan memantapkan aqidah dan mengukuhkan iman. Ibnu sina pula di dalam kitabnya Siyash menasihatkan ibu bapa supaya memulakan anak dengan pengajaran al-Quran semenjak kecil supaya dapat mengenal akan pentingnya bahasa arab dan memantapkan keimanan. Sementara dalam Kitab Ihya Ulumudin karya oleh Imam al-Ghazali menegaskan supaya ibu bapa mengajarkan anak tentang al-Quran semenjak dari kecil lagi.

Menyedari peri pentingnya penglibatan ibu bapa dalam aspek pendedahan awal ini, seharusnya ibu bapa mempersiapkan diri dengan segala ilmu keibubapaan seperti komunikasi. Ilmu komunikasi antara ibu bapa dan anak sangat perlu dititikberatkan. Ini kerana ilmu komunikasi ini sangat dekat dengan institusi kekeluargaan. Ibu bapa dapat menyelami dan memerhati perkembangan dan kemampuan anak. Ibu bapa mampu mengenal personality dan kebolehan anak-anak melalui komunikasi dan penglibatan yang berkesan. Komunikasi yang berkesan akan memberikan kehangatan dan keseronokkan dalam hubungan kekeluargaan. Ibu bapa akan lebih mudah menjadi contoh tauladan yang dekat dengan anak. Didikan dan dakwah akan jadi lebih efisien kepada sasaran iaitu anak.

Dapatan kajian oleh (Manukaram et al. 2013) mendapati factor penglibatan keluarga sangat penting di dalam pengukuhan dan tingkah laku pembelajaran yang positif di peringkat sekolah rendah. Penyertaan dan gaya sokongan serta gaya asuhan ibu bapa ke arah pencapaian yang cemerlang mampu meningkatkan lagi kebolehan pembelajaran sendiri anak-anak. Suasana pembelajaran di dalam keluarga memberi impak positif kepada perkembangan pembelajaran anak-anak. Ini bermakna usaha untuk memupuk kebolehan dan kemampuan

membaca al-Quran anak-anak, peranan yang di mainkan oleh ibu bapa tidak boleh diabaikan. Ibu bapa harus mengambil inisiatif untuk mendidik anak sejak dari kecil lagi supaya ianya mudah dan terkawal.

Penglibatan dari aspek masa

Menurut kajian PISA 2009 (PISA: Programme for International Student Assessment – Program Pentaksiran Murid Antarabangsa) yang dijalankan oleh OECD, (Organisation for Economic Cooperation dan Development – Pertubuhan untuk Kerjasama Ekonomi dan Pembangunan) menunjukkan bahawa cara bagaimana ibu bapa menggunakan masa bersama anak di rumah mempengaruhi kejayaannya. Ibu bapa merupakan individu yang paling akrab dan mempunyai banyak masa dengan anak-anak selepas tamatnya waktu persekolahan rasmi. Anak-anak akan lebih memahami dan menuruti apa saja kehendak ibu bapa. Penglibatan ibu bapa di dalam kecemerlangan akademik ataupun keupayaan membaca al-Quran pastinya lebih di tuntut kerana merekalah yang akan menentukan pengisian masa anak-anak di rumah. Anak-anak yang di biarkan tanpa di berikan sentuhan masa ataupun peneguhan dan komunikasi yang berkesan akan lebih mudah terdedah kepada isu masalah lain yang akan timbul. Kajian lepas banyak membuktikan kegagalan ibu bapa memberikan perhatian kepada anak-anak menyebabkan berlakunya masalah sosial dalam kalangan remaja.

Kajian oleh (Mohd Sahid et al. 2008) menyatakan, penglibatan ibu bapa yang secara kolektif di dalam membantu anak menyiapkan kerja sekolah menyebabkan anak-anak berasa lebih yakin dan berfokus. Ibu bapa yang meluangkan masa memberikan perhatian kepada tugas dan pembelajaran anak menyebabkan matlamat pendidikan menjadi lebih terarah. Seterusnya menggalakkan perkembangan dan kebolehan kognitif dan pembelajaran faktual. Menurut kajian itu lagi, penglibatan ibu bapa yang sanggup meluangkan masa dan membantu anak-anak menyiapkan tugas pelajaran sekolah seakan memberikan gambaran dan menunjukkan keyakinan kepada anak bahawa menghabiskan masa untuk pelajaran adalah suatu perkara yang berfaedah dan bernilai tinggi. Anak-anak yang mendapat tunjuk ajar secara terus daripada ibu bapa lebih berkeyakinan dan seronok kerana ibu bapa meluangkan masa bersama dalam menyiapkan tugas pelajaran.

Dapatan oleh (Lo & M. Yasin 2022) mengatakan penglibatan ibu bapa yang sangat positif dari sudut komunikasi dan masa sepanjang berlangsungnya pembelajaran di rumah (PDPR) memberikan gambaran yang sangat baik kepada kemajuan pencapaian akademik anak-anak. Hal ini kerana sewaktu berlangsungnya pdpr, segelintir ibu bapa bekerja dari rumah dan banyak meluangkan masa di rumah. Peluang ini memberikan ruang kepada ibu bapa untuk lebih banyak masa berkomunikasi dan berinteraksi dengan anak-anak. Anak-anak akan rasa lebih di awasi sekiranya ibu bapa memberikan perhatian dari segi masa secara langsung. Seterusnya dengan pengawasan ibu bapa dapat memastikan perhatian anak-anak mereka kepada proses pembelajaran lebih terarah dan berfokus.

Penglibatan dari aspek motivasi dan pujian

Ibu bapa merupakan orang yang terpenting di dalam memastikan perkembangan anak-anak berada di dalam landasan yang sepatutnya. Ini kerana mereka adalah orang yang paling dekat dengan anak-anak. Ibu bapa merupakan cerminan yang paling ampuh dan perlakuan mereka sangat mudah dilihat oleh anak-anak. Setiap tingkah laku dan gerak geri ibu bapa akan menjadi ikutan oleh anak-anak. Oleh itu, jika ibu bapa tidak mampu menunjukkan teladan yang baik kepada anak-anak, pastinya akan menyebabkan banyak kebejatan dan masalah lain akan timbul. Seharusnya ibu bapa perlu menyedari bahawa mereka adalah pemberi contoh awal kepada anak-anak. Segala pengajaran dan pengalaman yang anak-anak terima melalui interaksi

ibu bapa bermula sejak hari pertama kelahiran lagi. Pendidikan dan pengalaman ini akan menjadi pegangan awal mereka sebelum mereka keluar berinteraksi dengan individu lain. Kesempurnaan pendidikan yang diterima akan melahirkan anak-anak yang baik serta bertanggungjawab.

Ibu bapa yang kerap memberikan motivasi atau pujian kepada anak-anak akan memberikan impak yang sangat positif kepada jiwa anak-anak. Kata-kata pujian akan membuatkan anak-anak mendengarnya berasa disanjung sehingga dapat juga memberikan motivasi dan menjadikan anak-anak menjadi lebih baik. Pujian berperanan sebagai suatu bentuk motivasi dan mendorong anak-anak untuk sentiasa melakukan tingkah laku yang baik. Bahkan, dengan pujian, anak-anak dapat meningkatkan motivasi dalam meningkatkan aras keyakinan mereka. Sekiranya anak-anak kurang motivasi, tahap keinginan untuk belajar akan menjadi lemah dan kurang menarik. Sehingga itu, sehebat mana pun guru yang mengajar pasti tidak akan membuah kan hasil yang positif.

Pujian atau motivasi dapat meningkatkan estimasi sendiri atau daya keyakinan diri. Dalam aspek pembelajaran al-Quran, ibu bapa yang kerap meluangkan diri dengan memberikan pujian, galakan dan motivasi pastinya akan menyebabkan anak-anak rasa terdorong untuk cepat menguasai dan memperbaiki kualiti dan kemahiran membaca. Anak-anak akan memberikan respon dan tindak balas yang baik seterusnya mewujudkan suasana pembelajaran yang kondusif. Pujian dan galakan motivasi yang berkesan juga dapat membantu anak-anak yang lemah dalam menguasai pembelajaran. Ibu bapa yang menggunakan pujian dan galakan motivasi untuk mengakui usaha, perbuatan atau latihan tubi yang dilakukan akan memberikan keyakinan kepada anak-anak. Meskipun mereka melakukan kesilapan tetapi semangat ingin mencuba menyebabkan mereka terdorong. Pujian dan galakan motivasi seharusnya dilakukan oleh ibu bapa secepat yang mungkin apabila melihat anak yang lemah. Dalam keadaan ini galakan motivasi dan ibu bapa yang terlibat sama dalam usaha mempertingkatkan kebolehan dan kemampuan menyebabkan anak-anak akan rasa terdorong dan dihargai.

Penglibatan daripada aspek peneguhan

Amalan pemberian peneguhan merupakan suatu kaedah yang biasa diberikan oleh guru kepada murid dalam proses mendidik. Menurut kajian oleh (Bajuri et al. 2014), pemberian peneguhan adalah bergantung kepada keadaan atau pun tahap kemampuan seseorang. Dalam konteks pembelajaran membaca al-Quran di rumah, ibu bapa seharusnya memahami kaedah peneguhan yang sesuai dengan anak-anak supaya tindakan yang diambil akan mendatangkan hasil dan kemenjadian yang positif. Ini kerana ibu bapa lah lebih mengenali dan memahami tahap kemampuan anak-anak. Kebiasaan amalan peneguhan di lakukan oleh sekolah atau guru yang mengajar hafazan. Kaedah ini akan di terangkan kepada ibu bapa oleh guru sewaktu perjumpaan awal persekolohan setelah kumpulan di bentuk mengikut tahap pencapaian supaya ibu bapa jelas dan maklum akan tindakan yang diambil. Konsep peneguhan berbentuk ganjaran dan dendaan sangat membantu proses hafalan murid dan menjadi amalan kebiasaan bagi sekolah di Malaysia.

Menurut analisis (Bajuri et al. 2014) lagi, amalan pemberian ganjaran yang biasa di lakukan di Malaysia terdiri daripada tiga aspek iaitu ganjaran positif, ganjaran negatif dan hukuman. Ganjaran positif ialah pemberian suatu rangsangan sebagai respons kepada sesuatu tingkah laku yang ditunjukkan sebelumnya dengan menyebabkan perlakuan itu diulangi atau kebarangkalian ia dilakukan akan diperkuatkan lagi. Ganjaran Negatif ialah pemberian berbentuk rangsangan yang tidak selesa atau menyakitkan sebagai respons kepada sesuatu tingkah laku yang ditunjukkan supaya mendorong berlakunya peningkatan tingkah laku yang dapat mengelak atau mengurangkan keadaan yang tidak selesa atau menyakitkan ke atas diri. Sementara hukuman pula ialah pemberian yang bertindak untuk melemahkan atau

mengurangkan berulangnya tingkah laku yang tidak diingini. Hukuman adalah tindakan negatif yang membawa kepada pengurangan dalam kekerapan berlakunya tingkah laku tidak diingini tersebut.

Dalam konteks penglibatan ibu bapa dalam memastikan kebolehan membaca al-Quran anak, kaedah peneguhan ini sangat praktikal untuk di praktikkan sebagai usaha memastikan anak-anak berusaha sedaya mungkin. Anak-anak akan pastinya sedaya mungkin untuk mencuba kerana penglibatan ibu bapa secara langsung dalam memastikan kebolehan dan peningkatan prestasi mereka dalam aktiviti bacaan al-Quran. Ibu bapa yang selalu dilihat oleh anak-anak adalah sebagai penjaga atau pengasuh di rumah bertukar sebagai peranan menjadi guru apabila ibu bapa mereka terlibat secara langsung dalam aktiviti pembelajaran mereka di rumah. Hal ini kerana persepsi anak berubah kerana melihat penglibatan ibu bapa yang cakna dan mengambil berat. Anak-anak akan mempelajari serba sedikit bahawa ibu bapa mereka juga berperanan menjadi guru di rumah.

KESIMPULAN

Penglibatan ibu bapa dalam memastikan anak-anak mampu menguasai dan membaca al-Quran adalah sangat penting. Hal ini telah banyak dibuktikan melalui kajian lepas. Pengkaji banyak membincangkan keperluan ibu bapa sebagai ejen penyokong kepada usaha meningkatkan kebolehan dan kejayaan anak-anak dalam semua lapangan akademik mahupun sosial. Penglibatan ibu bapa daripada aspek masa, motivasi dan peneguhan pastinya akan memberikan impak yang sangat positif kepada perkembangan anak-anak. Hubungan antara penglibatan ibu bapa dengan perubahan anak-anak dalam pendidikan sudah menjadi perkara yang sangat signifikan. Anak-anak yang membesar dengan mendapat perhatian yang lebih daripada ibu bapa pastinya akan membesar dengan penuh cukup kasih sayang dan lebih mudah mencapai kejayaan dalam akademik. Menurut (Paezah & Faridah 2017) penglibatan ibu bapa dalam aktiviti pembelajaran anak-anak membolehkan anak-anak dapat melihat peranan yang berbeza daripada ibu bapa.

Dengan adanya penglibatan ibu bapa dalam komunikasi yang berkesan, memberikan peneguhan dan juga meluangkan masa yang berkualiti dengan anak-anak dapat memastikan peningkatan terhadap amalan membaca al-Quran anak-anak di rumah. Seterusnya sebagai penyokong kepada hasrat dan matlamat pendidikan negara untuk memastikan anak-anak sifar buta al-Quran dapat direalisasikan.

RUJUKAN

- Awang, A., Che Mat, A. & Yaakub, A.N. 2011. Tahap pembacaan al-quran dalam kalangan pelajar di UiTM Terengganu. *Asean Journal of Teaching & Learning in Higher Education* 3(2): 83–100.
- Bajuri, M.K., Saat, R.M., Sharifah, D. & Adli, H. 2014. Pendekatan Peneguhan Bagi Aktiviti Hafalan Al-Quran Dalam Kalangan Pelajar Di Peringkat Menengah Rendah. *Jurnal Islam Dan Masyarakat Kontemporari Bil. 8 Jun*: 113–135.
- Lo, M. & M. Yasin, R. 2022. Penglibatan Ibu Bapa dan Komuniti serta Hubungannya dengan Motivasi Murid SJKC Sepanjang PdPR. *Malaysian Journal of Social Sciences and Humanities (MJSSH)* 7(4): e001426.
- Manukaram, K., Abdullah, M.N.L.Y. & Hasan, S. 2013. Influence of family factor on primary school children's self-regulated learning. *Malaysian Journal of Learning and Instruction* 10: 179–201.
- Mohd Sahid, M., Mustafa, M. & Ahmad, R. 2008. Penglibatan ibu bapa dalam membantu

- membuat kerja rumah (matematik) dikalangan pelajar tingkatan dua: satu tinjauan di sebuah sekolah menengah di daerah Muar. *Seminar Kebangsaan Pendidikan Sains Dan Matematik* 1–7.
- Muhammad Zulazizi Mohd Nawi, D. 2021. Pembacaan Al-Quran dalam Pendidikan Masa Kini: Satu Tinjauan Umum. *Jurnal Al-Turath* 6(1): 43–55.
- Norhaida Shaarani, Muhammad Firdaus Muhammad Sabri, Nor Rosmawati Abdul Karim, Farah Mohd Shahwahid & Haliyana Tonot. 2015. Mengkaji Hubungan Sokongan Ibubapa Terhadap Prestasi Akademik Pelajar Kolej Universiti Islam Antarabangsa Selangor (Kuis). *Proceeding of the 2nd International Conference on Management and Muamalah*. 2(November): 472–483.
- Norwardatun Mohamed Razali, S., Satu, H. & Awal, T. 2021. Kemahiran Bacaan Al-Quran Secara Bertajwid Di Kalangan Pelajar Sekolah Menengah Harian: Satu Tinjauan Awal (October): 6–7.
- Nvellymalay, S.K.A. 2011. Penglibatan Ibu Bapa India Dalam Pendidikan Anak-Anak : Satu Kajian Perbandingan Di Sekolah Jenis Kebangsaan Tamil Dan Sekolah Kebangsaan Di Daerah.
- Paezah, A.H. & Faridah, Y. 2017. Kepentingan penglibatan ibu bapa dalam aktiviti pembelajaran kanak-kanak di prasekolah. *Persidangan Antarabangsa Sains Sosial Dan Kemanusiaan* (2017): 9.
- Paharudin bin Arbain, Misnan bin Jemali, Ibrahim bin Hashim, A. bin H. 2018. Persepsi Murid Terhadap Pelaksanaan Kaedah Pengajaran Guru Dan Hubungannya Dengan Pencapaian Murid Dalam Tilawah Al-Quran Program J-Qaf. *Angewandte Chemie International Edition*, 6(11), 951–952. 10–27.
- Samsudin, F. 2011. Tahap Pencapaian Murid-Murid Tahun enam dalam Modul Khatam Al-Quran J-QAF Satu Kajian di Sekolah Kebangsaan Daerah Kuala Muda Yan.

Faktor Pengaruh Bahasa Inggeris dalam Pembelajaran Bahasa Mandarin Sebagai Bahasa Asing

Nur Farrah Atiqah Amran
Universiti Islam Antarabangsa Malaysia
nurfarrahatiqah@iium.edu.my

Muhammad Nazirul Mohd Noor
Universiti Islam Antarabangsa Malaysia
nazirul@iium.edu.my

ABSTRAK

One of the much-needed added values in the present day is proficiency in a foreign language. Malaysia Education Blueprint 2013-2015 has highlighted third language learning. According to Halliday's Theory of Language, children become proficient in the language because they need to interact with people in their environment. This means to meet their basic needs; the child will have to interact with the public at an early stage. This phenomenon does not occur in the sample. Therefore, the Malay students who only speak Malay and English will not learn the Mandarin language well. This preliminary study aims to analyse factors that contribute to the influence of English among Malay students while learning the Mandarin language. The sample of the study included 10 Malay students in a public university. The instrument used in this study was a questionnaire. The findings of this study are expected to help academicians in producing high-quality graduates with the ability to speak a third language fluently. On top of that, it will also enhance the university's reputation with outstanding student achievement, thus benefiting national development, especially in international relations.

ABSTRAK

Salah satu nilai tambah yang amat diperlukan pada masa kini ialah penguasaan bahasa asing. Pelan Pembangunan Pendidikan Malaysia 2013-2015 telah mengetengahkan pembelajaran bahasa ketiga. Menurut Teori Bahasa Halliday, kanak-kanak menjadi mahir dalam bahasa kerana mereka perlu berinteraksi dengan orang di persekitaran mereka. Ini bermakna untuk memenuhi keperluan asas mereka, kanak-kanak itu perlu berinteraksi dengan orang ramai pada peringkat awal. Fenomena ini tidak berlaku dalam sampel. Oleh itu, pelajar Melayu yang hanya berbahasa Melayu dan Inggeris tidak akan mempelajari bahasa Mandarin dengan baik. Kajian awal ini bertujuan untuk menganalisis faktor-faktor yang menyumbang kepada pengaruh bahasa Inggeris dalam kalangan pelajar Melayu semasa mempelajari bahasa Mandarin. Sampel kajian melibatkan 10 orang pelajar Melayu di sebuah universiti awam. Instrumen yang digunakan dalam kajian ini ialah soal selidik. Dapatan kajian ini diharapkan dapat membantu ahli akademik dalam melahirkan graduan yang berkualiti tinggi dengan kebolehan bertutur dalam bahasa ketiga dengan fasih. Selain itu, ia juga akan meningkatkan reputasi universiti dengan pencapaian pelajar yang cemerlang, sekali gus memberi manfaat kepada pembangunan negara khususnya dalam hubungan antarabangsa.

Kata Kunci: bahasa Mandarin; pengaruh bahasa Inggeris; bahasa asing; pelajar Melayu

PENDAHULUAN

Perkembangan Bahasa Mandarin dilihat semakin mendapat sambutan dalam kalangan pelajar universiti di peringkat pengajian tinggi. Malahan bahasa Mandarin dilihat mendapat permintaan tinggi khususnya di institusi pengajian tinggi awam dan swasta (Norlida, 2018). Bahasa Mandarin dilihat mempunyai nilai tinggi bagi kebolehpasaran graduan setelah tamat

pengajian kerana keperluan industri terhadap bahasa ini. Hal ini seiring dengan Pelan Pembangunan Pendidikan 2013-2025 (PPPM) yang menekankan aspek pembangunan kemahiran insaniah terutama dalam penguasaan bahasa asing dalam kalangan pelajar. Namun begitu, pelajar dilihat tidak dapat menguasai bahasa Mandarin dengan baik sama ada daripada aspek sebutan, pembacaan, tulisan mahupun pendengaran. Hal ini turut disokong dalam suatu kajian yang dijalankan terhadap pelajar-pelajar yang mengikuti pengajian Bahasa Mandarin di sebuah university awam menunjukkan tahap penguasaan penguasaan Bahasa Mandarin dalam kalangan pelajar dilihat lemah dan tidak memuaskan (Tan, 2011).

Dalam hal ini, penguasaan bahasa Mandarin yang dilihat sebagai bahasa asing sering kali terkait rapat dengan faktor atau pengaruh bahasa kedua terutama bahasa Inggeris. Bahasa Inggeris dilihat merupakan satu bahasa yang penting dikuasai kerana ianya merupakan bahasa utama di peringkat dunia (Grenier, 2015). Dalam konteks Pendidikan di Malaysia, bahasa Inggeris dilihat lebih diutamakan berbanding bahasa-bahasa lain. Walaupun PPSMI telah lama dimansuhkan, namun bahasa Inggeris dilihat merupakan bahasa wajib digunakan diperingkat pengajian tinggi (Mamat, 2016). Malah, penggunaan bahasa Inggeris dilihat diguna pakai secara meluas sama ada di pelantar media seperti televisyen, aplikasi telefon pintar dan media social (Mustafa, 2017). Malah pengajaran bahasa Inggeris telah lebih awal diperkenalkan oleh kerajaan dalam usaha meningkatkan pembangunan diri pelajar. Penggunaan bahasa Inggeris secara meluas ini dilihat mampu mempengaruhi tahap penguasaan bahasa asing dalam kalangan mahasiswa terutama bagi bahasa Mandarin.

Justeru, kajian awal ini dilaksanakan untuk mengkaji apakah aspek yang menjadi faktor pengaruh bahasa Inggeris dalam pembelajaran bahasa Mandarin sebagai bahasa asing dalam kalangan pelajar Melayu di peringkat pengajian tinggi.

OBJEKTIF KAJIAN

Objektif kajian ini adalah untuk:

1. Mengenal pasti sama ada media menjadi faktor bahasa Inggeris mempengaruhi pembelajaran bahasa Mandarin sebagai bahasa asing.
2. Mengenal pasti sama ada pengajar menjadi faktor bahasa Inggeris mempengaruhi pembelajaran bahasa Mandarin sebagai bahasa asing.
3. Mengenal pasti sama ada rakan sebaya menjadi faktor bahasa Inggeris mempengaruhi pembelajaran bahasa Mandarin sebagai bahasa asing.

KAJIAN LITERATUR

Dalam mempelajari bahasa asing, pelajar perlulah menguasai kemahiran utama seperti kemahiran membaca, kemahiran bertutur, kemahiran menulis dan kemahiran mendengar. Penguasaan empat kemahiran utama sangat penting bagi mewujudkan pembelajaran yang seimbang dan mencapai objektif yang diinginkan (Darancik, 2018). Dalam konteks pembelajaran hari ini, pelajar boleh menguasai aspek kemahiran bahasa dalam ruang pembelajaran sama ada dalam sesi kelas bersama pengajar atau di luar waktu pembelajaran (Jaafar, 2020).

Menurut Meskill (2002), ciri-ciri pada media yang bersifat berpengaruh terhadap aspek sebutan, sintaksis dan leksikal akan membuatkan penutur mudah untuk mempelajarinya berbanding secara tradisional di dalam ruang kelas pembelajaran. Hal ini turut disokong oleh beberapa pengkaji seperti Haqiqi (2018) dan Imani (2020) yang menyatakan faktor media mempengaruhi tahap penguasaan sesuatu bahasa dengan cepat.

Pun begitu, dalam konteks pembelajaran bahasa Mandarin, penggunaan media yang meluas seperti Youtube, TikTok, Instagram dan Facebook yang keseluruhannya menggunakan tetapan berbahasa Inggeris sudah pasti akan mempengaruhi tahap penguasaan bahasa Mandarin. Hal ini kerana purata generasi muda pada masa kini memperuntukkan purata 11.6 jam sehari untuk sekadar melayari laman-laman media berbanding untuk tujuan pembelajaran (Manap et al., 2016).

Manakala dalam satu kajian yang dijalankan oleh Kito and Hamada (2008), antara lima faktor memotivasikan pelajar dalam penguasaan bahasa asing ialah faktor guru yang. Hal ini turut disokong oleh kajian Adzhar and Radzi (2020) yang menyatakan kualiti guru dan aspek penyampaian penting dalam penguasaan bahasa cina pelajar di sekolah.

Oleh yang demikian, pengkaji mendapati bahawa amat wajar kajian dilakukan untuk mengkaji faktor-faktor pengaruh bahasa Inggeris dalam pembelajaran dan penguasaan bahasa Mandarin sebagai bahasa asing. Meskipun kajian-kajian terdahulu ini telah dijalankan, namun pengkajian dalam aspek pengaruh bahasa kedua terhadap bahasa asing masih kurang dikaji kerana banyak tertumpu terhadap aspek bahasa ibunda sahaja. Sehubungan itu, kajian ini akan dilaksanakan bagi mengkaji faktor pengaruh bahasa Inggeris terhadap pembelajaran bahasa Mandarin sebagai bahasa asing.

METODOLOGI KAJIAN

Teori yang diaplikasikan dalam kajian ini ialah teori Interaksi oleh Halliday. Menurut teori ini, antara aspek yang mempengaruhi pembelajaran bahasa ialah situasi persekitaran dan psikolinguistik. Pelajar perlu mempunyai interaksi dan persekitaran yang membantu serta mendorong mereka untuk mempelajari sesuatu bahasa (Halliday et al., 2014). Halliday menekankan bahawa pengalaman manusia, yakni struktur sosial, memainkan peranan yang sangat penting dalam pemerolehan bahasa kedua (Santoso, 2008).

Responden kajian awal ini terdiri daripada 10 orang pelajar Melayu di sebuah institusi pengajian tinggi awam di Malaysia. Institusi ini menawarkan kursus elektif bahasa Mandarin dan menggunakan bahasa Inggeris sebagai bahasa pengantar utama ketika sesi pengajaran dan pembelajaran. Kriteria responden yang dipilih ialah pelajar Melayu yang tidak pernah bersekolah di Sekolah Jenis Kebangsaan Cina serta sedang mengambil kursus bahasa Mandarin tahap dua.

Kajian ini adalah kajian kuantitatif. Kajian ini menggunakan instrument soal selidik bagi mendapatkan data kajian daripada responden. Borang soal selidik ini mengandungi dua bahagian iaitu bahagian A dan bahagian B. Responden perlu mengisi jantina dan tahap penguasaan bahasa dalam bahagian A, manakala bahagian B pula mengandungi kenyataan berkaitan faktor pengaruh bahasa Inggeris dalam pembelajaran bahasa Mandarin sebagai bahasa asing. Bahagian B menggunakan kaedah skala likert lima peringkat iaitu, Sangat Setuju, Setuju, Tidak Pasti, Tidak Setuju dan Sangat Tidak Setuju. Soal selidik dalam kajian ini telah diubahsuai daripada kajian lepas iaitu kajian Ooi and Subramaniam (2017), Mohammad (2017), Hassan (2021) dan Hassan (2021).

KEPUTUSAN

Sumber data primer digunakan dalam pengumpulan data kajian awal ini. Menurut Yusof (2004) data primer ialah data yang berasal dari sumber asli atau pertama. Data asal dikumpul secara

husus untuk menjawab soalan perkajian Marican (2005). Data daripada instrumen soal selidik ke atas responden merupakan data asal bagi kajian awal ini.

Dapatan Soal Selidik

Dapatan daripada soal selidik adalah seperti di bawah.

Jadual 32. Data Demografi Responden

Demografi	Kategori	Kekerapan	Peratus
Jantina	Lelaki	1	10%
	Perempuan	9	90%

Berdasarkan Jadual 1 di atas, responden kajian awal ini terdiri daripada 1 orang pelajar lelaki (10%) dan 9 orang pelajar perempuan (90%) yang tidak pernah bersekolah di Sekolah Jenis Kebangsaan Cina serta sedang mengambil kursus bahasa Mandarin tahap dua.

Rajah 1. Tahap Penguasaan Bahasa

Tahap Penguasaan Bahasa

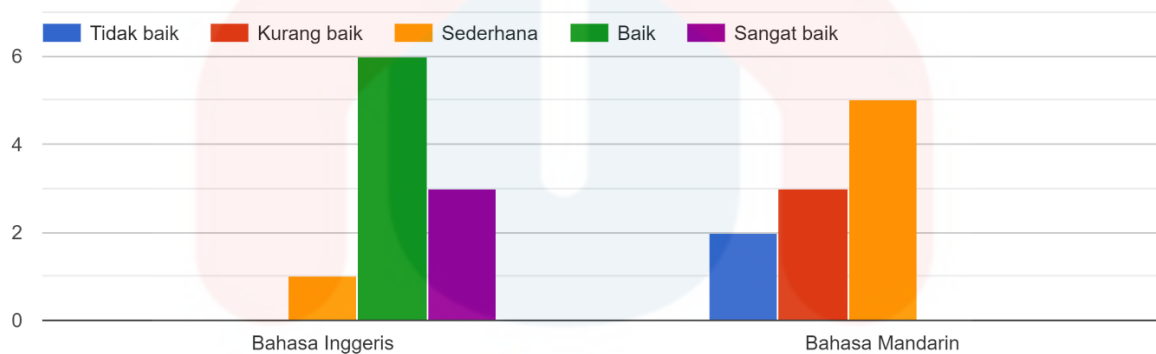

Dari segi tahap penguasaan bahasa, sebanyak 30% (3 orang) memilih Sangat Baik bagi bahasa Inggeris, 60% (6 orang) memilih Baik dan 10% (1 orang) memilih Sederhana. Untuk tahap penguasaan bahasa Mandarin pula, terdapat 50% (5 orang) pelajar memilih Sederhana, 30% (3 orang) memilih Kurang Baik dan 20% (2 orang) memilih Tidak Baik.

Rajah 2. Faktor Media

Faktor Media

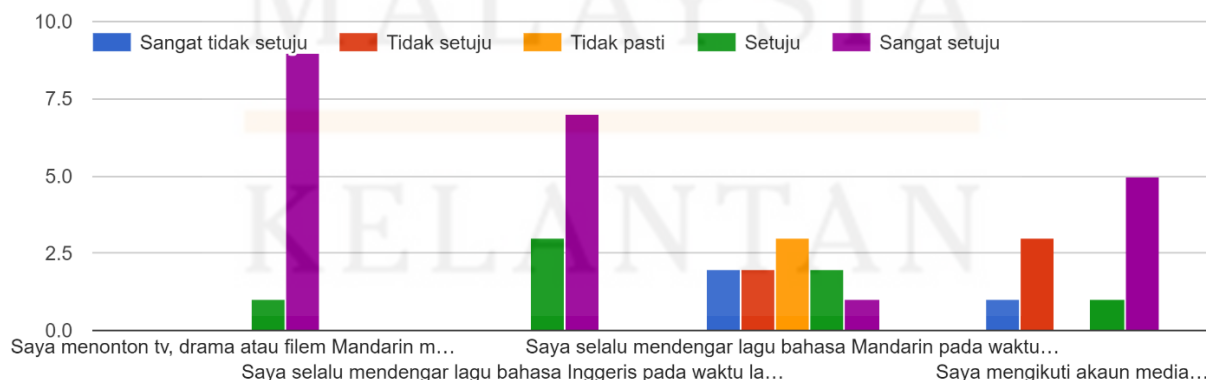

Faktor pertama dalam soalan kaji selidik ini ialah faktor media. Rajah 2 menunjukkan sebanyak 90% daripada responden memilih Sangat Setuju dengan kenyataan saya menonton tv, drama atau filem Mandarin menggunakan sari kata bahasa Inggeris. Bagi kenyataan saya selalu mendengar lagu bahasa Inggeris pada waktu lapang pula, sebanyak 70% daripada responden telah memilih Sangat Setuju bagi kenyataan tersebut.

Manakala bagi kenyataan saya selalu mendengar lagu bahasa Mandarin pada waktu lapang pula, hanya 10% daripada responden yang memilih Sangat Setuju, manakala 20% daripada responden kajian memilih Tidak Setuju dan 20% memilih Sangat Tidak Setuju. Bagi kenyataan terakhir iaitu saya mengikuti akaun media sosial pembelajaran bahasa Mandarin seperti Twitter, Instagram, TikTok dan lain-lain yang menggunakan bahasa pengantar bahasa Inggeris, sebanyak 50% daripada responden telah memilih Sangat Setuju, 10% memilih Setuju, 30% memilih Tidak Setuju dan 10% memilih Sangat Tidak Setuju.

Rajah 3. Faktor Rakan

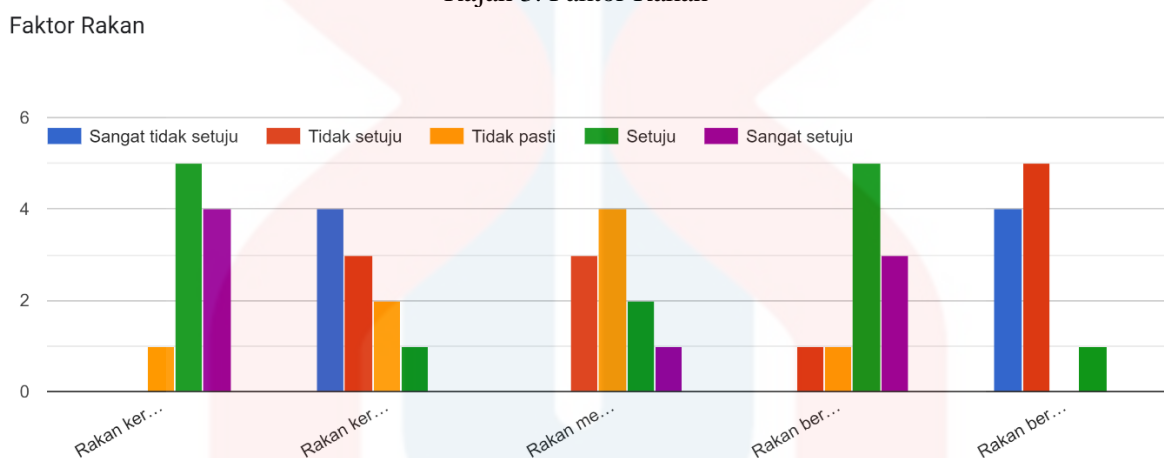

Faktor kedua dalam soalan kaji selidik ini ialah faktor rakan. Sebanyak 40% daripada responden memilih Sangat Setuju dan 50% daripada responden memilih Setuju bagi kenyataan rakan kerap menggunakan bahasa Inggeris ketika bercakap dengan saya. Bagi kenyataan kedua iaitu rakan kerap menggunakan bahasa Mandarin ketika bercakap dengan saya pula, hanya 10% daripada responden memilih Setuju manakala 40% manakala 30% memilih Tidak Setuju dan 40% memilih Sangat Tidak Setuju.

Seterusnya, bagi kenyataan rakan menggunakan bahasa Inggeris untuk memberi penerangan tentang bahasa Mandarin kepada saya, hanya 10% daripada responden memilih Sangat Setuju dan 20% memilih Setuju manakala 30% daripada responden telah memilih Tidak Setuju. Kenyataan selanjutnya ialah rakan berkomunikasi menggunakan bahasa Inggeris ketika melakukan kerja berkumpulan. Sebanyak 30% daripada responden memilih Sangat Setuju dan 50% memilih Setuju manakala hanya 10% memilih Tidak Setuju bagi kenyataan ini. Kenyataan terakhir ialah rakan berkomunikasi menggunakan bahasa Mandarin ketika melakukan kerja berkumpulan dan sebanyak 50% daripada responden telah memilih Tidak Setuju dan 40% memilih Sangat Tidak Setuju.

Rajah 4. Faktor Pengajar

Faktor Pengajar

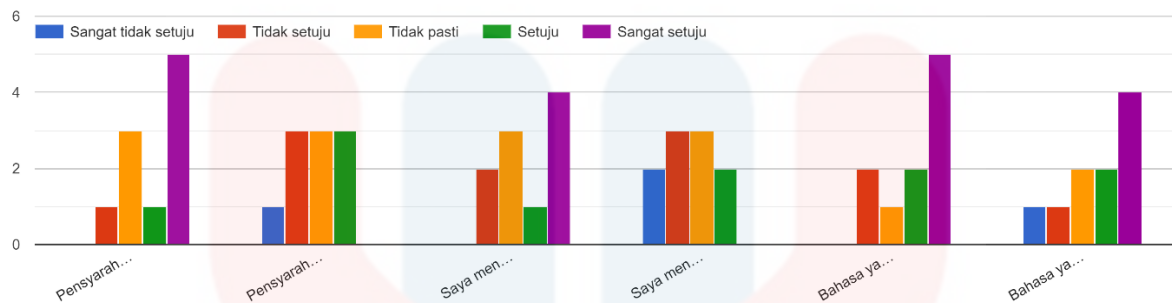

Faktor ketiga dalam soalan kaji selidik ini ialah faktor pengajar. Bagi kenyataan pertama iaitu pensyarah berkomunikasi dengan pelajar menggunakan bahasa Inggeris sewaktu sesi pembelajaran, terdapat 50% daripada responden memilih Sangat Setuju dan 10% memilih Setuju. Seterusnya, terdapat 30% daripada responden memilih Setuju bagi kenyataan pensyarah bertutur menggunakan bahasa Mandarin sepenuhnya sewaktu sesi pembelajaran, 30% memilih Tidak Setuju dan 10% memilih Sangat Tidak Setuju.

Selanjutnya, terdapat 40% daripada responden memilih Sangat Setuju bagi kenyataan saya menggunakan bahasa Inggeris ketika berkomunikasi dengan pensyarah, 10% memilih Setuju manakala 20% memilih Tidak Setuju. Bagi kenyataan saya menggunakan bahasa Mandarin ketika berkomunikasi dengan pensyarah pula, hanya 20% daripada responden memilih Setuju manakala 30% memilih Tidak Setuju dan 20% memilih Sangat Tidak Setuju.

Bagi kenyataan bahasa yang digunakan untuk bahan pengajaran dan pembelajaran seperti modul, PPT, tugas dan lain-lain ialah bahasa Inggeris, sebanyak 50% daripada responden telah memilih Sangat Setuju, 20% memilih Setuju dan hanya 20% memilih Tidak Setuju. Bagi kenyataan bahasa yang digunakan untuk bahan pengajaran dan pembelajaran seperti modul, PPT, tugas dan lain-lain ialah bahasa Mandarin, sebanyak 40% daripada responden memilih Sangat Setuju, 20% memilih Setuju manakala 10% telah memilih Tidak Setuju dan 10% lagi memilih Sangat Tidak Setuju.

Jadual 2. Min Keseluruhan Responden Berdasarkan Faktor Pengaruh Bahasa Inggeris dalam Pembelajaran Bahasa Mandarin Sebagai Bahasa Asing

Persoalan Kajian	Min	Tahap
Apakah tahap media menjadi faktor pengaruh bahasa Inggeris dalam pembelajaran bahasa Mandarin sebagai bahasa asing?	4.00	Tinggi
Apakah tahap rakan sebaya menjadi faktor pengaruh bahasa Inggeris dalam pembelajaran bahasa Mandarin sebagai bahasa asing?	3.04	Sederhana
Apakah tahap pengajar menjadi faktor pengaruh bahasa Inggeris dalam pembelajaran bahasa Mandarin sebagai bahasa asing?	3.42	Sederhana

Jadual 2 menunjukkan analisis keseluruhan item yang menjadi faktor pengaruh bahasa Inggeris dalam pembelajaran bahasa Mandarin sebagai bahasa asing dalam kalangan pelajar Melayu yang tidak pernah bersekolah di Sekolah Jenis Kebangsaan Cina serta sedang mengambil kursus bahasa Mandarin tahap dua di sebuah universiti awam di Malaysia. Berdasarkan analisis tersebut, nilai min pada item media merupakan nilai min pada tahap tinggi iaitu 4.00. Item rakan sebaya dan pengajar pula mendapat nilai min pada tahap sederhana iaitu 3.04 dan 3.42.

KESIMPULAN

Kajian tentang faktor bahasa Inggeris mempengaruhi pembelajaran bahasa Mandarin dalam kalangan pelajar Melayu perlu dijalankan untuk menganalisis masalah semasa mempelajari dalam bahasa Mandarin di peringkat pengajian tinggi terutamanya di university yang menggunakan bahasa Inggeris sebagai bahasa pengantar. Kajian awal ini mengenal pasti beberapa aspek yang menjadi faktor pengaruh bahasa Inggeris dalam pembelajaran bahasa Mandarin sebagai bahasa asing. Hasil kajian awal ini mendapati bahawa media merupakan salah satu faktor besar yang menimbulkan pengaruh bahasa Inggeris dalam pembelajaran bahasa Mandarin.

Walau bagaimanapun, ini hanya merupakan kajian awal yang melibatkan skop kajian yang sangat kecil. Justeru, kajian lanjutan harus dijalankan dengan meningkatkan bilangan responden, mempelbagaikan item soal selidik serta memfokuskan kepada salah satu aspek yang menjadi faktor terbesar sahaja. Dapatan kajian ini diharapkan dapat menjadi sumber maklumat oleh pihak yang terlibat dalam bidang pendidikan bahasa asing di peringkat pengajian tinggi. Dapatan kajian ini juga diharap dapat membantu universiti khususnya ahli akademik melahirkan graduan yang berkualiti dan berkebolehan bertutur dalam bahasa asing dengan baik dan secara tidak langsung akan meningkatkan reputasi universiti dengan pencapaian pelajar yang cemerlang, sekali gus memberi manfaat kepada pembangunan negara khususnya dalam hubungan antarabangsa.

RUJUKAN

- Adzhar, M. A. M., & Radzi, N. M. (2020). KUALITI GURU DAN PENGUASAAN BAHASA CINA MURID SEKOLAH KEBANGSAAN DI SELANGOR. *JuPiDi: Jurnal Kepimpinan Pendidikan*, 7(4), 1-19.
- Darancik, Y. (2018). Students' Views on Language Skills in Foreign Language Teaching. *International Education Studies*, 11(7), 166-178.
- Grenier, G. (2015). The Value of Language Skills. *IZA World of Labor*. <https://doi.org/10.15185/izawol.205>
- Halliday, M. A. K., Matthiessen, C. M., Halliday, M., & Matthiessen, C. (2014). *An introduction to functional grammar*. Routledge.
- Haqiqi, A. F. (2018). *The Interference Of English Variation On Social Media By South-East Asian Students* [AIN SALATIGA].
- Hassan, A. (2021). Faktor-faktor yang Mempengaruhi Pertukaran Kod dalam Pengajaran Guru Bahasa Melayu Sekolah Rendah. *Jurnal Pendidikan Bahasa Melayu*, 11. <https://spaj.ukm.my/jpbm/index.php/jpbm/article/view/254/191>
- Imani, R. (2020). Pengaruh YouTube Terhadap Pemerolehan Bahasa Kedua Pada Anak Usia 8 Tahun. *Metabahasa: Jurnal Pendidikan Bahasa Dan Sastra Indonesia*, 3(1), 11-24.
- Jaafar, R. (2020). STRATEGI PEMBELAJARAN KEMAHIRAN MENDENGAR DAN MENULIS DALAM KALANGAN PELAJAR ETNIK CINA DAN INDIA KETIKA BELAJAR BAHASA MELAYU (Learning Strategy in Listening and Writing Skills among Chinese and Indian Ethnic Student when Learning of Malay Language). *Jurnal Pendidikan Bahasa Melayu*, 10(1), 64-76.
- Kito, K., & Hamada, Y. (2008). Japanese high school students' emotional ratings of the four skills: A first step towards strength-based education. th Annual Pan-SIG Conference, Doshisha University Shinmachi Campus, Kyoto,
- Mamat, M. (2016). Penguasaan Bahasa Inggeris dalam Kalangan Pelajar Tahun Satu di UKM. *Issues in Language Studies*, 5(2). <https://doi.org/10.33736/ils.1636.2016>

- Manap, J., Hamzah, M. R., Amin, A. S., Izani, N. N. M., Idris, F., Hamjah, S. H., Tambi, N., Kasim, A. C., Sarnon, N. H., & Nen, S. (2016). Penggunaan dan Implikasi Media Sosial Terhadap Remaja Generasi Z. International Conference on Social and Economic Development, (November),
- Marican, S. (2005). *Kaedah Penyelidikan Sains Sosial*. Prentice Hall/Pearson Malaysia.
- Meskill, C. (2002). *Teaching and learning in real time: Media, technologies, and language acquisition*. Athelstan.
- Mohammad, W. M. R. W. (2017). Pengaruh Faktor Sosial dalam Pembelajaran Bahasa Melayu dalam Kalangan Murid Iban. *Jurnal Pendidikan Bahasa Melayu* 7. <https://spaj.ukm.my/jpbm/index.php/jpbm/article/view/135/127>
- Mustapha, N. S. A. B., Ahmad, S. A., Jamil, N., & Mustapha, F. (2015). Faktor-faktor Penggunaan Bahasa Inggeris dalam Kalangan Pelajar Semester Akhir Politeknik Kota Bharu. Quality Time Prosiding Seminar Setiausaha-Setiausaha & Pembangunan Pengurusan Kualiti Politeknik Malaysia 2015, Politeknik Kota Bharu.
- Norlida, R. (2018). Kajian Sikap Dan Persepsi Terhadap Pembelajaran Bahasa Mandarin Dalam Kalangan Pelajar UiTM Kelantan. *ESTEEM Journal of Social Sciences and Humanities*, 2. <https://ir.uitm.edu.my/id/eprint/29576/1/29576.pdf>
- Ooi, C. H., & Subramaniam, V. (2017). Faktor Timbulnya Pengaruh Bahasa Pertama dalam Mempelajari Bahasa Melayu sebagai Bahasa Kedua. *Ulum Islamiyyah*, 20. <http://ddms.usim.edu.my/bitstream/123456789/15187/1/ulum%2020%20vol%204.pdf>
- Santoso, A. (2008). Jejak Halliday dalam linguistik kritis dan analisis wacana kritis. *Jurnal Bahasa dan Seni*, 36(1), 1-14.
- Tan, L. N. (2011). *Kemahiran mendengar pelajar Melayu dalam pengajaran dan pembelajaran bahasa Mandarin: satu kajian kes/Tan Lee Na Universiti Malaya*].
- Yusof, R. (2004). *Penyelidikan Sains Sosial*. PTS Pubs. & Distri.

Potensi Caravanserai Sebagai Destinasi Pelancongan Warisan Budaya

Aina Zafirah Samsudin
Pusat Kajian Bahasa Arab dan Tamadun Islam, Fakulti Pengajian Islam,
Universiti Kebangsaan Malaysia
ainazaffirah@gmail.com

Roziyah Sidik @ Mat Sidek
Pusat Kajian Bahasa Arab dan Tamadun Islam, Fakulti Pengajian Islam,
Universiti Kebangsaan Malaysia
&
Institut Islam Hadhari, Universiti Kebangsaan Malaysia
roziyah@ukm.edu.my

ABSTRACT

Caravanserai is a temporary stopover developed along the Silk Road's main trade route. Old World Trade Routes (OWTRAD) has identified that there was approximately 534 caravanserai along the Silk Road. Various nationalities and ethnic groups consisting of caravans of traders, travelers, and pilgrims who pass through this route stop and rest at the caravanserai for a few days before continuing their journey. This caused the caravanserai to be associated as a center for the spread of culture caused by the caravan's presence. This study was conducted to see the potential that exists in the caravanserai so that it can become a cultural heritage tourism destination. This qualitative study uses a content analysis study design and a historical study. Information and data in this writing are obtained from various reference sources among journal articles, reference books, dissertations, and theses that are seen as relevant and related to the title of this article. The results of this study show that there is an evolution in the caravanserai when there are efforts made by various parties in the conservation of the caravanserai for tourism activities which lead to the process of restoration, reconstruction, and adaptive reuse of this building. For example, the conservation efforts of caravanserai to hotels or guesthouses. This effort can indirectly attract the attention of tourists in addition to preserving the remains of history, culture, and heritage. So, one of the potential areas of tourism in the caravanserai is tourism based on cultural heritage. This is further reinforced by the recognition of World Heritage Site status by the United Nations Educational, Scientific and Cultural Organization (UNESCO) of several caravanserais.

Keywords: Caravanserai; Cultural Heritage Tourism; Islamic Civilization.

ABSTRAK

Caravanserai merupakan sebuah tempat persinggahan sementara yang dibangunkan di sepanjang laluan perdagangan utama iaitu Laluan Sutera. Old World Trade Routes (OWTRAD) telah mengenal pasti bahawa terdapat kira-kira 534 buah caravanserai di sepanjang Laluan Sutera. Pelbagai bangsa dan etnik yang terdiri daripada caravan iaitu pedagang, pengembara dan jemaah haji yang melalui laluan ini singgah dan berehat di caravanserai selama beberapa hari sebelum meneruskan perjalanan mereka. Hal ini menyebabkan caravanserai dikaitkan sebagai pusat penyebaran budaya yang disebabkan oleh kehadiran caravan tersebut. Kajian ini dijalankan untuk melihat potensi yang wujud pada caravanserai sehingga ia mampu menjadi destinasi pelancongan warisan budaya. Kajian berbentuk kualitatif ini menggunakan reka bentuk kajian analisis kandungan. Maklumat dan data dalam penulisan ini diperolehi daripada pelbagai sumber rujukan. Antaranya ialah artikel jurnal, buku rujukan, disertasi dan tesis yang dilihat relevan dan berkaitan dengan tajuk artikel ini. Hasil kajian ini menunjukkan bahawa berlaku evolusi pada caravanserai

apabila terdapat usaha yang dilakukan oleh pelbagai pihak dalam pemuliharaan caravanserai untuk aktiviti pelancongan yang membawa kepada proses pembaikpulihan, pemulihan, pembinaan semula dan penggunaan semula bangunan ini. Sebagai contoh, usaha pemuliharaan caravanserai kepada hotel atau rumah tumpangan. Usaha ini secara tidak langsung dapat menarik perhatian pelancong di samping mengekalkan peninggalan sejarah, budaya dan warisan. Maka, salah satu potensi bidang pelancongan di caravanserai ialah pelancongan berasaskan warisan budaya. Ini diperkukuhkan lagi dengan pengiktirafan status Tapak Warisan Dunia oleh Pertubuhan Pendidikan, Saintifik dan Kebudayaan Persatuan Bangsa-Bangsa Bersatu (UNESCO) terhadap beberapa caravanserai.

Kata kunci: Caravanserai; Pelancongan Warisan Budaya; Tamadun Islam.

PENGENALAN

National Geographic (2022) mentakrifkan *caravanserai* sebagai penginapan tepi jalan di sepanjang laluan perdagangan utama seperti Laluan Sutera yang berfungsi sebagai pusat pertukaran barang, idea dan budaya. Berdasarkan kepada UNESCO *Silk Road Program*, *caravanserai* didefinisikan sebagai 'large guest houses or hostels designed to welcome traveling merchants and their caravans' (UNESCO, t.th.). *Caravanserai* juga turut dikenali dengan pelbagai istilah lain seperti *funduq*, *khān*, *han*, *ribāt* dan *wakāla* (Bloom & Blair, 2009; Oxford University Press, 2018). Perkataan *caravanserai* itu sendiri merupakan gabungan daripada perkataan *caravan* dan *serai*. *Caravan* membawa maksud 'sekumpulan pengembara' manakala *serai* pula bermaksud 'istana' (Petersen, 1996; Yilmaz, Yakar & Yildiz, 2008; Krawietz & Riedle, 2019). Oleh itu, *caravanserai* umpama istana bagi sekumpulan pengembara yang terlibat dengan ekspedisi perdagangan untuk beristirahat serta menikmati perkhidmatan dan kemudahan yang disediakan.

Caravanserai merupakan satu kemudahan yang dibangunkan oleh kerajaan secara percuma untuk memberi peluang kepada pedagang, pengembara atau jemaah haji memanfaatkan kemudahan yang disediakan. *Caravanserai* menawarkan penginapan secara percuma lazimnya tidak melebihi tiga hari (Önge, 2007; O'Gorman, 2009; Gurer, 2017). Bukan penginapan sahaja, makanan dan minuman serta perkhidmatan seperti membaiki kasut dan ladam kuda juga disediakan secara percuma (Diyarbekirli, 1992) Selain itu, terdapat juga pelbagai kemudahan lain yang disediakan seperti kandang, masjid, kedai, gudang dan bilik penyimpanan. Bagi sesetengah *caravanserai* yang moden ia dilengkapi dengan pelbagai kemudahan lain seperti farmasi dan tempat membaiki kenderaan dagangan. Jadi para pengembara tidak perlu risau jika singgah di *caravanserai* kerana semua kelengkapannya sudah disediakan (Sims, 1996).

Hari ini, terdapat banyak *caravanserai* yang masih digunakan serta menjadi destinasi pelancongan. Hal ini demikian kerana pelbagai usaha dan inisiatif telah diambil oleh pihak kerajaan dalam menaik taraf *caravanserai* agar dapat menarik kemasukan pelancong. Pendekatan yang dilakukan ini juga secara tidak langsung telah mengekalkan nilai peninggalan sejarah yang terdapat pada sesebuah *caravanserai*. Justeru, kajian ini dilakukan untuk mencapai dua objektif. Objektif pertama adalah untuk meneliti usaha penaiktarafan *caravanserai* sebagai destinasi pelancong. Objektif kedua adalah untuk mengkaji potensi *caravanserai* sebagai destinasi pelancongan warisan budaya.

METODE

Kajian ini menggunakan reka bentuk kajian kualitatif dengan menggunakan pendekatan analisis kandungan. Penulis memulakan penyelidikan dengan kajian literatur bagi mencari kata kunci untuk digunakan pada peringkat analisis kandungan. Tujuan utama analisis kandungan adalah untuk mengenalpasti potensi *caravanserai* sebagai destinasi pelancongan warisan budaya. Justeru, carian sumber dibuat secara menyeluruh berdasarkan sumber-sumber berautoriti iaitu meliputi buku, jurnal akademik dan laman sesawang. Penulis memilih pendekatan analisis kandungan kerana ia mempunyai kelebihan tersendiri termasuklah tahap sensitivitinya ke atas kandungan teks sesuatu dokumen atau laporan (Krippendorff, 2013).

Seterusnya, persampelan artikel untuk analisis kandungan dilakukan melalui dua peringkat. Pada peringkat pertama, penulis mengadaptasi kaedah pencarian artikel berpandukan kepada penggunaan kata kunci. Carian melibatkan artikel-artikel ilmiah dan disiplin yang berkaitan melalui platform pencarian *Scopus*, *EBSCOhost* dan *Google Scholar*. Kata kunci yang digunakan ialah *caravanserai* dan pelancongan budaya. Pada peringkat seterusnya pula, penulis melakukan semakan terhadap senarai rujukan pada bahagian akhir artikel yang dirujuk pada peringkat permulaan. Dengan metode sebegini, penulis akan mendapat tambahan artikel untuk digunakan semasa analisis kandungan. Hasilnya, penulis telah menyediakan satu pengkalan data yang komprehensif dan terkini untuk tujuan pelaksanaan analisis kandungan.

Bagi proses analisis data pula, penulis melakukannya secara berperingkat. Proses ini dimulakan dengan menganalisis kandungan tersurat (*manifest*) dan diikuti dengan menganalisis kandungan tersirat (*latent*). Ini selaras dengan pandangan Bryman (2012) iaitu "...semasa mengumpul data mentah, analisis bukan sahaja melibatkan kandungan tersurat, malah melibatkan juga kandungan tersirat bagi mendalami dan merungkai makna yang lebih mendalam tentang segala persoalan".

DAPATAN KAJIAN

Hasil dapatan dalam kajian ini memfokuskan kepada dua perbahasan utama sahaja iaitu *caravanserai* dalam tamadun Islam dan penaiktarafan *caravanserai* sebagai destinasi pelancongan.

***Caravanserai* dalam Tamadun Islam**

Dari segi sejarah, *caravanserai* menyokong aliran perdagangan, maklumat dan orang ramai merentasi rangkaian Laluan Sutera yang menghubungkan Asia, Afrika Utara dan Eropah. *Caravanserai* adalah titik tumpuan penting di sepanjang rangkaian Laluan Sutera. Beribu-ribu *caravanserai* telah dibina di seluruh dunia sepanjang milenium dari abad ke-9 hingga ke-19, berikutan daripada penyebaran dan kestabilan pemerintahan Islam di wilayah di seluruh benua yang membawa kepada pertumbuhan sektor perdagangan. Terdapat beberapa istilah lain bagi *caravanserai* yang lazim digunakan di rantau yang berbeza, seperti *Funduk* di Afrika Utara, *Tash Rabat* di Asia Tengah dan *Wakala* di Turki. Walau bagaimanapun, *caravanserai* kekal sebagai istilah popular di seluruh dunia (Tarar, t.th).

Caravanserai juga berfungsi sebagai tempat pertukaran budaya, bahasa, agama dan adat disebabkan oleh kehadiran pelbagai orang yang ingin menikmati kemudahan yang disediakan di *caravanserai* khususnya penginapan. *Caravanserai* juga memainkan peranan utama dalam kehidupan ekonomi, sosial dan budaya (Tarar, t.th). *Caravanserai* Sultan Han

misalnya berperan dalam kelestarian interaksi perdagangan dan pertukaran budaya (Gürani, & Canbolat, 2012). Walau bagaimanapun, kajian yang memfokuskan kepada fungsi *caravanserai* pernah dilakukan oleh sarjana antaranya termasuk O’Gorman & Prentice (2008), Lally (2009), Karluk & Karaman (2014), Floor (2015) dan Swarbrooke (2018). Hasil kajian mereka mendedahkan bahawa *caravanserai* merupakan sebuah tempat persinggahan para pelayar, pedagang, pengembara dan juga jemaah haji untuk berehat dan menyimpan barang.

Sebagai tempat persinggahan perdagangan, *caravanserai* berkembang menjadi tempat perdagangan. Kajian Daviau (1993) membuktikan tentang perkembangan fungsi *caravanserai* dengan menyatakan bahawa terdapat satu ruang di dalam *caravanserai* yang dijadikan sebagai tempat untuk berniaga dan melakukan aktiviti komersial. Para pedagang sering membawa barang dagangan antaranya yang terdiri daripada barang kemas, kosmetik dan tangkal azimat. Perkembangan fungsi *caravanserai* daripada tempat penginapan kepada tempat perdagangan boleh diterima kerana sebahagian ruang di dalam *caravanserai* mempunyai fungsi sementara (Sussely, 2007). Maka, para pedagang boleh menggunakan *caravanserai* pada waktu pagi untuk berdagang dan pada waktu malam pula ia dijadikan sebagai tempat penginapan.

Terdapat juga kajian lepas yang tertumpu kepada kos penginapan sepanjang berada di *caravanserai*. Walaupun banyak kemudahan disediakan di *caravanserai* seperti masjid, farmasi dan lain-lain, namun kajian Brosnahan (2005) menyatakan bahawa ia menawarkan penginapan percuma yang lazimnya tidak melebihi tiga hari. Namun, Della (2005) mendedahkan *caravanserai* di Iran dapat dimanfaatkan secara percuma selama setahun oleh pelbagai pihak termasuk pedagang, jemaah haji mahupun pelancong. Pandangan Farshchi dan Zamani (2019) pula menyatakan bahawa penggunaan bilik di *caravanserai* sebagai penginapan diberikan secara percuma atau dengan sejumlah bayaran yang murah. Oleh kerana ia diberi secara percuma, *caravanserai* juga dikaitkan sebagai kemudahan penginapan kepada golongan miskin (Johar & Chopra 2017).

Penaiktarafan *Caravanserai* Sebagai Destinasi Pelancongan

Caravanserai dalam tamadun Islam dikaitkan dengan pelancongan. Simbiosis antara kedua-duanya dapat dilihat menerusi tinjauan yang dilakukan ke atas kajian-kajian lepas. Dapatan kajian ini menunjukkan bahawa *caravanserai* di Turki dan Iran tidak hanya berfungsi sebagai tempat persinggahan sahaja. Sebaliknya ia turut berkembang menjadi destinasi pelancongan pada hari ini. Antara *caravanserai* tersebut ialah *Caravanserai Mahperi Hatum*, *Caravanserai Orkney*, *Caravanserai Sultan Han*, *Caravanserai Sa’d al-Saltaneh*, *Caravanserai Maranjab* dan *Caravanserai Zeinodin*. Dapatan ini disokong oleh banyak kajian lepas seperti Hashemi, Talebian & Taleqni (2012), Islamic Republic of Iran’s Presentation on “Tourism Product Development” (2013), Erdem (2015), Ghasemi & Gholamalizadeh (2015), Yazarlou (2015), Khaleh, Hadavi & Zamani (2016), Zeinizadeh (2016), Bakhtiari & Allahyari (2018), Medina (2018) dan Ahunbay (2019).

Menurut Yazarlou (2015), pendekatan menaik taraf *caravanserai* dilakukan untuk menjadikannya sebagai pusat pelancongan budaya dan ekotourism. Naik taraf kemudahan melibatkan pewujudan tempat aktiviti jualan kraftangan dan cenderamata di *caravanserai* yang terdapat di Mazandaran. Secara tidak langsung, ia mampu meningkatkan ekonomi di samping menarik pelancong melawati tempat bersejarah. Di Iran, usaha menaiktaraf *caravanserai* dilakukan dengan cara membaik pulih bangunan sedia ada untuk dijadikan sebagai tempat pelancongan (Bakhtiari & Allahyari 2018). Usaha yang sama dikesan berlaku di Turki apabila bangunan *caravanserai* dibaik pulih untuk dijadikan sebagai salah satu pusat komersial (Ahunbay 2019).

Penaiktarafan *caravanserai* kebiasaannya dilakukan oleh kerajaan dalam usaha memelihara monumen bersejarah di samping untuk menarik pelancong domestik dan

antarabangsa. *Caravanserai* merupakan sebuah monumen bersejarah yang mampu menarik pelancong. Kedatangan pelancong ke *caravanserai* juga sekaligus menyumbang kepada kadar pertumbuhan ekonomi apabila ramai pelancong yang datang berkunjung (Khaleh et al., 2016). Kajian yang dikhususkan kepada *caravanserai* tertentu sebagai destinasi pelancongan juga turut dijalankan. Medina (2018) misalnya mengkaji *Caravanserai* Orkney sebagai destinasi pelancong. *Caravanserai* Orkney merupakan sebuah destinasi pelancongan untuk melihat arkeologi, geografi, sejarah dan budaya yang terdapat di kawasan itu.

PERBINCANGAN

Caravanserai pada asasnya dibina sebagai tempat persinggahan sementara. Namun, fungsinya semakin berkembang dengan terdapatnya pelbagai kemudahan sehinggakan *caravanserai* mampu menjadi daya tarikan pelancong dari dalam dan luar negara. Hasil daripada analisis kandungan yang dilakukan, penulis menemukan dapatan bahawa monumen *caravanserai* mempunyai potensi untuk dijadikan sebagai destinasi pelancongan warisan budaya kerana pelbagai inisiatif dan usaha telah dilakukan untuk memelihara peninggalan sejarah, budaya dan warisan yang terdapat pada monumen bersejarah ini.

Potensi Pelancongan Warisan Budaya di *Caravanserai*

Dapatan kajian menunjukkan bahawa wujud hubungan yang signifikan antara *caravanserai* dengan pelancongan. *Caravanserai* yang dibangunkan pada zaman lalu telah menjadi sebahagian daripada bangunan bersejarah pada hari ini dan sebuah destinasi pelancongan yang menarik untuk dikunjungi. Fielden (2000) mendefinisikan bangunan bersejarah sebagai sebuah bangunan yang dapat memberikan manusia perasaan kagum dan ingin mengetahui secara lebih lanjut mengenai bangsa dan budaya yang menghasilkannya. Dalam erti kata lain, sesebuah bangunan itu boleh disebut sebagai bangunan bersejarah sekiranya ia mempunyai nilai seperti seni bina, estetik, sejarah, arkeologi, ekonomi, politik, sosial, rohani dan simbolik (Siti Norsakira, 2018). Bangunan bersejarah ini bukan sahaja menjadi simbol kepunyaan sesebuah budaya malah ia juga menjadi sebahagian daripada warisan sesebuah negara dan ia seharusnya dikekalkan untuk generasi akan datang.

Elemen budaya, seni dan warisan amat berkait rapat dalam memajukan sektor pelancongan negara. Aktiviti pelancongan budaya ini antaranya merangkumi lawatan ke bangunan-bangunan bersejarah. Herbert (1989) berpendapat bahawa pelancong lebih gemar mendapat pengalaman sendiri di tempat tinggalan sejarah daripada mengetahuinya melalui pembacaan sejarah masa lalu. Tarikan budaya yang bersifat autentik ini mampu meningkatkan pengetahuan di samping memberi hiburan dan pengalaman kepada pelancong (Siti Norsakira & Rosniza Aznie, 2018). Ini mempunyai kesinambungan apabila pelancong menginap atau melawat di *caravanserai* yang berusia berabad-abad. Mereka akan memperolehi pengalaman yang luas dan berpeluang untuk merasai kembali masa lalu (*Tehran Times*, 2021a). Justeru itu, pelancongan budaya merupakan salah satu tarikan utama dalam pembangunan produk pelancongan (Habibah Ahmad et al., 2011).

Pelancongan budaya menurut pandangan Smith (1989) ialah berdasarkan kepada dua sudut. Sudut pertama ialah kecenderungan para pelancong untuk pergi ke sesebuah destinasi kerana didorong oleh faktor budaya dan aktiviti berkaitan dengan budaya yang dilakukan di sesebuah destinasi. Dorongan tersebut adalah keinginan pelancong untuk melihat sendiri pengalaman budaya dalam kalangan sesebuah masyarakat di sesebuah destinasi. Sudut kedua pula ialah himpunan produk yang ditakrifkan sebagai “budaya” yang ditawarkan di sesebuah destinasi. Robinson dan Boniface (1999) berpandangan bahawa pelancongan budaya merupakan satu perjalanan yang dibuat bagi melihat dan mengalami keadaan budaya di sesuatu

tempat atau membiasakan seseorang dengan budaya yang ada disesuatu kawasan dan ciptaannya.

Pelbagai inisiatif boleh dijalankan untuk memelihara produk warisan yang ditinggalkan. Salah satu alternatif yang boleh dilakukan dalam usaha untuk mengekalkan produk warisan pada bangunan bersejarah adalah melalui pendekatan penggunaan semula secara adaptif. Torar (t.th) membuktikan bahawa terdapat banyak negara telah mengambil inisiatif dalam memulihkan bangunan *caravanserai* antaranya ialah Iran, Turki dan China. Pendekatan ini telah diperkenalkan oleh para penyelidik dalam usaha untuk mengekalkan bangunan bersejarah ini kepada generasi akan datang. Seiring dengan peredaran masa, penggunaan bangunan ini mungkin berubah dari tujuan utama kepada tujuan baharu. Perubahan ini berlaku bagi memenuhi keperluan semasa di samping untuk mengekalkan keaslian yang terdapat padanya (Adlin Baizura et al., 2017). Walau bagaimanapun, Coetier (2002) mendedahkan fungsi baharu pada bangunan bersejarah mestilah mengikut bentuk asal bangunan bagi mengekalkan sifat asal bangunan bersejarah tersebut dan bukannya bentuk mengikut fungsi baharu.

Bangunan warisan berhadapan dengan keusangan fungsi, fizikal atau sosial. Pemuliharaan dan penggunaan semula bangunan warisan secara adaptif perlu dipertimbangkan dari segi keadaan, pengurusan dan kepentingan budaya. Setiap bangunan warisan mempunyai nilai dan ciri yang tersendiri justeru bangunan usang yang masih wujud boleh dihidupkan semula dan diubah fungsinya. Dalam proses pemuliharaan ini, perhatian terhadap nilai warisan budaya sesebuah bangunan, keunikan dan keaslian ruang seperti bentuk asal, reka bentuk dan bahan perlu diberi perhatian lebih. Pemulihan dan pemuliharaan monumen termasuk *caravanserai* boleh menyumbang kepada pertumbuhan dan perkembangan pelancongan budaya di samping dapat memelihara warisan budaya. Malah, pelancongan budaya boleh digunakan sebagai kunci kejayaan pemuliharaan bangunan warisan. Kesenambungan dalam projek penggunaan semula secara adaptif seperti bangunan *caravanserai* dijangka dapat mengekalkan latar belakang sejarah masa lalu (Abbasian, 2019).

Pendekatan penggunaan semula secara adaptif misalnya dilakukan pada bangunan *caravanserai* yang terletak di Laluan Sutura antaranya ialah *Caravanserai* Sultan Han, *Caravanserai* Sa'd al-Saltaneh, *Caravanserai* Maranjab dan *Caravanserai* Zeinodin. Abbasian (2019) menyatakan penggunaan semula ini menunjukkan tahap intervensi yang berbeza seperti perubahan pada ruang dalaman dan luaran. Walau bagaimanapun, terdapat perkara yang sama iaitu mengenai pemuliharaan untuk tujuan pelancongan, menghidupkan semula bangunan bersejarah dan memilih fungsi baharu yang sesuai mengikut latar belakang sejarah bangunan dan fungsi asal. *Tehran Times* (2021b) mendedahkan bahawa terdapat *caravanserai* yang diubah suai secara eksklusif dan digunakan semula sebagai hotel butik dan penginapan pelancong pada hari ini. Bukan itu sahaja, *caravanserai* juga mempunyai fungsi baharu sebagai sebuah restoran. Ini dibuktikan oleh Torar (t.th) bahawa pada abad ke-14, *Caravanserai* Multani di Azerbaijan misalnya telah menjalani proses pemuliharaan dan kini ia telah digunakan sebagai sebuah restoran masakan Azerbaijan.

Selain itu, produk berasaskan warisan yang berpotensi untuk dipromosikan sudah semestinya tapak yang telah diiktiraf oleh UNESCO sebagai Tapak Warisan Dunia. Ia juga merupakan salah satu usaha dalam menarik lebih banyak pelancong asing untuk melawat dan melihat kepelbagaian budaya dan keindahan alam semula jadi di sesebuah destinasi (Zuliskandar et al., 2015). Menurut Siti Norsakira dan Rosniza Aznie (2018), pengiktirafan daripada pihak UNESCO sebagai Tapak Warisan Dunia ini bertujuan menyediakan peluang yang istimewa bagi memelihara keunikan luar biasa di seluruh dunia serta untuk melindungi tapak-tapak warisan bagi mencerminkan kepelbagaian budaya dan alam semula jadi yang telah wujud agar ianya terus kekal. Dengan pengiktirafan ini, sejarah Tapak Warisan Dunia juga dapat diketahui oleh pelancong antarabangsa (Li, Ahmad & Jusoh, 2018).

Menurut UNESCO (1999), Tapak Warisan Dunia UNESCO ialah sebuah tapak yang mempunyai kepentingan nilai sejagat yang perlu dikongsi dengan semua negara di dunia. Bukan sesuatu prosedur yang mudah untuk sesebuah negara mendapat pengiktirafan bagi sesebuah tapak, kawasan, bangunan atau sesuatu monumen digazetkan sebagai warisan dunia. Pertimbangan yang teliti dilakukan oleh UNESCO berdasarkan kepada ciri-ciri kepentingan nilai sejagat yang ada pada sesebuah tapak itu sebelum mengisytiharkannya sebagai warisan dunia.

Penyenaraian sesebuah tapak atau kawasan sebagai Tapak Warisan Dunia UNESCO bermakna sesebuah tapak atau kawasan itu perlu dikongsi bersama dengan seluruh dunia tanpa mengira bangsa dan negara. Pengiktirafan sebagai Tapak Warisan Dunia ini telah menunjukkan kesan positif dalam peningkatan jumlah kedatangan pelancong dan aktiviti pelancongan (Poria, Reichel & Cohen, 2011). Ini turut diperakui oleh Henderson (2007) bahawa dengan adanya tempat bersejarah ia akan mempengaruhi masyarakat setempat. Walau bagaimanapun, menurut Shackley (2006) pengiktirafan sebagai tapak bersejarah ini secara tidak langsung akan merangsang pertumbuhan ekonomi dalam kalangan komuniti. Manakala, pengiktirafan Tapak Warisan Dunia UNESCO juga mampu melonjakkan kadar pertumbuhan ekonomi negara (Bernama, 2008).

Kaitan dengan *caravanserai* di lihat pada *Caravanserai* Sa'd al-Saltaneh di Iran yang telah dibaik pulih dalam usaha untuk menarik lebih ramai pelawat antarabangsa jika ia mendapat status Tapak Warisan Dunia UNESCO. Dalam pada itu, para pelancong akan memperolehi pengalaman yang luas dan merasai keindahan seni bina Parsi yang luar biasa di *Caravanserai* Sa'd al-Saltaneh (*Tehran Times*, 2021a). Bukan itu sahaja, beberapa *caravanserai* lain di Iran juga telah mendapat pengiktirafan Tapak Warisan Dunia UNESCO antaranya ialah *Caravanserai* Izadkhast dan *Caravanserai* Zeinodin. Manakala, turut terdapat juga beberapa *caravanserai* di Turki yang telah diwartakan sebagai Tapak Warisan Dunia, iaitu membabitkan *Caravanserai* Akhan, Ertokus Han dan Saadettin Han. Menurut Polat (2018), kesemua *caravanserai* di Turki ini dipilih sendiri oleh UNESCO untuk dikomersialkan.

Selain itu, *Tehran Times* (2021c) melaporkan bahawa *Caravanserai* Sarayan di Iran telah menerima kelulusan awal daripada pakar warisan budaya untuk menyertai *shortlist of Iranian historical caravanserais* yang sedang disediakan untuk kemungkinan inskripsi dalam senarai Warisan Dunia UNESCO. *Caravanserai* ini terletak di wilayah timur Khorasan Selatan. *Caravanserai* Sarayan masih digunakan dan merupakan salah satu tarikan pelancong yang tertua di bandar ini. Kerja-kerja pemulihan *caravanserai* ini sedang dijalankan sebagai persediaan untuk dinilai oleh pakar UNESCO. Pendaftaran global monumen bersejarah ini boleh menyumbang kepada pemeliharaan dan perlindungan dan akan membawa kepada peningkatan kemakmuran ekonomi di negara tersebut dengan menarik lebih ramai pelancong.

KESIMPULAN

Melalui pelancongan, perlindungan warisan bersejarah ini dapat menarik minat masyarakat, menambahkan pengetahuan serta mewujudkan rasa penghargaan terhadap demografi sejarah sesebuah elemen warisan tersebut. Perlindungan bangunan bersejarah atau warisan termasuk *caravanserai* sangat penting dan perlu diberi perhatian. Hal ini demikian kerana perlindungan terhadap khazanah warisan yang terancang dapat dikekalkan, dipelihara dan dipelihara dengan baik supaya dapat ditunjukkan kepada generasi akan datang. Selain itu, ia juga boleh menyumbang kepada pertumbuhan dan perkembangan pelancongan budaya di samping dapat memelihara warisan budaya. Oleh itu, monumen *caravanserai* yang berpotensi untuk dibangunkan sebagai sebuah destinasi pelancongan perlu diisytiharkan sebagai warisan negara. Hal ini kerana pengisytiharan Tapak Warisan Dunia oleh UNESCO adalah penting bagi memberi perlindungan yang sewajarnya.

PENGHARGAAN

Kajian ini ditaja oleh Skim Geran Penyelidikan Fundamental (FRGS) (FRGS/1/2020/SSIO/UKM/02/20).

RUJUKAN

- Abbasian, A. (2019). *Examining Authenticity in Adaptive Reuse of Iranian Caravanserais for Tourism: Comparative Assessment of Two Cases from Safavid Era* (Tesis Sarjana, Eastern Mediterranean University, Turki). Diakses pada Oktober 14, 2022, daripada [http://i-rep.emu.edu.tr:8080/jspui/bitstream/11129/5205/1/Abbasianaryana .pdf](http://i-rep.emu.edu.tr:8080/jspui/bitstream/11129/5205/1/Abbasianaryana.pdf)
- Adlin Baizura Ariffin, Mohd Salehuddin Mohd Zahari, Salleh Mohd Radzi & Mohd Zain Kutub (2017). Adaptive reuse of historical buildings and local residents' actual visitation. *Journal of Tourism, Hospitality & Culinary Arts (JTHCA)*, 9(2), 1-12.
- Ahunbay, Z. (2019). Giving new life to historic buildings. International Civil Engineering and Architecture Conference 2019, 17-20 April.
- Bakhtiari, S., & Allahyari, F. (2018). Investigation and Analysis of the Experience of Isfahan in the Re-Functionalization of Caravanserais as Tourist Facilities. *The Journal of Social Science Institute*, (IWACT' 18 Special Issue), 23-44.
- Bernamea Official Portal. (2008, November 22). *Pengiktirafan tapak warisan dunia UNESCO mampu lonjak ekonomi negara*. Diakses pada Oktober 14, 2022, daripada http://www.bernama.com/bernama/v3/bm/news_lite.php?id=373739
- Bloom, J. M., & Blair, S. S. (2009). *The Grove encyclopedia of Islamic art and architecture*. New York: Oxford University Press.
- Brosnahan, T. (2005). *Turkey: bright sun, strong tea: on the road with a travel writer*. London: Travel Info Exchange.
- Bryman, A. (2012). *Social research methods* (4th ed.). United Kingdom: Oxford University Press.
- Coeterier, J. F. (2002). Lay people's evaluation of historic sites. *Landscape and Urban Planning*, 59(2), 111-123.
- Daviau, M. (1993). *Houses and their furnishings in Bronze Age Palestine: Domestic activity areas and artifact distribution in the middle and late bronze ages*. Sheffield: Sheffield Academic Press.
- Della, V. P. (2005). *Dela Vale Travelogue*. Terj. Jil. 1. Tehran: Ghatre.
- Diyarbakirli, N. (1992). Turkish Contributions to Cultural and Commercial Life along Silk Road. *Senri ethnological studies*, 32, 171-192.
- Erdem, B. (2015). Contribution of the tourism on economy: Tokat sample. *Journal of International Management, Educational and Economics Perspectives*, 1(1), 29-38.
- Farshchi, H.R., & Zamani, M.H. (2019). A study of Iranian caravanserais and related buildings. *Iranian Journal of Architecture and Urban Planning*, 2(7), 1-13.
- Fielden, B.M. (2000). *Conservation of Historic Buildings*. Oxford: Architectural Press.
- Floor, W. (2015). Hotels in Iran, 1870-1940. *Studia Iranica*, 44(2), 277-314.
- Ghasemi, F., & Gholamalizadeh, H. (2015). The principles of designing the "Silk Road Hotel-Faculty" inspired by the usage of caravanserais in this international road. *European Online Journal of Natural and Social Sciences*, 3(3), 969-987.
- Gürani, F.Y., & Canbolat, T.Ö. (2012). Aksaray Sultanhan Caravanserai: A Study of Cultural Interactions and Sustainability along the Silk Road. In *2nd International Conference Archi-Cultural Translations through the Silk Road* (pp. 277-279).

- Gurer, A.S. (2017). Caravanserais and the Security Problems of the Anatolian Silk Road in the Seljuk Period. *The Journal of Middle East and Central Asian Studies Contents*, 1(2017), 55-62.
- Habibah Ahmad , Hamzah Jusoh , Chamhuri Siwar , Amriah Buang , Mohamad Shukri Hj Noor , Shahrudin Mohd Ismail, Zairin Akma Zolkapli. (2011). Pelancongan budaya di koridor ekonomi wilayah Pantai Timur (ecer): isu dan cabaran. *Geografia-Malaysian Journal of Society and Space*, 7(5), 180-189.
- Hashemi, S., Talebian, M.H., & Taleqni, E.M. (2012). Determining the position of Ahovan caravansary in Silk Road Route. *Journal of Basic and Applied Scientific Research*, 2(2), 1479-1489.
- Henderson, J. C. (2007). *Tourism Crises: Causes, Consequences and Management*. Jordan Hill: Elsevier Inc.
- Herbert, D.T. (1989). Does interpretation help? In Herbert, D.T., Prentice, R.C., & Thomas, C.J. (Eds.). *Heritage sites: Strategies for marketing and development*. (pp. 191-130). Aldershot, Avebury.
- Islamic Republic of Iran's Presentation on "Tourism Product Development"*. (2013). Slaid. Ankara: Iranian Cultural Heritage, Handicraft and Tourism Organization.
- Johar, S., & Chopra, K. (2017). A survey of Mughal caravanserais in Eastern Punjab (India). *The International Conference on Land Transportation, Locomotive Heritage and Road Culture*. hlm 35-42.
- Karluk, S. R., & Karaman, S. C. (2014). Bridging civilizations from Asia to Europe: The Silk Road. *Chinese Business Review*, 13(1), 730-739.
- Khaleh, E.N.H., Hadavi, F., & Zamani, M. (2016). Identification of the relationship between tourism industry development and economic growth of Zanjan Province. *The Scientific-Research Quarterly Journal of Urban Economics and Management*, 4(3), 75-93.
- Krawietz, B., & Riedler, F. (2019). *The Heritage of Edirne in Ottoman and Turkish Times: Continuities, Disruption and Reconnections. Volume 34 of Studies in History and Culture of the Middle East*. Berlin: Walter de Gruyter GmbH & Co.
- Krippendorff, K. (2013). *Content analysis: an introduction to its methodology* (3rd ed.). United Kingdom: SAGE Publication.
- Lally, J. (2009). *The pattern of trade in seventeenth-century Mughal India: Towards an economic explanation*. Economic History Working Paper No.120/09. Diakses pada Oktober 14, 2022, daripada <http://eprints.lse.ac.uk/27868/1/1WP120.pdf>
- Li, N. S., Ahmad, H., & Jusoh, H. (2018). Interaksi tuan rumah dan pelancong antarabangsa dalam pelancongan budaya di Kampung Morten, Melaka. *Jurnal Wacana Sarjana*, 2(1), 1-18.
- Medina, L. (2018). Orkney Caravanserai. Dlm. Dalgetty, C., Dilley, S., Houston, S., Leask, A., Logie, F., Mair, N., Rice, K., & Whitelaw, D (pnyt.). *Scott Sutherland Yearbook 2018*. UK: Robert Gordon University.
- Siti Norsakira Mohamed & Rosniza Aznie Che Rose. (2018). Potensi bandar Kuala Lipis sebagai destinasi pelancongan warisan. *Geografia-Malaysian Journal of Society and Space*, 14(1), 102-115.
- National Geographic. (2022, May 19). Caravanserai. *National Geographic Encyclopedia Entry*. Diakses pada Oktober 21, 2022, daripada <https://education.nationalgeographic.org/resource/caravanserai/>
- O’Gorman, K. D. (2009). Origins of the commercial hospitality industry: from the fanciful to factual. *International Journal of Contemporary Hospitality Management*, 21(7), 777-790.

- O’Gorman, K.D., & Prentice, R.C. (2008, October). Iranian hospitality: from caravanserai to bazaar to reporting symbolic experience. In *EuroCHRIE 2008 Congress*, University of Strathclyde. Dubai, 11-14 October.
- Önge, M. (2007). Caravanserais as symbols of power in Seljuk Anatolia. *Politica*, 306(21), 49-69.
- Oxford University Press. (2018, May 9). Caravanserai. *Encyclopedia.com*. Diakses pada Oktober 21, 2022, daripada <https://www.encyclopedia.com/literature-and-arts/art-and-architecture/architecture/caravanserai>
- Petersen, A. (1996). *Dictionary of Islamic architecture*. London: Routledge.
- Polat, N. (2018). Creating New Touristic Fashion Routes with Caravanserais on the Ancient Silk Road in Turkey. *Journal of Tourism, Culture and Territorial Development*, Special Issue (9), 213-224.
- Poria, Y., Reichel, A., & Cohen, R. 2011. World Heritage Site: Is it an effective brand name? a case study of a religious heritage sites. *J. Travel Res* 50, 482–495.
- Robinson, M. & Boniface, P. (1999). *Tourism and Cultural Conflicts*. New York: CABI Publishing.
- Shackley, M. (2006). *Visitor Management at World Heritage Sites*. In *Managing World Heritage Sites*. United Kingdom: Butterworth-Heinemann
- Sims, E. (1996). Trade and travel: Markets and caravanserai. In. Michell, G (ed.). *Architecture of the Islamic World Its History and Social Meaning* (pp.80-111). London: Hudson Ltd.
- Siti Norsakira Binti Mohamed. (2018). *Pelancongan warisan sebagai tunjang pembangunan bandar Kuala Lipis*. (Tesis Sarjana, Fakulti Sains Sosial dan Kemanusiaan, Universiti Kebangsaan Malaysia).
- Smith, V.L. (1989). *Hosts and Guests: The Antropology of Tourism*. Philadelphia: University of Pennsylvania Press.
- Sussely, Y. T. (2007). Ancient caravanserais: an archaeological view from ‘aroer. *Levant* 39, 123-141.
- Swarbrooke, J. (2018). *The meaning of luxury in tourism, hospitality and events*. Oxford: Goodfellow Publishers.
- Tehran Times. (2021a, September 24). *UNESCO inspectors to visit Sa’d al-Saltaneh caravanserai*. Diakses pada Oktober 21, 2022, daripada <https://www.tehrantimes.com/news/465398/UNESCO-inspectors-to-visit-Sa-d-al-Saltaneh-caravanserai>
- Tehran Times. (2021b, December 19). *Ancient caravanserai restored to host modern trippers*. Diakses pada Oktober 21, 2022, daripada <https://www.tehrantimes.com/news/468239/Ancient-caravanserai-restored-to-host-modern-trippers>
- Tehran Times. (2021c, June 16). *Sarayan caravanserai joins shortlist for collective world heritage*. Diakses pada Oktober 21, 2022, daripada <https://www.tehrantimes.com/news/462061/Sarayan-caravanserai-joins-shortlist-for-collective-world-heritage>
- Torar, N.O. (t.th). *Cultural heritage on the Cusp of Silk Roads: Caravanserai Kharbooza in Islamabad*. Diakses pada Oktober 21, 2022, daripada <https://hilal.gov.pk/eng-article/detail/MjMwMg==.html>
- UNESCO. (n.d.). *Caravanserais: cross-roads of commerce and culture along the Silk Roads*. Diakses pada Oktober 21, 2022, daripada <https://en.unesco.org/silkroad/content/caravanserais-cross-roads-commerce-and-culture-along-silk-roads>
- UNESCO. (1999). *Historic town of Vigan*. Diakses pada Oktober 16, 2022, daripada <https://whc.unesco.org/uploads/nominations/502rev.pdf>
- Yazarlou, M. (2015). Thinking relatively on nature concept with creating “Modern Tourism Space” at Mazandaran through tourism approach. *Current World Environment*, 10(1), 967-978.

- Yilmaz, H. M., Yakar, M., & Yildiz, F. (2008). Documentation of Historical Caravansaries by Digital Close-Range Photogrammetry. *Automation in Construction*, 17(4), 489–498.
- Zeinizadeh, H. (2017). Urban tourism in Tabriz, Iran: An analysis of the domestic tourism market. (Tesis Dr. Fal, Faculty of Arts & Social Science, Universiti Malaya, Malaysia). Diakses pada Oktober 12, 2022, daripada <http://studentsrepo.um.edu.my/7223/>
- Zuliskandar Ramli, Mazlin Mokhtar, Muhammad Rizal Razman & Sharifah Zarina Syed Zakaria. (2015). Pelancongan berasaskan warisan di Malaysia: Potensi dan cabaran. *Prosiding Seminar Antarabangsa Ke8: Ekologi, Habitat Manusia dan Perubahan Persekitaran*, Langkawi, Kedah, 21-22 September, hlm. 471-485.



Zina (Soal Jawab & Pertimbangan Akal): Analisis Ayat 32 Surah Al-Isra’ & Hadis Abu Umamah Al-Bahili

Mohd Zulkifli Bin Baharun
Fakulti Pendidikan Universiti Kebangsaan Malaysia
P113313@siswa.ukm.edu.my

Mohd Isa Hamzah
Fakulti Pendidikan Universiti Kebangsaan Malaysia
isa_hamzah@ukm.edu.my

ABSTRAK

Isu zina umpama barah dalam sistem pendidikan negara yang melanda kebanyakan golongan remaja di peringkat umur persekolahan. Justeru itu, semua pihak berkepentingan terutama pendidik, murid, ibu bapa dan komuniti seharusnya cakna dan proaktif terhadap segala usaha untuk menangani masalah ini. Penulisan ini dilakukan bagi tujuan menganalisis ayat 32 surah al-Isra’ dan hadis Abu Umamah Al-Bahili yang berkaitan permasalahan zina dan mencari formula serta prinsip penyelesaiannya berdasarkan sumber yang sahih iaitu al-Quran dan Sunnah. Kajian ini juga bertujuan mengenalpasti cadangan-cadangan pelaksanaannya dalam sistem pendidikan semasa agar tradisi kegemilangan keilmuan Islam zaman silam dapat terus diaplikasi dalam mendepani isu dan permasalahan dunia pendidikan hari ini. Kaedah kajian yang digunakan dalam penulisan ini adalah analisis kandungan terhadap kitab-kitab tafsir dan hadis, kajian-kajian ilmiah seperti tesis, jurnal-jurnal, dan kertas-kertas penyelidikan berbentuk seminar, prosiding dan pembentangan kertas kerja. Hasil analisis kajian, didapati beberapa konsep pendidikan yang boleh dijadikan rujukan seperti konsep pencegahan, konsep santuni, konsep soal jawab dan pertimbangan akal, serta konsep sentuhan dan doa. Kajian juga mendapati konsep utama iaitu soal jawab dan pertimbangan akal adalah suatu kaedah yang efektif dalam menangani isu sosial seperti zina serta cadangan aspek-aspek pelaksanaannya yang relevan dengan sistem pendidikan semasa.

Kata kunci: zina; gejala sosial; sumber Pendidikan Islam; soal jawab; pertimbangan akal

PENGENALAN

Pendidikan merupakan suatu proses pembinaan dan membentuk insan yang berilmu, beriman, berakhlak dan bermanfaat kepada masyarakat. Namun dalam proses ke arah tujuan tersebut usaha murni ini berhadapan dengan pelbagai isu pendidikan sama ada dalam kalangan murid mahu pun pihak yang terlibat secara langsung atau tidak langsung dengan pendidikan. Perbincangan kertas ini menumpukan analisis daripada sumber yang sahih iaitu al-Quran dan sunnah, berkaitan isu zina dan perkara-perkara yang membawa kepada zina. Masalah ini perlu dijadikan agenda utama negara kerana implikasinya kepada sistem pendidikan berkeupayaan merencanakan visi & misi yang digariskan Kementerian Pendidikan Malaysia (KPM). Penyelesaian melalui sumber yang sahih daripada Maha Pencipta & RasulNya sebagai utusan, telah menyediakan al-Quran sebagai manual dan panduan hidup yang menuntun pemahaman, penghayatan dan pengamalan secara komprehensif dalam kehidupan. Sementara sirah membuktikan metodologi sunnah menjadi solusi permasalahan ummah pada zaman jahiliyyah dan era kerajaan Islam di Mekah, Madinah dan kerajaan-kerajaan awal Islam seterusnya.

PENYATAAN MASALAH

Masalah sosial sering dikaitkan dengan remaja, ini kerana saban hari kita disajikan dengan berita pelbagai kes masalah sosial sehingga membawa kepada kes jenayah melibatkan golongan ini. Peringkat umur remaja merupakan cabaran yang besar kerana pelbagai perubahan yang dialami mereka termasuk dari segi mental dan fizikal(Wan Ramizah Hassan & Mohd Farid Ravi Abdullah, 2020). Mereka mula memberi reaksi terhadap perubahan tersebut dengan meneroka dan mencuba sesuatu yang baru sehinggakan sanggup melanggar norma-norma masyarakat, undang-undang dan agama(Nur Najwa Solehah et al., 2019). Tanpa bimbingan yang betul, mereka akan menjadi keliru untuk memilih gaya hidup dan hala tuju. Masalah dan isu yang difokuskan dalam penulisan ini ialah zina, perkara-perkara yang membawa kepada zina dan pengimplementasi konsep dalam sumber yang sahih untuk menanganinya.

Zina ini menyebabkan kes-kes jenayah yang lain seperti pembuangan bayi, sumbang mahram, pengguguran janin, kelahiran anak tak sah taraf dan sebagainya. Berdasarkan Statistik Polis Diraja Malaysia (PDRM sejumlah 577 kes pembuangan bayi bagi tahun 2014 sehingga 2018 direkodkan. Sementara hampir 100,000 kes remaja perempuan hamil bawah umur 19 tahun dilaporkan sejak 2013. Keadaan ini menunjukkan suatu angka yang membimbangkan dan perlu diberi perhatian serius oleh semua pihak. Sementara menurut sumber lain, terdapat kira-kira 900 kes pembuangan bayi dilaporkan bagi tempoh sama(Wan Ramizah Hassan & Mohd Farid Ravi Abdullah, 2020).

Selain daripada kes-kes yang menjadi implikasi kepada isu zina ini, kes-kes atau masalah yang mendorong kepada perzinaan ini juga menjadi isu dan masalah serius yang mengancam pembentukan anak-anak remaja terutamanya. Masalah ini yang menjadi antara isu dan masalah disiplin pelajar dalam dunia pendidikan sekian lama. Isu ini jika tiada perancangan penyelesaian yang sistematik dan efektif akan menggagalkan hasrat Falsafah Pendidikan Kebangsaan, Falsafah Pendidikan Islam dan aspirasi pendidikan negara. Antara kes-kes tersebut seperti pergaulan bebas, isu *couple*, khalwat, mendedahkan aurat, menyimpan, berkongsi dan melihat bahan berunsur porno atau video lucah dan sebagainya. Statistik dan data yang menunjukkan penglibatan dan pendedahan golongan remaja dengan bahan pornografi di internet sangat membimbangkan dan menjadi ancaman yang serius kepada pembentukan dan pembangunan modal insan yang bersepadu seperti dihasratkan. Kajian Nor Azrina et. al (2021) menyatakan Malaysia menduduki tangga ke-empat tertinggi di dunia mengikut statistik penggunaan trafik sesawang pornohub. Sebanyak 35.3% remaja Malaysia terdedah dengan bahan pornografi berdasarkan kajian Penduduk dan Keluarga Malaysia kelima (KPKM-5) oleh LPPKN (2014). Manakala kajian daripada BBC pada tahun 2020 menunjukkan peratusan yang tinggi berdasarkan kategori umur daripada 11 hingga 17 tahun iaitu penglibatan remaja dengan aktiviti pornografi(Nor Azrina et al., 2021).

Definisi & Jenis Zina

Zina merupakan perkara yang amat dilarang dalam Islam. Jumhur ulama' telah bersepakat hukum zina adalah haram. Menurut Imam Ahmad, dosa yang paling besar selepas dosa membunuh adalah dosa berzina (Wahbah al-Zuhaili 1997: 96). Perbuatan zina adalah dosa yang melibatkan seseorang dengan orang lain iaitu antara lelaki dan perempuan. Di dalam al-Quran Allah meletakkan perbuatan zina tersebut seiring dengan perbuatan membunuh. Hal ini menunjukkan bahawa perbuatan zina tersebut sangat besar dan keji di sisi Allah SWT.

Dalam hadis daripada sahabat Abu Hurairah r.a., bahawa Rasulullah s.a.w. bersabda:

عَنْ أَبِي هُرَيْرَةَ عَنْ النَّبِيِّ صَلَّى اللَّهُ عَلَيْهِ وَسَلَّمَ قَالَ كُتِبَ عَلَى ابْنِ آدَمَ نَصِيْبُهُ مِنْ
الزَّيْنَةِ مُدْرِكٌ ذَلِكَ لَا مَحَالَةَ فَالْعَيْنَانِ زَيْنَاهُمَا النَّظَرُ وَالْأُذُنَانِ زَيْنَاهُمَا الْإِسْتِمَاعُ وَاللِّسَانُ
زَيْنَاهُ الْكَلَامُ وَالْيَدُ زَيْنَاهَا الْبَطْشُ وَالرِّجْلُ زَيْنَاهَا الْحُطُّ وَالْقَلْبُ يَهْوَى وَيَتَمَنَّى وَيُصَدِّقُ
ذَلِكَ الْفَرْجُ وَيُكَذِّبُهُ

Maksudnya: *Ditetapkan atas anak cucu Adam bahagiannya dari zina akan diperoleh hal itu tidak mustahil. Kedua mata zinanya adalah memandang (yang haram). Kedua telinga zinanya adalah mendengarkan (yang haram). Lisan zinanya adalah berbicara (yang haram). Tangan zinanya adalah memegang (yang haram). Kaki zinanya adalah melangkah (kepada yang diharamkan). Sementara hati berkeinginan dan berangan-angan, sedang kemaluan yang membenarkan semua itu atau mendustakannya,*”

(Riwayat Muslim 4802).

Faktor Berlaku Zina

Perilaku dan tindakan yang menghakis jati diri dan identiti antaranya aktiviti ber'couple' yang telah pun dinormalisasikan dengan label seakan-akan 'Islamik', fesyen ala kebaratan, imej seksi serta penggunaan gajet yang meluas. Keadaan ini menggambarkan fitnah pada akhir zaman seperti yang pernah digambarkan oleh Rasulullah. Perkembangan teknologi maklumat juga jika digunakan tanpa batas dan adab syariat akan menyumbang kepada masalah pezinaan.

Kejahilan masyarakat terhadap ilmu berkaitan dosa zina seperti hokum, dosa dan akibat, faktor dan implikasi menyebabkan mereka mudah terpengaruh dengan dorongan hawa nafsu. Faktor didikan agama dan penghayatan agama seperti disiplin menunaikan solat tidak diambil berat sedangkan Allah telah memberi penegasan dalam al-Quran bahawa solat yang khushyuk berfungsi sebagai benteng diri daripada perkara dosa dan maksiat (Ma Razhanlaily & Salasiah Hanin Hamjah, 2017). Manakala dari perspektif lain pengaruh seperti media massa, rakan sebaya dan budaya asing banyak mempengaruhi pemikiran dan mencorak jati diri remaja kita. Pergaulan dan perhubungan antara berlainan jantina tanpa batas syarak membawa kepada kemungkaran lebih besar. Kelemahan sistem persekolahan dan pendidikan melalui peranan pentadbir, guru, ibu bapa dan komuniti tidak dapat dinafikan turut menjadi penyumbang penularan masalah ini.

Implikasi Zina Kepada Remaja & Sistem Pendidikan

Antara hadis yang popular ialah hadis riwayat al-Tabrani yang bermaksud “Sekiranya berleluasa perbuatan zina dan riba dalam sesuatu kawasan, maka mereka telah mengundang azab Allah kepada mereka. Dapat difahami di sini betapa besar musibah yang akan melanda apabila berleluasanya zina. Dosa zina ini juga mengundang seribu macam masalah disiplin dan sosial dalam kalangan remaja (Wan Ramizah Hassan & Mohd Farid Ravi Abdullah, 2020). Keadaan ini boleh dilihat berdasarkan realiti kes yang berlaku dalam sistem pendidikan kita, di mana kebanyakan remaja yang terlibat dengan budaya 'boyfriend dan girlfriend' ini akan berkait dengan kesalahan lain seperti, khalwat, menyimpan dan melihat bahan lucah, ponteng sekolah dan yang paling parah melahirkan anak luar nikah.

Implikasi daripada keadaan ini menyebabkan peningkatan statistik pelajar yang keciciran dan kemerosotan dalam pelajaran akhirnya menjejaskan matlamat sistem pendidikan kita. Di samping itu, dari sudut kesihatan, zina ini juga menyebabkan munculnya pelbagai penyakit seperti sifilis, aids dan sebagainya yang menyebabkan kerugian kepada negara dari

aspek modal insan dan kos kewangan. Kelahiran anak tidak sah taraf dan kepincangan yang berlaku dalam institusi keluarga menjejaskan keharmonian dan kesejahteraan masyarakat, ini kerana keluarga yang sejahtera asas kepada negara sejahtera (Nur Najwa Solehah et al., 2019).

TAFSIR AYAT & HURAIAN HADIS

﴿وَلَا تَقْرُبُوا الزِّنَىٰ إِنَّهُ كَانَ فَحِشَةً وَسَاءَ سَبِيلًا ۝٣٢﴾

32. “Dan janganlah kamu mendekati zina, (zina) itu sungguh suatu perbuatan keji, dan suatu jalan yang buruk.”
(Surah Al-Isra’ ayat 32)

Ibnu Qayyim 2007

Allah s.w.t. telah menerangkan tentang kejinya zina kerana kalimah faahisyah bermaksud perbuatan keji atau kotor yang sudah mencapai tingkat yang tinggi dan diakui kekejiannya oleh setiap yang berakal, zina juga disifatkan adalah seburuk-buruk jalan kerana merupakan jalan membawa pelaku kepada kebinasaan, kehancuran dan kehinaan dunia dan azab di akhirat.

Tafsir al-Azim (5/72)

Berkata Ibn Kathir dalam Tafsir-nya bahawa Allah melarang para hamba-Nya daripada melakukan zina dan juga perkara yang mendorong kepada zina seperti punca-punca dan seruan-seruannya.

Tafsir Munir

Menurut Syaikh Wahbah Az Zuhaili, faahisyah (فاحشة) adalah perbuatan yang sangat keji. Sedangkan saa’a sabiilaa (ساء سبيلا) adalah jalan yang sangat buruk sebagai akibat pelanggaran terhadap kehormatan keturunan yang mengakibatkan tercampur dan terputusnya nasab serta mengakibatkan kepincangan dalam institusi masyarakat.

Tafsir Jalalain

Dalam Tafsir Jalalain Juz 1/hal. 230 menghuraikan penggunaan kata “taqrobu” memiliki makna lebih tegas daripada lafadz “ta’tuu “. Yang dimaksud, larangan dalam ayat ini tidak menggunakan kata “jangan lakukan zina “, sebaliknya “jangan hampiri zina “

Matan Hadis

عَنْ أَبِي أُمَامَةَ الْبَاهِلِيِّ رَضِيَ اللَّهُ تَعَالَى عَنْهُ قَالَ إِنْ فَتَى شَابًا أَتَى النَّبِيَّ صَلَّى اللَّهُ عَلَيْهِ وَسَلَّمَ فَقَالَ يَا رَسُولَ اللَّهِ ائْتِدُنْ لِي بِالزَّيْنَاءِ. فَأَقْبَلَ الْقَوْمُ عَلَيْهِ فَرَجَرُوهُ قَالُوا مَهْ مَهْ فَقَالَ أَذُنُهُ فِدَانًا مِنْهُ قَرِيبًا قَالَ فَجَلَسَ قَالَ أَتُحِبُّهُ لِأُمَّتِكَ؟ قَالَ لَا وَاللَّهِ جَعَلَنِي اللَّهُ فِدَاءَكَ. قَالَ وَلَا النَّاسُ يُحِبُّونَهُ لِأُمَّتِهِمْ. قَالَ أَفَتُحِبُّهُ لِابْنَتِكَ؟ قَالَ لَا وَاللَّهِ يَا رَسُولَ اللَّهِ جَعَلَنِي اللَّهُ فِدَاءَكَ. قَالَ وَلَا النَّاسُ يُحِبُّونَهُ لِأُمَّتِهِمْ. قَالَ أَفَتُحِبُّهُ لِأَخَوَاتِكَ؟ قَالَ لَا وَاللَّهِ جَعَلَنِي اللَّهُ فِدَاءَكَ. قَالَ وَلَا النَّاسُ يُحِبُّونَهُ لِأُمَّتِهِمْ. قَالَ أَفَتُحِبُّهُ لِخَالَاتِكَ؟ قَالَ لَا وَاللَّهِ جَعَلَنِي اللَّهُ فِدَاءَكَ. قَالَ وَلَا النَّاسُ يُحِبُّونَهُ لِأُمَّتِهِمْ. قَالَ فَوَضَعَ يَدَهُ عَلَيْهِ وَقَالَ: اللَّهُمَّ اغْفِرْ ذَنْبَهُ وَطَهِّرْ قَلْبَهُ وَحَصِّنْ فَرْجَهُ فَلَمْ يَكُنْ بَعْدَ ذَلِكَ الْقَتْلَى يَلْتَمِثُ إِلَى شَيْءٍ. (أحمد 21185)

Diriwayatkan daripada Sayyidina Abu Umamah Al Bahili r.a., sesungguhnya seorang pemuda datang menemui Nabi ﷺ lalu dia berkata: “Wahai Rasulullah, izinkan daku untuk melakukan perzinaan”, lalu semua kaum yang berada di situ menuju kepadanya dan mengherdikanya sambil berkata: “Hentikanlah (permintaanmu itu). Hentikanlah!”

Lalu Baginda bersabda: “Hampirkanmya padaku”, lalu pemuda itu menghampiri Baginda dan diminta untuk duduk, Rasulullah lantas bersabda: “Adakah kamu suka jika ia(zina) berlaku pada ibumu?” Jawabnya: “Tidak! Demi Allah, wahai Rasulullah dan (semoga Allah menjadikan diriku sebagai tebusanmu) – lafaz sumpah,” “Demikianlah manusia yang lain juga tidak menyukai perkara yang keji ini berlaku kepada ibu-ibu mereka.”

Rasulullah bertanya lagi: “Adakah kamu suka ia(zina) berlaku pada anak perempuanmu?” Jawabnya: “Tidak! Demi Allah, wahai Rasulullah.” “Demikianlah manusia yang lain, mereka juga tidak menyukai perkara yang keji ini berlaku kepada anak-anak perempuan mereka.”

Kemudian diringkaskan hadis di sini, Rasulullah bertanya soalan dan berlaku soal jawab yang sama tentang pandangan lelaki tersebut jika zina menimpa saudara perempuan dan ibu saudaranya sama ada sebelah ibu dan ayah.

Kata Sayyidina Abu Umamah: Rasulullah meletakkan tangan Baginda yang mulia ke atas pemuda tersebut lantas berdoa:

اللَّهُمَّ اغْفِرْ ذَنْبَهُ وَطَهِّرْ قَلْبَهُ وَخَصِّنْ فَرْجَهُ

“Ya Allah, ampunkan dosanya, sucikan hatinya dan peliharalah kemaluannya (daripada maksiat).”

Sayyidina Abu Umamah berkata lagi: Pemuda itu tidak lagi berkeinginan untuk melakukan perkara terkutuk selepas itu. (Riwayat Ahmad)

Huraian Hadis

Nabi menyantuni seorang pemuda yang telah mengalami masalah kecenderungan melakukan zina, dengan itu, Nabi menghilangkan kebiasaan buruk itu melalui cara dialog dan merangsang pertimbangan akalnya tanpa membacakan ayat Al-Qur’ān yang menyatakan keharaman zina dan ancaman bagi pezina lelaki mahupun perempuan. Berdasarkan Nabî, pendekatan ini lebih berkesan pada saat itu sebagai usaha untuk menghentikan tabiat buruk yang dilakukan pemuda itu sesuai daya pengetahuan dan kemampuannya. Justeru, para da’ie, guru dan pendidik, dalam keadaan tertentu digalakkan untuk mengaplikasikan kaedah pertimbangan akal ini terhadap orang-orang tertentu yang menjadi sasaran dakwah.

Konsep-Konsep Berdasarkan Sumber

Wahyu Allah dan Sunnah Rasul dalam bentuk formula, prinsip yang lebih umum, menjadi tanggungjawab kita untuk mencari penyelesaian dan pendekatan yang lebih spesifik, kreatif dan relevan dengan keperluan semasa. Antara konsep-konsep yang dapat dikaitkan dan diberi penekanan dalam penulisan ini adalah seperti konsep pencegahan, konsep santuni, konsep soal jawab & konsep pertimbangan akal, konsep sentuhan & doa yang akan diperincikan berikutnya.

IMPLEMENTASI KONSEP SUMBER DALAM PENDIDIKAN

Implementasi dalam Pembelajaran dan Pemudah Caraan

Konsep Pencegahan

Konsep Pendidikan Pencegahan perlu diperkasakan di semua peringkat iaitu sekolah, PPD, JPN, PIBG dan Sarana melalui pelbagai program yang dekat dengan jiwa murid seperti, seminar, motivasi, kem bina insan, forum, syarahan agama, pertandingan berunsurkan mesej keagamaan dan sebagainya. Apa sahaja program atau aktiviti pendidikan yang dilaksanakan di pelbagai peringkat khususnya di sekolah hendaklah berteraskan konsep pencegahan, kerana mencegah itu lebih baik daripada merawat. Jika sudah menjadi barah dan penyakit sudah semestinya memerlukan usaha dan kos yang berlipat ganda untuk menyelesaikannya. Justeru, adalah suatu langkah bijak dan berpandangan jauh untuk menumpukan konsep ini kepada pengimplementasinya secara komprehensif, kreatif, inovatif, konsisten dan berfokus kepada sesuatu isu. Sebagai contoh, isu zina konsep pencegahan ini boleh diaplikasi dalam pelbagai pendekatan seperti program, aktiviti, kempen dan budaya sekolah. Kempen menutup aurat, kempen kata kan tidak pada pergaulan bebas, zina dan sebagainya, begitu juga pertandingan berbentuk permainan atau kuiz yang bertemakan pencegahan kepada zina dan perkara yang mendorong kepada zina di laksanakan untuk mendidik dan memberi kesedaran kepada murid tentang implikasi zina.

Konsep Soal Jawab dan Pertimbangan Akal

Kaedah soal jawab diperkasa lagi iaitu berdasarkan topik yang ada dalam sukatan pelajaran, lebih terarah dan berpandu bagi merangsang pertimbangan akal. Guru perlu merancang, membina dan menstruktur teknik soal jawab berdasarkan objektif pembelajaran topik yang diajar. Hal ini demikian, setiap pengajaran yang disampaikan guru berpotensi untuk mengoptimalkan penghayatan dan pengamalan murid tentang apa yang dipelajari dalam kehidupan sosial mereka. Soal jawab berstruktur ini disesuaikan dengan kemahiran berfikir aras tinggi berdasarkan pengintegrasian teori Islam dan Barat. Usaha dan pendekatan berteraskan konsep ini seharusnya diperluaskan jaringannya dalam pelbagai platform seperti Komuniti Pembelajaran Professional (KPP) atau *Professional Learning Community* (PLC), dialog prestasi, wacana, bengkel dan sebagainya sebagai sebahagian strategi meningkatkan kompetensi guru dalam membentuk sahsiah anak-anak didik konsisten dengan aspirasi murid (PPPM 2013-2025).

Konsep Santuni dan Konsep sentuhan & doa

Kaedah ini boleh diaplikasikan di dalam kelas atau dalam apa-apa situasi ketika berhadapan pelbagai kesalahan sama ada kecil atau besar yang melibatkan murid. Sebagai pendidik sudah menjadi lumrah dalam dunia pendidikan berhadapan dengan pelbagai situasi yang melibatkan isu disiplin, akhlak dan moral murid. Dalam isu seperti kajian ini iaitu isu zina dan perkara-perkara yang berkaitan merupakan isu yang besar dan memberi impak negatif yang besar kepada anak didik khususnya dan matlamat sistem pendidikan amnya. Kerosakan anak-anak remaja akibat zina ini membawa kepada rosaknya pelapis generasi warganegara yang berpotensi untuk mencapai kesejahteraan dan keharmonian masyarakat dan negara. Di bawah konsep ini boleh diperincikan lagi pelaksanaannya. Sebagai contoh, walau sebesar mana pun masalah disiplin dan akhlak di kalangan murid dan walau serumit mana pun situasi melibatkan salah laku murid, jangan sesekali para guru atau pendidik bertindak mengikut emosi, sebaliknya

pendekatan menyantuni murid melalui pelbagai strategi yang kreatif hendaklah dirancang dan diimplementasi dengan harapan berupaya menyentuh hati dan menagsang gaya berfikir murid yang lebih positif.

Manakal kaedah sentuhan atau *body contact* sudah dipraktikkan dalam amalan pengajaran guru begitu juga amalan doa untuk murid, namun pendekatan kombinasi serentak doa & sentuhan amat kurang dan hampir tiada dipraktikkan. Konsep daripada metodologi sunnah ini yang dipandang biasa dan jarang dipraktikkan dalam amalan pengajaran guru ini seharusnya diperkasakan dalam bentuk yang lebih kreatif dan terkini. Konsep ini juga hendaklah dijadikan agenda penting dalam setiap sesi libat urus warga pendidikan di setiap peringkat agar dapat menghidupkan amalan kualiti terbaik pengajaran berpaksikan sumber yang sah.

Implementasi dalam Kurikulum & Bahan Bantu Pembelajaran

Kurikulum

Konsep-konsep umum daripada sumber yang dipilih perlu diperincikan dari segi pelaksanaan, pendekatan dan pentaksirannya dalam dokumen rasmi kurikulum sebagai panduan guru yang menjadi golongan pelaksana. Hal ini akan membantu para pendidik dalam penyampaian kurikulum semasa PdPc. Pihak yang berautoriti seperti Kementerian Pendidikan Malaysia (KPM), Unit Kurikulum, Jawatankuasa Induk Kurikulum, pakar-pakar pendidikan, penerbit buku, pendidik dan aktivis perlu memberi idea dan input pelaksanaan konsep dengan terperinci. Elemen-elemen konsep dari sumber ini juga boleh diselitkan dan diwujudkan ruang khusus dalam buku teks dan modul atau pembentuk dan pembinaan modul khusus berasaskan setiap konsep. Seterusnya pendekatan dan pelaksanaan konsep-konsep berkaitan disebarluaskan kepada semua peringkat dan lapisan warga dan pihak yang berkepentingan bagi menjadikannya satu amalan pengajaran dan pembelajaran yang berkualiti.

Bahan Bantu Pembelajaran

Konsep-konsep yang diambil dari sumber yang dipilih di aplikasikan dalam bahan-bahan bantu pembelajaran seperti buku teks, modul, video, bahan interaktif, medium medsos, bahan mautud dalam kelas dan persekitaran sekolah.

HURAIAN KONSEP SUMBER BERDASARKAN 3 DOMAIN

Domain Kognitif, Afektif dan Psikomotor

Berdasarkan konteks sumber ayat, Allah mendidik kita agar menjauhi perkara-perkara yang membawa kepada zina melalui maksud tersirat. Allah juga mendidik kita bahawa untuk mengelakkan sesuatu kemudaratan dan keburukan agar mendapatkan pengetahuan dan menyelidiki segala aspek yang berkaitan.

Sementara sumber hadis, Rasulullah mendidik kita agar berfikir lebih daripada satu dimensi atau perspektif tentang sesuatu tindakan yang kita hendak ambil. Kita tidak seharusnya berfikir untuk kepuasan dan keseronokan yang bersifat sementara, akibatnya meninggalkan keburukan yang besar dan berpanjangan. Rasulullah juga mendidik kita bahawa fitrah manusia sayang akan keluarga dan tidak suka terhadap keburukan yang menimpa kepada keluarga. Rasulullah memberi pelajaran kepada kita untuk menyantuni mad'uu atau murid walau sebesar mana kesalahan mereka. Di samping itu, pengajaran yang sangat bermanfaat

yang dapat diambil daripada sumber bahawa disebalik segala usaha dan pendekatan kita, doa adalah usaha terakhir sebagai kekuatan mukmin.

Pendidikan Rabbani dan Sunnah Rasul menunjukkan kepada kita pertimbangan akal membawa kepada terbitnya emosi dan sikap. Allah menggambarkan zina adalah perkara keji dan seburuk-buruk jalan agar menimbulkan kesedaran (emosi). Sementara itu, Rasulullah memberi reaksi di luar norma menimbulkan kesedaran bahawa tindakan agresif bukan penyelesaian terbaik sesuatu permasalahan.

Gaya bahasa wahyu merangsang daya fikiran manusia dan menimbulkan emosi, sikap dan nilai seterusnya membentengi diri daripada segala perkara yang membawa kepada zina. Konsep santuni dan Konsep Reaksi luar norma melatih diri untuk mengawal emosi dan menggunakan kemahiran komunikasi dengan hikmah. Rasulullah memberi pendidikan yang boleh diaplikasikan sebagai teknik dalam proses kaunseling/Psikologi.

RUMUSAN/ PENUTUP

Pendidikan bersumberkan al-Quran dan Sunnah Rasul adalah komprehensif dalam menghadapi dan menyelesaikan segala isu samada aspek pendidikan, ekonomi, politik, agama, sosio budaya dan nilai. Dalam konteks Isu zina dan segala isu yang membawa kepada zina seperti budaya *couple*, pergaulan bebas di sekolah, menyimpan dan melihat bahan lucah, tidak menutup aurat dan sebagainya perlu diberi perhatian serius melalui pendekatan kreatif berasaskan sumber yang sah. Hal ini demikian kerana sumber sah keilmuan ketamadunan Islam telah membuktikan berjaya menyelesaikan dan mentransformasikan permasalahan manusia dalam pelbagai aspek. Sesungguhnya, formula dan prinsip umum yang ada dalam sumber-sumber sah keilmuan Islam perlu dikaji, diteliti, dibincangkan, diperincikan dalam pelaksanaan dan pendekatan yang lebih kreatif, segar, dinamik dan relevan dengan keperluan semasa.

RUJUKAN

- Ahmad Muhammad Syakir. *Al Musnad Imam Ahmad Bin Hanbal*. Darul Hadis. Kaherah. 164-241 H
- Al-Zuhaili, Wahbah, (1997). *Al-Fiqh al-Islami wa Adillatuh* Jilid IV. Dar Al-Fikr, Damaskus
- Badir Muhammad Badir. 1413H. *Manhaj Sunnah Nabawiyyah Fi Tarbiyyah Insan*. Maktabah Da'wah Islamiyyah Mansurah.
- Fitrah Sugiarto. (2021). *Hadis-Hadis Tarbawi (Takhrij dan Analisis Sanad)*. UIN Mataram Press. ISBN : 978-623-98882-0-6. p 97-101
- Ibn Kathir, Imad al-Din. (2000). *Tafsir al-Qur'an al-Azim, Tahqiq: Mustafa al-Sayyid Muhammad et.al.* Kaherah, Muassasah Qurtubah
- Ibnu Qayyim al-Jauziyah. (2007). *Bahaya Zina, Terj. Tim Darul Haq*, Maktab Dakwah dan Bimbingan Jaliyat Rabwah, Jakarta.
- Imam Jalaluddin As-Suyuti. (2003). *Tafsir Jalalain versi Terjemahan Melayu oleh Bahrin Abu Bakar*. Sinar Baru Algensindo, Bandung, Indonesia
- Ma Razhanlaily, & Salasia Hanin Hamjah. (2017). Faktor zina dan kesannya dalam kehidupan remaja. *Sains Insani*, 2(2), 1–9.
- No Azrina, Tengku Maaidah, Nik Nurul Akmal, Nur Kamilah, Najahudin Lateh, & Nurhidayah. (2021). Pornografi dalam kalangan remaja generasi z menurut perspektif islam. *Research in Islamic Studies*, 8(2), 67–78.
- Nur Najwa Solehah, Siti Norhafiza Sumadi, Nur Aqilah Salleh, Naziera Izzaty Ismail, Nurul Ain Haayati, & Mohd Razimi Husin. (2019). Masalah pergaulan bebas dalam kalangan remaja sekolah. *International Journal of Humanities, Management and Social Science*, 2(1), 38–50. <https://doi.org/10.36079/lamintang.ij-humass-0201.21>

Wan Ramizah Hassan, & Mohd Farid Ravi Abdullah. (2020). Menangani masalah zina menurut perspektif al-Quran dan Sunnah. *The Sultan Alauddin Sulaiman Shah Journal (JSASS)*, 7(1), 49–63. <http://jsass.kuis.edu.my/index.php/jsass/article/view/13>
<https://bincangsyariah.com/kalam/tafsir-surah-al-isra-ayat-32-makna-jangan-dekati-zina/>[17 Mei 2022]
<http://www.addeen.my/index.php/rohani/al-quran/item/3-nabi-izinkan-aku-berzina>[17 Mei 2022]
<https://www.dream.co.id/your-story/tafsir-surat-al-isra-ayat-32-larangan-umat-mendekati-zina-210112h.htm>[17 Mei 2022]



UNIVERSITI
MALAYSIA
KELANTAN

Faktor Dominan dalam Mempengaruhi Kecenderungan Sokongan Nelayan dalam PRU-15

Norria Zakaria
Universiti Utara Malaysia
norria@uum.edu.my

Mohamad Zaki Ahmad
Universiti Utara Malaysia
zaki.ahmad@uum.edu.my

Malike Brahim
Universiti Utara Malaysia
malike@uum.edu.my

ABSTRAK

Suatu kajian tinjauan telah dijalankan untuk menilai kecenderungan sokongan kepada kerajaan dalam pilihan raya umum ke-15. Kecenderungan sokongan itu diukur menggunakan pembolehubah seperti dasar dan program bantuan kerajaan; langkah kerajaan memajukan ekonomi rakyat; pengaruh media massa; kualiti hidup; dan prestasi wakil rakyat (pemimpin). Penentuan kecenderungan sokongan nelayan berdasarkan kepada interpretasi 3 (tiga) skala yang digunakan. Jika nilai min minimum 1.66 dan ke bawah, ia dinilai sebagai tidak menyokong kerajaan (hitam) dan nilai min minimum 2.34 dan ke atas dinilai sebagai menyokong kerajaan (putih). Sebaliknya, jika nilai min antara 1.67 (minimum) hingga 2.33 (maksimum) dinilai sebagai sokongan berbelah bahagi (kelabu). Analisis dapatan kajian menunjukkan nelayan cenderung menyokong kerajaan apabila semua pembolehubah menunjukkan nilai min melebihi 2.5 dan ke atas. Faktor paling dominan mempengaruhi kecenderungan sokongan nelayan iaitu indeks kualiti hidup dengan nilai min 2.7657. Namun, pembolehubah prestasi wakil rakyat (pemimpin) mencatatkan nilai min terendah (2.5264) yang diramal mampu mempengaruhi sokongan nelayan kepada wakil rakyat sedia ada dalam pilihan raya umum ke-15. Atas sebab itu, wakil rakyat perlu meningkatkan kualiti perkhidmatan dan prihatin terhadap segala masalah rakyat di kawasan pilihan raya masing-masing.

PENGENALAN

Jika diteliti pelbagai dokumen bercetak dan elektronik, sebenarnya telah banyak memaparkan tulisan, ulasan, kajian, analisis dan liputan tentang masyarakat nelayan di Malaysia. Bahkan dalam beberapa siri Rancangan Lima Tahun Malaysia, nasib masyarakat nelayan sentiasa diberi perhatian oleh pihak kerajaan. Oleh itu, tanggungjawab bagi menyampaikan perkhidmatan terbaik masyarakat nelayan adalah menerusi Kementerian Pertanian dan Industri Makanan (MAFI) bersama agensi utamanya seperti Jabatan Perikanan Malaysia (DOFM) dan Lembaga Kemajuan Ikan Malaysia (LKIM) di seluruh negara dengan kerjasama Persatuan Nelayan Kawasan (PNK) masing-masing.

Pada umumnya, nelayan antara kumpulan masyarakat dalam negara yang sentiasa mendapat perhatian serius oleh kerajaan melalui pelaksanaan pelbagai dasar dan program bantuan yang disalurkan menerusi agensi-agensi di atas atau lain-lain agensi. Bahkan kerjasama yang baik antara MAFI dengan kerajaan negeri memudahkan urusan pelaksanaan dasar dan menyalurkan program bantuan kepada masyarakat nelayan. Hal ini telah dibuktikan

oleh Mohamad Hussin (2018) yang melaporkan kerajaan telah melancarkan Gelombang Nelayan Nasional (GNN) 2018 sebagai sebuah program berbentuk aktiviti turun padang dan ramah mesra membabitkan kerjasama antara sektor kerajaan, swasta serta nelayan. Objektif utama program GNN dianjurkan sebagai medium penyaluran maklumat tentang dasar kerajaan dan penyampaian perkhidmatan oleh jabatan dan agensi kerajaan kepada masyarakat nelayan. Dalam usaha itu, LKIM diberi tanggungjawab untuk memperbaiki kedudukan sosio-ekonomi nelayan dengan penumpuan kepada peningkatan pendapatan dan memajukan perusahaan perikanan negara serta menjaga kebajikan sosial dan ekonomi masyarakat nelayan.

Rusnan Mustafa (2017) menjelaskan pelbagai dasar dan program dirangka bagi membela nasib nelayan di Malaysia. Peranan itu diletakkan di bawah LKIM dan Jabatan Perikanan untuk menangani isu melibatkan kehidupan nelayan di negara ini. Semua dasar dan program yang dilaksanakan demi masyarakat nelayan membuktikan komitmen kerajaan dalam memastikan kesejahteraan masyarakat nelayan sentiasa menjadi keutamaan. Antara dasar semasa yang dilaksanakan secara langsung kepada masyarakat nelayan seperti pemberian elaun sara hidup (ESH) berjumlah RM200 pada tahun 2015 dan ditambah kepada RM300 pada tahun 2016.

Selain itu, kerajaan turut menyediakan sejumlah peruntukan bagi tujuan Projek Khas Perumahan Nelayan (PKPN) yang merangkumi program baik pulih dan bina rumah supaya kehidupan masyarakat nelayan lebih selesa. Bahkan kerajaan telah menyalurkan banyak bantuan kepada masyarakat nelayan di seluruh negara menerusi Projek AZAM Tani; Program Basmi Kemiskinan Nelayan; Program Peningkatan Pendapatan Nelayan; Program Transformasi Nelayan; Program Pasar Nelayan; dan pembinaan Kompleks Pendaratan Ikan.

Dalam pada itu, fokus kerajaan ke arah membantu masyarakat nelayan tidak sahaja berkisar kepada aktiviti berkaitan penangkapan ikan semata-mata. Atas sebab itu, kerajaan sentiasa ingin melihat masyarakat nelayan boleh keluar dari kepompong kemiskinan dan tidak bergantung kepada bantuan dan subsidi kerajaan dan musim tangkapan ikan sahaja. Dengan kata lain, nasib dan rezeki nelayan tidak boleh lagi bergantung kepada satu sumber pendapatan sahaja, tetapi perlu ada sumber pendapatan kedua. Justeru, kerajaan telah menggalakkan nelayan supaya meneroka bidang perusahaan makanan halal yang berasaskan ikan seperti menghasilkan keropok ikan, burger ikan atau makanan sejuk beku berasaskan ikan.

Namun, tidak pernah dijangka sama sekali apabila negara berhadapan dengan Pandemik Covid-19 yang menggesa kerajaan menguatkuasakan Perintah Kawalan Pergerakan (PKP). PKP itu secara langsung telah menjejaskan aktiviti masyarakat nelayan dan membebankan mereka apabila mengalami masalah kewangan dan hilang mata pencarian buat seketika. Namun, kerajaan tidak pernah mengabaikan nasib nelayan apabila pelbagai dasar dan program bantuan telah dilaksanakan sama ada sebelum dan semasa tempoh PKP (Junhairi Alyasa, 2020).

Walau bagaimanapun, kerajaan melalui pelbagai dasar dan program bantuan terus memberi tumpuan kepada masyarakat nelayan seperti mana kumpulan masyarakat lain dalam negara yang layak menerima bantuan dan subsidi daripada kerajaan. Ini semua bertujuan meringankan beban dan menyelesaikan serba sedikit masalah yang dihadapi oleh setiap isi rumah nelayan di negara ini (Zanariah & Nor Azizah, 2020).

LATAR BELAKANG KAJIAN

PKP secara umumnya telah menjejaskan seluruh aktiviti sosio-ekonomi di negara ini, di mana rangkaian aktiviti yang berkait antara satu sama lain telah memberi kesan besar kepada majoriti rakyat. Apabila PKP dikuatkuasakan, ia secara tidak langsung telah memberi kesan kepada sektor perikanan dan seterusnya masyarakat nelayan di Malaysia. Walaupun ada bantuan dan dasar yang dilaksanakan khusus kepada masyarakat nelayan, tetapi ianya tidak boleh menangani setiap masalah dan kesulitan yang dihadapi. Oleh sebab itulah, kajian ini dijalankan bertujuan menilai impak keberkesanan dasar dan program bantuan kerajaan kepada masyarakat nelayan di negara ini, dan pada masa yang sama turut berusaha meneliti kecenderungan sokongan nelayan sama ada berpihak kepada kerajaan semasa atau sebaliknya.

PERMASALAHAN KAJIAN

Nelayan adalah suatu kumpulan masyarakat yang kehidupan mereka bergantung secara langsung kepada hasil laut sama ada melalui aktiviti penangkapan ikan atau lain-lain proses berkaitan dengan pengeluaran pelbagai produk berasaskan ikan. Pada umumnya, kumpulan ini tinggal di kawasan pinggir atau pesisir pantai yang lazimnya bermukim dalam lingkungan yang berdekatan dengan lokasi kegiatannya. Jadi, rutin harian mereka berkisar dalam ruang atau zon dengan aktiviti yang hampir sama.

Kehidupan nelayan sinonim dengan kemiskinan dan kumpulan yang berpendapatan rendah. Justeru, nelayan merupakan kumpulan dalam masyarakat yang banyak menerima bantuan dan subsidi daripada kerajaan. Disebabkan kemiskinan, menurut Muhammad Rafi, Sharifah Rohayah dan Sofia Haminah (2019), komuniti nelayan mempunyai lima cabaran hidup iaitu kesukaran menampung perbelanjaan harian; kesukaran melanjutkan pendidikan; kesukaran memiliki aset; keperluan melakukan pekerjaan sampingan; dan ancaman gejala sosial. Walaupun masyarakat nelayan antara komuniti minoriti yang wujud di Malaysia, tetapi mereka mempunyai peranan yang signifikan dalam ekonomi negara. Hayrol Azril, *et. al.* (2011) menjelaskan bahawa sumbangan nelayan ke atas ekonomi tidak dapat disangkal, di mana rakyat di negara ini bergantung kepada nelayan untuk mendapatkan sumber protein berasaskan sumber laut.

Walaupun pekerjaan di sektor perikanan di Malaysia tidak terjamin dan kadar pendapatan tidak menentu kerana ia banyak bergantung kepada musim penangkapan ikan dan keadaan cuaca, tetapi ada yang bekerja sebagai nelayan sudah turun temurun—dari satu generasi ke satu generasi—sebagai nelayan laut dalam atau pesisir pantai. Ada yang menjadi nelayan dengan memiliki segala peralatan dan kemudahan tangkapan ikan sendiri. Sebaliknya, tidak kurang pula yang bekerja dengan majikan. Apa yang pasti pendapatan atau rezeki nelayan tidak konsisten kerana bergantung kepada cuaca dan keadaan laut. Ada ketikanya mereka memperolehi pendapatan lumayan dan ada ketikanya pulang dengan tangan kosong. Lebih teruk lagi, mereka terpaksa berhutang untuk meneruskan hidup terutama ketika musim tengkujuh. Dalam tempoh PKP, kumpulan ini sangat terjejas dari segi punca pencarian dan pendapatan.

Disebabkan bekerja sebagai nelayan tidak memberi jaminan bahawa kehidupan mereka menjadi senang dan kaya-raya pada masa hadapan, tetapi itu sahaja pilihan yang mereka ada kecuali terdapat pelbagai insentif dan alternatif lain yang disediakan oleh kerajaan kepada mereka.

Apabila negara dilanda Pandemi Covid-19, masyarakat nelayan sangat terjejas terutama nelayan awak-awak dan nelayan yang memiliki keupayaan peralatan tangkapan yang kecil dan terhad. Keadaan ini menyebabkan pendapatan dan sumber ekonomi harian mereka terhenti disebabkan kapal atau bot tidak dibenarkan beroperasi. Aktiviti ekonomi sampingan seperti berjual, mengusahakan produk berasaskan perikanan dan lain-lain juga tidak dapat dijalankan pada ketika itu. Jadi, bagi membela nasib kumpulan nelayan, kerajaan telah melaksanakan banyak dasar dan program agar nelayan dapat meneruskan kelangsungan hidup seperti kumpulan masyarakat yang lain.

Selain itu, sebelum dan semasa PKP, kerajaan sebenarnya sangat prihatin dan peka dengan nasib masyarakat nelayan. Hal ini dapat diteliti menerusi beberapa dasar dan program bantuan yang telah dilaksanakan oleh kerajaan kepada nelayan. Dari segi bantuan, kerajaan telah mengeluarkan peruntukan dalam jumlah yang sangat besar. Jadi, nasib nelayan terus mendapat perhatian termasuklah dalam kalangan wakil rakyat. Misalannya kerajaan persekutuan telah melaksanakan banyak bantuan khusus untuk meningkatkan ekonomi nelayan tradisional yang disediakan melalui MAFI, DOFM dan LKIM. Contohnya, MAFI telah menyediakan dana sebagai Geran Agropreneur Muda 2019. Program ini diwujudkan dalam pelaksanaan Rancangan Malaysia ke-11 untuk golongan muda yang berumur di antara 18 hingga 40 tahun untuk terlibat dalam bidang keusahawanan agro berasaskan semua aktiviti di dalam rantai nilai sektor pertanian seperti tanaman, ternakan, perikanan, industri asas tani termasuk pemasaran, khidmat sokongan dan agropelancongan. Di samping itu, nelayan juga diberi bantuan seperti enjin, sampan, peralatan navigasi dan peralatan menangkap ikan. Sementara itu, LKIM turut menyediakan bantuan kepada nelayan seperti subsidi minyak diesel dan petrol; insentif tangkapan ikan; insuran nelayan; perumahan nelayan; dan lain-lain.

Dalam pada itu, hampir kebanyakan kerajaan negeri telah menyediakan bantuan seperti Program Bantuan Nelayan, Petani dan Penternak. Pada tahun 2018, negeri Selangor telah menyediakan peruntukan ke Pejabat Perikanan Negeri Selangor untuk membantu penternak dan nelayan. Antara bantuan yang telah disalurkan adalah peralatan untuk ternakan akuakultur seperti pam, tangki ternakan dan makanan ikan. Nelayan juga diberi bantuan peralatan menangkap ikan, di mana tahun 2018 sebanyak RM275,000.00 telah dikeluarkan oleh kerajaan negeri Selangor bagi tujuan tersebut. Bagi negeri Kelantan pula, kerajaan telah mengeluarkan sebanyak RM900,000 bagi membantu nelayan yang berdaftar dengan Jabatan Perikanan Negeri Kelantan dan LKIM semenjak PKP dikuatkuasakan.

Maklumat di atas memberi petunjuk bahawa begitu besar peruntukan kerajaan kepada nelayan. Namun, sejauhmanakah bantuan yang diberikan oleh kerajaan mampu mengubah kehidupan nelayan? Secara umumnya keadaan nelayan tidak banyak berubah walaupun bantuan demi bantuan diberikan oleh kerajaan khususnya melalui LKIM. Dari segi kualiti hidup dan pendapatan, boleh dikatakan majoriti nelayan masih terus bergantung kepada bantuan dan subsidi kerajaan. Ternyata, dengan bantuan dan subsidi kerajaan kepada masyarakat nelayan yang agak signifikan, sedikit sebanyak menggerakkan hati kerajaan untuk mengetahui faktor yang berkaitan yang mempengaruhi kecenderungan sokongan nelayan dalam PRU-15 nanti.

Walaupun masyarakat nelayan di Malaysia dikatakan hanya 0.63% daripada keseluruhan jumlah pemilih berdaftar iaitu 14.49 juta orang, tetapi kumpulan ini mempunyai kesan ke atas kerajaan yang memerintah. Jadi, sokongan kumpulan nelayan kepada kerajaan semasa adalah penting bagi menentukan “jatuh” atau “kekal” sebuah kerajaan yang memerintah seperti dalam PRU-15 nanti. Dalam PRU-14, kerajaan Barisan Nasional (BN)

telah tumbang dan kerajaan telah bertukar tangan kepada Pakatan Harapan (PH). Namun, PH hanya mampu bertahan selama 22 bulan sebelum kerajaan diterajui pula oleh Perikatan Nasional (PN)

Disebabkan sistem pilihan raya di Malaysia berasaskan majoriti mudah, maka kelebihan undi yang kecil pun boleh memberi kemenangan kepada mana-mana calon. Keadaan yang sama juga boleh berlaku apabila parti politik memiliki kelebihan kerusi di DUN atau Parlimen, maka ia berhak menubuhkan kerajaan. Justeru, dalam keadaan ini, undi nelayan juga amat penting. Atas sebab itu, dalam PRU atau pilihan raya kecil (PRK), parti-parti politik dan calon-calon yang bertanding tidak mengabaikan undi kumpulan ini. Keadaan ini dapat disaksikan dalam PRK di Parlimen Tanjung Piai, apabila ada kesungguhan bagi PH untuk memenangi kerusi itu dengan cara menghulurkan bantuan kepada nelayan. Tindakan kerajaan PH itu telah dikritik oleh BERSIH 2.0 kerana didakwa menggunakan dana kerajaan untuk memancing undi nelayan.

Senario di atas sedikit sebanyak memberi gambaran bahawa undi nelayan itu amat penting. Justeru, kerajaan sentiasa berusaha menarik sokongan nelayan agar kekal memberi undi kepada calon daripada parti kerajaan. Atas sebab itu, banyak bantuan dan program yang telah dijalankan untuk menyelesaikan masalah dan beban hidup yang dihadapi oleh nelayan sama ada ia secara langsung melalui Jabatan Perikanan Malaysia dan LKIM atau agensi-agensi yang lain. Walau bagaimanapun, semua itu bukanlah jaminan untuk nelayan boleh dan terus memberi undi kepada calon parti kerajaan khususnya dalam PRU-15 nanti.

Berdasarkan setiap isu dan perkara yang dibahaskan di atas, kajian ini dijalankan bertujuan menganalisis impak dasar dan program bantuan kerajaan terhadap masyarakat nelayan. Kajian ini juga berusaha menilai kecenderungan sokongan nelayan kepada kerajaan walaupun mereka menerima banyak bantuan melalui pelbagai dasar dan program yang telah dilaksanakan oleh kerajaan. Secara khususnya objektif kajian ini ialah untuk mengkaji faktor dominan yang mempengaruhi sokongan masyarakat nelayan kepada kerajaan;

METODOLOGI

Kajian ini melibatkan semua PNK di seluruh negara yang berjumlah 89 buah. Kerja lapangan dijalankan dalam tempoh dua bulan bermula 01 Disember 2021 hingga 31 Januari 2022. Kaedah kuantitatif diaplikasikan dalam kajian ini Borang soal selidik merupakan instrumen utama dalam kajian ini. Borang soal selidik ini mengandungi 7 bahagian utama termasuklah maklumat peribadi dan soalan berkaitan pembolehubah kajian. Dalam kajian ini, pensampelan bukan kebarangkalian iaitu pensampelan bertujuan (*purposive sampling*) digunakan dalam menentukan sampel kajian. Bagi kajian menggunakan kaedah tinjauan dengan mengedarkan soal selidik, penyelidik tidak mengawal dan tidak bersemuka dengan sampel, di mana memadai menggunakan saiz sampel minimum sebagaimana disarankan oleh Krejcie dan Morgan (1970). Unit analisis dalam kajian ini adalah kumpulan nelayan di Malaysia yang berdaftar dengan PNK masing-masing yang menerima elaun sara hidup daripada kerajaan. Kerangka analisis bagi kajian ini dalam menentukan pembolehubah bebas dan bersandar seperti ditunjukkan dalam Rajah 1 di bawah.



Rajah 1. Kerangka Analisis

Bagi menjawab objektif kajian, analisis inferensi menggunakan regresi berganda bertujuan mengenal pasti hubungan setiap pembolehubah bebas sama ada signifikan dalam mempengaruhi pembolehubah bersandar atau sebaliknya. Analisis regresi berganda juga bertujuan mengenal pasti faktor dominan yang mempengaruhi sokongan rakyat dalam PRU-15.

ANALISIS DAN CADANGAN

Analisis deskriptif bagi menentukan nilai min bagi setiap pembolehubah yang dikaji dalam menilai kecenderungan sokongan nelayan dalam PRU-15 seperti ditunjukkan dalam Jadual 1. Berdasarkan kepada nilai min bagi setiap pembolehubah yang diperolehi, maka kecenderungan sokongan nelayan dapat dirumuskan dalam kategori putih iaitu menyokong. Hal ini diputuskan berdasarkan kepada pengiraan min senggat, di mana nilai min lebih tinggi daripada 2.33 dikategorikan sebagai putih iaitu menyokong.

Jadual 1. Analisis Deskriptif Pembolehubah Kajian

Descriptive Statistics		
	Mean	Std. Deviation
Kualiti Hidup	2.7657	.30235
Pengaruh Media Massa	2.7332	.30905
Dasar dan Program Bantuan Kerajaan	2.7047	.37900
Langkah Kerajaan Memajukan Ekonomi Rakyat	2.6836	.28933
Prestasi Wakil Rakyat (Pemimpin)	2.5264	.56708

Analisis deskriptif di atas menunjukkan bahawa masyarakat nelayan berdasarkan kadar responden yang terlibat dalam kajian ini boleh dirumuskan sebagai cenderung menyokong kerajaan terutama sekali dipengaruhi oleh faktor paling tinggi iaitu indeks kualiti hidup dengan nilai min 2.7657. Walau bagaimanapun, pembolehubah prestasi wakil rakyat (pemimpin) mencatatkan nilai min terendah iaitu 2.5264, di mana diramal mampu mempengaruhi sokongan nelayan kepada wakil rakyat sedia ada dalam PRU-15. Justeru, wakil rakyat perlu meningkatkan kualiti perkhidmatan, sentiasa peka kepada keperluan dan tuntutan rakyat, di samping boleh menjadi penghubung rakyat dengan kerajaan khususnya dalam mewakili masyarakat nelayan di kawasan masing-masing.

Keputusan analisis regresi berganda seperti ditunjukkan dalam Jadual 2 di bawah. Model regresi menyatakan lima (5) pembolehubah bebas kajian iaitu: (i) penilaian terhadap dasar dan program bantuan kerajaan; (ii) langkah kerajaan memajukan ekonomi rakyat; (iii) pengaruh media massa; (iv) kualiti hidup; dan (v) prestasi wakil rakyat (pemimpin) mempengaruhi jangkakan PRU-15 (pembolehubah bersandar) secara signifikan menerangkan 53.1% varians dalam jangkakan PRU-15 ($R^2 = .531$, nilai $F(5,4873) = 1103.190$, $p = .000$). Berdasarkan kepada nilai p yang kurang dari 0.05, maka nilai ini menunjukkan bahawa kelima-lima pembolehubah bebas dalam kajian ini mempengaruhi pembolehubah bersandar kajian secara signifikan.

Jadual 2. Koefisien untuk Analisis Regresi Jangkakan PRU-15

Model	Unstandardized Coefficients		Standardized Coefficients	t	Sig.	Posisi
	B	Std. Error	Beta			
(Konstan)	.066	.037		1.783	.075	
Kualiti Hidup	.328	.018	.277	18.424	.001	1
Langkah Kerajaan Memajukan Ekonomi Rakyat	.309	.019	.250	16.572	.001	2
Pengaruh Media Massa	.224	.016	.193	14.361	.001	3
Prestasi Wakil Rakyat (Pemimpin)	.099	.007	.157	14.221	.001	4
Dasar dan Program Bantuan Kerajaan	.027	.011	.028	2.341	.019	5
	R ² = Adj R ² =			Nilai F (5,4873) = 1103.190		Sig = .000
	.531					

Seterusnya, objektif kajian ini adalah untuk melihat secara terperinci pembolehubah bebas yang paling mempengaruhi pembolehubah bersandar. Berdasarkan objektif ini, laporan analisis dapatan kajian dibuat berdasarkan jadual koefisien seperti ditunjukkan dalam Jadual 2 di atas. Berdasarkan keputusan analisis yang diperolehi, pembolehubah bebas yang paling tinggi mempengaruhi jangkakan sokongan nelayan dalam PRU-15 adalah kualiti hidup ($\beta = .277$; $t = 18.424$, $p = .001$); diikuti oleh pembolehubah langkah kerajaan memajukan ekonomi rakyat ($\beta = .250$; $t = 16.572$, $p = .001$); pembolehubah pengaruh media massa ($\beta = .193$; $t = 14.361$, $p = .001$); prestasi wakil rakyat (pemimpin) ($\beta = .157$; $t = 14.221$, $p = .001$); dan terakhir penilaian terhadap dasar dan program bantuan kerajaan ($\beta = .028$; $t = 2.341$, $p = .019$). Jadi, faktor dominan mengikut posisi yang paling mempengaruhi pembolehubah bersandar iaitu jangkakan PRU-15 seperti ditunjukkan dalam Jadual 2 di atas adalah kualiti hidup.

Daripada analisis dapatan kajian, secara ringkasnya dapatan kajian ini mencapai objektif kajian, di mana terbukti dasar dan program bantuan memberi impak terhadap kecenderungan sokongan nelayan kepada kerajaan. Secara ringkasnya dapatan kajian menunjukkan masyarakat nelayan di Malaysia adalah menyokong kerajaan. Ini merujuk kepada jadual interpretasi kecenderungan sokongan nelayan berdasarkan nilai min, di mana penilaian menunjukkan masyarakat nelayan cenderung menyokong kerajaan (kategori warna putih) dalam PRU-15. Kecenderungan sokongan itu dipengaruhi oleh beberapa faktor, di mana faktor paling dominan ialah kualiti hidup. Ini diikuti oleh pengaruh media massa; dasar dan program bantuan kerajaan dan langkah kerajaan memajukan ekonomi rakyat. Sementara itu,

faktor paling rendah dalam mempengaruhi sokongan rakyat adalah prestasi pemimpin (wakil rakyat) di kawasan masing-masing. Justeru, daripada dapatan kajian ini, wakil rakyat (ahli Parlimen atau DUN) mesti menggandakan usaha mereka dalam menyampaikan perkhidmatan dan membantu rakyat dalam kawasan pilihan raya masing-masing. Hal ini adalah sangat signifikan dalam tempoh baki penggal PRU-14, di mana wakil rakyat perlu memanfaatkan ruang dan peluang yang ada untuk mengekalkan dan menarik sokongan pengundi dalam kalangan nelayan jika berhasrat ingin bertanding semula dalam PRU-15.

RUJUKAN

- Hayrol Azril Mohamed Shaffril, *et. al.* (2011). Has the Sea Changed? Qualitative Analyses on the Views of Fishermen in the East Coast Zone of Peninsular. *American Journal of Environmental Sciences*, 7(5), 448-455.
- Junhairi Alyasa. 2020. Covid-19: Perintah Kawalan Pergerakan di Seluruh Negara Bermula 18 Mac. *Sinar Harian* (16 Mac).
- Lembaga Kemajuan Ikan Malaysia (LKIM). 2021. *Citra Kejayaan LKIM: Lima Dekad Satu Azam*. Puchong: Lembaga Kemajuan Ikan Malaysia.
- Lembaga Kemajuan Ikan Malaysia (LKIM). *Laporan Tahunan 2014, 2015, 2016, 2017, 2018, 2019 dan 2020*. Diakses dari <https://www.lkim.gov.my/laporan-tahunan>. (28 Ogos 2022).
- Mohamad Hussin. (2018). Kebajikan Nelayan Terbela. *Harian Metro* (30 Mac)
- Muhammad Wafi Ramli, and Sharifah Rohayah Sheikh Dawood, and Sofia Haminah Mohd Som, (2019) [Cabaran hidup miskin dalam kalangan komuniti nelayan di Tanjung Dawai, Kedah](#). *Geografia : Malaysian Journal of Society and Space*, 15 (1). pp. 54-66. ISSN 2180-2491.
- Rusnan Mustafa. (2017). Pelbagai Dasar, Program Dirangka Bela Nelayan. *Utusan Borneo*. (01 Mei).
- Zanariah Abd Mutalib & Nor Azizah Mokhtar. 2020. COVID-19: Nelayan Dibenar Ke Laut. *Berita Harian* (21 Mac).

Dasar dan Program Bantuan Kerajaan Kepada Masyarakat Nelayan: Keperluan atau Keprihatinan?

Malike Brahim

Universiti Utara Malaysia
malike@uum.edu.my

Yusuf Pon

Universiti Utara Malaysia
p.yusuf@uum.edu.my

Musliza Mohamad

Politeknik Sultan Abdul Halim Mu'adzam Shah
musliza3097@gmail.com

ABSTRAK

Apabila Perintah Kawalan Pergerakan dikuatkuasakan mulai 18 Mac 2020, semua lapisan masyarakat di Malaysia menghadapi banyak kesukaran. Keadaan yang sama berlaku dalam kalangan masyarakat nelayan yang majoritinya dalam kategori B40. Bagi menangani masalah yang dihadapi masyarakat nelayan, kerajaan melalui Lembaga Kemajuan Ikan Malaysia telah menyediakan pelbagai program bantuan dari semasa ke semasa. Justeru, artikel ini bertujuan mengimbas dasar-dasar dan program bantuan yang telah dilaksanakan oleh kerajaan kepada masyarakat nelayan. Kajian yang dijalankan melibatkan kumpulan nelayan yang menerima elaun sara hidup. Dapatan kajian menunjukkan dasar dan program bantuan mempengaruhi kecenderungan sokongan masyarakat nelayan kepada kerajaan dalam pilihan raya umum (PRU) ke-15. Faktor paling dominan yang mempengaruhi sokongan nelayan adalah pembolehubah kualiti hidup, diikuti pembolehubah langkah kerajaan memajukan ekonomi rakyat; pengaruh media massa; dan dasar dan program bantuan kerajaan. Sebaliknya, pembolehubah prestasi wakil rakyat (pemimpin) adalah faktor paling rendah mempengaruhi sokongan nelayan. Justeru, wakil rakyat perlu meningkatkan kualiti perkhidmatan, sentiasa peka kepada keperluan rakyat dan perlu kerap turun ke kawasan masing-masing untuk meninjau dan mengenal pasti masalah yang dihadapi oleh masyarakat nelayan jika ingin bertanding semula dalam PRU-15. Dalam pada itu, dicadangkan agar kualiti penyampaian perkhidmatan dapat ditingkatkan dan kadar bantuan kepada nelayan perlu dikaji semula dan ditambah baik mengikut keadaan semasa.

Kata kunci: bantuan; dasar; nelayan; pilihan raya; sokongan.

ABSTRACT

When the government enforced the Movement Control Order on March 18, 2020, all levels of society in Malaysia faced many difficulties. The same situation occurs in the fishing community, where the majority are in the B40 category. To solve the problems faced by the fishing community, the government, through the Malaysian Fisheries Development Authority (LKIM), has provided various assistance programmes from time to time. Therefore, this article aims to review the policies and aid programmes the government has implemented for the fishing community. The study involved a group of fishermen who received a subsistence allowance. The findings of the study show policies and assistance programmes influence the tendency of the fishing community to support the government in the 15th General Election. The most dominant factors affecting fishermen's support are the quality of life, followed by the government's measures to advance the people's economy; mass media influence; and government assistance policies and programmes. Otherwise, the performance variable of

elected representatives (leaders) is the lowest factor affecting fishermen's support. Therefore, elected representatives need to improve the quality of service, always be sensitive to people's needs, and should regularly visit their constituency to survey and identify the problems faced by the fishing community if they wish to retain their seat in the 15th General Election. It is suggested that the quality-of-service delivery can be improved, and the rate of assistance to fishermen needs to be reviewed and improved according to the current situation.

Keywords: *assistance; elections; fishermen; policy; support.*

PENGENALAN

Kerajaan Malaysia telah melaksanakan banyak dasar berbentuk jangka pendek dan jangka panjang melalui pelbagai program kepada semua rakyat termasuklah nelayan. Semua dasar yang dilaksanakan itu bertujuan menyelesaikan pelbagai masalah yang berlaku dalam masyarakat. Namun, tidak semuanya dapat diselesaikan dalam masa yang singkat, tetapi ada sesetengahnya memakan masa yang panjang untuk diselesaikan. Hakikatnya, sama ada cepat atau lambat, pelaksanaan pelbagai dasar dan program oleh kerajaan setidak-tidaknya dapat meringankan beban dan menyelesaikan masalah yang ditanggung rakyat.

Keadaan begitu rumit sewaktu negara dilanda pandemik Covid-19 hingga Perintah Kawalan Pergerakan (PKP) dikuatkuasakan. Hampir keseluruhan masyarakat berada dalam kesulitan kerana tiada sebarang pergerakan dibenarkan. Macam-macam masalah yang timbul seperti kehabisan bekalan makanan, tiada pekerjaan, hilang mata pencarian, dan lain-lain keperluan. Setelah kelonggaran pergerakan diberikan, sedikit sebanyak masalah keperluan asas dapat ditangani. Keadaan kehidupan masyarakat walaupun banyak terjejas, tetapi kelihatan lebih stabil dalam tempoh PKP dilanjutkan. Bagi menangani pelbagai masalah rakyat, pelbagai dasar dan program bantuan telah dilaksanakan oleh kerajaan.

Bagi masyarakat nelayan, sepanjang tempoh PKP, ia telah memberi kesan yang mendalam kepada mereka. Namun, kerajaan tidak membiarkan kumpulan masyarakat nelayan bersendirian. Sebelum, semasa dan selepas PKP, kerajaan terus konsisten membantu masyarakat nelayan. Cuma, di peringkat awal PKP, kehidupan masyarakat nelayan sangat terjejas kerana tidak boleh ke laut untuk menangkap ikan. Persoalannya, adakah dasar dan program bantuan kerajaan itu suatu keperluan atau keprihatian kerajaan kepada masyarakat nelayan? Jadi, perkara inilah yang cuba dibahaskan dalam esei ini.

PERANAN MAFI DAN LKIM

Kementerian Pertanian dan Industri Makanan (MAFI) dan Lembaga Kemajuan Ikan Malaysia (LKIM) sebenarnya telah berperanan secara langsung membantu masyarakat nelayan melalui pelbagai dasar dan program yang telah dirancang walaupun berhadapan dengan PKP. Bahkan kerjasama yang baik antara MAFI dengan kerajaan-kerajaan negeri memudahkan urusan pelaksanaan dasar dan menyalurkan program bantuan kepada masyarakat nelayan. Misalnya, pelancaran Gelombang Nelayan Nasional (GNN) 2018 merupakan program berbentuk aktiviti turun padang dan ramah mesra membabitkan kerjasama antara sektor kerajaan, swasta serta nelayan (Mohamad Hussin, 2018).

GNN adalah medium penyaluran maklumat tentang dasar kerajaan dan penyampaian perkhidmatan oleh agensi kerajaan kepada masyarakat nelayan. Dalam usaha itu, LKIM diberi tanggungjawab untuk memperbaiki kedudukan sosio-ekonomi nelayan dengan tumpuan kepada peningkatan pendapatan; memajukan perusahaan perikanan negara; dan menjaga

kebijakan sosial dan ekonomi masyarakat nelayan. Melalui GNN, hubungan erat antara pemimpin, jabatan dan agensi kerajaan dengan masyarakat nelayan dapat dibentuk. Ini bertepatan dengan peranan GNN dalam menyalurkan maklumat tentang dasar dan perkhidmatan kerajaan kepada masyarakat nelayan.

Sementara itu, pelbagai dasar dan program telah dirangka untuk keperluan masyarakat nelayan di Malaysia. Peranan itu dilaksanakan oleh LKIM dan Jabatan Perikanan Malaysia (DOF) bagi menangani pelbagai masalah dalam hidup nelayan di negara ini (Rusnan, 2017). Semua usaha itu membuktikan komitmen kerajaan demi kesejahteraan masyarakat nelayan agar ia sentiasa terjamin dan diberikan keutamaan. Antaranya, kerajaan telah membayar elaun sara hidup nelayan (ESHN) berjumlah RM200.00 bermula pada tahun 2015 dan ditambah menjadi RM300.00 pada tahun 2016. Selain ESHN, kerajaan melaksanakan Projek Khas Perumahan Nelayan (PKPN) merangkumi proses membaik pulih dan membina rumah. Contohnya, 39 buah rumah di bawah Persatuan Nelayan Kawasan (PNK) Asajaya/Semera telah diluluskan untuk dibaik pulih (Rusnan, 2017).

Selain itu, kerajaan telah menyalurkan banyak bantuan kepada masyarakat nelayan menerusi Projek AZAM Tani; Program Basmi Kemiskinan Nelayan; Program Peningkatan Pendapatan Nelayan; Program Transformasi Nelayan; Program Pasar Nelayan; dan pembinaan Kompleks Pendaratan Ikan seperti dalam perbincangan berikutnya. Selain itu, kerajaan juga mahu masyarakat nelayan keluar dari kepompong kemiskinan dan tidak bergantung kepada bantuan dan subsidi kerajaan semata-mata khususnya di luar musim menangkap ikan. Justeru, nelayan digalakkan untuk meneroka bidang perusahan makanan halal berasaskan ikan seperti menghasilkan keropok ikan, burger ikan atau makanan sejuk beku. Atas sebab itu, DOF dan Institut Penyelidikan dan Kemajuan Pertanian Malaysia (MARDI) ada menyediakan kursus dan latihan bagi supaya nelayan boleh menjadi usahawan.

DASAR DAN PROGAM BANTUAN KERAJAAN MELALUI LKIM

Kesan Pandemik Covid-19 dan PKP begitu ketara terhadap masyarakat nelayan. PKP adalah larangan menyeluruh pergerakan dan perhimpunan ramai di seluruh negara merangkumi aktiviti keagamaan, sukan, sosial dan budaya (Junhairi Alyasa, 2020). Disebabkan oleh PKP, nelayan mengalami masalah kewangan dan hilang mata pencarian hinggalah kelonggaran diberikan oleh kerajaan pada 20 Mac 2020 melegakan mereka apabila dibenarkan ke laut untuk menangkap ikan. Keputusan itu dibuat bagi memastikan bekalan makanan mencukupi (Zanariah & Nor Azizah, 2021).

Beberapa aktiviti utama telah disusun oleh LKIM demi kepentingan masyarakat nelayan seperti (i) bantuan kepada masyarakat nelayan; (ii) pembangunan sosio-ekonomi masyarakat nelayan; (iii) pemasaran dan pelesenan; (iv) pembangunan infrastruktur; (v) pembangunan industri asas tani; (vi) kawalselia pendaratan ikan dan penguatkuasaan; (vii) pengurusan organisasi; dan (viii) khidmat pengurusan. Selain itu, LKIM juga telah merancang dan menyusun banyak program bertujuan meningkatkan taraf hidup masyarakat nelayan melalui pelbagai aktiviti yang disusun.

Setiap tanggungjawab di atas dilaksanakan selari dengan misi dan visi LKIM bagi memastikan peruntukan yang diterima dapat disalurkan kepada golongan sasaran. Bagi tahun 2020, LKIM telah menerima peruntukan sebanyak RM120,123,700.00 melalui Peruntukan Wang Mengurus, RM124,500,100.00 Peruntukan Pembangunan dan RM165,750,967.00 melalui Peruntukan Khas. Walaupun berdepan dengan pelbagai cabaran dan kekangan pada

tahun 2020 disebabkan Pandemik COVID-19 dan PKP, warga LKIM telah menunjukkan komitmen tinggi dalam menjalankan pelbagai aktiviti dan program pembangunan yang memberi banyak manfaat kepada masyarakat nelayan dan pemegang taruh yang terlibat (Laporan Tahunan LKIM, 2020).

Antara program bantuan yang telah dilaksanakan oleh LKIM kepada masyarakat nelayan seperti:

- i) Skim Bantuan Bencana Alam dan Kebajikan Nelayan;
- ii) Elaun Sara Hidup Nelayan (ESHN);
- iii) Bantuan Azam Tani/Rezeki Tani;
- iv) Program Khas Perumahan Nelayan (PKPN):
 - a. Baik Pulih Rumah;
 - b. Bantuan Bina Baru; dan
 - c. Penempatan Semula Nelayan.
- v) Program Insentif Hasil Tangkapan Ikan (IHTI);
- vi) Bantuan *Touch Point*;
- vii) Infrastruktur Nelayan; dan
- viii) Usahawan Bimbingan LKIM.

Selain itu, program bantuan lain yang dilaksanakan oleh LKIM seperti: (i) Program Pinjaman Dana Nelayan; (ii) Skim Perlindungan Insurans Berkelompok; (iii) Pengurusan Skim Subsidi Diesel dan Petrol Nelayan; dan (iv) Kumpulan Keselamatan Nelayan (KESAN). Namun, esei ini hanya membincangkan dasar dan program terpilih bagi menjelaskan kedudukan masyarakat nelayan di Malaysia. Semua data yang dipamerkan dalam setiap jadual adalah berdasarkan kepada Laporan Tahunan 2020 yang dikeluarkan oleh LKIM.

a) *Program Pinjaman Dana Nelayan*

Program ini menyediakan pinjaman mudah kepada nelayan untuk pembelian bot dan peralatan baru serta bertujuan meningkatkan keupayaan bot sedia ada; pinjaman modal operasi; pinjaman kecemasan; dan peruntukan pengurusan projek atau pembinaan komponen sektor ekonomi persatuan nelayan. Program ini melibatkan Skim Pinjaman Pembangunan Institusi Nelayan (SPIN); Skim Pinjaman Nelayan Enjin Dalam (SNED); Skim Pinjaman Nelayan Pantai (SNEP) dan lain-lain seperti ditunjukkan dalam Jadual 1 di bawah.

Jadual 1. Skim Pinjaman Dana Nelayan Tahun 2020

Skim	Jumlah Pinjaman (RM)	Penerima Faedah	
		PNK	Nelayan
SNEP	751,630.00	0	44
SPIN	4,650,000.00	6	0
SNED	335,850.00	0	10
Jumlah Keseluruhan	5,737,480.00	6	54

b) *Skim Bantuan Bencana Alam dan Kebajikan Nelayan*

Skim ini bertujuan memberi bantuan segera dalam bentuk wang kepada nelayan yang ditimpa kemalangan, kemusnahan atau kerosakan harta benda dan kehilangan nyawa bagi meringankan beban mangsa dan keluarga. Bagi tahun 2020, seramai 1,049 orang telah menerima pampasan bernilai RM1,349,628.00 seperti ditunjukkan dalam Jadual 2 di bawah.

Jadual 2. Skim Bantuan Bencana Alam (2016-2020)

Tahun	Bilangan Bantuan Penerima	Nilai (RM)
2020	1,049	1,349,628.00
2019	930	1,472,790.00
2018	1,434	2,127,361.00
2017	831	2,011,863.20
2016	630	1,893,025.08

c) Elaun Sara Hidup Nelayan (ESHN)

ESHN adalah bantuan secara bulanan kepada pemilik individu vesel perikanan dan pekerja warganegara yang bekerja di atas vesel berlesen. Ia bertujuan meringankan bebanan nelayan bagi menghadapi tekanan ekonomi disebabkan peningkatan kos sara hidup seperti ditunjukkan dalam Jadual 3 di bawah. Perbezaan jumlah yang ketara bagi tahun 2019 disebabkan oleh program pemutihan yang dijalankan bermula Julai 2018 dan pemansuhan kategori penerima bagi pemilik zon B, C dan C2 menyebabkan penurunan jumlah penerima ESHN.

Jadual 3. Penyaluran ESHN (2016-2020)

Tahun	Bilangan Penerima	Nilai (RM)
2020	39,089	100,703,500.00
2019	45,380	87,297,600.00
2018	53,729	162,530,050.00
2017	56,149	166,071,650.00
2016	58,621	174,242,700.00

d) Skim Subsidi Diesel dan Petrol Nelayan

Skim ini yang mula dilaksanakan pada tahun 2006 adalah untuk membantu menampung sebahagian kos operasi menangkap ikan yang ditanggung oleh nelayan kesan kenaikan harga minyak. Pada 2020, sebanyak 48,960 pemilik vesel menerima subsidi minyak seperti ditunjukkan dalam Jadual 4. Jumlah penyaluran diesel dan petrol bersubsidi pada 2020 bagi zon tangkapan A, B dan C ialah 335,377,514 liter bernilai RM421,786,185.00. Jumlah keseluruhan subsidi petrol bagi tahun 2016-2020 seperti ditunjukkan dalam Jadual 5 di bawah.

Jadual 4. Kelulusan Penerima Minyak Bersubsidi Petrol dan Diesel

Tahun	2020	2019	2018	2017	2016
Diesel	13,944	17,068	17,055	17,601	17,413
Petrol	35,016	35,944	37,663	37,451	36,694
Jumlah	48,960	53,012	54,718	55,052	54,107

Jadual 5. Jumlah Subsidi Petrol Kepada Nelayan (2016-2020)

Tahun	Kuantiti (Liter)	Jumlah Subsidi (RM)
2020	35,024,444	6,488,777.34
2019	73,776,873	46,409,975.32
2018	88,400,653	66,464,372.62
2017	84,807,159	47,045,552.23
2016	46,625,063	9,484,948.70

e) Projek Khas Perumahan Nelayan (PKPN)

Tiga komponen utama PKPN iaitu: (i) baik pulih rumah nelayan; (ii) bina baru rumah nelayan; dan (iii) penempatan semula rumah nelayan. Kos maksimum untuk program ini ialah RM13,000.00 bagi Semenanjung Malaysia dan RM15,000.00 bagi Sabah, Sarawak dan Labuan. LKIM telah membaik pulih 3,422 rumah nelayan di seluruh Semenanjung, Sabah, Sarawak dan Labuan dari tahun 2016 hingga 2020 dengan kos sejumlah RM43,590,000.00 seperti ditunjukkan dalam Jadual 6 di bawah.

Jadual 6. Bilangan Penerima Program Baik Pulih Rumah (2016-2020)

NEGERI	TAHUN 2020		TAHUN 2019		TAHUN 2018		TAHUN 2017		TAHUN 2016		JUMLAH	
	BIL.	RM	BIL.	RM	BIL.	RM	BIL.	RM	BIL.	RM	BIL.	RM
Perlis	2	26,000.00	7	91,000.00	11	143,000.00	-	-	18	180,000.00	38	440,000.00
Kedah	1	13,000.00	184	2,392,000.00	-	-	-	-	126	1,260,000.00	311	3,665,000.00
Pulau Pinang	-	-	6	78,000.00	9	117,000.00	-	-	11	110,000.00	26	305,000.00
Perak	-	-	90	1,170,000.00	-	-	4	52,000.00	-	-	94	1,222,000.00
Selangor	11	143,000.00	103	1,339,000.00	-	-	37	481,000.00	88	880,000.00	239	2,843,000.00
Negeri Sembilan	-	-	3	39,000.00	-	-	-	-	-	-	3	39,000.00
Melaka	57	741,000.00	-	-	-	-	-	-	-	-	57	741,000.00
Johor	1	13,000.00	48	624,000.00	-	-	-	-	178	1,780,000.00	227	2,417,000.00
Pahang	5	65,000.00	10	130,000.00	-	-	2	26,000.00	56	560,000.00	73	781,000.00
Terengganu	38	494,000.00	77	1,001,000.00	-	-	10	130,000.00	-	-	125	1,625,000.00
Kelantan	6	78,000.00	-	-	8	104,000.00	46	598,000.00	31	310,000.00	91	1,090,000.00
Sarawak	13	195,000.00	378	5,670,000.00	31	465,000.00	309	4,635,000.00	359	4,308,000.00	1,090	15,273,000.00
Sabah	-	-	111	1,665,000.00	-	-	41	615,000.00	857	10,284,000.00	1,009	12,564,000.00
Wilayah Persekutuan Labuan	8	120,000.00	11	165,000.00	20	300,000.00	-	-	-	-	39	585,000.00
JUMLAH	142	1,888,000.00	1,028	14,364,000.00	79	1,129,000.00	449	6,537,000.00	1,724	19,672,000.00	3,422	43,590,000.00

Kerajaan persekutuan telah menyediakan peruntukan bagi membina rumah nelayan dengan kos maksimum RM56,000.00 bagi Semenanjung Malaysia dan RM68,000.00 bagi Sabah, Sarawak dan Labuan. Tambahan maksimum 10 peratus (%) daripada kos sebenar boleh dipertimbang di kawasan pulau dan pedalaman yang tiada kemudahan pengangkutan sempurna. LKIM telah membina rumah baharu sebanyak 234 buah rumah nelayan di seluruh Semenanjung, Sabah, Sarawak dan Wilayah Persekutuan Labuan (2016-2020) dengan kos berjumlah RM13,896,000.00 (Laporan Tahunan LKIM, 2020).

f) Penempatan Semula Nelayan (PSN)

PSN merupakan usaha kerajaan persekutuan melalui MAFI dan LKIM yang bekerjasama dengan kerajaan negeri. Kerajaan persekutuan telah menyediakan peruntukan membina rumah dengan kos maksimum RM70,000.00 sebuah di Semenanjung Malaysia dan RM90,000.00 di Sabah, Sarawak dan Labuan. Peruntukan RM1 juta juga disalurkan bagi membangunkan prasarana asas seperti dewan serbaguna, surau, gelanggang futsal, taman permainan, tadika, kedai dan lain-lain yang bersesuaian di setiap lokasi PSN. Bagi mewujudkan PSN di beberapa lokasi, LKIM telah memperuntuk sebanyak RM191,980,000.00 (tahun 2013-2020) di seluruh negara untuk 1,822 nelayan (Laporan Tahunan LKIM, 2020).

g) Pasar Nelayan

Dalam tahun 2020, sebanyak RM4.5 juta peruntukan bagi pembinaan pasar nelayan baharu, peningkatan pasar nelayan sedia ada dan galakan pasaran. Sebanyak empat (4) pasar nelayan

baharu dibina seperti dalam Jadual 8 melibatkan kos sebanyak RM479,500.00 dan 64 buah pasar nelayan sedia ada telah dibuat peningkatan melibatkan kos RM3,517,759.00.

Jadual 8. Pembinaan Pasar Nelayan Baharu

Bil.	Negeri	Pasar Nelayan
1.	Negeri Sembilan	PNN Negeri Sembilan
2.	Terengganu	Kompleks LKIM Chendering
3.	Kelantan	Pasar Seringgit, Bachok
4.	Selangor	Taman Wahyu, Kuala Lumpur

h) *Pembangunan Akuakultur*

Program ini bertujuan menggalak, mengembang dan memajukan industri akuakultur sebagai penyumbang kepada pengeluaran bekalan ikan negara melalui tiga (3) aktiviti utama iaitu: (i) Pembangunan Infrastruktur Akuakultur; (ii) Insentif Ternakan kepada Persatuan Nelayan dan Penternak; dan (iii) Khidmat dan Bimbingan Akuakultur. Sebanyak RM5,500,000.00 telah diperuntuk di bawah Kumpulan Wang Pembangunan (KWP) pada tahun 2020 bagi menyokong program ini. Pada tahun 2020, sebanyak empat (4) kerja pembangunan infrastruktur telah dilaksanakan iaitu Projek Taman Akuakultur Badong, Pahang, Projek Pembangunan Ternakan Akuakultur Fasa 2 Sebatu, Melaka, Projek Pembangunan Ternakan Akuakultur Fasa 4 Sebatu, Melaka dan Projek Pembangunan Ternakan Akuakultur di Kampung Telaga Air, Sarawak seperti dalam Jadual 9 di bawah.

Jadual 9. Program Pembangunan Infrastruktur Akuakultur Tahun 2020

Bil.	Projek	Peruntukan (RM)
1.	Projek Taman Akuakultur Badong, Pahang	2,000,000.00
2.	Projek Pembangunan Ternakan Akuakultur Fasa 2 Sebatu, Melaka	320,000.00
3.	Projek Pembangunan Ternakan Akuakultur Fasa 4 Sebatu, Melaka	1,000,000.00
4.	Projek Pembangunan Ternakan Akuakultur Di Kampung Telaga Air, Sarawak	750,000.00
Jumlah Keseluruhan		4,070,000.00

Sebanyak RM1,116,850.00 insentif telah disalurkan pada tahun 2020 bagi program Insentif Ternakan kepada PN dan Penternak Akuakultur berbentuk bantuan penyediaan kemudahan peralatan ternakan dan dana berbentuk *in-kind* melibatkan enam (6) PNK dan 26 penternak individu di tujuh (7) buah negeri seluruh negara seperti dalam Jadual 10 di bawah. Projek-projek ternakan seperti ternakan ikan dalam sangkar, dalam kolam, dalam tangki; ternakan udang dalam kolam; ternakan moluska serta pengeluaran hatcheri dan nurseri. Manakala sebanyak RM120,000.00 diperuntuk bagi program Khidmat Bimbingan Akuakultur yang menyediakan latihan dan bimbingan secara *hands-on* kepada penternak.

Jadual 10. Peruntukan Program Insentif Tahun 2020

Bil.	Negeri	PN	Peruntukan (RM)	Penternak (Orang)	Peruntukan (RM)
1.	Pahang	1	40,000.00	3	56,500.00

2.	Kelantan	2	183,000.00	0	0.00
3.	Terengganu	1	260,000.00	19	323,350.00
4.	Wilayah Labuan	0	0.00	1	10,000.00
5.	Negeri Sembilan	2	197,100.00	1	7,900.00
6.	Selangor	0	0.00	1	20,000.00
7.	Kedah	0	0.00	1	19,000.00

i) ***Insentif Hasil Tangkapan Ikan (IHTI)***

IHTI diwujudkan bermula Jun 2008 hingga kini untuk menampung sebahagian kos perbelanjaan yang terpaksa ditanggung oleh nelayan ekoran peningkatan harga minyak. Ia juga bertujuan memberi galakan kepada mereka untuk mendaratkan hasil perikanan dan merupakan platform yang digunakan untuk mengawal dan memastikan bahawa minyak subsidi yang dibeli oleh nelayan hanya digunakan untuk aktiviti menangkap ikan melalui sistem e-Pengisytiharan LKIM. Sehingga Disember 2020, bayaran RM11.06 juta telah dikeluarkan bagi pendaratan ikan sebanyak 110,612 tan metrik seperti dalam Jadual 11 di bawah.

Jadual 11. Pembayaran Insentif Hasil Tangkapan Ikan Tahun 2020

Negeri	Kuantiti (KG)	Dibayar (RM)	Jumlah Insentif (RM)
Johor	3,518,201.30		351,820.13
Kedah	8,212,906.30		821,290.63
Kelantan	4,126,896.10		412,689.61
Melaka	534,200.20		53,420.02
Negeri Sembilan	217,181.30		21,718.13
Pahang	17,327,122.00		1,732,712.20
Perak	7,866,307.70		786,630.77
Perlis	6,458,182.50		645,818.25
Pulau Pinang	5,859,035.60		585,903.56
Sabah	30,608,895.70		3,060,889.57
Sarawak	12,075,425.70		1,207,542.57
Selangor	3,592,200.50		359,220.05
Terengganu	7,988,022.60		798,802.26
Wilayah Persekutuan Labuan	2,227,739.70		222,773.97
Jumlah Keseluruhan (RM)	110,612,317.20		11,061,231.72

Sepanjang tahun 2020, sistem e-Pengisytiharan telah merekodkan pendaratan ikan sebanyak 421,915 tan metrik bernilai hampir RM1.26 bilion. Pendaratan tertinggi adalah di negeri Sabah dan diikuti oleh Perak, Pahang dan Sarawak. Rekod pendaratan ini merangkumi semua jenis ikan marin dan air tawar termasuk ikan baja dan kerang-kerangan seperti dalam Jadual 12 di bawah.

Jadual 12. Pengisytiharan Pendaratan Ikan

Tahun	Kuantiti (t)	Nilai (RM)
2020	421,915.93	1,258,997,013
2019	782,563.31	2,369,703,047

2018	914,616.80	2,772,789,762
2017	851,540.10	2,520,810,020
2016	656,390.59	1,671,634,709

j) Pembinaan dan Mengurus Kompleks/Labuhan Perikanan LKIM

Pada tahun 2020, LKIM telah menjalankan beberapa aktiviti pembangunan bertujuan menyediakan kemudahan pendaratan, pengendalian, penyimpanan, pemasaran ikan yang bersepadu serta moden, mewujudkan *one stop centre* bagi menyediakan perkhidmatan kepada nelayan menjalankan aktiviti perikanan seperti:

- (i) **Pembangunan Fasa II Kompleks Perikanan LKIM Kiamsam, Labuan:**
Projek ini telah diluluskan dengan kos sebanyak RM22.5 juta di bawah RMK-11 yang telah dilaksanakan pada Oktober 2018 manakala pelaksanaan fizikal bermula pada 18 Januari 2019 dan dijangka siap pada 7 Disember 2021.
- (ii) **Naik taraf Kompleks Perikanan LKIM Lumut, Perak:**
LKIM telah melaksanakan kerja-kerja menaik taraf melibatkan kerja pembaikan struktur jeti, kemudahan-kemudahan mekanikal dan elektrik melalui peruntukan sebanyak RM2.9 juta yang diluluskan dalam RMK-11 di kompleks ini.
- (iii) **Naik taraf Pelabuhan Perikanan LKIM Kuala Kedah, Kedah:**
Di bawah RMK-11, kerja peningkatan dan menaik taraf pelabuhan ini telah dilaksanakan melibatkan skop kerja struktur jeti pendaratan dan diesel, pendawaian elektrik serta pembaikan mendapan dengan keseluruhan kos RM1.8 juta.
- (iv) **Naik taraf Pelabuhan Perikanan LKIM Tok Bali:**
Melalui RMK-11, sebanyak RM4.5 juta telah diperuntuk bagi menaik taraf kemudahan melibatkan bumbung, pejabat peniaga dan beberapa komponen yang memerlukan penyelenggaraan dan baik pulih struktur bangunan sempena Program Penjenamaan Semula Pelabuhan.
- (v) **Program Pusat Pemprosesan Hasil Perikanan (PPHP)**

Bagi memastikan peningkatan pengeluaran PPHP dan boleh beroperasi dalam keadaan yang kondusif, beberapa program telah dilaksanakan seperti:

- (i) **Penyelenggaraan Pusat Pemprosesan Hasil Perikanan:**
Sepanjang 2020, sebanyak RM948,805.40 telah dibelanjakan bagi menjalankan kerja-kerja penyelenggaraan dan pembaikan kecil di bangunan PPHP seluruh negara berbanding RM378,940.00 pada tahun 2019.
- (ii) **Program Pembangunan Pusat Pemprosesan, Pembungkusan dan Pemasaran (3P):**
MAFI melalui pihak LKIM telah meluluskan peruntukan sebanyak RM249,000.00 di bawah program 3P kepada enam (6) PPHP di bawah kendalian LKIM bagi tahun 2020 seperti dalam Jadual 13 di bawah.

Jadual 13. Peruntukan Diterima PPHP Melalui Program 3P

Bil.	Lokasi	Jumlah Peruntukan (RM)
1.	Pusat Pemprosesan Hasil Perikanan Kuala Perlis, Perlis	26,000.00
2.	Pusat Pemprosesan Hasil Perikanan Perlis Selatan, Perlis	18,000.00
3.	Pusat Pemprosesan Hasil Perikanan Penarak, Langkawi	30,000.00
4.	Pusat Pemprosesan Hasil Perikanan Pangkor, Perak	80,000.00
5.	Pusat Pemprosesan Hasil Perikanan Kemaman, Terengganu	10,000.00
6.	Pusat Pemprosesan Hasil Perikanan Geting Tumpat, Kelantan	85,000.00
Jumlah (RM)		249,000.00

(vi) *Geran-geran Khas*

Usahawan dalam kalangan nelayan yang layak telah menerima pelbagai manfaat yang disediakan oleh LKIM bagi membantu dalam meningkatkan keupayaan keusahawanan mereka melalui bantuan dan bimbingan dengan beberapa geran yang disediakan mengikut tahap nilai jualan tahunan seperti ditunjukkan dalam Jadual 14 di bawah.

Jadual 14. Pembiayaan Berdasarkan Nilai Jualan Tahunan Usahawan

Kategori	Nilai Jualan Tahunan (RM)	Geran Pemadanan
Tahap 1	≤RM50,000	Geran Change Upgrade Product (CUP)
Tahap 2	>RM50,000 hingga ≤RM100,000	
Tahap 3	>RM100,000 hingga ≤RM300,000	
Tahap 4	>RM300,000 hingga ≤RM5,000,000	Geran High Impact Product (HIP)
Tahap 5	>RM5,000,000 hingga ≤RM15,000,000	
Tahap 6	>RM15,000,000 hingga ≤RM50,000,000	Institusi kewangan

(i) **Geran Pemadanan Change Upgrade Product (CUP):**

Bagi tahun 2020, seramai 18 orang usahawan telah mendapat pembiayaan di bawah geran CUP dengan nilai bantuan sebanyak RM411,886.00. CUP merupakan bantuan dalam bentuk geran pemadanan iaitu 70% pembiayaan kerajaan (maksimum RM60,000.00), manakala 30% adalah pembiayaan usahawan melibatkan Usahawan IAT (Tahap 1 hingga 3) yang memperoleh nilai jualan tahunan kurang daripada RM300,000.00 yang meliputi skop seperti (i) Kajian Nutrisi dan Jangka Hayat Produk; (ii) Reka Bentuk Pembungkusan dan Pelabelan; (iii) Peningkatan Kapasiti Pengeluaran; (iv) Penambahbaikan Premis; dan (v) Perolehan Papan Tanda Perniagaan.

(ii) **Geran Pemadanan High Impact Product (HIP):**

HIP disalurkan dalam bentuk geran pemadanan dengan 50% pembiayaan kerajaan (maksimum RM200,000.00) dan 50% adalah pembiayaan usahawan melibatkan Usahawan IAT (Tahap 4 hingga 5) yang memperoleh nilai jualan (RM300,000.00 hingga RM15,000,000.00) yang meliputi skop seperti: (i) Kajian Nutrisi dan

Jangka Hayat Produk; (ii) Reka Bentuk Pembungkusan dan Pelabelan; (iii) Peningkatan Kapasiti Pengeluaran; dan (iv) Penambahbaikan Premis.

(iii) Geran Agropreneur Muda (GAM)

Bagi tahun 2020, seramai 40 orang usahawan telah mendapat pembiayaan GAM dengan nilai sebanyak RM637,635.00 seperti di Jadual 15 di bawah. GAM adalah bantuan 100% pembiayaan kerajaan yang disalurkan dalam bentuk barangan untuk membantu dan menggalakkan golongan belia yang berumur antara 18 hingga 40 tahun menceburi bidang keusahawanan agro berasaskan semua aktiviti di sepanjang rantai nilai sektor pertanian seperti pengeluaran tanaman, ternakan dan perikanan serta industri asas tani termasuk pemasaran, penyediaan perkhidmatan sokongan dan input pertanian dan agro pelancongan.

Jadual 15. Penerima GAM Tahun 2020

Sektor	Bilangan Penerima	Jumlah Pembiayaan (RM)
Industri Asas Tani	17	307,115.00
Perikanan	23	330,520.00
Jumlah	40	637,635.00

PROGRAM BANTUAN KERAJAAN: KEPERLUAN ATAU KEPRIHATINAN?

Berdasarkan kepada Laporan Tahunan LKIM 2020 merangkum maklumat tahun 2016 hingga 2020, kerajaan telah membelanjakan atau mengeluarkan peruntukan yang besar melalui LKIM kepada masyarakat nelayan seperti pembayaran ESHN. Atas sebab itu, ESHN antara bantuan yang sangat membantu kumpulan nelayan. Sebenarnya, program bantuan yang dilaksanakan oleh MAFI dan LKIM bukan hanya sewaktu negara dilanda Pandemik COVID-19 dan PKP dikuatkuasakan, tetapi sebelum itu lagi dan berterusan hingga kini.

Ditimbulkan perbincangan di sini sama ada program bantuan itu suatu keperluan kepada masyarakat nelayan atau bukti kepada keprihatinan kerajaan kepada mereka? Bantuan-bantuan seperti ESHN, PSN dan *touch point* sangat memberi kesan positif dalam meringankan beban masyarakat nelayan terutama dalam menyelesaikan masalah kewangan dan keperluan untuk menangkap ikan dari semasa ke semasa. Apatah lagi ketika PKP, melalui bantuan-bantuan yang diterima itu ianya begitu melegakan dan dapat menyelesaikan masalah mereka walaupun untuk jangka masa yang pendek. Sebenarnya, bantuan kerajaan kepada nelayan tidak hanya mensasarkan kepada sesuatu perkara, tetapi ia berupaya bantuan yang berantailan antara satu sama lain. Ini bertujuan memberi kemudahan dan keselesaan kepada nelayan untuk menjalani kehidupan dan rutin harian mereka khususnya aktiviti menangkap ikan. Oleh sebab itu, apabila nelayan menerima bantuan dalam bentuk wang tunai, peralatan penangkapan ikan, bot dan sebagainya termasuk diberi latihan tertentu melalui kursus-kursus kemahiran, semua itu bertujuan memberi semangat dan motivasi kepada mereka untuk lebih tekun bekerja dan turun ke laut untuk menangkap ikan.

Atas sebab itu, bantuan kerajaan adalah secara berterusan dan berkaitan antara satu sama lain kepada masyarakat nelayan dalam rantai aktiviti penangkapan ikan. Selain menerima ESHN, mereka turut diberi subsidi petrol atau diesel bagi kegunaan enjin atau jentera dalam menangkap ikan, bantuan *touch point* dan lain-lain. Apabila mereka turun ke laut menangkap ikan, hasil yang diperolehi melayakkan mereka untuk menerima IHTI berdasarkan jumlah tangkapan yang diisytiharkan kepada LKIM. Secara ringkasnya, semua bantuan yang

diterima itu memberi semangat dan motivasi kepada nelayan untuk lebih tekun bekerja dan meningkatkan hasil tangkapan masing-masing. Berdasarkan kepada semua bantuan yang diterima, maka tiada sebarang alasan kepada nelayan untuk tidak turun ke laut menangkap ikan kecuali keadaan cuaca tidak mengizinkan.

Dengan kata lain, MAFI dan LKIM sangat prihatin dan komited dengan nasib dan kebajikan nelayan. Justeru, LKIM berupaya menyampaikan perkhidmatan yang terbaik kepada masyarakat nelayan walaupun berhadapan dengan pelbagai kesukaran khususnya dalam tempoh PKP. Justeru, Ketua Pengarah LKIM menzahirkan rasa berpuas hati dengan komitmen warga LKIM dalam menjalankan pelbagai aktiviti dan program pembangunan demi manfaat masyarakat nelayan di seluruh negara dan pemegang taruh. Justeru, beliau berharap seluruh warga kerja LKIM berupaya mengamalkan budaya kerja cemerlang dan berprestasi tinggi serta menjadikan semangat kerja berpasukan dan gerak kerja yang berintegriti sebagai pedoman bagi menjayakan setiap perancangan dan inisiatif kerajaan dengan cekap dan berkesan selaras dengan fungsi dan peranan LKIM dalam memajukan sosio-ekonomi nelayan dan sektor perikanan diteruskan pada tahun-tahun mendatang (Laporan Tahunan LKIM, 2020).

Selain bantuan berbentuk wang tunai, keperluan peralatan menangkap ikan dan latihan kemahiran, pihak LKIM turut memberi perhatian kepada usaha membina, membaiki dan menaiktaraf jeti, pelabuhan dan kompleks pendaratan ikan serta membina pasar nelayan supaya nelayan selesa dan mudah melakukan kerja mereka termasuklah menjual hasil tangkapan masing-masing dengan mudah dan selesa. Sebenarnya, kemudahan asas dan prasarana begitu diperlukan oleh nelayan kerana tidak semua kawasan nelayan mempunyai kemudahan yang sama. Justeru, pelbagai keperluan dikemukakan oleh nelayan berdasarkan kepada keadaan dan keperluan semasa untuk dipertimbang dan dilaksanakan LKIM mahu pun agensi-agensi kerajaan yang lain dan juga pihak swasta.

Jadi, secara umumnya pelaksanaan program bantuan di sudut masyarakat nelayan berupa suatu keperluan walaupun ada ketikanya meletakkan situasi masyarakat nelayan itu berada dalam keadaan sangat bergantung kepada bantuan kerajaan. Namun, inilah hakikatnya kerana kehidupan masyarakat nelayan banyak bergantung kepada dasar dan program kerajaan untuk meneruskan kelangsungan hidup. Namun, kebergantungan masyarakat nelayan kepada bantuan kerajaan bukanlah sepenuhnya atau sepanjang masa. Akan tetapi, sewaktu dihimpit kesulitan dan kesusahan misalnya dalam tempoh kritikal seperti PKP dan di luar musim menangkap ikan, maka majoriti masyarakat nelayan sangat mengharapkan bantuan kerajaan untuk kelangsungan hidup. Atas sebab itu, masyarakat nelayan sangat mengharapkan kerajaan menilai semula dan menambah baik dasar-dasar yang telah dilaksanakan termasuklah meningkat jumlah peruntukan yang disediakan demi kepentingan masyarakat nelayan.

Daripada apa yang telah dibincangkan di atas, dari sudut yang lain, maka dapat dirumuskan bahawa pelaksanaan program bantuan itu merupakan keprihatinan kerajaan kepada masyarakat nelayan. Sebenarnya, kerajaan cukup prihatin dan peka dengan masalah yang dihadapi oleh masyarakat nelayan. Tidak keterlaluan jika dikatakan masyarakat nelayan sangat bernasib baik berbanding kumpulan masyarakat lain di negara ini kerana menerima pelbagai bentuk bantuan yang bernilai ratusan juta ringgit setiap tahun. Atas sebab itu, tiada sebarang alasan yang kukuh jika masyarakat nelayan menuduh kerajaan tidak membantu dan prihatin terhadap masalah dan nasib mereka.

Dalam konteks dasar awam, dari segi outputnya, kerajaan sudah menyediakan banyak bantuan kepada masyarakat nelayan berdasarkan tuntutan atau permintaan yang disuarakan.

Manakala, dari outcomes pula matlamat akhir dasar sebenarnya adalah bertujuan mencapai kesejahteraan dan membentuk kegembiraan (*happinest*) dalam kalangan masyarakat nelayan. Jadi, pelaksanaan program bantuan itu dapat meningkatkan kualiti hidup masyarakat nelayan. Atas sebab itu, kerajaan sentiasa memberi tumpuan ke arah memperbaiki beberapa perkara yang berkaitan dengan kualiti hidup nelayan seperti menyediakan skim insurans perlindungan kepada masyarakat nelayan; menggalakkan masyarakat nelayan untuk mengekalkan perpaduan kaum; mengingatkan masyarakat nelayan agar menjaga kebersihan dan kesihatan diri untuk mencegah penyakit berjangkit; dan membuka peluang pendidikan untuk semua lapisan masyarakat nelayan tanpa mengira kaum dan agama. Apabila kualiti hidup itu dapat ditingkatkan, ia secara langsung meningkatkan kepercayaan masyarakat nelayan kepada kerajaan terutama dalam menghadapi PRU-15.

Berkaitan dengan pelaksanaan program bantuan seperti dinyatakan di atas, masyarakat nelayan mesti yakin terhadap keupayaan LKIM dalam menyalurkan bantuan kepada mereka. Kepercayaan ini dapat membuktikan bahawa LKIM dan PNK berupaya melaksanakan tanggungjawab dengan baik dalam menyampaikan perkhidmatan yang cekap dan berkesan ke arah menyelesaikan masalah nelayan. Dengan kata lain, LKIM dan PNK memainkan peranan penting dalam proses pengagihan dan penyaluran bantuan kepada nelayan. Semua urusan ini lebih mudah kerana tidak banyak karenah birokrasi yang menyulitkan nelayan. Justeru, berdasarkan kepada penilaian yang diberi, ia memberi gambaran positif terhadap imej dan kredibiliti LKIM dan PNK dalam berurusan dengan masyarakat nelayan di negara ini.

RUMUSAN

Berdasarkan kepada apa yang telah dibincangkan di atas, maka secara jelas menunjukkan bahawa pelaksanaan dasar dan program bantuan kepada nelayan itu merupakan suatu keperluan khususnya untuk jangka pendek kepada kumpulan masyarakat ini walaupun ada yang bersifat berpanjangan seperti ESHN. Namun, program bantuan itu perlu disemak semula. Tujuan semakan semula ini bukan sahaja untuk memperbaiki dari segi kuantiti, kualiti dan sistem penyampaian, tetapi kesan daripada pelaksanaan dasar dan program bantuan itu dapat meningkatkan produktiviti dalam kalangan masyarakat nelayan.

Oleh itu, sistem rekod bagi aktiviti nelayan perlu dikemas kini berkaitan hasil tangkapan dan aktiviti menangkap ikan yang dijalankan, di mana sekaligus dapat memantau produktiviti mereka. Aktiviti menangkap ikan secara harian perlu direkodkan oleh kaunter LKIM/jeti pendaratan bagi tujuan pembayaran IHTI. Langkah ini bertujuan bagi memastikan setiap nelayan yang menerima bantuan daripada pihak LKIM sentiasa berusaha untuk meningkatkan hasil tangkapan mereka. Berkaitan cadangan di atas, langkah menyemak status nelayan berdaftar dengan PNK untuk proses menjimatkan kewangan bagi yang tidak produktif. Dengan kata lain, perlu diwujudkan pengkalan data yang terkini bagi mengenal pasti pihak yang tidak layak sepenuhnya untuk menerima bantuan. Ianya selaras dengan dasar kerajaan yang berusaha untuk mengurangkan ketirisan dan penyelewengan berkaitan peruntukan bantuan yang disediakan.

Seterusnya, pihak LKIM boleh memberi anugerah dan pengiktirafan kepada nelayan yang menunjukkan prestasi yang baik dari segi tangkapan, jualan, produk dan kecemerlangan dalam bidang keusahawanan yang diceburi dengan mengiktiraf mereka sebagai Tokoh Nelayan Cemerlang. Kaedah ini secara tidak langsung boleh meningkatkan motivasi para nelayan untuk meningkatkan hasil tangkapan dan mempelbagaikan produk mereka melalui inovasi dan kreativiti yang sangat penting dalam bidang keusahawanan.

Justeru, MAFI dan LKIM juga dicadangkan untuk memperhalusi dasar dan program yang benar-benar perlu/signifikan kepada nelayan yang memenuhi kriteria yang disebutkan di atas bagi mengelak ketirisan dan pembaziran. Program dan bantuan yang disampaikan oleh pihak LKIM hendaklah diarahkan kepada golongan sasaran yang betul-betul memerlukan bantuan. Oleh itu, kajian tinjauan atau kaji selidik perlu dilakukan bagi mendapatkan maklum balas program dan dasar yang dilaksanakan oleh kerajaan melalui LKIM agar dapat memberi input penting dan menepati kehendak masyarakat nelayan yang layak menerima bantuan dan sebagainya daripada pihak kerajaan.

Ringkasnya, berhubung dengan perkara-perkara disebutkan di atas, dicadangkan supaya LKIM boleh mengadakan perbincangan dengan menjemput pakar-pakar mengikut bidang dari kalangan profesional dan pengamal industri yang berjaya bagi membincangkan dasar dan pembentukan program bagi meningkatkan sosio-ekonomi golongan nelayan. Sesi kerjasama antara LKIM dan pihak profesional terbabit dijangka dapat menjayakan program dan dasar yang dilaksanakan secara lebih berkesan dan cekap terutama dalam proses penyampaian perkhidmatan kepada nelayan.

RUJUKAN

- Hassan Omar. 2021. Nelayan Lega Dibenarkan Ke Laut. *Berita Harian* (02 Jun).
- Junhairi Alyasa. 2020. Covid-19: Perintah Kawalan Pergerakan di Seluruh Negara Bermula 18 Mac. *Sinar Harian* (16 Mac).
- Lembaga Kemajuan Ikan Malaysia (LKIM). 2021. *Citra Kejayaan LKIM: Lima Dekad Satu Azam*. Puchong: Lembaga Kemajuan Ikan Malaysia.
- Lembaga Kemajuan Ikan Malaysia (LKIM). *Laporan Tahunan 2014, 2015, 2016, 2017, 2018, 2019 dan 2020*. Diakses dari <https://www.lkim.gov.my/laporan-tahunan>. (28 Ogos 2022).
- Malaysia. 1985. *Akta Perikanan 1985 (Akta 317)*. Kuala Lumpur: Percetakan Nasional.
- Mohamad Hussin. 2018. Kebajikan Nelayan Terbelah. *Harian Metro* (30 Mac).
- Rusnan Mustafa. 2017. Pelbagai Dasar, Program Dirangka Bela Nelayan. *Utusan Borneo*. (01 Mei).
- Zanariah Abd Mutalib & Nor Azizah Mokhtar. 2020. COVID-19: Nelayan Dibenar Ke Laut. *Berita Harian* (21 Mac).

Kepincangan Trend Pakaian Cara Islam dalam Kalangan Wanita Islam

Masroha bt Sepian
Universiti Malaysia Kelantan
masrohasepian@yahoo.com.my

Nur Azuki Yusuff
Universiti Malaysia Kelantan
nurazuki@umk.edu.my

ABSTRAK

Pakaian cara Islam jelas dimaktubkan dalam al-Quran yang merupakan kewajipan terhadap Wanita Islam. Namun begitu, trend pakaian cara Islam kurang diperkasakan mengikut peraturan berpakaian patuh syariah. Ini memandangkan sebilangan besar wanita Islam memilih pelbagai trend dalam aktiviti seharian. Oleh itu, objektif kajian ini adalah untuk mengenal pasti trend pakaian wanita Islam. Kajian ini menggunakan kaedah kuantitatif yang melibatkan seramai 220 orang sampel. Soalan kaji selidik dianalisis menggunakan data perisian SPSS. Dapatan kajian menunjukkan trend pakaian ranggi dan ringkas menjadi pilihan utama. Secara keseluruhannya, kajian ini signifikan kepada masyarakat tentang kepentingan garis panduan menutup aurat dalam mengatasi kepincangan dalam trend pakaian kalangan wanita Islam.

Kata Kunci: *aurat, tuntutan syariah, jaminan keselamatan, penguatkuasaan*

ABSTRACT

The trend of Islamic clothing is clearly enshrined in the Qur'an, which guides Muslim women. However, according to Shariah-compliant dress regulation, the trend of Islamic attire is less powerful. This is due to the fact that many Muslim women choose to follow various trends in their everyday lives. Therefore, the objective of this study is to identify Muslim women's clothing trends. This study employs a quantitative approach with a sample size of 220 participants. SPSS software was used to study survey questions. According to the study's findings, the trend of elegant and simple clothing is the most popular choice. Overall, this study is essential to society in terms of the necessity of standards for covering private parts in overcoming infirmity in Muslim women's dress trends.

Key Word: *awra, syariah principle, safety assurance, enforcement*

PENGENALAN

Trend pakaian yang dipakai dalam kehidupan seharian oleh wanita Islam tidak selari dengan pengetahuan dan kefahaman agama Islam. Trend pakaian yang tidak selari dengan ajaran Islam ialah pakaian yang tidak patuh syariah. Trend pakaian tersebut ketat, sempit, sendat, nipis sehingga menampakkan bentuk tubuh badan (Agus Salim HR, Sulaeman Masnan & Mardiah, 2020). Kecelaruan trend pakaian yang tidak patuh syariah terbawa-bawa di dalam kehidupan seharian.

Trend pakaian yang ditonjolkan dalam kalangan wanita Islam menunjukkan mereka tidak jelas dengan aturan pakaian patuh syariah. Sesuai dengan kajian lepas mendapati pemahaman terhadap aurat dalam Islam dalam kalangan wanita Islam adalah tidak selari dengan amalan menutup aurat (Nuraleyah Abdul Hamid, Latifah Abdul Majid & Mohd Arif Nazri, 2019; Nurul Fatin Adawiyah Suhaimi, 2018). Terdapat kajian yang menyatakan bahawa pemahaman terhadap trend pakaian menutup aurat dipengaruhi oleh beberapa faktor iaitu latar

belakang pendidikan (sekolah, madrasah, pesantren) dan faktor persekitaran (Alfi Hidayah, 2019). Terdapat pelbagai trend pakaian yang menarik minat wanita Islam. Trend pakaian yang dipilih menepati cita rasa dengan penampilan pelbagai gaya. Berdasarkan kajian Alfi Hidayah (2019) pemilihan trend pakaian patuh syariah berada pada tahap yang sangat rendah.

Trend pakaian Islam adalah terbuka dengan syarat tidak melanggar prinsip-prinsip (Mohd Asri Zainul Abidin, 2010). Islam memberikan ketetapan yang begitu jelas dalam Al-Quran sebagai panduan, namun fenomena yang wujud terlalu banyak kepincangan dalam amalan berpakaian dalam kalangan wanita Islam yang tidak selari dengan ajaran dalam Al-Quran (Ahwy Oktradiksa, 2013; Wati Nafisatur Riyadloh, 2015). Penetapan cara berpakaian patuh syariah dapat memberi penguatkuasaan kepada diri sendiri dalam menentukan trend pakaian dalam kehidupan seharian. Walaupun trend pakaian yang dipilih lebih kepada berfeyen namun apa yang penting ialah trend pakaian yang dipakai lebih kepada menjaga maruah dan menepati etika pakaian patuh syariah.

KAJIAN LITERATUR

Kajian oleh Asmawati Suhid (2017); Asmawati Suhid et al. (2013) menyatakan maksud aurat ialah seluruh tubuh badan wanita kecuali muka dan kedua-dua tapak tangan". Manakala "pakaian menutup aurat" menurut syariat Islam merujuk pakaian wanita Islam yang menutupi seluruh tubuh kecuali muka dan kedua-dua tapak tangan. Selain itu, pakaian tersebut tidak ketat, sempit, sendat, nipis sehingga menampakkan bentuk tubuh badan (Mansor Sulaiman, Zailin Shah Yusoff, Ahmad Murad Zainuddin, Ahmad Irfan Ikmal Hisham & Abdullah Long, 2017; Mashitah Sulaiman, Mohd Nazir Ahmad, Zainora Daud, Ros Aiza Mohd Mokhtar & Abd Hakim Mohad, 2020; Muhamad Zahiri Awang Mat, Zariah Zakaria, Zabariah Ahmad & Siti Salwa Md.Sawari, 2017).

Merujuk kepada kajian yang dijalankan oleh Radhiya dan Abdullah Hakam Shah (2014) faktor dalaman sangat penting dalam mempengaruhi trend pakaian. Hal ini kerana kurangnya kesedaran keislaman, serta tidak berani mengambil keputusan drastik dalam melakukan perubahan ke arah yang lebih positif.

Wanita lebih cenderung untuk terpengaruh oleh perkembangan trend semasa dalam memilih trend pakaian. Mereka yang cenderung untuk terikut-ikut dengan trend semasa masih belum stabil dari segi emosi dan pemikiran kerana sering mencuba trend baharu, ingin selalu menonjolkan diri, ingin kelihatan kelainan pada setiap masa dan pelbagai lagi niat di sebalik trend pakaian (Amina Ziad, 2017; Ayu Nadia, 2020). Jadual 1 menunjukkan trend pakaian yang dipakai oleh responden dalam kehidupan seharian.

rasmi untuk wanita dan dipakai oleh semua bangsa dan merupakan pakaian rasmi penduduk Malaysia (Nur Farhana M Sukeri, 2019).

Kajian oleh Selfa Nur Insani (2018); Shamshuritawati Sharif et al. (2017) baju kurung digunakan untuk menghadiri majlis perkahwinan, majlis agama dan majlis rasmi. Pakaian ini bukan hanya digunakan untuk pakaian pejabat tetapi baju kurung juga merupakan pilihan wanita untuk kelihatan bergaya bagi apa-apa sahaja upacara, seperti majlis perkahwinan dan perayaan. Secara amnya, wanita Melayu memakai baju kurung sebagai pakaian tradisi ini termasuk pakaian rasmi pelajar di sekolah rendah dan di sekolah menengah. Terdapat dua jenis baju kurung, iaitu Baju Kurung Teluk Belanga dan Baju Kurung Cekak Musang. Dalam mengkomersialkan baju kurung, pembuatnya kadang-kadang mengubah sifat tradisional pakaian. Kajian tentang seni tradisional baju kurung Aris, Nawawi dan Ibrahim (2016) memakai sering mengabaikan pengubahsuaian yang dibuat kepada baju kurung sehinggakan muncul pelbagai jenis model baju kurung tetapi pengubahsuaian masih lagi mengekalkan imej baik pemakainya.

Trend pakaian yang mendapat sambutan ramai ialah ranggi. Wanita yang memilih trend ini beranggapan bahawa lebih bergaya dan ringkas (Ahmad Marzuki Mohamad & Betty Azura Muhamad Radzi Noor, 2011; Solihin, 2020). Pakaian dikatakan ringkas kerana bertudung hanya menutup kepala dan tidak menutup sampai dada atau dikenali sebagai istilah ranggi. Berseluar panjang hingga menutup bentuk kaki namun masih menampakkan bentuk kaki (Eko Setiawan, 2016). Berpakaian sebegini akan kelihatan bergaya dan moden (Siti Rohmah Soekarba & Nadya Karima Melati, 2017). Kajian oleh Tasnim Rosli, Muniandy & Kamarul Azmi Jasmi (2019) pengaruh trend pakaian memberi kesan negatif kepada masalah sosial namun kurang kajian berkenaan mengapa wanita Islam lebih cenderung untuk memilih trend pakaian yang lebih ranggi dan temporer. Berdasarkan pemerhatian pengkaji trend yang menjadi pilihan wanita juga trend pakaian suai dan padan (*mix and match*). Trend pakaian sebegini sentiasa berubah-ubah tanpa mengira situasi berdasarkan keselesaan sendiri. Kadang-kadang pakaian yang dikatakan terlalu ringkas adalah seperti berbaju kemeja-T, berseluar track dan berskirt labuh. Berdasarkan kajian oleh Ahmad Marzuki Mohamad dan Noor Betty Azura Muhamad Radzi (2011); Rokiah Ismail (2003) fesyen utama yang sangat digemari oleh remaja ialah fesyen ringkas dan selesa menurut pandangan sendiri. Oleh sebab itu baju kemeja-T, berseluar trek, *skirt* labuh, dan pelbagai lagi trend dapat dilihat digayakan oleh remaja perempuan dan kelihatan terlalu ringkas.

Trend pakaian yang seterusnya ialah ketat dan menampakkan susuk badan. Trend berpakaian moden dan bergaya menutup seluruh tubuh daripada hujung kepala sampai hujung kaki, pakaian agak ketat sehingga menonjolkan bentuk dan potongan tubuh badan. Begitu juga tudung yang dipakai singkat sehingga menampakkan bentuk dada sudah dianggap menutup aurat (Ririn Hermaliyani, 2018). Kajian tentang pengaruh Islam Liberal oleh Jamaluddin dan Majid (2013); Sulis Rahayu (2019) menunjukkan pengabaian menutup aurat dalam kalangan remaja Islam sehinggakan mencetuskan trend pakaian berbaju-T lengan pendek dan bertudung kepala. Dalam kajian Solihin (2020) ditemukan permasalahan dalam trend pakaian, namun penekanan dari aspek faktor-faktor yang mendorong kepada permasalahan tersebut kurang diberi perhatian oleh pengkaji.

Trend seksi dan menonjol seperti bertudung singkat sehingga menampakkan bentuk dada merupakan trend yang tidak dapat dihindari oleh masyarakat moden sekarang ini (I Wayan Gede Lamopia & Wulandari Riza, 2018). Kajian menyatakan pengaruh trend pakaian seksi dalam iklan-iklan memberi pengaruh ikutan kepada wanita Islam (Fajar Maharani, Safa

Aqilla D & Salsabiela Aurelia P. B, (2020). Sesungguhnya kecenderungan model pemakaian yang tidak mengikut syariah Islam menunjukkan kelemahan moral masyarakat (Norliza Ahmad, 2008; Sarimah Nordin., Sulaiman Shakib Mohd Noor & Mohd Al'Ikhsan Ghazali, 2016). Hal ini sedemikian dapat mendorong seseorang untuk memilih trend pakaian yang melanggar syariah Islam sekiranya tidak dibendung dari awal (Santi Marito Hasibuan, 2019). Individu akan memilih trend berpakaian tidak menutup kepala. Trend tidak menutup kepala dengan tudung jauh menyimpang daripada syariat Islam. Jauh daripada aturan agama Islam dengan berpakaian ketat, menonjol potongan tubuh badan dan menampakkan aurat lengan sehingga tangan tidak ditutup dan memakai seluar ketat (Murtopo, 2017).

Berdasarkan huraian pada setiap trend pakaian tersebut maka dapat dirumuskan bahawa terdapat beberapa alasan yang mempengaruhi trend pemakaian menutup aurat dalam kalangan wanita Islam. Berdasarkan ilmu teologis, iaitu kewajipan beragama iaitu perintah wajib menutup aurat dengan sempurna mengikut standard dan syariat (Aker Rita Afroza, 2017). Sesuai dengan kajian yang dilakukan oleh Mohamad Muhaimin Mohamad Zaki (2017) bahawa seseorang itu yakin bahawa amalan baik dan amalan buruk yang dilakukannya di dunia ini akan mendapat balasan pada hari akhirat kelak.

Seterusnya alasan psikologis iaitu tidak lagi mementingkan amalan untuk berpakaian mengikut syariat tetapi memilih untuk berpakaian sebagai budaya dan kebiasaan. Apabila ditinggalkan amalan ini akan membuatkan hati tidak tenang. Bertepatan dengan kajian yang dilakukan oleh Asis (2018) wanita berpakaian disebabkan memenuhi keperluan tuntutan fesyen semasa sehingga ada pakaian yang melampaui persoalan agama. Fesyen juga bukan hanya tentang pakaian dan penampilan, tapi juga peranan dan makna pakaian dalam tindakan sosial (Nur Hikmah Yassintan, 2016).

KAEDAH KAJIAN

Kajian ini merupakan satu kajian kaedah kuantitatif. dapatan kajian yang berdasarkan data kuantitatif dianalisis menggunakan perisian “Statistical Package For Social Science” (SPSS) versi 20. Penyelidik memilih sampel seramai 220 orang responden dalam kalangan pelajar perempuan Islam Sekolah Menengah Kebangsaan. Populasi kajian ini adalah pelajar dalam kalangan pelajar wanita Islam tingkatan enam yang melibatkan beberapa sekolah di Kelantan. Pemilihan sekolah yang mempunyai pengurusan tingkatan enam diambil di pejabat Jabatan Pendidikan Negeri Kelantan. Jumlah populasi adalah dipilih dalam senarai pelajar tingkatan enam seramai 4404 orang. berdasarkan jadual Krejcie dan Morgan (1970).

Penyelidik menggunakan kaedah persampelan secara rawak untuk memilih sampel. Hal ini bermakna responden mempunyai kebarangkalian yang sama untuk menjawab soal selidik yang diedarkan. Responden kajian ini dilihat sesuai kerana terdapat kepincangan trend pakaian cara Islam yang tidak patuh syariah. Kecenderungan berpakaian patuh syariah disebabkan tuntutan undang-undang setempat. Menurut Bahrun Ali Murtopo (2017) dan Rasyidah (2017), lazimnya seseorang wanita Islam menutup aurat kerana mematuhi peraturan dan undang-undang sesebuah institusi.

Satu set borang soal selidik diberikan kepada subjek kajian untuk mendapatkan maklumat atau data yang diperlukan untuk memenuhi objektif kajian. Penggunaan borang soal selidik sebagai instrumen kajian merupakan kaedah yang paling berkesan. Mengandungi item-item yang memberikan kebebasan kepada responden untuk menyatakan jenis pakaian yang

sering dipakai oleh responden berdasarkan situasi dan aktiviti dihadiri dalam kehidupan seharian.

ANALISIS DATA KAJIAN

Analisis data pada bahagian ini mengandungi trend berpakaian berdasarkan situasi dan aktiviti oleh Wanita Islam. Dapatan kajian seperti dalam jadual 1.

Jadual 1. Trend Pakaian Pelajar Perempuan

Situasi Aktiviti	Muslimah		Bergaya dan Moden		Gaya Tradisi		Pilihan Sendiri		Ranggi dan Ringkas		Ketat		Pilihan Sendiri		Seksi Tidak BTudung	
	F	%	F	%	f	%	f	%	F	%	f	%	F	%	F	%
Keluarga	26	12	48	22	35	16	24	11	85	39	1	5	-	-	1	5
Kawan-kawan	22	10	27	12	12	5.5	34	16	121	55	2	1	2	1	-	-
Keluar	24	11	34	16	19	8.6	38	17	100	46	3	1	1	1	-	-
Kelas tambahan	36	16	19	8.6	116	53	27	12	21	9.5	1	1	-	-	-	-
Kenduri	34	16	73	33	107	49	4	1.8	1	0.5	1	1	-	-	-	-
Sekolah	44	20	14	16	157	71	1	0.5	4	1.8	-	-	-	-	-	-
Adik beradik	105	48	27	12	49	22	12	5.5	27	12	-	-	-	-	-	-

f = frekuensi ; %=peratusan

Berdasarkan analisis, trend pakaian ranggi dan ringkas iaitu seramai 121 orang (55%) semasa keluar dengan kawan-kawan. Hal ini kerana trend pakaian ranggi dikatakan ringkas hanya bertudung menutup kepala dan tidak menutup sehingga dada. Baju yang dipakai juga masih menampilkan alur bentuk lengan dan tubuh. Dapatan ini seiring dengan kajian Nozira Salleh (2021) menyatakan bahawa keghairahan Wanita Islam dalam mengejar fesyen terkini menyebabkan tabaruj dalam memilih trend pakaian.

Baju kurung merupakan trend pilihan kedua tertinggi iaitu seramai 116 orang (52%) dipakai semasa menghadiri kelas tambahan. Manakala pemilihan baju kurung untuk ke sekolah semasa sesi pengajaran dan pembelajaran seramai 157 orang (71%). Secara umum walaupun tidak terdapat aturan resmi dari universiti, mahasiswi muslimah majoriti menggunakan hijab dalam lingkungan kampus (Nurhasan, 2022). Hal ini kerana, memakai baju kurung hanya

memenuhi syarat dalam sesuatu institusi contoh sekolah. Selain itu sebagai tuntutan untuk ke majlis seperti kenduri. Dapatan ini dapat dikaitkan dengan kenyataan Shabana Yusoff et al. (2019) bahawa pakaian tradisional Melayu seperti baju kurung merupakan salah satu khazanah istimewa yang harus dikekalkan sebagai simbol identiti orang Melayu. Amalan memakai baju kurung sebagai baju seragam rasmi dapat mengekalkan budaya pakaian tradisional di era pemodenan fesyen ranggi.

Analisis menunjukkan hampir separuh daripada responden lebih selesa berbaju ranggi dan ringkas semasa keluar dengan kawan-kawan iaitu seramai 121 orang (55%), berbanding seramai 85 orang (39%) sewaktu keluar dengan keluarga. Selain itu, berbaju ranggi semasa keluar dari rumah untuk sebarang aktiviti ialah 100 orang (46%). Perbezaan yang ketara dari segi pemilihan trend mengikut situasi dan keadaan majlis atau aktiviti yang dihadiri menunjukkan bahawa wanita Islam mempunyai pengetahuan yang tinggi dalam memilih trend pakaian berdasarkan tempat dan dengan siapa mereka bersama-sama. Pemilihan pakaian dengan keluarga agak sopan menunjukkan wanita mengetahui batas aurat. Sesuai dengan kajian Arina Ulfa Musrifah (2022) menyatakan bahawa semakin tinggi pengetahuan dan pemahaman terhadap hukum menutup aurat maka semakin tinggi keupayaan dan kemahuan untuk memilih trend pakaian patuh syariah dalam sebarang situasi atau keadaan wanita akan sentiasa menjaga batas aurat.

Berdasarkan analisis menunjukkan bahawa responden memilih trend pemakaian muslimah iaitu seramai 105 orang (48%) dan 49 orang (22%) baju kurung untuk adik perempuan responden. Responden tidak menggalakkan adik beradik perempuan untuk memakai trend pakaian yang tidak patuh syariah. Hal ini menunjukkan bahawa pertimbangan mereka dalam memilih trend pakaian yang patuh syariah berada pada tahap tinggi. Nurhasan (2022) menyatakan bahawa tren pakaian bergantung kepada niat individu yang menggayakannya. Seseengah individu menggayakan sesuatu trend pakaian kerana mematuhi syariah dan ada yang menggayakan trend pakaian atas dasar tuntutan budaya sesuatu tempat.

HASIL DAPATAN DAN PERBINCANGAN

Kesimpulannya, kajian trend pakaian dalam kalangan wanita Islam adalah signifikan dengan kajian lepas. Dapatan kajian menunjukkan bahawa trend pakaian ranggi dan ringkas adalah pilihan trend pakaian tertinggi. Sesungguhnya, trend ini telah menjadi pilihan semasa keluar dengan kawan-kawan untuk melakukan pelbagai aktiviti. Manakala, hanya nilai peratusan 38.6% memilih trend pakaian ranggi sewaktu keluar dengan keluarga. Berdasarkan teori Erickson, identiti berlawanan dengan kekeliruan seseorang adalah mengikut faktor persekitaran. Manakala berdasarkan akseologi Islam, trend pakaian dipilih berada dalam ruang lingkup halal, haram, harus, sunat dan makruh. Hasil kajian menunjukkan, walaupun trend ranggi menjadi pilihan wanita Islam kini, namun trend ini masih memenuhi tuntutan syariah Islam. Hal ini seiring kajian Adheyatul (2019), majoriti wanita Islam memilih trend disebabkan memenuhi tuntutan agama Islam. Seterusnya, berdasarkan teori Tindakan Sosial iaitu Rasional Berorientasikan Nilai, wanita Islam memanfaatkan trend ranggi selagi menepati syariah tuntutan Islam. Namun begitu, tujuan trend ranggi dipilih kerana dipengaruhi oleh tuntutan sekeliling iaitu memenuhi kehendak fesyen semasa.

Manakala baju kurung merupakan trend pilihan kedua tertinggi iaitu lebih daripada separuh responden memakai baju kurung untuk menghadiri kelas tambahan. Manakala pemilihan baju kurung untuk ke sekolah semasa sesi pengajaran dan pembelajaran nilai peratusan 71.4%. Berdasarkan dapatan kajian tersebut pemilihan baju kurung atau baju

kebangsaan merupakan syarat untuk responden menghadiri kelas atau untuk ke sekolah sahaja. Trend pakaian baju kurung dapat dikaitkan juga dengan teori Tindakan Sosial iaitu Rasional Berorientasikan Nilai. Berdasarkan teori ini responden memilih trend baju kurung kerana tuntutan sekeliling iaitu pekeling yang dikeluarkan oleh pihak sekolah.

Trend pakaian untuk adik-adik perempuan ialah trend muslimah menjadi pilihan nilai peratusan 47.7%. Pemilihan baju kurung 22.3%. Manakala untuk trend baju seksi dan moden mempunyai peratusan rendah. Hal ini menunjukkan pemilihan trend pakaian patuh syariah mempunyai tahap yang rendah namun pemilihan trend untuk adik-beradik perempuan responden menunjukkan pemilihan trend patuh syariah berada pada tahap tinggi. Dapatan kajian ini menunjukkan responden mengetahui kewajipan menutup aurat sesuai dengan kajian lepas kewajipan menutup aurat berada pada tahap tinggi (Asmawati Suhid et al., 2013; Nurazzura Mohamad Diah, 2019). Perubahan trend pakaian ini kajian menunjukkan evolusi trend sentiasa berubah-ubah mengikut masa dan keadaan (Saniah Ahmad & Zairul Anuar Md. Dawan, 2020).

Keputusan kajian ini menunjukkan bahawa pematuhan terhadap etika berpakaian patuh syariah wanita Islam masih berada pada tahap rendah. Hasil kajian ini selari dengan beberapa kajian lalu yang menyatakan terdapat wanita Islam yang berpakaian muslimah, namun terdapat juga mahasiswi yang tidak memakai pakaian patuh syariat seperti memakai jilbab dan celana jeans dengan baju-T atau blaus bahkan ada pakaiannya yang ketat, nipis dan transperan (Sharifah Khatreena Nuraniah & Nurazzura Mohamad Diah, 2017; Tantri Puspita Yazid & Ridwan, 2017).

Selain itu, pemerhatian pengkaji mendapati, trend pakaian wanita Islam dapat dilihat apabila pakaian tradisional hanya dipakai oleh golongan muda pada waktu perayaan utama sahaja. Sesuai dengan dapatan kajian oleh Selfa Nur Insani, (2018); Shamshuritawati Sharif et al., (2017) tentang trend pakaian baju kurung yang kebanyakannya dipakai dalam majlis-majlis tertentu agar lebih bergaya dan elegan. Dapatan kajian juga mendapati baju kurung dipakai semasa di sekolah-sekolah. Berbeza pula dengan kenyataan Fatonah Nurdin, Hartati dan Selfi Mahat Putri, (2020) bahawa pemakaian baju kurung perlu dinormalisasikan. Hal ini kerana pemakaian baju kurung merupakan simbol jati diri muslimah Melayu sesuai dengan syariah Islam. Seiring dengan kenyataan Charles W. Morris dalam kajian Carr, Davies dan Lavin, (2009) bahawa pemakaian seharian melambangkan gaya hidup dan kehidupan sosial individu tersebut (Ivery, 2020, Lavin, A. M., Carr, D. L., & Davie, 2009).

Manakala trend pakaian selain baju kurung, iaitu pakaian suai dan padan merupakan pakaian pilihan harian responden. Kajian lepas menyatakan bahawa wanita cenderung untuk menggabungkan antara trend pakaian patuh syariah dan trend pakaian semasa dan moden (Akter, 2018; Wardah Nuroniyah, 2019).

KESIMPULAN

Berdasarkan kajian ini, dapat dirumuskan bahawa penjagaan aurat merupakan sebahagian daripada ajaran dan syariat Islam. Jadi tidak seharusnya ada pertikaian dari segi penutupan aurat dalam kalangan wanita Islam. Tidak ada sebab untuk mempertikaikan satu-satu peraturan yang dikuatkuasakan sedangkan peraturan undang-undang dibuat adalah untuk mengawal, menjaga dan menjamin keselamatan, khususnya keselamatan orang Islam sendiri. Wanita mempunyai perasaan dan naluri yang kuat untuk sentiasa bergaya dan kelihatan cantik. Perasaan ini memberi ruang kepada wanita Islam untuk bergaya sehingga mealnggar batas

syariah. Kehendak yang tidak dikawal oleh akal mengakibatkan keinginan untuk memakai pakaian yang nipis, yang menampakkan bahagian tubuh atau memakai pakaian ketat yang menampakkan bentuk badan.

Tuntas, kajian ini dapat dijelaskan melalui rangkuman *Strength, Weakness, Opportunity, dan Threat (SWOT)*. Kekuatan kajian ini adalah untuk mengenal pasti trend pakaian patuh syariah manakala, kelemahannya pula dapat dilihat bahawa wanita tidak akur dengan pematuhan trend patuh syariah dan terlalu mengikut peredaran fesyen sehingga mengabaikan peraturan yang telah digariskan dalam Al – Quran. Walaubagaimanapun, kajian ini membuka ruang untuk membangunkan inovasi dalam mencipta trend pakaian patuh syariah tanpa mengetepikan garis panduan yang disyariatkan. Selain itu, ancaman yang wujud dalam trend pakaian dipengaruhi oleh pemikiran sekular dan garapan idea yang mencipta trend pakaian tidak patuh syariat.

RUJUKAN

- Agus Salim HR., Sulaeman Masnan, & Mardiah. (2020). Analisis Motivasi Konsumen dalam Proses Keputusan Pembelian Busana Syar’I terhadap Mahasiswa Manajemen 2016 Fakultas Ekonomi. *Jurnal Ilmu Manajemen*, 4(1), 13–22.
- Ahmad Marzuki Mohamad, & Betty Azura Muhamad Radzi Noor. (2011). *Persepsi Pelajar Wanita Islam UTM terhadap Fesyen Terkini dan Tuntutan Menutup Aurat*. Retrieved from <https://scholar.google.com/scholar/q-fiqah/wanita/btnG.html>
- Ahwy Oktradiksa. (2013). *Estetika Berjilbab pada Wanita Muslimah (Kajian Sosial dan Pendidikan Islam)*. *Tarbiya Tuna*. Retrieved from <http://jurnal.umngl.ac.id/jurnal/index.php>
- Aisyia Al Islami. (2020). *Fenomena Hijab Fashion Perspektif Fikih Sosial*. Doctoral dissertation, Universitas Islam Negeri Alauddin Makassar.
- Akter Rita Afroza. (2017). Assertion of Wearing Hijab in the Community: an Analysis. *American Scientific Research Journal for Engineering, Technology, and Sciences*, 29(1), 340–347.
- Akter, M. (2018). Male Perception on Female Attire: An analysis on the Campus of the University of Dhaka. *Global Journal of Human-Social Science: C Sociology & Culture Sociology & Culture*, 18(2), 1–8.
- Alfi Hidayah. (2019). *Perubahan Pola Menutup Aurat di kalangan Mahasiswa Fakultas Ushuluddin dan Filsafat (UIN Ar-Raniry Banda Aceh)*. Doctoral dissertation, Universitas Islam Negeri Ar-Raniry Banda Aceh.
- Amina Ziad. (2017). *American Muslim Women’s Understandings of Hijab and Modesty*. Doctoral dissertation, Wellesley College.
- Arina Ulfa Musrifah. (2022). *Hubungan Pengamalan Nilai-Nilai Pai Dengan Motivasi Mendesain Busana Muslimah Siswa Kelas XI Tata Busana Smk N 1 Sewon Bantul*. *Learning and Teaching of Islamic Religious Education*, 1(1), 1-22.
- Asis Patta Hindi. (2018). Makna Berhijab bagi Muslimah: Sebuah Persepsi Mahasiswa Fisip Universitas Muhammadiyah Kendari. *Jurnal Dakwah Tabligh*, 18(2), 92–106.
- Asliza Aris., Norwani Md Nawawi, & Suzlee Ibrahim. (2016). The Aesthetic Principles of Baju Kurung. In *Proceedings of the Art and Design International Conference* (pp. 273–281). Springer, Singapore.
- Asmawati Suhid. (2017). Tahap Pengetahuan Pelajar tentang Konsep Menutup Aurat: Suatu tinjauan umum. *O-JIE: Online Journal of Islamic Education*, 1(1).
- Asmawati Suhid., Mohd Faizal Mohd Zain., Abdul Muhsin Ahmad, & Mohd Aderi Che Noh. (2013). Tahap Pengetahuan Pelajar tentang Konsep Menutup Aurat: Suatu Tinjauan

- Umum. *The Online Journal of Islamic Education*, 1(1), 40–47.
- Ayu Nadia. (2020). Hubungan Antara Konsep Diri dengan Gaya Hidup Hedonisme Pada Mahasiswa Jurusan Seni Tari Universitas PGRI Palembang. Doctoral dissertation, UIN Raden Fatah Palembang.
- Bahrin Ali Murtopo. (2017). Etika Berpakaian dalam Islam: Tinjauan Busana Wanita Sesuai Ketentuan Islam. *Jurnal Pemikiran Keislaman Dan Kemanusiaan*, 1(2), 243–251.
- Eko Setiawan. (2016). *Fenomena Jilbab Dalam Perspektif Sosial* (2).
- Fajar Maharani., Safa Aqilla D., & Salsabiela Aurelia P B. (2020). Representasi Male Gaze terhadap Perempuan dalam Iklan Dot Dodo. *Jurnal Audiens*, 1(2), 199–205.
- Fatonah Nurdin., Hartati, & Putri Selfi Mahat. (2020). Baju Kurung Pakaian Tradisional Perempuan Melayu Jambi. *Jurnal Ilmiah Universitas Batanghari Jambi*, 20(3), 751–756.
- Fitry Adheyatul. (2019). *Jilbab antara Ibadah dan Gaya (Studi Fenomenologi tentang Alasan Polisi Wanita Memakai Jilbab di Polres Baubau)*. Doctoral dissertation, Universitas Islam Negeri Alauddin Makassar
- I Wayan Gede Lamopia, & Wulandari Riza. (2018). Pemakaian Seragam Seksi Bagi Operator Perempuan Spbu 54.801.50 Denpasar. *Jurnal Asketik*, 1(2), 101–110.
- Ivery Gwendolyn. (2020). *Teacher Perceptions of How Attire Affects Student Behavior and Academic Performance: A Case Study*. Concordia University (Oregon). Retrieved from Doctorate of Education Program.
- Krejcie, R. V., & Morgan, D. W. (1970). *Educational and Psychological Measurement*. University of Minnesota, Duluth.
- Lavin, A. M., Carr, D. L., & Davie, T. L. (2009). The male professor's attire and student perceptions of instructional quality. *Research in Higher Education Journal*, 4, 1–15.
- Mansor Sulaiman., Zailin Shah Yusoff., Ahmad Murad Zainuddin., Ahmad Irfan Ikmal Hisham, & Abdullah Long. (2017). Pemeliharaan Masalah di Sebalik Pensyariaan Konsep Berpakaian Wanita Menurut Islam. *International Journal of Humanities Technology and Civilization*, 2(1), 62–72.
- Mashitah Sulaiman., Mohd Nazir Ahmad., Zainora Daud., Ros Aiza Mohd Mokhtar, & Abd Hakim Mohad. (2020). Kreativiti, Inovasi dan Kepatuhan Syariah dalam Fesyen Busana Muslimah dalam Kalangan Usahawan Wanita Melayu di Selangor. *Jurnal Sains Insani*, 5(10), 51–64.
- Mohamad Muhaimin Mohamad Zaki. (2017). Analisis Pengaplikasian Amalan Qalbu dalam Pengajaran dan Pembelajaran. *Jurnal 'Ulwan*, 19–42
- Mohd Asri Zainul Abidin. (2010). *Mengemudi Bahtera Perubahan Minda*. Utusan Publishers & Distributors Sdn. Bhd
- Muhamad Zahiri Awang Mat., Zariah Zakaria., Zabariah Ahmad, & Siti Salwa Md.Sawari. (2017). Kaedah Meningkatkan Kesedaran Menutup Aurat dalam Kalangan Murid Sekolah Rendah. *Malaysian Journal for Islamic Studies*, 2, 1–8.
- Norliza Ahmad. (2008). *Kesedaran Menutup Aurat dalam Kalangan Pelajar Tahun Empat*. Retrieved from Universiti Teknologi Malaysia.
- Nozira Salleh. (2021) *Tabarruj dan Fesyen Pakaian Muslimah pada Zaman Kini*. Akademika 91(1), 2021: 109-118 <https://doi.org/10.17576/akad-2021-9101-09>
- Nur Farhana M Sukeri. (2019). The Significance of Subculture among Malaysian Teenagers in 2015-2016. *Ideology*, 3(2018), 56–58.
- Nurhasan. N. (2022). Studi Motivasi dan Trend Berpakaian Wanita Muslimah dalam Mengenakan Hijab pada Mahasiswi di Universitas Sriwijaya. *Jurnal Pendidikan dan Konseling*, 4(5), 1232-1239.

- Nur Hikmah Yassintan. (2016). *Fenomena Fashion Hijab Pada Kalangan Remaja Di Kota Bandung: Studi Fenomenologi Trend Fashion Hijab Pada Mahasiswi Jurusan Ilmu Komunikasi Universitas Pasundan*. Doctoral dissertation, Universitas Pasundan.
- Nuraleyah Abdul Hamid., Latifah Abdul Majid, & Mohd Arif Nazri. (2019). Kefahaman Hadis Musykil oleh Golongan Islam Liberal. *Journal of Al-Quran and Al-Sunnah*, 4(1), 24–31.
- Nurazzura Mohamad Diah. (2019). Physical Changes as Part of Midlife Crisis: The Case of Urban Malay Women. *Jurnal Sains Sosial@ Malaysian Journal of Social Sciences*, 3(1), 67–76.
- Nurul Fatin Adawiyah Suhaimi. (2018). *Pandangan Mahasiswa Institut Pengajian Islam (INSPI) Terengganu, Malaysia tentang Menutup Aurat (Studi Terhadap Surat Al-Ahzab:59)*. Universitas Islam Negeri Sumatera Utaramedan.
- Pratiwi S R. (2020). “Bagaimana Mereka Mengubahku?” (*Interpretative Phenomenological Analysis tentang Rekonstruksi Identitas pada Muslimah Bercadar*). <https://doi.org/10.15294/intuisi.v12i1.18326>
- Puspita Yazid Tantri, & Ridwan. (2017). Proses Persepsi Diri Mahasiswa dalam Berbusana Muslimah. *Jurnal An-Nida'*, 41(2), 193–201.
- Radhiya Bustan, & Abdullah Hakam Shah. (2014). Motivasi Berjilbab Mahasiswi Universitas Al Azhar Indonesia (UAI). *Jurnal Al-Azhar Indonesia Seri Humaniora*, (3), 164–176.
- Rasyidah. (2017). Dakwah Struktural Pakaian Muslimah di Kelantan-Malaysia. *Jurnal Studi Gender dan Islam Serta Perlindungan Anak*, 6(1), 1–15.
- Ratna Wijayanti. (2017). Jilbab Sebagai Etika Busana Muslimah dalam Perspektif Al- Qur'an. *Cakrawala: Jurnal Studi Islam*, XII(2), 151–170.
- Ririn Hermaliyani. (2018). Perspektif Hukum Islam terhadap Praktek Jual Beli Pakaian Seksi (Studi Kasus di Pasar Malingping Kecamatan Malingping Kabupaten Lebak). Universitas Islam Negeri “Sultan Maulana Hasanuddin” Banten.
- Rokiah Ismail. (2003). Fesyen Pakaian Remaja : Mengapa Perlu “Ranggi”? In *Prosiding Persidangan Kebangsaan* (p. 20).
- Saniah Ahmad, & Zairul Anuar Md. Dawan. (2020). Revolusi, Fungsi dan Trend Pemakaian Tudung di Malaysia. *Gendang Alam*, 10.
- Santi Marito Hasibuan. (2019). Fashion Style Spg Dalam Memasarkan Produk Ditinjau dari Perspektif Al-Qur'an. *Journal of Chemical Information and Modeling*, 53(9), 1689–1699.
- Sarimah Nordin., Sulaiman Shakib Mohd Noor., & Mohd Al'Ikhsan Ghazali. (2016). Fenomena Tabarruj Masa Kini dalam kalangan Wanita Muslimah. In *Dialog Keamanan: Satu Sorotan dari Kacamata Al-Quran* (pp. 1–15)
- Selfa Nur Insani. (2018). Baju Kurung Sebagai Pakaian Adat Suku Melayu di Malaysia. *Wacana Seni Journal of Arts Discourse*, 1–12
- Shabana Yusoff, Mohd Iskandar Mohd Yatim, & Nor Syamiza Ab Rashid (2019). *Pemilihan inspirasi Baju Kurung Tradisional menjadi Pakaian Kontemporari Masyarakat*.
- Shamshuritawati Sharif., Suzilah Ismail, & Zurni Omar. (2017). High Dimensional Quality Control Chart: A Case Study of “Baju Kurung” Manufacturing Industry. *International Journal of Applied Engineering Research*, Volume 12(12), 5491–5494.
- Sharifah Khatreena Nuraniah. Syed Faizuddin Putra Jamalullail, & Nurazzura Mohamad Diah. (2017).
- New Look, New Identity: Re-Inventing Muslim Women Through Fashion. In *Social Sciences Postgraduate International Seminar (Spsis) 2017* (pp. 44–51)
- Siti Rohmah Soekarba, & Nadya Karima Melati. (2017). Muslim Women In Middle Class Indonesia: Postfeminist Analisis Of Women Wearing Veil In Depok (2010-2016). *International Review of Humanities Studies*, 2(1), 75–91.

- Solihin. (2020). Pembinaan Etika Berpakaian Islami bagi Siswa SMK Ikhlas Jawilan Kabupaten Serang. *Jurnal Aksioma Ad-Diniyyah: The Indonesian Journal of Islamic Studies*, 8(2).
- Sulaiman Sheu Adua. (2018). Dichotomy Between Hijab and Niqab in Islam. *Academic Research International*, 9(6), 121–129.
- Sulis R. (2019). *Peran Pembelajaran Aqidah Akhlak terhadap Etika Busana Muslim di Ma Muhammadiyah 01 Tegalombo Tahun Pembelajaran 2018/2019*. Doctoral dissertation, Universitas Muhammadiyah Ponorogo.
- Tasnim Rosli., Muniandy Yogenathan, & Kamarul Azmi Jasmi. (2019). Media Sosial dan Impak Negatif Menurut Islam. *Utm*, 1(2003), 61–79.
- Umu Aiman. (2019). *Syari'at berpakaian yang baik dalam al - qur'an surah al- a'raf ayat 26 (studi tafsir ibnu katsir) skripsi*.
- Usiono., Maimun Aqsha Lubis Abdin Lubis., Jima'ain, M. T. A. @, Sjahrony, A., & Ikwan Lubis. (2020). Dinamika Pendidikan Islam: Pengaruh Peradaban Islam dan Ketamadunan Barat dalam Budaya dan Pendidikan di Malaysia. *ASEAN Comparative Education Research Journal on Islam and Civilization*, 3(2), 55–70.
- Wardah Nuronyah. (2019). Rethinking Hijab in Contemporary Indonesia: A Study of Hijab Community “Tuneeca Lover Community.” *Wawasan: Jurnal Ilmiah Agama Dan Sosial Budaya*, 4(2), 214–221.
- Wati Nafisatur Riyadloh. (2015). *Kritik interpretasi kelompok pemikir liberal terhadap ayat al-qur'an tentang jilbab berdasarkan tinjauan ulama dalam surah al-aḥzâb ayat 59 tesis*. Doctoral dissertation, Universitas Muhammadiyah Surakarta.
- Yuni Marsita. (2020). *Konsistensi Mahasiswa Berbusana Syar'i di dalam dan di Luar Kampus. Universitas Islam Negeri Ar-Raniry Darussalam – Banda Aceh*.

Haji Senik Seligi, 1818-1929: Sumbangannya Terhadap Pengajian Al-Quran Di Kelantan

Mohd Fadli Ghani
Perbadanan Muzium Negeri Kelantan
fadliayman@gmail.com

ABSTRAK

Haji Senik Seligi, 1818-1929 adalah seorang ulama besar Kelantan yang terkenal kerana keilmuannya dalam bidang pengajian al-Quran. Beliau adalah ulama Melayu pertama yang belajar di Universiti al-Azhar, Mesir dan pernah menjadi guru di Mekah selama lebih 10 tahun. Sekitar awal dekad 1880-an, beliau telah kembali ke Kelantan dan mengasaskan pusat pengajiannya yang biasa dikenali sebagai Pondok Seligi di Pasir Puteh, Kelantan. Di sini, beliau telah memajukan pendidikan al-Quran meliputi pelbagai aspek ilmu al-Quran termasuk tajwid, taranum, tafsir dan juga ulum al-Quran. Kemunculan pondoknya di Kelantan telah menjadi penyambung kepada perjuangan Tok Konok (m. 1893) dan Imam Haji Che Samat Kampung Laut (m. 1896) yang merupakan guru-guru al-Quran terkemuka di Kelantan, selain Tok Mesir (m. 1909) yang sezaman dengannya. Yang lebih penting lagi adalah kegiatan keilmuannya itu telah memberi sumbangan dalam mengangkat kedudukan Kelantan sebagai negeri Serambi Mekah ketika itu. Kajian ini bertujuan untuk meneliti biografi Haji Senik sebagai seorang tokoh ulama serta juga peranan dan sumbangannya dalam membangunkan pengajian al-Quran di Kelantan sebelum kelahiran generasi Tok Kenali (m. 1933).

PENDAHULUAN

Nama Haji Senik Seligi agak tersembunyi dalam menganalisis sejarah pergerakan ulama di Kelantan, walaupun beliau diketahui seorang yang sangat alim dalam ilmu al-Quran dan seorang qari yang terkemuka. Beberapa pengkaji seperti Ismail Che Daud mengatakan Haji Senik Seligi adalah di antara ulama terawal yang membuka pondok di Pasir Puteh, di mana Dr Abdul Rahman Abdullah menyenaraikan beliau sebagai ulama pondok di Pasir Puteh dalam kelompok Tahap II (1890-1920-an), selepas generasi Tuan Pengkalan Tangga dan Tok Merbol. Namun begitu, yang membuatkan nama Haji Senik Seligi menjadi terkenal adalah kebolehannya dalam ilmu qiraat dan taranum sehingga meletakkan beliau di barisan hadapan di kalangan ulama-ulama al-Quran di Kelantan.

Di antara tokoh al-Quran yang boleh dikatakan sebaris dan sezaman dengan beliau ialah:

- i. Tok Konok (m. 1893), nama sebenarnya Nik Zainal Abidin Nik Ismail, seorang ahli al-Quran yang bergiat di Jalan Merbau sezaman dengan Tuan Tabal.
- ii. Imam Haji Che Samat Kampung Laut (m. 1896), nama sebenarnya Che Samat Che Senik, lahir dalam sebuah keluarga qari dan guru al-Quran yang terkenal. Kebolehannya dikatakan setaraf dengan Tok Konok dan menjadi Imam Masjid Besar Kota Bharu.
- iii. Tok Mesir (m. 1909), nama sebenarnya Wan Mahmud Wan Ahmad, tokoh lepasan Mesir ini dikatakan memperkenalkan taranum berlahjah Arab di Kelantan dan bergiat di Surau Tok Mesir, Jalan Gajah Mati.
- iv. Tok Senggora (m. 1930), nama sebenarnya Abdullah Mohd Kassim, berasal dari Kampung Perik, tetapi ayahnya berasal dari Senggora. Masyhur kerana menguasai ilmu qiraat dan taranum serta sangat ahli dalam Qiraat Tujuh dan menulis beberapa kitab ilmu tajwid. Muridnya ramai dari Kelantan, tetapi bergiat dan mati di Mekah.

KELUARGA, KELAHIRAN DAN KONFLIK YANG BERLAKU

Latar belakang keluarga Haji Senik sangat menarik kerana beliau dikatakan lahir dalam sebuah keluarga yang berkerabat dekat dengan Raja Patani, tetapi dalam suasana perang ekoran penjajahan Siam ke atas negeri tersebut. Menurut dakwaan pihak terdekat dengan keluarganya, nama ayah beliau ialah Salleh bin Tok Doyan, tetapi lebih terkenal dengan gelaran Lebai Salleh kerana ayahnya seorang ahli agama walaupun berkerabat dekat dengan Raja Patani. Beberapa sumber memberitahu bahawa keluarga mereka terlibat dengan perang dan ramai yang terbunuh atau ditawan oleh Siam dengan dicucuk keting untuk dibawa ke Bangkok. Untuk tujuan keselamatan, keluarga mereka telah menukar nama dengan menggugurkan nama diraja dan menggunakan nama tubuh yang baru sebagai nama samaran. Dipercayai nama Salleh dan Doyan itu juga adalah nama samaran.

Berasaskan nama keluarga diraja Patani ketika itu, dipercayai nama ayah Haji Senik ialah Tuan Salleh atau Long Salleh, jika nama Salleh itu nama tubuhnya yang sebenar, sedangkan nama Haji Senik sendiri mengikut satu riwayat ialah Tuan Ahmad atau Tuan Mohammad. Ketika mereka berhijrah meninggalkan Patani, namanya ditukar kepada Senik bin Lebai Salleh bin Doyan. Tentang tahun kelahiran Haji Senik, tiada sebarang catatan yang jelas, tetapi berdasarkan peristiwa perang yang berlaku dan umur ketika Haji Senik meninggal dunia, beliau mungkin lahir sekitar akhir 1810-an iaitu selepas Tuan Sulong dilantik menjadi Raja Patani pada 1816. Sumber Kelantan (PPSK, 2013)⁷ memberitahu, Tuan Sulong Raja Patani itu adalah putera kepada Long Jenal,⁸ anakanda Long Yunus, Raja Kelantan. Sedangkan sumber Patani (Ibrahim Syukri, 2005: 81) mengatakan Tuan Sulong adalah dari keluarga anak cucu Dato' Pangkalan yang menjadi Raja Patani (1791-1808), tetapi Ahmad Fathy al-Fathani (1994: 61-62) mengatakan Tuan Sulong adalah cucunda Long Yunus.⁹

Pendapat yang mengatakan Haji Senik lahir dalam kerabat terdekat Raja Patani, percaya mereka adalah berketurunan dari keluarga Long Yunus dan Sultan Mansor Terengganu. Dari segi sejarah, Sultan Mansor adalah putera kepada Sultan Zainal Abidin Terengganu, iaitu putera kepada Bendahara Habib Tun Abdul Majid Johor. Ibu Sultan Mansor, Nang Ruqaiyah adalah puteri kepada Raja Mas Cayam dan Dato' Muda Abdul Kadir. Raja Mas Cayam adalah adik-beradik dengan Wan Anom (Long Sulaiman), ayah kepada Long Yunus. Dalam kata lain, Long Yunus dan Nang Ruqaiyah adalah sepupu. Namun begitu, pendapat yang bersumber dari Nakula (1980) ini ditolak oleh sumber-sumber Kerabat Diraja Lundang, sepertimana oleh Christopher Buyers juga. Manakala sumber Kelantan yang mengatakan Tuan Sulong adalah putera Long Jenal pula mungkin terpengaruh dengan dakwaan bahawa Tuan Sulong adalah anak saudara Sultan Mohammad I, memandangkan Long Jenal pernah dibuang negeri ke Menara (Bangnara) selepas pembunuhan Long Tan.

⁷ Lihat http://pp-sk.blogspot.com/2013/12/patani-kelantan-episod-7-tuan-besar_13.html?m=1

⁸ Christopher Buyers dalam Royal Ark menyatakan Long Jenal mempunyai enam orang anak, tetapi tiada anaknya yang bernama Tuan Sulong atau menjadi Raja Patani. Lihat www.royalark.net/Malaysia/kelant4.htm

⁹ Menurut Ahmad Fathy al-Fathani (1994), Tuan Sulong adalah putera kepada Che Ku Tuan Nawati binti Long Yunus dengan Tengku Mohammad bin Sultan Mansor Terengganu. Tengku Mohammad pernah menjadi Yang Dipertuan Kelantan (1795-1801), iaitu selepas kemangkatan Long Yunus. Ketika perang saudara pada 1801, Sultan Terengganu dikatakan pernah melantik anak saudaranya, Tuan Sulong menjadi Raja Kelantan bergelar Sultan Sulong, tetapi ia ditolak oleh putera-putera Long Yunus, lalu dijadikan Raja Muda Kelantan pada awal zaman Sultan Mohammad I (1801-1836). Setelah kemangkatan isterinya, Tengku Che Muda, Tuan Sulong telah melepaskan jawatan sebagai Raja Muda, lalu pergi mengembara sehingga baginda muncul di Patani pada 1807. Setelah Patani dipecahkan kepada tujuh wilayah pada 1816, Tengku Sulong dilantik sebagai Raja Patani menggantikan raja berbangsa Cina dari Chenak, Nai Phya. Ahmad Fathy al-Fathani memetik maklumat ini dari sumber Nakula (1908), Sejarah Kelantan: Beberapa Lintasan.

Pendapat yang lebih tepat dalam hal ini ialah pandangan Ibrahim Syukri (2005) walaupun beliau tidak dapat menjelaskan dengan tepat hubungan di antara Tuan Sulong dengan Datu Pengkalan (Long Jaafar Tuan Abdul Samad). Long Jaafar sebenarnya adalah menantu Sultan Mohammad II, Sultan Patani yang dibunuh oleh Siam pada November 1785, setelah baginda mengahwini Nang Benua. Nang Benua adalah puteri Sultan Mohammad II Patani dengan Che Ku Tuan Wook, puteri Long Yunus Kelantan. Long Jaafar dan Nang Benua mempunyai tiga orang putera, Tuan Sulong, Tengku Lamidin dan Tuan Kechik. Setelah Sultan Mohammad II Patani terbunuh dalam Perang Patani pada 1875, Siam telah melantik cucunya, Tengku Lamidin menjadi Sultan Patani pada 1876. Pada 1891, Tengku Lamidin telah memberontak, lalu dibunuh oleh Siam dan ayahnya Datu Pengkalan dilantik sebagai Sultan yang baru. Pada 1810, Datu Pengkalan telah memberontak terhadap Siam, lalu turut dibunuh oleh Siam.

Ekoran pembunuhan Datu Pengkalan Long Jaafar ini, Siam kemudiannya telah orang Cina sebagai Raja Patani, sebelum memecahkan Patani kepada tujuh wilayah pada 1816, dan melantik putera Long Jaafar, Tuan Sulong sebagai Sultan Patani yang baru, iaitu salah satu dari tujuh wilayah yang dipecahkan itu. Long Jaafar yang dilantik sebagai Datu Pengkalan (Raja Datu) adalah putera kepada Tuan Abdul Samad, Raja Datu Pengkalan.¹⁰ Ayah Tuan Abdul Samad ialah Raja Putrana yang berasal dari Besut telah dilantik sebagai Raja Selindung Bayu setelah menjadi menantu Raja Selindung Bayu. Raja Putrana adalah anak kepada Raja Kadhi, putera Raja Lingga di Kepulauan Riau yang dilantik sebagai Raja Besut oleh Sultan Johor-Riau pada abad ke-18.¹¹ Dipercayai Raja Lingga adalah berasal dari keturunan Sultan Johor-Riau yang menguasai seluruh wilayah tinggalan Kesultanan Melaka selepas serangan Portugis pada 1511.

Walaupun lahir dalam keluarga diraja, keluarga Tuan Sulong seperti mana tradisi Raja-raja Patani adalah berpendidikan agama dan berdamping rapat dengan para ulama. Ahmad Fathy al-Fathani sendiri menggambarkan dalam versinya bahawa Tuan Sulong pergi ke Patani untuk mendalami ilmu agama, dan jika Lebai Salleh itu adalah puteranya, maka wajar beliau juga seorang agamawan. Lebai Salleh mungkin lahir di Kota Perawan, tempat Datu Pangkalan berkuasa, tetapi Haji Senik mungkin lahir di Kota Gerisik pada 1818, iaitu dua tahun selepas Tuan Sulong diangkat sebagai Sultan Patani yang baru menggantikan raja Cina, Nai Phya. Pada 1829, telah berlaku krisis politik di antara Kedah dan Siam. Tengku Kudin telah memimpin tentera Kedah menghalau Gabenor Siam di negeri itu dan mengejar mereka hingga ke Singgora, menyebabkan Siam Singgora dan Ligor telah bergabung menentang Kedah pada 1931.

Terdesak dengan serangan Kedah itu, Raja Jambu, Nai Phya telah mengarahkan raja-raja enam wilayah Patani menghantar bantuan tentera untuk membantu Siam. Raja-raja Patani, Nongchik, Legeh dan Jalor telah mematuhi arahan ini, sedangkan Raja Reman dan Sai enggan tunduk kepada arahan Siam. Tentera empat wilayah tersebut berkumpul di Jambu untuk bergerak ke Singgora. Dalam perjalanan ke Singgora, empat Raja Melayu itu telah berpaling

¹⁰ Ada riwayat mengatakan ayah Long Jaafar ialah Engku Seri Maharaja Long Sulong, putera Raja Putrana. Raja Putrana adalah berasal dari keturunan Raja Lingga yang memerintah di Besut. Berkemungkinan Long Sulong adalah gelaran kepada Tuan Abdul Samad, tetapi yang lebih tepat Long Sulong adalah nama gelaran bagi Raja Jaafar atau Long Jaafar.

¹¹ Menurut Hikayat Patani versi A. Teeuw dan D.K Wyatt, dalam satu krisis politik di Patani, seorang pembesar Patani, Datuk Raja Khadi yang menjadi 'Wang' telah lari ke Besut. Beberapa ketika kemudian Datuk Raja Kadhi balik semula ke Patani dan dilantik sebagai Seri Paduka Tuan. Lihat Hikayat Patani the Story of Patani, hal. 138-139. Tetapi tidak dapat dipastikan apakah Datuk Raja Khadi ini orang yang sama dengan Raja Khadi, pemerintah Besut.

tadah dengan membantu Kedah menyerang Raja Jambu berbangsa Cina itu dan mara hingga ke Singgora, lalu bergabung dengan Kedah. Ketika Singgora sedang tersedak, tentera Siam dari Bangkok telah tiba dan tercetus perang besar di Bukit Anak Gajah. Dalam pertempuran ini, Tengku Kudin telah syahid dan pasukan Kedah-Patani telah tewas. Tentera Patani yang berundur balik telah dikejar oleh tentera Siam, lalu Tuan Sulong mendapatkan bantuan dari datuk saudaranya, Sultan Kelantan dan sepupunya, Sultan Terengganu.

Sultan Mohammad I Kelantan telah mengirinkan tentera dipimpin oleh Raja Muda Kampung Laut (Long Ismail), puteranya (Long Mohammad) dan Raja Banggol (Long Jenal). Sultan Mansor II Terengganu pula mengirinkan tentera diketuai oleh Panglima Tengku Idris, Wan Kamil dan Encik Ismail. Beberapa ulama besar seperti Sheikh Daud al-Fathani, Sheikh Abdul Samad al-Falembani, Sheikh Wan Mustafa (Tok Bendang Daya Tua), Sheikh Wan Mohammad (Tok Ketitir) dan lain-lain juga turut terlibat dalam perang ini. Pada akhirnya, Patani telah dapat dikalahkan setelah Siam membakar 'baloh padi' dan menyekat bantuan makanan dari luar. Tentera Kelantan dan Terengganu terpaksa berundur balik, sedangkan Tuan Sulong (Raja Patani) dan Tuan Kunder (Raja Jalor) terpaksa berundur ke Kelantan bersama pembesar dan keluarga mereka. Nik Dah (Raja Legeh) dan Tuan Kechik (Raja Nongchik) telah bersembunyi di Hulu Patani.

Semua mereka telah diburu oleh Siam, sehingga Tuan Kechik¹² dapat dibunuh, tetapi Nik Dah terlepas ke Perak. Siam telah merancang untuk menyerang Kelantan dan Terengganu kerana membantu Patani. Keadaan ini memaksa Sultan Mohammad I Kelantan menyerahkan Tuan Sulong dan Tuan Kunder kepada Siam, selain membayar ganti rugi sebanyak \$50,000.00 kepada Siam. Terengganu pula terpaksa menyerahkan beberapa orang panglima Patani yang berlindung di Terengganu seperti Panglima Damit, Panglima Mahmud, Panglima Pit dan Panglima Ahmad kepada Siam. Di Patani, Siam bukan sahaja membunuh, mencabul dan merosakan harta rakyat Patani, bahkan telah menawan lebih 4,000 orang rakyat Patani, lalu dicucuk keting dan digiring ke Bangkok sebagai tawanan perang dan hamba abdi. Di Kota Bharu, selain Tuan Sulong dan keluarganya, turut menjadi buruan ialah Dato' Lela Seri Paduka Raja Wan Ahmad, Perdana Menteri Patani yang berundur ke Kelantan bersama anaknya, Wan Hassan (Tok Kuda).

Dato' Wan Ahmad dan Wan Hassan akhirnya telah ditembak oleh Siam di Kota Bharu, yang menyebabkan seluruh putera istana, pembesar dan panglima perang dari Patani terpaksa menyamar dan menukar nama untuk mengelakkan mereka diburu oleh Siam. Di antara tokoh terkemuka yang terpaksa menukar nama ialah Nik Osman, putera Nik Dah (Raja Legeh) yang bersembunyi di Tumpat telah menukar namanya kepada Seman sahaja dan membalik nama anaknya. Anaknya, Nik Senik ditukar namanya menjadi Seman bin Senik,¹³ Nik Osman pula menjadi Senik bin Seman. Seorang lagi, panglima Patani, Wan Abdul Samad Jarum. Beliau adalah anak kepada Panglima Wan Jamaluddin. Selepas perang ini, anak-anaknya terpaksa meninggalkan Patani pergi ke Terengganu (Wan Jalal), Kelantan (Wan Abdul Samad), Kedah (Wan Idris)¹⁴ dan seorang lagi ke Bangkok. Ketika berada di Kelantan, Wan Abdul Samad

¹² Menurut Ibrahim Syukri, Tuan Kechik (Raja Nongchik) adalah adik kepada Tuan Sulong. Sumber lain mengatakan Tuan Kechik adalah anak saudara Tuan Sulong.

¹³ Pada satu masa yang lain, Seman bin Senik (anak) telah dihantar belajar di Mekah dan akhirnya menjadi Penasihat Agama Istana Kelantan. Tetapi kerana satu perselisihan, Seman bin Senik telah berhijrah ke Pahang dan menjadi ulama terkenal di sana. Haji Seman bin Senik (atau Othman bin Senik) lebih terkenal dengan gelar Tok Boto' telah dilantik sebagai Mufti Pahang yang pertama oleh Sultan Wan Ahmad.

¹⁴ Wan Idris Wan Jamal al-Jarum kemudian muncul sebagai seorang ulama besar di Kedah selepas pulang dari Mekah. Sheikh Wan Idris masyhur dengan panggilan Tok Sheikh Jarum, moyang kepada bekas Presiden PAS, Dato' Ustaz Fadzil Mohd Noor.

menukar namanya kepada Mahmud bin Che Seman, iaitu ayah kepada Qadhi Haji Nik Ismail dan datuk kepada Dato' Perdana Nik Mahmud yang terkenal itu.

Dalam konflik yang sangat meruncing inilah, terutama setelah Tuan Sulong ditawan oleh Siam dan hilang seluruh berita tentangnya, di mana baginda dipercayai dibunuh oleh Siam, keluarga terdekat telah berundur dari Kota Bharu ke Pasir Puteh dengan identiti yang baru. Ayah Haji Senik, Tuan Salleh dikenali sebagai Lebai Salleh bin Doyan,¹⁵ sedangkan Tuan Ahmad puteranya dinamakan sebagai Senik bin Lebai Salleh. Turut berhijrah ke Pasir Puteh ialah empat keluarga ulama lain, yang dipercayai juga berkerabat dengan Lebai Salleh. Menurut riwayat lisan, ketika tiba di Padang Pak Amat, Pasir Puteh, Haji Senik masih digelar 'Raja Budak' di kalangan mereka dan beliau diusung selayaknya putera-putera raja dari Kota Bharu ke Pasir Puteh. Berdasarkan gelaran, peristiwa perang dan tarikh kematiannya inilah, dianggarkan beliau berumur sekitar 15 tahun ketika berhijrah ke Kelantan. Beberapa maklumat lisan keluarganya mengatakan beliau meninggal dunia dalam usia sekitar 120 tahun pada 1929.

Panggilan gelaran "Raja Budak" yang digunakan terhadap Haji Senik ketika tiba di Pasir Puteh telah membentuk persangkaan yang kuat kepada kajian ini bahawa Haji Senik sebenarnya adalah cucunda kepada Tuan Sulong bin Long Jaafar, Raja Patani. Panggilan Raja Budak bermaksud, bakal raja yang masih muda. Sudah tentu gelaran tidak digunakan secara bebas oleh orang awam, melainkan jika seseorang itu benar-benar putera raja dan merupakan bakal pewaris takhta. Atas asas ini juga, adalah sangat munasabah jika dikatakan Lebai Salleh itu adalah putera sulung kepada Tuan Sulong, Raja Patani dan Haji Senik bin Lebai Salleh adalah cucunda baginda. Riwayat-riwayat lisan di Kampung Seligi yang mengatakan bahawa Haji Senik adalah 'kerabat dekat' Raja Patani adalah bertepatan dengan hipotesis ini dan jika dicantumkan dengan gelaran 'Raja Budak', maka ia akan menunjukkan dengan tidak ragu-ragu lagi bahawa Lebai Salleh adalah putera Tuan Sulong.

Ibu kepada Haji Senik hanya dikenali sebagai Mek Senik sahaja, tetapi dipercayai juga kerabat diraja Patani. Beliau turut menyembunyikan identiti dengan hanya dikenali sebagai Mek Senik yang memberi maksud, ibu kepada Senik dalam pertuturan orang Kelantan dan Patani. Haji Senik juga dikatakan berkeluarga dengan Tuan Guru Haji Samat Jakar yang juga berasal dari Patani. Sumber keluarganya memberitahu, seorang bekas Qadhi Krabi, Thailand adalah termasuk anak saudara Haji Senik, iaitu anak kepada abangnya, Haji Omar. Ketika berada di Mekah, Haji Senik telah berbiras dengan seorang ulama Patani yang terkenal, Haji Salleh Patani. Menurut Ismail Che Daud (2007), Haji Senik adalah ulama sezaman dengan Haji Wak Yib Padang Mo'kan, Tuan Guru Haji Daud Khatib dan Tuan Guru Haji Senik Lambor. Abdul Rahman Abdullah (1997) menyenaraikan Haji Senik Seligi sebagai ulama Kelantan pada generasi 1890-1920. Pendek kata, Haji Senik bukan sahaja kerabat diraja, tetapi lahir dalam kalangan alim-ulama.

HIJRAH KE KELANTAN

Kekalahan perang pada April 1832 telah memaksa Tuan Sulong sebagai Raja Patani mendapatkan perlindungan di Kelantan yang diperintah oleh datuk saudaranya, Sultan Mohammad I. Mereka sekeluarga telah tiba di Kota Bharu pada pertengahan 1832, tetapi malangnya kerana Tuan Sulong sebagai Raja Patani dan Dato' Wan Ahmad sebagai Perdana Menteri Patani telah dikejar oleh Siam. Tekanan Siam ke atas Sultan Kelantan telah memaksa

¹⁵ Nama Doyan digunakan untuk menutup nama Tuan Sulong adalah sangat munasabah, kerana nama Doyan itu adalah nama orang kampung atau orang darat, yang biasanya tidak digunakan dalam keluarga diraja di Kelantan.

baginda menyerahkan Tuan Sulong dan Tuan Kundur (Raja Jala) kepada Siam, sedangkan Dato' Wan Ahmad dan anaknya, Wan Hassan yang enggan menyerah diri telah diburu oleh Siam dan akhirnya ditembak di Kota Bharu. Keadaan ini memberikan tekanan kepada keluarga Tuan Sulong, lalu Tuan Salleh telah merancang untuk berpindah keluar dari Kota Bharu, menuju ke Pasir Puteh. Mereka meninggalkan Kota Bharu dalam tahun tersebut juga, dan membina penempatan di kawasan Padang Pak Amat.

Menurut satu maklumat lisan dalam kajian tentang Haji Ishak Patani di Batu Sebutir, Padang Pak Amat, ulama hafiz ini dikatakan datang ke Padang Pak Amat bersama empat atau lima keluarga yang lain. Maklumat keluarga Haji Senik memberitahu, kebanyakan mereka adalah dari kerabat diraja Patani atau pembesar dan ulama. Berdasarkan maklumat-maklumat tersebut, empat keluarga ulama dikenal pasti berhijrah ke Padang Pak Amat dalam tahun 1832 itu, iaitu:

- i. Lebai Salleh bin Doyan, dipercayai putera kepada Raja Patani, Tuan Sulong bin Long Jaafar. Anaknya, Haji Senik adalah tokoh dalam tulisan ini. Lebai Salleh telah membina penempatan keluarganya di Padang Pak Amat, atau lebih tepatnya di Kampung Wakaf. Beliau mungkin meninggal dunia dan dikebumikan di Kampung Wakaf. Dalam satu riwayat lisan yang lain mengatakan Siam turut menawan Lebai Salleh bersama ayahandanya di Kota Bharu dan diseret dengan gajah ke Bangkok. Jika maklumat kedua ini benar, ertinya Lebai Salleh tidak menyertai Haji Senik ke Kampung Seligi.
- ii. Imam Haji Hassan, tiada maklumat lanjut tentang asal-usulnya, tetapi dikatakan oleh sesetengah sumber bahawa keturunannya juga berdarah raja. Membuka penempatan di Kampung Seligi dan dilantik menjadi Imam Mukim Seligi. Menantunya, Imam Haji Abdullah dari Alor Bakat, Melor yang menggantikan beliau sebagai Imam Mukim Seligi, kemudian berbesan dengan Haji Senik, apabila putera Haji Senik, Imam Haji Che Mamat menikahi cucu Imam Haji Hassan, Setajar Haji Abdullah.
- iii. Tok Chor, tidak diketahui tentang asal-usulnya, tetapi dipercayai bernama Mansor atau Tuan Mansor dan berketurunan raja berdasarkan gelaran 'Nik' yang digunakan oleh anaknya, Nik Limah. Seorang tokoh agama di Patani, kemudian membuka penempatan di Kampung Seligi juga sehingga kawasan sawah di situ dipanggil Baruh Tok Chor. Beliau naik ke Mekah bersama anak-anaknya sekitar 1870-an untuk menyambung belajar, kemudian menikahkan seorang anaknya, Hajah Mek Teh dengan Haji Salleh Patani di Mekah, dan seorang lagi, Hajah Nik Limah dinikahkan dengan Haji Senik, anak Lebai Salleh.
- iv. Haji Ishak al-Hafiz, seorang ulama yang hafaz al-Quran. Telah berhijrah ke Padang Pak Amat dan membuka penempatan di Kampung Batu Sebutir. Tidak ada maklumat lanjut tentang asal-usul dan keturunannya.

BELAJAR AGAMA DI MEKAH

Setelah keadaan kehidupan Lebai Salleh mulai tenang dan stabil, beliau mulai mengatur pendidikan anaknya, Haji Senik. Dipercayai pada peringkat ini, Haji Senik belajar dengan ayahnya sendiri di Padang Pak Amat, selain mungkin turut belajar juga dengan Imam Haji Hassan, Tok Chor dan Haji Ishak al-Hafiz. Ada juga kemungkinan Haji Senik turut belajar dengan dua ulama besar Patani yang telah berhijrah ke Pasir Puteh ketika itu, iaitu Tok Merbol di Kampung Saring dan Tuan Pangkalan Tangga di Kampung Lembah, Semerak. Andaian yang mengatakan beliau belajar dengan Tok Merbol adalah berdasarkan hubungan rapat beliau dengan cucu Tok Merbol, Haji Wan Mohammad Wan Hussein (Haji Mat Perak) di Mekah. Setakat ini belum ada sebarang maklumat tepat tentang pengajian yang dilaluinya di

Kelantan,¹⁶ tetapi beliau telah naik ke Mekah untuk belajar agama sekitar tahun 1840, iaitu pada usia yang sudah mencecah sekitar awal 20-an. Ahli-ahli keluarganya memberitahu, beliau belajar dan tinggal di Mekah selama 40 tahun, dan dipercayai telah balik ke Kelantan selepas peristiwa “Angin Besar Kelantan” yang berlaku pada 1880.

Berada di Mekah telah membolehkan Haji Senik mendalami ilmu agama dengan lebih serius, terutama ilmu qiraat dan taranum yang menjadi minat utamanya, selain ilmu bahasa Arab, fekah, usuludin dan tasawuf. Terdapat sumber-sumber yang mengatakan beliau belajar di sana di antara 20 hingga 25 tahun, tetapi sumber keluarga terdekatnya mengatakan beliau berada di Mekah selama 40 tahun.¹⁷ Tetapi yang paling jelas, selepas meninggalkan Kelantan, beliau belajar di Mekah beberapa belas tahun, kemudian naik ke Mesir untuk belajar lagi beberapa tahun, sebelum kembali belajar semula di Mekah. Setelah itu, beliau terus bermukim di Mekah sambil mengajar sehingga menjadikan keseluruhan tempoh tersebut 40 tahun. Ada sumber lisan yang mengatakan beliau berada di Mesir selama enam tahun, iaitu setelah hampir 20 tahun menadah di Mekah. Secara kronologi, beliau belajar di Mekah 19 tahun, diikuti belajar di Mesir enam tahun, kemudian 15 tahun lagi belajar dan mengajar di Mekah, menjadikan keseluruhannya 40 tahun.

Dakwaan ahli keluarganya yang mengatakan Haji Senik belajar dan tinggal di Mekah selama 40 tahun ada kewajarannya. Ini berdasarkan tahun beliau bertolak ke Mekah adalah sekitar awal 1840-an ketika usianya di awal 20-an. Bahkan, ada maklumat keluarganya yang memberitahu, ketika Haji Senik naik ke Mekah, usianya masih belasan dan belum cukup umur untuk berkahwin. Beliau kembali ke Kelantan selepas peristiwa ‘Angin Besar’ yang berlaku pada 1880, mungkin sebelum 1885, ketika Sultan Mohammad II (1837-1886) masih memerintah. Walau bagaimanapun, tidak diketahui secara jelas siapakah guru-guru di Mekah dan Mesir kecuali dua ulama qiraat yang terkenal di Mekah, Sheikh Saruji dan Sheikh Mohammad Adham adalah guru-guru al-Qurannya. Di antara guru-guru al-Quran yang terkemuka di Mekah pada zaman tersebut termasuklah Sheikh Hassan Badir al-Muqri, Sheikh Muhammad ad-Dairi at-Tahaami, Sheikh Ahmad Ridah Salmunah, Sheikh Sulaiman al-Barbari dan Sheikh Ibrahim Saad al-Masri. Guru-guru ini ditadahi oleh ulama-ulama qiraat terkemuka seperti Tok Konok (m. 1893) dan Tok Senggora (m. 1930) yang hidup sezaman dengan Haji Senik di Mekah.

Ketika berada di Mekah, secara relatifnya Haji Senik berpeluang bertemu dan belajar dengan Sheikh Daud al-Fathani (m. 1846), Tok Pulai Chondong (m. 1873) dan Sheikh Wan Ali Wan Ishak sebagai ulama-ulama Melayu yang terkemuka di Mekah. Di samping itu juga, beberapa ulama besar yang sebaya dengan Haji Senik juga turut aktif di Mekah sama ada sebagai guru atau pelajar seperti Sheikh Wan Mohammad Zain al-Fathani (m. 1908), Tok Ali Kutun (m. 1913), Tuan Padang (m. 1895), Tuan Jamal Peringat (m. 1886), Tuan Guru Yaakob Tok Chekeli (m. 1907), Sheikh Nik Dir (m. 1898), Tuan Minal (m. 1913), Sheikh Abdul Qadir Bukit Bayar (m. 1864), Tok Sheikh Duyung (m. 1889) dan Tok Bendang Daya (m. 1895). Di kalangan junior Haji Senik pula termasuklah Tuan Guru Haji Arshad Tok Pulai Chondong (m. 1912), Tok Konok (m. 1893), Tuan Tabal (m. 1896), Sheikh Nik Mat Kechik (m. 1915), Sheikh Wan Ahmad al-Fathani (m. 1908), Sheikh Wan Mat Perak (m. 1916) dan lain-lain. Sepanjang

¹⁶ Haji Senik juga dicatatkan turut menguasai ilmu pendekar – silat – yang dipercayai dipelajari di Kelantan ketika remaja, sebelum naik ke Mekah.

¹⁷ Pendapat yang mengatakan beliau belajar di Mekah selama 20-25 tahun dengan pendapat tinggal di Mekah selama 40 tahun adalah tidak bertentangan, kerana Haji Senik telah menghabiskan 25 tahun pertama untuk belajar dan tinggal di Mekah 15 tahun lagi untuk mengajar.

40 tahun di Mekah ini, Haji Senik sempat bergaul dengan mereka sama ada sebagai guru, pelajar atau sahabat.

Ketika Haji Senik balik ke Kelantan pada awal 1880-an, ulama-ulama juniornya di Mekah seperti Tok Konok (m. 1893), Tuan Tabal (m. 1896), Qadhi Haji Nik Ismail (m. 1898), Haji Awang Alim (m. 1890-an), Imam Haji Che Samat Kampung Laut (m. 1896), Haji Abbas Sungai Budor (m. 1890-an), Haji Nik Wan Daud (m. 1907) dan Imam Haji Abdullah Jalaluddin (m. 1906) sedang mencipta nama di Kota Bharu. Bagi generasi ulama Kelantan awal abad ke-20 seperti Tok Kenali (m. 1933), Tok Padang Jelapang (m. 1935), Haji Abdul Malik Sungai Pinang (m. 1934), Tok Selehong (m. 1935), Tok Kemuning (m. 1934), Haji Wan Daud Khatib (m. 1936), Mufti Haji Wan Musa (m. 1939), Mufti Haji Wan Mohammad (m. 1920), Dato' Perdana (m. 1967) dan lain-lain, walaupun mereka sempat hidup sezaman dengan Haji Senik, generasi ini boleh dikatakan berpangkat cucu dengannya. Kerana itu, Haji Senik tidak sempat bersama mereka di Mekah, tetapi bersahabat atau hidup sezaman di Kelantan. Dipercayai ramai di kalangan ulama generasi Tok Kenali telah menjadikan Haji Senik sebagai rujukan memandang beliau adalah guru kepada guru-guru ulama generasi Tok Kenali.

Di antara kejayaan terbesar Haji Senik ketika belajar di Mekah ialah beliau dapat menghafal al-Quran sebelum pergi ke Mesir. Dalam tradisi pengajian al-Quran di kalangan para qurra', mereka biasa menghafal al-Quran selain menguasai ilmu tahwid, qiraat dan taranum. Berdasarkan maklumat keluarganya, Haji Senik dikatakan "ingat di mulut" al-Quran yang dibacanya, yang memberikan pengertian bahawa beliau seorang penghafal al-Quran. Keadaan ini diperkukuhkan oleh sistem pengajian di Universiti al-Azhar yang menghendaki pelajarinya menghafal al-Quran dan menguasai bahasa Arab. Di kalangan ulama Melayu dewasa itu, sebahagian mereka menghafal al-Quran seperti Tok Mesir (Wan Mahmud Ahmad), Haji Ahmad Hafiz, Haji Mat Saman Jawi dan lain-lain walaupun tradisi menghafal al-Quran belum menjadi budaya. Dalam satu riwayat lisan, diceritakan pada satu tahun, ketika penggali kubur menggali kawasan sebelah kuburnya kerana mengebumikan salah seorang anak mereka, telah mendapati jenazah Haji Senik masih utuh walau sudah meninggal dunia puluhan tahun. Ini menguatkan hujah yang mengatakan beliau menghafal al-Quran.

Ada sumber lain yang mengatakan Haji Senik telah turut mendalami ilmu tasawuf secara serius di Mekah sehingga beliau 'hilang selera' terhadap dunia. Beliau dikatakan mempelajari kitab-kitab tasawuf Imam al-Ghazali (m. 1111), selain turut mengambil ijazah-ijazah tarekat daripada ulama yang masyhur di Mekah ketika itu. Berdasarkan pengamalan zikir-zikirnya, dipercayai beliau beramal dengan Tarekat Naqsyabandiah aliran Ahmadiyah. Pada zamannya, seorang ulama besar Tarekat Ahmadiyah, Sheikh Ibrahim bin al-Qadhi Salleh ar-Rashid (m. 1874) dari Sudan, iaitu murid kepada pengasas Tarekat Ahmadiyah, Sidi Ahmad bin Idris (m. 1837) mengajar di Mekah. Seorang lagi tokoh yang dipercayai guru tarekatnya ialah Sheikh Ahmad ad-Dandarawi (m. 1909).¹⁸ Dipercayai Haji Senik bersama-sama Tuan Tabal dan Haji Said Linggi belajar dan mengambil ijazah tarekat daripadanya. Ada anak-cucunya memberitahu bahawa beliau belajar tasawuf di Patani, tetapi maklumat ini boleh dipertikaikan kerana beliau tidak pernah belajar di Patani. Mungkin lebih tepat jika dikatakan beliau mengambil ijazah dan sanad tasawuf atau tarekat dari ulama Patani di Mekah atau belajar tasawuf bersama-sama ulama Patani seperti Sheikh Wan Ahmad al-Fathani.

¹⁸ Berdasarkan catatan Wan Mohd Saghir Abdullah (2005), Sheikh Wan Ahmad al-Fathani, junior Haji Senik di Mekah juga dikatakan belajar Tarekat Ahmadiyah dengan Sheikh Ibrahim Salleh ar-Rashidi, tetapi setelah sheikh tersebut wafat pada 1874, Sheikh Ahmad ad-Dandarawi menjadi pembimbing tasawufnya. Sheikh ad-Dandarawi juga adalah guru kepada Sheikh Haji Said Linggi.

ANAK MELAYU PERTAMA BELAJAR DI MESIR

Di Mesir, Haji Senik belajar di Universiti al-Azhar (Masjid Jamik al-Azhar) yang ketika ini pembelajarannya masih berbentuk halaqat atau ruwak. Pada era itu, Universiti al-Azhar dipimpin oleh Sheikh Muhammad al-Hifnawi (1758-1767) dan Sheikh Abdul Rauf as-Sajini (1767-1769) sebagai Sheikhul Azhar. Berdasarkan tahun pengajiannya di Mesir enam tahun di antara tahun 1860 hingga 1869, Haji Senik dapat dipastikan sebagai orang Asia Tenggara pertama yang belajar di Universiti al-Azhar.¹⁹ Setelah kembali dari Mesir, Haji Senik mulai mengajar ilmu al-Quran di Mekah, tetapi tidak dicatatkan mengajar kitab-kitab seperti kebanyakan ulama lain. Beliau dikatakan menguasai hampir keseluruhan qiraat yang diakui dalam ilmu al-Quran, selain turut berkeupayaan sebagai qari kerana turut menguasai ilmu taranum. Dipercayai beliau juga alim dalam ilmu fekah, tawasuf dan usuluddin, tetapi keilmuannya tidak menonjol kerana lebih memberi tumpuan kepada ilmu qiraat, baik di Mekah mahupun di Kelantan. Dalam dekad 1870-an, Haji Senik sebagai seorang ilmuan telah diambil sebagai menantu oleh salah seorang sahabat ayahnya, Tok Chor yang juga berada di Mekah ketika itu.

Haji Senik telah mengambil keputusan untuk membawa pulang keluarganya – isteri dan dua anaknya – ke Kelantan setelah 40 tahun bermukim di Mekah. Antara yang mendorong beliau balik ke Kelantan ialah kerana diajak oleh muridnya yang telah menjadi sahabatnya di Mekah, iaitu Haji Wan Mohammad Wan Hussein (Haji Wan Mat Perak), juga berasal dari Pasir Puteh. Tokoh ini juga merupakan pelarian politik Patani seperti Haji Senik. Haji Wan Mat Perak adalah cucu Tok Merbol, seorang ulama dikatakan berasal dari keturunan ulama dan pembesar Patani, Tok Ketitir, tetapi telah membuka pondok di Kampung Saring, Pasir Puteh. Tidak seperti Haji Senik, Haji Wan Mat tidak lama tinggal di Kelantan kerana telah berhijrah ke Kuala Kangsar, Perak sekitar 1886 dan menjadi guru agama di sana, termasuk menjadi guru kepada beberapa orang Sultan Perak. Sultan Idris Mursyidul A'zam Perak (1887-1916) kemudiannya melantik Haji Wan Mat Perak sebagai Mufti Perak atau Sheikhul Islam Perak pada awal pemerintahannya.²⁰ Haji Wan Mat Perak ini disebut-sebut balik ke Kelantan bersama Haji Senik pada awal 1880-an.

¹⁹ Wan Mohd Saghir Abdullah (2005), Syeikh Ahmad al-Fathani: Pemikir Agung Melayu dan Islam, Jld. 1, Kuala Lumpur, Khazanah Fathaniyah, hal. 44 mengatakan Sheikh Wan Ahmad al-Fathani (1856-1908) adalah orang dari Asia Tenggara yang pertama belajar di Universiti al-Azhar, tetapi beliau mengatakan Sheikh Wan Ahmad al-Fathani belajar di Mesir sekitar 1870-an, tetapi tidak dapat menyatakan tepat bilakah tahun sebenar beliau belajar di sana. Tetapi berdasarkan tahun kelahiran, pada 1876, beliau baru berusia 20 tahun. Wan Mohd Saghir (2005: 41-43) memberitahu, ketika umurnya susah melebihi 12 tahun (<1868) pergi ke Baitul Maqdis belajar ilmu perubatan. Setelah itu, beliau kembali ke Mekah, sebelum naik ke Mesir pada awal 1870-an. Berdasarkan sebuah puisi Sheikh Wan Ahmad al-Fathani yang diterjemahkan Sheikh Ahmad Fahmi Zamzam (1994), Sheikh Wan Ahmad memberitahu puisi tersebut ditulis di dalam Masjid Jamik al-Azhar pada 1292H (1876) setelah beberapa tahun belajar di sana. Boleh disimpulkan bahawa Sheikh Ahmad al-Fathani belajar di Universiti al-Azhar pada dekad 1870-an, terkemudian daripada Haji Senik.

²⁰ Perlantikan Wan Haji Wan Mat Perak sebagai Mufti Perak oleh Sultan Idris Mursyidul A'zam sekitar 1887, iaitu sebaik sahaja baginda menjadi Sultan Perak. Sebelum ini, jawatan Mufti Perak disandang oleh keturunan Daeng Selili yang berasal dari Tanah Luwuk, Sulawesi dengan jawatan Dato' Maharajalela. Selepas Perjanjian Pangkor pada 1874, British telah melantik J.W.W Birch sebagai Residen British di Perak. Pada 2 Novemver 1875, J.W.W Birch telah dibunuh oleh sekumpulan pembesar Melayu diketuai oleh Dato' Maharajalela. Dato' Maharajalela ketika ini ialah Pandak Lam. Selepas pembunuhan ini, Dato' Maharajalela Pandak Lam telah diburu oleh British dan akhirnya ditangkap dan dijatuhkan hukuman gantung pada 20 Januari 1877. Setelah 10 tahun jawatan mufti ini kosong, ia diisi semula oleh Haji Wan Mat Perak tanpa membawa gelaran Dato' Maharajalela kerana beliau bukan dari keturunan Daeng Selili. Ada pendapat yang mengatakan jawatan beliau ialah Sheikhul Islam Perak. Sama ada jawatan sheikhul Islam atau mufti, kedua-duanya adalah melanjutkan fungsi Dato' Maharajalela dalam menasihati Sultan Perak berkait urusan agama dan hukum-hakam. Yang jelas, jawatan yang digunakan selepas kematian Haji Wan Mat Perak pada 1929 ialah Mufti Perak.

KEMBALI KE KELANTAN

Kepulangan Haji Senik ke Kelantan berlaku sekitar awal 1880-an, mungkin 1882 atau 1883. Ketika beliau pulang ini, usianya sudah mencecah 60 tahun dan telah mempunyai dua orang anak hasil perkahwinan beliau dengan Nik Limah Tok Chor. Setelah tiba di Kelantan, beliau tinggal beberapa ketika di Kampung Batu Sebutir, di bekas rumah lamanya, tetapi kemudiannya merancang untuk membuka surau dan mengajar al-Quran. Beliau memilih untuk membuka surau di kampung isterinya, iaitu di Kampung Seligi. Imam Mukim Seligi ketika ini ialah Haji Abdullah dari Alor Bakat, Melor, iaitu menantu Imam Haji Hassan. Haji Senik telah membuka surau di tapak tanah milik isterinya, iaitu tanah asal Tok Chor di belah matahari naik (timur) Kampung Seligi, mengadap Baruh Tok Chor. Sejak berdirinya Surau Haji Senik di Kampung Seligi, para pelajar mulai mengunjungi beliau untuk mendalami ilmu al-Quran kerana nama Haji Senik sudah terkenal sebagai guru al-Quran di Mekah. Lama-kelamaan surau tersebut telah bertukar menjadi Pondok Seligi.

Kemasyhuran nama Haji Senik begitu cepat berkembang di Kelantan kerana tokoh-tokoh ulama di Kota Bharu seperti Qadhi Haji Nik Ismail Atas Banggol, Tok Konok, Tuan Tabal, Haji Mohd Said Khatib, Imam Haji Che Samat Kampung Laut, Mufti Haji Nik Wan Daud, Haji Awang Alim, Haji Abbas Sungai Budor dan lain-lain adalah termasuk di kalangan juniornya di Mekah, dan mungkin pernah belajar al-Quran dengannya di sana. Keadaan ini meletakkan Haji Senik pada kedudukan yang lebih tinggi berbanding ulama-ulama terkenal di Kota Bharu. Beberapa ulama yang menjadi penasihat dan guru agama di Istana Kelantan seperti Haji Wan Sulaiman Langgar, Tuan Jamal Peringat, Hakim Syed Mohammad al-Yahya, Tuan Padang, Tok Boto', Mufti Haji Wan Abdul Rahman Muda dan Imam Haji Abdullah Jalaluddin boleh dikatakan sebaya atau lebih muda dari beliau dan sangat mengetahui tentang keilmuannya sebagai bekas guru di Mekah. Kemudian, sekitar 1884, Kelantan telah dikejutkan dengan kematian Mufti Haji Wan Abdul Rahman Muda yang menjadi mufti sejak 1842.

Sebelum itu, Sultan Mohammad II telah berselisih pendapat dengan Tok Boto', salah seorang penasihat agama baginda yang menyebabkan Tok Boto' membawa diri ke Pahang dan dilantik sebagai Mufti Pahang pada zaman Sultan Wan Ahmad (1881-1908). Sultan Mohammad II yang telah mendengar kemasyhuran Haji Senik Seligi yang sedang meningkat naik di Kelantan itu, menyedari cicit sepupunya itu berkelayakan untuk mengisi kekosongan jawatan Mufti Kelantan. Haji Senik segera ditawarkan oleh Sultan Kelantan untuk menggantikan Haji Wan Abdul Rahman Muda sebagai mufti, tetapi beliau menolaknya di atas alasan bimbang sekiranya Sultan Kelantan tidak dapat melaksanakan syariat Allah sepenuhnya. Haji Senik lebih suka untuk terus berkhidmat sebagai guru di suraunya berbanding memegang jawatan yang besar di dalam kerajaan. Di atas sebab itu juga, Sultan Mohammad II telah memutuskan untuk menawarkan jawatan tersebut kepada Haji Nik Wan Daud Wan Sulaiman yang juga Imam Tua Masjid Besar Kota Bharu.

Setelah menolak jawatan sebagai Mufti Kelantan, Haji Senik meneruskan aktivitinya sebagai guru al-Quran di Kampung Seligi sehingga namanya masyhur sebagai Haji Senik Seligi. Suraunya di Seligi telah dikunjung oleh ramai pelajar, terutama setelah kematian guru-guru al-Quran terkemuka di Kelantan seperti Tok Konok pada 1893, Imam Haji Che Samat Kampung Laut pada 1896 dan Tok Mesir (Haji Wan Mahmud Ahmad) pada 1909. Hasil usaha gigih Haji Senik ini, lahir pula generasi baru ahli-ahli al-Quran di kalangan murid-muridnya seperti Haji Awang Puteh Permatang Gading, Haji Derahman Mat Diah Seligi, Khatib Haji Ismail Permatang Sungkai, Tok Ayah Him Mat Salleh Kampung Wakaf dan lain-lain yang terkenal kerana fasih dalam berbagai-bagai qiraat. Kebanyakan murid-murid Haji Senik

datang dari Perak dan Terengganu, selain pelajar tempatan. Salah seorang anak Haji Senik, Haji Che Mamat dilantik sebagai Imam Mukim Seligi menggantikan mertuanya, Imam Haji Abdullah kerana keelokkan bacaan al-Qurannya. Seorang lagi anaknya, Haji Abdul Aziz Kampung Panggung juga dikatakan berkebolehan dalam bacaan al-Quran.

Selain mengajar al-Quran, Haji Senik turut mempunyai satu keistimewaan iaitu beliau sangat beramal dengan amalan tasawuf atau tarekat. Beliau beramal dengan Tarekat Naqsyabandi Ahmadiyah seperti mana Tuan Tabal, Haji Said Linggi dan Sheikh Wan Ahmad al-Fathani. Salah satu amalan penting beliau ialah bersuluk seperti mana amalan Tok Selehong dan beliau mempunyai bilik sulit yang khas untuk tujuan bersuluk ini. Ahli-ahli keluarganya memberitahu bahawa Haji Senik sangat menjaga hatinya supaya tidak cenderung kepada dunia, bahkan setiap kali hatinya tertarik dengan dunia, beliau akan segera bersuluk untuk memastikan hatinya dapat dibersihkan daripada sifat cintakan dunia. Dipercayai juga, antara sebab Haji Senik menolak tawaran Sultan Mohammad II untuk menjadi mufti adalah kerana bimbang jika hatinya cenderung kepada kemasyhuran dunia. Bagi seorang pengamal tawasuf yang serius, mereka berusaha untuk menolak sebarang bentuk keseronokan dunia daripada mengganggu hatinya yang sentiasa mengingati Allah. Dakwaan yang mengatakan kebimbangan Haji Senik jika Sultan Kelantan tidak dapat melaksanakan syariat menyebabkan beliau menolak tawaran tersebut, mungkin hanya alasan kepada sultan supaya beliau dapat berlepas diri dari gangguan dunia.

Haji Senik sebenarnya lebih selesa hidup sederhana dan terus menjadi khadam kepada agama dengan mengajar al-Quran dan ilmu-ilmu agama di suraunya. Kesungguhannya beliau mengajar agama tanpa mempedulikan kelebihan dunia ini telah menyebabkan pelajar semakin bertambah ramai termasuk dari luar Kelantan. Akhirnya kampus perpondokan terawal terbentuk di Seligi dan ada pengkaji yang mengatakan bahawa Haji Senik adalah di antara ulama terawal yang membuka pondok di Jajahan Pasir Puteh pada dua dekad terakhir abad ke-19. Abdul Rahman Abdullah (1997) turut mendakwa bahawa Pondok Haji Senik Seligi masih aktif sehingga menjelang 1920. Di samping juga, Haji Senik dicatatkan telah mengambil pendekatan untuk mengajar agama dari kampung ke kampung di sekitar Padang Pak Amat hingga ke Selising bagi mengembangkan dakwah Islam, selain mengajar di suraunya di Kampung Seligi. Beliau dikatakan mengajar hingga ke Berangan, Alor Hijau, Bukit Merbau dan lain-lain di Selising, selain Kampung Wakaf, Gong Serai, Panggung, Permatang Sungkai, Sungai Kelong, Kubang Sawa dan lain-lain kampung di sekitar Padang Pak Amat.

Haji Senik dikatakan telah berhenti mengajar pada sekitar Musuh Tok Janggut (1915) kerana beliau terlalu uzur akibat usianya yang sudah sangat lanjut. Masalah pancaendera dan keupayaan fizikalnya telah menghalang beliau untuk terus berdakwah. Menurut seorang cucunya, ketika berlaku banjir besar, Bah Air Merah di Kelantan pada 1926, Haji Senik sudah tidak mengajar al-Quran, mungkin kerana faktor pendengarannya yang sudah merosot dengan teruk. Namun begitu, namanya telah masyhur sebagai guru al-Quran yang hebat setaraf dengan Tok Konok dan Tok Mesir di Kota Bharu. Disebabkan oleh keadaan yang memaksa itu, Haji Senik tidak lagi mengajar di Surau Haji Senik Seligi dan sejak 1920-an itu kemasyhuran namanya mulai pudar, terutama apabila muncul angkatan baru ulama-ulama Kelantan pada generasi Tok Kenali seperti Tok Kemuning, Tok Padang Jelapang, Tok Selehor, Tok Bachok dan lain-lain, termasuk Dato' Perdana Nik Mahmud dan Dato' Laksamana Mohammad Mohd Said yang merupakan penggerak utama institusi pondok di Kelantan pada awal abad ke-20.

KELUARGA HAJI SENIK

Haji Senik disebutkan naik ke Mekah ketika usianya masih muda iaitu masih belasan tahun atau awal 20-an dan belum berkahwin. Ketika berada di Mekah, beliau menyibukkan dirinya untuk belajar dan tiada sebarang catatan mengatakan beliau berkahwin di sana ketika belajar. Beberapa maklumat memberitahu bahawa Haji Senik tidak mahu berkahwin dengan gadis-gadis Arab kerana 'tidak tahan' dengan 'mulut' perempuan Arab dan beliau juga mungkin kerana sangat berhati-hati di atas faktor keselamatan, turut tidak mengahwini gadis-gadis Melayu keturunan Patani di Mekah. Setelah pulang dari Mesir ketika sudah berumur lebih 50 tahun, kawan ayahnya di Padang Pak Amat, Tok Chor telah naik ke Mekah untuk mengerjakan haji dan menyambung belajar bersama dua anaknya, Nik Limah dan Mek Teh. Setelah mendapati Haji Senik belum berkahwin, walaupun usianya sudah mencecah pertengahan umur, Tok Chor telah mencadangkan supaya Haji Senik dijodohkan dengan anaknya.

Bersetuju dengan cadangan Tok Chor ini, Haji Senik telah menikahi Nik Limah di Mekah. Perkahwinan ini berlangsung sekitar 1870-an, iaitu setelah beberapa tahun Haji Senik pulang dari Mesir. Seorang anak Tok Chor, Mek Teh telah dikahwinkan dengan seorang lagi ulama Patani yang sedang meningkat naik di Mekah, iaitu Haji Salleh Patani (m. 1908) yang jauh lebih muda berbanding Haji Senik. Hasil perkahwinan ini, Haji Senik dicatatkan mempunyai dua orang anak dengan Nik Limah yang dilahirkan di Mekah. Ini berdasarkan maklumat yang mengatakan ketika Haji Senik balik ke Kelantan selepas peristiwa Angin Besar Kelantan 1880, beliau sudah mempunyai dua orang anak. Namun begitu, anak-cucu Haji Senik tidak dapat memastikan siapakah dua orang anak Haji Senik yang lahir di Mekah itu kerana beliau mempunyai beberapa orang isteri yang masing-masing mempunyai anak. Selain Nik Limah, ada maklumat mengatakan beliau turut mempunyai isteri di Kampung Wakaf dan lain-lain, tetapi maklumat mereka sangat kabur.

Salah seorang isteri beliau yang dapat diketahui dengan jelas ialah Hajah Fatimah binti Awang Hitam atau Awang Bulat yang berasal dari Bukit Merbau, Selising. Hajah Fatimah adalah seorang janda ketika itu, kemudian diperkenalkan kepada Haji Senik ketika beliau berulang-alik mengajar di Bukit Merbau. Hajah Fatimah dikatakan isteri Haji Senik yang paling bongsu dan dinikahi ketika Haji Senik sudah tua atau "sudah tiada gigi." Setelah itu, mereka dikahwinkan dan beberapa tahun kemudian, Hajah Fatimah telah dibawa ke Mekah oleh Haji Senik untuk menunaikan haji. Hajah Fatimah dicatatkan meninggal dunia pada 1959, iaitu 30 tahun selepas suaminya. Hajah Fatimah mempunyai empat orang anak dengan Haji Senik, iaitu:

- i. Haji Che Mamat, murid kepada Tuan Guru Haji Daud Bukit Abal dan menantu kepada Imam Haji Abdullah. Dilantik sebagai Imam Mukim Seligi menggantikan mertuanya sejak sebelum Perang Dunia Kedua. Meninggal dunia pada 1984.
- ii. Hajah Che Bunga, nenek kepada bekas ADUN Selising, Zulkifli Ali melalui anaknya, Che Jah Che Omar (Mak Su Adek). Telah meninggal dunia pada awal 1980-an
- iii. Che Munah, tinggal di Alor Batu, Berangan dan meninggal dunia pada akhir 1980-an.
- iv. Che Omar, mati muda dalam usia awal 20-an pada dekad 1920-an ketika Haji Senik masih hidup.

Adapun anak-anak Haji Senik yang lain daripada beberapa orang ibu, ialah:

- i. Hajah Lijah, ibu kepada Haji Che Ahmad bin Ibrahim bin Nik Hassan
- ii. Haji Abdul Rahman, dipercayai anak Nik Limah kerana beliau lebih tua daripada Imam Haji Che Mamat, anak sulung Hajah Fatimah. Mertua kepada Ustaz Abdul Ghani Musa, lepasan Pondok Pasir Tumbuh dari Terengganu.

- iii. Haji Abdul Aziz, tinggal di Gong Serai, Kampung Panggung dan dikatakan berkebolehan dalam ilmu bacaan al-Quran walaupun tidak setanding dengan ayahnya.

MENINGGAL DUNIA

Haji Senik yang mewarisi darah perjuangan keluarganya dari keluarga diraja Patani telah melalui kehidupan yang sangat mencabar kerana keluarganya sebagai pemerintah Patani telah kehilangan kuasa politik akibat serangan Siam pada 1832. Beliau terpaksa hidup dengan menyembunyikan identiti di Kelantan sebelum bermukim ilmu di Mekah selama 40 tahun. Sebagai anak Melayu pertama yang belajar di Universiti al-Azhar, Mesir, Haji Senik telah mencurahkan bakti sebagai guru agama di Mekah selama hampir 20 tahun. Kemudian beliau mengajar agama di Kelantan sepanjang tiga dekad di antara sekitar 1885 hingga 1915, yang menjadi jumlah keseluruhan perkhidmatan beliau sebagai guru agama sekitar 50 tahun. Sejak berakhirnya Musuh Tok Janggut, Pondok Seligi tidak lagi aktif, bahkan Abdul Rahman Abdullah mengatakan pondok ini aktif di antara 1890 hingga 1920. Antara faktor utama yang menyebabkan Pondok Seligi tidak lagi aktif adalah kerana keuzuran Haji Senik.

Haji Senik mulai uzur dan mengidap sakit tua selepas 1915. Beliau menghadapi masalah pendengaran yang menyukarkannya untuk mengajar al-Quran. Beliau juga sudah terlalu tua untuk bergiat aktif seperti sebelumnya, menyebabkan aktiviti mengajar di surau-surau sekitar Padang Pak Amat hingga ke Selising juga telah terhenti. Sehingga menjelang Bah Air Besar pada 1926, Haji Senik telah berhenti sepenuhnya dari mengajar dan terlantar di rumahnya kerana sakit tua. Beliau dikatakan oleh anak-cucunya bahawa telah meninggal dunia dalam usia sekitar 120 tahun. Menurut catatan sejarah, Haji Senik meninggal dunia dalam tahun 1348H, iaitu satu rentang masa di antara tahun 1929-1930. Jika berdasarkan tahun kematiannya, umur beliau ialah 112 tahun (1818-1930) mengikut kiraan Masehi atau 115 tahun (1233-1348) mengikut kiraan Hijrah. Haji Senik dikebumikan di Tanah Perkuburan Islam Mukim Seligi, Pasir Puteh, iaitu satu kawasan perkuburan yang menempatkan ahli-ahli keluarganya.

SUMBANGAN HAJI SENIK TERHADAP PENGAJIAN AL-QURAN DI KELANTAN

Dengan kedudukan Haji Senik sebagai seorang ulama dan tokoh agama yang terkemuka di Kelantan pada akhir abad ke-19, beliau telah memberikan sumbangan besar kepada perkembangan pendidikan Islam di Kelantan, khususnya dalam bidang pengajian al-Quran. Walaupun nama beliau meningkat naik di Kelantan sejak 1880-an, namun kemasyhuran beliau di kalangan pengkaji sejarah ulama agak pudar kerana pusat kegiatannya terkeluar daripada kawasan Kota Bharu yang menjadi tumpuan para ulama ketika itu. Di Kota Bharu, kebanyakan ulama bergiat di sepanjang Sungai Kelantan dari Salor hingga Pengkalan Leser (Kampung Sireh), memanjang ke Atas Banggol dan Penambang, juga Kampung Laut di seberang sebelah barat. Haji Senik pula memilih untuk 'berkubu' di Kampung Seligi yang agak terpencil di Pasir Puteh, yang menyebabkan beliau tersisih daripada pemerhatian pengkaji. Pun begitu, secara umum, Haji Senik tetap mempunyai sumbangan yang besar di Kelantan.

Sumbangan Haji Senik ini berlaku dalam pelbagai bentuk, khususnya dalam melanjutkan peranan ulama Patani terhadap perkembangan dakwah di Pasir Puteh selepas era Tok Merbol dan Tuan Pengkalan Tangga yang telah membuka pondok sekitar 1830-an. Sebagai seorang ulama yang telah mencipta nama di Mekah sejak pertengahan 1860-an lagi, Haji Senik sebenarnya telah mempunyai ramai murid di kalangan guru-guru agama lepasan Mekah di Kota Bharu. Sejak di Mekah pun, Haji Senik memang terkenal kerana kepakarannya

dalam ilmu al-Quran. Beliau menolak tawaran Sultan Mohammad II untuk dilantik sebagai Mufti Kelantan setelah kematian Mufti Haji Wan Abdul Rahman Muda sekitar 1884, sebaliknya beliau memilih untuk menggerakkan pengajian al-Quran dengan membuka Pondok Seligi. Dari pondok inilah, berkembangannya peranan dan sumbangan Haji Senik terhadap pengajian al-Quran di Kelantan. Di antara sumbangan beliau ialah:

Menubuhkan Pondok Seligi

Penubuhan Pondok Seligi oleh Haji Senik sekitar awal 1880-an, iaitu sebagai sahaja ketibaan beliau dari Mekah pada sekitar 1882 telah melanjutkan peranan beberapa ulama Patani yang awal di Seligi. Pada peringkat awal, beberapa tokoh ulama telah bergiat di sini termasuklah Tok Chor (Tuan Mansor), Imam Haji Hassan, Lebai Salleh dan Haji Ishak Hafiz yang berhijrah dari Patani ke Seligi dan Padang Pak Amat. Setelah Haji Senik balik dari Mekah, beliau telah memilih untuk mewujudkan pusat pengajian Islam di Kampung Seligi, bermula dengan sebuah surau, kemudian berkembang menjadi sebuah kampus pengajian yang biasa disebut sebagai Pondok Seligi. Pondok ini berkembang dengan cepat, sesuai dengan kemasyhuran nama Haji Senik yang sudah terkenal sejak di Mekah lagi. Pondok ini tidak seperti kebanyakan pondok-pondok di Kota Bharu, kerana ia lebih menumpukan kepada pengajian al-Quran berbanding dengan ilmu usuluddin dan fekah yang berkembang di pondok-pondok lain.

Tiada catatan tentang guru-guru lain yang mengajar di pondok ini sepanjang tempoh di antara 1882 hingga 1920, tetapi dapat dipastikan bahawa Haji Senik adalah guru utamanya. Kelebihan yang dimiliki oleh Haji Senik ialah kerana beliau menghafal al-Quran atau disebut oleh murid-muridnya sebagai 'ingat di mulut.' Beliau juga menguasai ilmu tajwid, qiraat, tafsir dan taranum, yang jarang dimiliki oleh ulama-ulama lain secara serentak. Kebolehan ini menjadi daya tarik kepada para pelajar yang berminat untuk mendalami ilmu al-Quran bagi mengunjungi dan belajar di pondok ini. Sehingga zaman kemuncaknya, dicatatkan bahawa terdapat lebih 100 buah pondok yang dibina di sekitar suraunya, yang menunjukkan pada satu-satu masanya itu, pelajarannya berada sekitar 150 hingga 200 orang. Pondok Seligi berfungsi seolah-olah 'Fakulti Pengajian al-Quran' bagi Serambi Mekah pada dekad kedua abad ke-20, melengkapkan peranan Pondok Kenali sebagai Fakulti Bahasa Arab dan Masjid Muhammadi sebagai Fakulti Syariah dan Usuluddin.

Kebolehan dan kepakaran Haji Senik dalam ilmu-ilmu al-Quran telah diperakui oleh para ulama besar di Kota Bharu termasuk oleh Tuan Tabal dan Tok Konok pada generasi 1890-an dan oleh Tok Mesir dan Tok Kenali pada generasi selepas 1900, berdasarkan kedudukan beliau sebagai guru al-Quran yang terkemuka di Mekah sejak 1960-an. Bahkan, guru al-Quran terkenal di Mekah seperti Tok Senggora juga mengakui kepakaran Haji Senik dalam ilmu al-Quran. Kerana itu, sepanjang penglibatannya di Kelantan selama hampir 40 tahun itu, beliau tidak menerima kritikan atau penentangan terhadap ajaran-ajarannya daripada mana-mana ulama Kelantan, bahkan sebahagian daripada lepasan pondok lain yang datang ke Pondok Seligi untuk mendalami ilmu al-Quran secara khusus. Secara umum, Pondok Seligi yang membuatkan Haji Senik dikenali sebagai Haji Senik Seligi adalah antara jasa utama Haji Senik terhadap pengajian al-Quran di Kelantan sejak awal 1880-an hingga akhir 1920-an.

Menyambung peranan ulama terdahulu dalam mengembangkan pengajian al-Quran

Kebangkitan pengajian al-Quran di Kelantan berlaku agak lewat, walaupun telah terdapat ulama-ulama besar dalam pengajian al-Quran di Kelantan sebelum 1880-an. Yang terawal bangkit ialah Sheikh Ibnu Abdul Mu'thi al-Kalantani, penulis kitab *Mir'at al-Quran* (1779) yang disebut oleh Wan Mohd Saghir (2002: 90) sebagai kitab tajwid yang tertua di Nusantara. Oleh kerana Sheikh Ibnu Abdul Mu'thi bergiat di Mekah, beliau hanya melahirkan kader-kader

ulama di sana dan mungkin terdapat anak-anak Kelantan yang berguru dengannya di Mekah. Pada era itu, yang disebut-sebut menjadi guru al-Quran dan bergiat menyalin al-Quran di Kelantan ialah Tok Tebing (Haji Wan Senik), selain Tok Tun Datu, seorang hafiz al-Quran dan Tok Kaabah (Haji Wan Mahmud), guru al-Quran Long Yunus yang terkenal kerana qarinya. Mereka semua dikatakan hidup pada hujung abad ke-18. Pada awal abad ke-19, muncul pula anak Tok Tebing, Haji Wan Zainal Abidin, seorang guru al-Quran yang terkemuka di Pasir Jelatang. Cucu-cucu Haji Wan Zainal seperti Pak Chu Mal (Wan Jamal) dan Tok Wan Buang pula adalah antara ulama al-Quran pada generasi pertengahan abad ke-19.

Memasuki separuh kedua abad ke-19, muncul beberapa tokoh yang dalam pengajian al-Quran di Kelantan termasuklah Haji Che Senik Wan Abdullah, Tok Wan Dir Limbat, Tok Ayah Kubang Bunut al-Hafiz dan Tok Ayah Banggol, yang masing-masing bergiat di Kampung Laut, Pasir Tumbuh, Pasir Mas dan Kota Bharu. Setelah itu, lahir pula generasi penghujung abad ke-19 bermula dengan anak-anak Haji Che Senik Kampung Laut, iaitu Imam Haji Che Samat Kampung Laut dan adiknya, Pak Da Che Ali Kampung Laut, kemudian diikuti oleh Tok Konok di Jalan Merbau dan Tok Mesir di Lorong Gajah Mati. Dikatakan, pada tahun kematian Tok Ayah Kubang Bunut itulah, Haji Senik Seligi telah tiba di Kelantan dan menyertai kelompok Tok Konok dan Tok Mesir dalam meluaskan pengajian al-Quran di Kelantan. Kemunculan tokoh-tokoh ulama ini pada zaman masing-masing telah menjadi tunggak kepada pengajian al-Quran di Kelantan, mamandangkan kebanyakan guru al-Quran yang ada di seluruh Kelantan hanyalah guru-guru al-Quran yang mengajar murid-murid membaca al-Quran di peringkat bawah sahaja.

Walaupun Haji Senik bukanlah peneroka terhadap perkembangan al-Quran di Kelantan dan beliau juga bukanlah guru al-Quran yang terbesar di Kelantan, tetapi kehadiran beliau dalam kelompok ulama-ulama besar bagi pengajian al-Quran telah membentuk kekuatan baru bagi Kelantan. Pada akhir abad ke-19, sekurang-kurangnya ada empat tokoh ulama al-Quran di Kelantan iaitu Tok Imam Haji Che Samat Kampung Laut, Tok Konok, Tok Mesir dan Haji Senik Seligi yang dianggap berada pada level elit di kalangan guru-guru al-Quran. Rata-rata mereka asalnya adalah murid kepada Sheikh Muhammad Adham, guru al-Quran terkemuka di Mekah pada abad ke-19. Ketika Tok Konok (m. 1893), Imam Haji Che Samat (m. 1896) dan Tok Mesir (m. 1909) meninggal dunia, pengajian al-Quran di Kelantan pada dekad 1910-an adalah 'dipimpin' oleh Haji Senik, seperti Tok Kenali memimpin pengajian bahasa Arab. Setelah itu, generasi anak-anak dan anak murid Tok Konok dan Tok Mesir muncul sebagai pelapis pada penghujung dekad 1920-an.

Guru-guru al-Quran yang sezaman dengan Haji Senik di Kelantan pada abad ke-20 termasuklah Tok Kenali Tua, Tok Ayah Kerasak, Haji Wan Tamat Lundang, Haji Nik Mar Dagu Sungai Budor, Haji Yunus Padang Bemban, Haji Omar Kota (bekas guru al-Quran di Mekah), Pak Su Haji Lah Bot, Pak Chu Haji Che Mat Saman Lambor, Haji Nik Man Tua Long Che Su, Haji Abdul Malik Sungai Pinang, Haji Mohd Amin Kubang Kerian dan beberapa anak Tok Konok seperti Haji Nik Abu Bakar, Haji Nik Daud dan Nik Mahmud. Dalam kata lain, memasuki abad ke-20, Kelantan telah pun mempunyai kelompok guru-guru al-Quran yang besar dan ternama. Mereka bukan sahaja mengajar asas al-Quran, tetapi meluaskan pengajian al-Quran daripada ulum al-Quran, tajwid dan tafsir hingga ke qiraat dan taranum. Kemunculan ulama-ulama pelapis pada generasi selepas abad ke-19 ini adalah hasil daripada sumbangan dan peranan bersepadu para ulama al-Quran di Kelantan dan juga Mekah sejak 1850-an lagi, yang berganding bahu dengan ulama dari pelbagai bidang sehingga mengangkat kedudukan Kelantan sebagai Serambi Mekah.

Mengembangkan ilmu taranum di Kelantan

Kemasyhuran qari dan qariah Kelantan dalam ilmu taranum memang diakui ramai, terutama dengan munculnya qari-qariah terkemuka seperti Haji Ahmad Pergau dan Hajah Faridah Mat Saman. Namun begitu, tidak ramai orang mengetahui bagaimana ilmu taranum atau lagu al-Quran berkembang di Kelantan. Berdasarkan sejarah, tokoh-tokoh awal ilmu al-Quran di Kelantan seperti Tok Kaabah, Tok Wan Buang dan Tok Ayah Kubang Bunut adalah qari-qari yang terkemuka, tetapi mereka tidak dicatatkan mempunyai murid yang ternama dalam ilmu taranum. Mungkin kerana keadaan ketika itu yang lebih memerlukan pengajaran ilmu tajwid berbanding taranum, lalu mereka tidak mengembangkan ilmu tersebut kepada masyarakat. Pada generasi Tok Konok, sebagai murid tua Sheikh Mohammad Adham, ilmu taranum atau lagu al-Quran mula dikembangkan di Kelantan. Di antara murid Tok Konok yang terkemuka bukan dari kalangan anaknya ialah Tuan Guru Haji Omar Banggol Kulim yang juga masyhur dengan bacaan al-Qurannya.

Tok Konok adalah antara guru taranum yang tertua di Kelantan sejak 1870-an, tetapi beliau adalah lebih muda daripada Haji Senik dan mati lebih dahulu daripada Haji Senik. Tinggal lagi, Haji Senik telah menghabiskan usia mudanya untuk belajar di Mekah dan Mesir, termasuk sepeguruan dengan Tok Konok di sana. Setelah pulang dari Mesir pada akhir 1860-an, Haji Senik memilih untuk mengajar tajwid, qiraat dan taranum di Mekah hampir 15 tahun, itu hampir sama waktunya dengan kepulangan Tok Konok dari Mekah ke Kelantan pada awal 1870-an dan memulakan kegiatan kelimuannya di Jalan Merbau, Kota Bharu serentak dengan Tuan Tabal di Lorong Tok Semian. Seketika selepas Tok Konok meninggal dunia, Tok Mesir pula membuka pusat pengajian taranum di Lorong Gajah Mati. Haji Senik sebenarnya sempat mengajar sezaman dengan Tok Konok di Kelantan dan sempat pula mengajar sezaman dengan Tok Senggora di Mekah. Tok Senggora adalah berpangkat anak kepada Haji Senik dan Tok Konok, tetapi beliau muncul sebagai guru al-Quran terkemuka di Mekah, dan ramai anak Kelantan berguru dengannya.

Tok Senggora dikatakan lahir pada 1850 dan pergi ke Mekah sejak berumur enam tahun. Dalam ilmu al-Quran, beliau dikatakan belajar dengan '200 orang guru.' Selain ulama-ulama Arab, yang mengajar al-Quran di Mekah sejak 1860-an hingga 1880-an ialah ulama-ulama Melayu, mungkin termasuk Haji Senik sendiri. Dalam hal ini, tidak mustahil jika Tok Senggora juga merupakan di antara murid-murid Haji Senik di Mekah. Hal ini berlaku kerana Haji Senik adalah ulama Melayu yang terbesar di Mekah dalam ilmu al-Quran dewasa itu. Yang agak menarik, salah seorang guru al-Quran terbesar Kelantan selepas merdeka ialah Mufti Haji Mohammad Nor Ibrahim (Ayah Nor Penambang, m. 1987) adalah salah seorang murid Tok Senggora yang terkenal. Sebagai murid Tok Senggora, beliau dicatatkan mempunyai cara yang berbeza dalam sebutan huruf *qalqalah*, jika dibandingkan dengan sebutan murid-murid Tok Konok. Jika benar Tok Senggora pernah belajar ilmu al-Quran dengan Haji Senik di Mekah, maka sebarisan ulama besar Kelantan pada abad ke-20 adalah cucu murid kepada Haji Senik sendiri.

Berbalik kepada perkembangan ilmu taranum, selain Tok Konok dan Tok Senggora, tokoh-tokoh seperti Tok Imam Che Samat dan Tok Mesir juga mempunyai peranan yang besar. Berdasarkan kedudukan mereka berdua sebagai pelajar di Mekah pada dekad 1860-an dan 1870-an, juga tidak mustahil bahawa mereka adalah murid-murid Haji Senik di Mekah, ketika Mufti Haji Wan Mat Perak juga menadahi Haji Senik di sana. Tok Imam Haji Che Samat adalah anak kepada Haji Che Senik, seorang guru al-Quran dari Mentuan, tapi berhijrah ke Kampung Laut. Beliau dan adiknya, Pak Da Che Ali naik ke Mekah pada awal 1870-an dan dikatakan murid bongsu Sheikh Mohammad Adham. Dipercayai mereka berdua juga belajar al-Quran dengan Haji Senik, sebelum menadahi Sheikh Mohammad Adham dan ulama-ulama lain. Hal yang sama juga dialami oleh Tok Mesir sebelum beliau berangkat ke Mesir, mungkin dengan

pengaruh Haji Senik juga. Tok Imam Haji Che Samat tidak terkenal kerana melahirkan murid-murid, tetapi beliau terkenal kerana menjadi Imam Masjid Besar Kota Bharu (Masjid Buruk) sezaman dengan Mufti Haji Nik Wan Daud.

Tok Mesir yang balik ke Kelantan pada tahun kematian Tok Konok, iaitu kemudian sedikit daripada Haji Senik, telah membuka pusat pengajiannya di Lorong Gajah Mati. Suraunya mendapat sambutan besar kerana kedudukan strategiknya. Beliau dianggap ‘bapa taranum’ Kelantan. Beliau telah mengajarkan ilmu taranum kepada murid-murid pondok yang telah alim di Kota Bharu, sedangkan Haji Senik lebih memberi fokus kepada pengajian tajwid di Kampung Seligi kepada pelajar-pelajar baru. Murid-murid senior Haji Senik mempelajari taranum kemudian. Hal ini telah membuatkan nama Tok Mesir lebih disebut-sebut, berbanding Haji Senik. Jika benar Tok Mesir dan Tok Imam Che Samat adalah murid-murid Haji Senik di Mekah, maka sejumlah besar murid-murid Tok Mesir adalah cucu murid kepada Haji Senik. Di antara murid Tok Mesir yang masyhur dengan lagu al-Quran termasuklah Tok Ayah Kerasak, Haji Lah Paya Senang, Haji Latif Bilal Masjid Kota Bharu, Imam Haji Said, Awang Ahmad Qari, Tok Lebai Daud Jelujuk, Haji Abdullah Seri Padang Keluchor, Tok Alim Kampung Lating dan lain-lain.

Di Pondok Seligi sendiri, walaupun tidak banyak nama besar yang timbul dalam bidang taranum, namun ia tetap ada peranan tersendiri. Faktor sebenarnya Pondok Seligi tidak muncul sebagai sekolah yang melahirkan ahli taranum atau lagu al-Quran yang besar adalah kerana tumpuan Haji Senik sendiri yang sudah tua ketika itu untuk mengembangkan pengajian tajwid al-Quran yang dianggap lebih penting. Beliau lebih banyak mengajar tajwid dan tafsir al-Quran kepada masyarakat, sedangkan ilmu taranum hanya diajar kepada murid-murid senior sahaja, sehingga dapat melahirkan sejumlah agamawan yang menjadi imam dan guru-guru al-Quran di sekitar Pasir Puteh dan Kota Bharu. Di antara murid-murid beliau di Seligi yang terkenal kerana kebolehan melagukan al-Quran termasuklah Haji Awang Puteh Permatang Gading, Haji Derahman Mat Diah Seligi, Tok Khatib Haji Ismail Permatang Sungkai, Tok Ayah Him Kampung Wakaf dan lain-lain. Anak beliau sendiri, Tok Imam Haji Che Mamat Seligi dan Haji Abdul Aziz Kampung Panggung adalah antara qari yang terkemuka di kalangan murid-muridnya.

Memasyarakatkan pengajian al-Quran

Salah satu peranan istimewa Haji Senik ialah kesungguhan beliau untuk memasyarakatkan pengajian al-Quran sehingga menghilangkan kemasyhurannya. Beliau sudah pasti dapat mencipta nama besar di Kelantan sebagai seorang guru taranum atau qiraat, sesuai kepakarannya, tetapi kerana beliau melihat bahawa meluaskan pengajian al-Quran kepada masyarakat adalah lebih penting daripada mengajar qiraat dan taranum, maka namanya tidak semasyhur Tok Mesir dalam bidang ini. Selain mengajar al-Quran di Pondok Seligi, Haji Senik sebenarnya telah menjadikan surau-surau di kampung sekitar Kampung Seligi sebagai tempat beliau mengajar al-Quran. Biasanya guru-guru pondok akan memberi tumpuan untuk mengajar di pondoknya sahaja dan para pelajar perlu mendatangi guru di pondok untuk belajar. Haji Senik mengambil sikap yang berbeza kerana menyedari bahawa masyarakat awam masih jauh daripada al-Quran dan sebahagian mreka belum menguasai ilmu asas al-Quran.

Atas sebab itu, beliau mengambil pendekatan untuk turun ke bawah dengan mengajar di surau-surau di sekitar Padang Pak Amat hingga ke Selising, yang mana Kampung Seligi terletak di antara keduanya. Selain berdakwah dan mengajar ilmu agama, pengajaran ilmu al-Quran adalah tumpuan utama beliau. Sepanjang tempoh 40 tahun bergiat di Kampung Seligi itu, Haji Senik dikatakan turut mengajar setiap malam dan hari minggu di Kampung Berangan, Alor Hijau, Bukit Merbau dan kampung-kampung sekitar Selising, selain turut mengajar di Bukit Abal dan kawasan Sungai Kelong seperti Kampung Wakaf, Gong Serai, Panggung, Batu

Sebutir, Permatang Gading, Permatang Sungkai, Kubang Sawa dan kampung-kampung lain sekitar Padang Pak Amat. Ternyata pendekatan ini telah menggalakkan orang kampung belajar al-Quran walaupun bukan setiap malam, tetapi secara berjadual. Ada sesetengah riwayat mengatakan di antara sebab Haji Senik mempunyai ramai isteri adalah kerana kegiatan pengajaran al-Quran ini.

Beliau bukan sahaja ditawarkan oleh masyarakat setempat untuk berkahwin, tetapi berkahwinan untuk memudahkan urusan logistik setiap kali beliau turun mengajar. Beliau mempunyai isteri di Seligi, Bukit Merbau, Kampung Panggung dan lain-lain, iaitu kampung yang menjadi satelit pengajarannya. Beliau mengatur jadual kuliah dan kelas al-Qurannya mengikut lokaliti rumah isterinya yang menyebabkan selain Kampung Seligi, kawasan sekitar Selising (bersatelit di Bukit Merbau) dan kawasan sekitar Padang Pak Amat (bersatelit di Kampung Panggung) turut mendapat limpahan daripada kegiatan ilmunya. Murid-murid beliau, terutama di kalangan orang dewasa yang mengikuti kuliah umum dan kelas al-Quran bertebaran di kawasan-kawasan tersebut, sedangkan pelajar sepenuh masa dan orang-orang dewasa yang memperdalamkan bacaan al-Quran, belajar qiraat dan juga taranum, mereka tertumpu di Pondok Seligi. Selain penduduk tempatan, pelajar dari Terengganu dan Perak juga belajar di sini.

Melahirkan tokoh-tokoh al-Quran untuk Kelantan

Kemunculan Haji Senik sebagai tokoh ulama al-Quran telah pun bermula sejak 1850-an lagi di Mekah, iaitu setelah hampir 20 tahun beliau berguru di sana dengan ulama-ulama besar dalam ilmu al-Quran. Di antara guru-guru beliau ialah Sheikh Saruji dan Sheikh Mohammad Adham. Beberapa guru lain yang terkemuka dalam ilmu al-Quran mungkin turut ditadahnya seperti Sheikh Hassan Badir al-Muqri, Sheikh Muhammad ad-Dairi at-Tahaami, Sheikh Ahmad Ridah Salmunah, Sheikh Sulaiman al-Barbari, Sheikh Ibrahim Saad al-Masri dan lain-lain. Setelah hampir dua dekad berguru itu, Haji Senik sudah layak untuk mengajar di Mekah, tetapi beliau memilih untuk ke Mesir bagi memperdalamkan ilmunya selama enam tahun, menjadikan jumlah tahun pengajian 25 tahun. Ketika beliau kembali ke Mekah pada akhir 1860-an, beliau telah menjadi seorang guru yang terhormat dalam bidang al-Quran. Beliau telah dikunjungi oleh pelajar-pelajar Melayu yang baru tiba dari Alam Melayu untuk belajar al-Quran dengannya.

Kemasyhuran Haji Senik dalam bidang al-Quran ini setaraf dengan kemasyhuran Sheikh Wan Ahmad al-Fathani, Sheikh Nik Dir, Tok Wan Ali Kutan, Sheikh Nik Mat Kechik dan Sheikh Wan Mohd Zain dalam bidang-bidang lain di Mekah. Sebagai mana tradisi ulama-ulama Melayu ketika mengunjungi Mekah untuk belajar, mereka akan terlebih dahulu berguru dengan ulama-ulama besar di kalangan orang Melayu, sebelum pergi kepada ulama dari Indonesia seperti Sheikh Nawawi Banten atau Sheikh Ahmad Khatib Minangkabau, dan akhirnya berguru dengan ulama-ulama Arab pula. Bagi ulama-ulama Melayu yang berada di Mekah pada sekitar 1860-an dan 1870-an untuk mendalami ilmu al-Quran, hampir pasti mereka berguru dengan Haji Senik. Ini termasuklah Haji Che Samat Kampung Laut, Pak Da Che Ali Kampung Laut, Tok Mesir, Tok Senggora, Haju Nuh Jamaluddin al-Kalantani, Haji Omar Kota dan lain-lain. Hampir mustahil untuk mengatakan mereka tidak berguru dengan Haji Senik.

Kerana peranan beliau dalam pengajaran al-Quran di Mekah, sehingga dekad 1920-an, nama Haji Senik masih masyhur di Mekah kerana jasanya dalam ilmu al-Quran. Anak-anaknya dan murid-muridnya yang dihantar belajar di Mekah meriwayatkan bahawa apabila mereka tiba di Mekah dan memberitahu bahawa mereka adalah murid Haji Senik, orang Mekah akan menyuruh mereka membaca al-Quran lantaran masyhurnya nama Haji Senik dengan lagu-lagu al-Qurannya. Bahkan, terdapat riwayat yang agak mengelirukan dengan mengatakan Haji Senik belajar lagu al-Quran dengan Tok Senggora di Mekah, sedangkan Tok Senggora adalah

masih remaja ketika Haji Senik menjadi guru di Mekah.²¹ Yang lebih tepat ialah Haji Senik dikunjungi oleh Tok Senggora untuk belajar ilmu al-Qurannya, sebagai salah seorang daripada 200 orang gurunya. Dalam kata lain, Haji Senik Ketika berada di Mekah telah berhasil melahirkan guru-guru al-Quran, yang sebahagiannya bergiat di Kelantan dan sebahagiannya di Mekah dan tempat-tempat lain.

Walaupun tokoh-tokoh al-Quran tidak banyak dilahirkan oleh Haji Senik di Kelantan berbanding dengan muridnya, namun beliau telah berjaya melahirkan tokoh-tokoh al-Quran yang berkhidmat sebagai imam, khatib, bilal dan guru-guru al-Quran di kampung masing-masing seperti yang disebutkan sebelum ini. Yang lebih patut dibanggakan ialah peranan murid-murid di Mekah yang telah melahirkan lapisan-lapisan murid generasi baru sama ada di Mekah mahupun di Kelantan, yang kemudiannya berkhidmat sebagai guru al-Quran di Kelantan. Selepas 1900, Kelantan bukan sahaja dilimpahi oleh ulama-ulama, tetapi juga guru-guru al-Quran yang sangat ramai, termasuk pakar dalam bidang tajwid, qiraat, taranum dan tafsir. Kelahiran generasi ulama taranum yang ramai di Kelantan yang sering digelar sebagai 'tukang lagu,' 'orang suara molek,' 'qari' dan lain-lain adalah sebahagian daripada tokoh-tokoh al-Quran yang lahir daripada kegiatan Haji Senik di Mekah dan di Kelantan sejak 1850-an itu.

PENUTUP

Kehadiran Haji Senik yang berasal dari keturunan Raja Patani ke Kelantan pada 1830-an telah membuka kehidupan baru baginya, daripada seorang putera raja menjadi seorang ulama yang terkemuka. Keperitan hidupnya setelah Patani jatuh ke tangan Siam pada 1832 diikuti oleh pembunuhan seluruh ahli keluarganya oleh Siam telah membuatkan Haji Senik bertekad meninggalkan Kelantan dan belajar agama di Mekah sehingga muncul sebagai seorang ulama besar 40 tahun kemudian. Beliau telah bangkit sebagai seorang ulama besar dalam bidang al-Quran setelah berguru dengan beberapa ulama Arab yang terkemuka di Mekah. Haji Senik turut mencipta sejarah sebagai anak Melayu pertama yang belajar di Universiti al-Azhar pada dekad 1860-an, sebelum beliau sendiri mengajar agama di Mekah selama hampir 15 tahun. Haji Senik dengan latar belakang pendidikan yang cemerlang itu telah ditekuni oleh ulama-ulama di Mekah sehingga dapat melahirkan pula para ulama yang menguasai ilmu al-Quran pada generasi berikutnya.

Setelah pulang ke Kelantan pada awal dekad 1880-an, Haji Senik menolak tawaran untuk menjadi mufti, sebaliknya beliau memberi tumpuan dengan mengajar al-Quran dan membuka pondok di Kampung Seligi dan berkhidmat di sini hampir 40 tahun sehingga tercetusnya Perang Tok Janggut pada 1915. Selepas perang ini, beliau mulai beransur-ansur berhenti mengajar kerana usianya terlalu tua dan menghadapi masalah pancaindra. Sepanjang menjadi guru al-Quran, beliau telah memberi fokus untuk melahirkan masyarakat yang menguasai ilmu asas pembacaan al-Quran, khususnya tajwid berbanding ilmu qiraat dan taranum. Beliau telah turun ke kampung-kampung di sekitar Pasir Puteh untuk mengajar al-Quran, selain mengajar di pondok sehingga menyebabkan ilmu al-Quran tersebar dalam masyarakat. Sebagai seorang ahli tasawuf yang wara', beliau tidak mementingkan kemasyhuran namanya sebagai guru al-Quran, sebaliknya beliau memberi penekanan terhadap peningkatan keupayaan masyarakat dalam menguasai ilmu al-Quran, sehingga beliau sanggup turun ke akar umbi masyarakat bagi meluaskan penyebaran ilmu ini.

²¹ Ismail Che Daud, 2007. Ulama' Muhajirin di Kelantan, dlm. Tokoh-tokoh Ulama' Semenanjung Melayu (2), MAIK, Kota Bharu, hal. 553.

Perkhidmatan beliau sebagai guru al-Quran di Mekah dan Kelantan sebenarnya mencecah 50 tahun, di mana hampir 25 tahun digunakan untuk belajar di Mekah dan Mesir. Sepanjang tempoh 50 tahun ini, sumbangan Haji Senik terhadap pengajian al-Quran di Kelantan adalah sangat besar. Antaranya, termasuklah penubuhan Pondok Seligi sebagai 'Fakulti Pengajian al-Quran' di Kelantan, yang sekali gus telah menyambung peranan ulama-ulama terdahulu dalam mengembangkan ilmu al-Quran. Dalam konteks ilmu al-Quran, selain ilmu tajwid, tafsir dan qiraat, antara sumbangan besar Haji Senik ialah dalam bidang lagu al-Quran atau taranum. Beliau yang terkenal sebagai guru taranum di Mekah telah memperturunkan ilmu ini kepada ulama-ulama Melayu termasuk Tok Senggora yang kemudiannya menjadi antara ulama yang paling terkenal dalam ilmu melagukan al-Quran. Ketika ulama-ulama generasi baru sedang memperkenalkan lagu atau taranum al-Quran, Haji Senik pula bertindak meluaskan pengajian al-Quran masyarakat supaya wahyu Allah dapat membumi.

RUJUKAN

Buku dan kertas kerja

- Abdullah Mohamed (Nakula), 1980. *Sejarah Kelantan: Beberapa Lintasan*. Kertas kerja No. 13, Seminar Sejarah dan Budaya Wilayah Kelantan, 12-15 April.
- Abdul Rahman Abdullah, 1997. *Pemikiran Islam di Malaysia: Sejarah dan Aliran*. Gema Insani Press, Jakarta.
- Ahmad Fathy al-Fathani, 1994. *Pengantar Sejarah Patani*. Pustaka Darussalam. Alor Setar.
- Teeuw & D.K Wyatt, 1970. *Hikayat Patani and The Story of Patani*. Koninklijk Instituut, Voor Taal-Land-en Volkenkunde, The Hague.
- Ibrahim Syukri, 2005. *Sejarah Kerajaan Melayu Patani*. Penerbit UKM, Bangi.
- Ismail Che Daud, 2012. *Tokoh-tokoh Ulama' Semenanjung Melayu* (1). Majlis Agama Islam dan Adat Istiadat Melayu Kelantan, Kota Bharu.
- Ismail Che Daud, 2007. *Tokoh-tokoh Ulama' Semenanjung Melayu* (2). Majlis Agama Islam dan Adat Istiadat Melayu Kelantan, Kota Bharu.
- Mohd Fadli Ghani, 2022. *50 Tokoh Tersohor Kelantan Darul Naim*, Jld. 1. Perbadanan Muzium Negeri Kelantan, Kota Bharu.
- Wan Mohd Saghir Abdullah, 2002. *Wawasan Pemikiran Islam Ulama Asia Tenggara*, Jld. 5. Khazanah Fathaniyah, Kuala Lumpur.
- Wan Mohd Saghir Abdullah, 2005. *Syeikh Ahmad al-Fathani: Pemikir Agung Melayu dan Islam*, Jld. 1. Khazanah Fathaniyah, Kuala Lumpur.

Internet

- http://pp-sk.blogspot.com/2013/12/patani-kelantan-episod-7-tuan-besar_13.html?m=1
- Christopher Buyers, Royal Ark. www.royalark.net/Malaysia/kelant4.htm
- Mohd Fadli Ghani, 2022. Haji Senik Seligi: Ulama Melayu Pertama di al-Azhar. <https://harakahdaily.net/index.php/2022/06/27/haji-senik-seligi-ulama-melayu-pertama-di-al-azhar/>
- Wan Amir, facebook.

Temuramah

- Che Noh Che Mamat, 2022. Temuramah melalui telefon dari London beberapa kali antara April-Okt. Haji Che Noh adalah cucu kepada Haji Senik.
- Kossim Abdul Ghani, 2022. Temuramah di Bandar Tasik Puteri, Rawang pada 30 September 2022. Ustaz Kossim Abdul Ghani adalah cicit Haji Senik.

Wan Azman Wan Ali, 2022. Temuramah di Kampung Kota, Kota Bharu pada 18 dan 22 Jun 2022. Cikgu Wan Azman adalah cicit Haji Senik.



UNIVERSITI



MALAYSIA

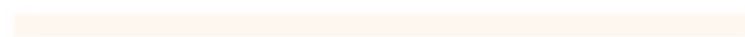

KELANTAN

Hidroterapi Wudhu' Sebagai Rawatan Alternatif Bagi Manfaat Kesehatan Emosi dan Intelek

Ezzah binti Mohd Adam
*Calon Sarjana Program Pengajian al-Quran dan Sunnah,
Fakulti Pengajian Islam, Universiti Kebangsaan Malaysia,
43600 Bangi, Selangor Darul Ehsan, Malaysia
p119423@siswa.ukm.edu.my*

Latifah binti Abd Majid
*Fakulti Pengajian Islam, Universiti Kebangsaan Malaysia,
43600 Bangi, Selangor Darul Ehsan, Malaysia
umilm@ukm.edu.my*

ABSTRAK

Masyarakat hari ini menghadapi pelbagai cabaran dari segi pembentukan sosial dan pembangunan ekonomi menyebabkan masalah kesihatan emosi dan intelek terganggu kemudian semakin serius ketika dan pasca pandemik. Pelbagai cara rawatan dan kaedah alternatif digunakan bagi memastikan emosi yang stabil dan pemikiran yang positif antaranya melalui hidroterapi wudhu'. Rawatan alternatif hidroterapi wudhu' menggunakan medium air yang dikenakan pada anggota-anggota wudhu' dengan pergerakan yang perlahan dan tenang serta pemikiran yang fokus. Walaupun ramai yang mengetahui pergerakan dan amalan berwudhu' namun masih kurang pendedahan akan manfaatnya terhadap kesihatan emosi dan intelek. Metodologi kajian ini ialah metode kualitatif. Kajian kepustakaan dan analisis dokumen dijalankan untuk mendapatkan maklumat dan menganalisis data. Kelebihan dan manfaat hidroterapi wudhu' sebagai rawatan alternatif bagi kesihatan intelek dan emosi dapat menjadikan fikiran lebih tenang dan fokus. Keadaan ini menjadikan seseorang itu lebih ceria, dapat mengurangkan stres dan mengawal kemarahan sekaligus memberi motivasi dan dorongan kepada masyarakat untuk melazimi amalan berwudhu'.

Kata Kunci: *hidroterapi; wudhu'; kesihatan; emosi; intelek*

PENDAHULUAN

Dalam menghadapi pelbagai cabaran masa kini dan keadaan kesihatan yang tidak menentu, sudah pasti bermacam cara dan kaedah serta alternatif yang digunakan untuk menyelesaikan masalah tersebut. Hidroterapi wudhu' adalah salah satu amalan terapi yang boleh dipraktikkan untuk mengurangkan risiko penyakit berjangkit, masalah saraf dan kesihatan mental seperti cemas dan stres bahkan menjadi amalan dalam menjaga kebersihan. Beberapa kajian tentang kelebihan hidroterapi wudhu' telah dijalankan oleh pengkaji-pengkaji untuk melihat kesannya terhadap kesihatan manusia.

Secara umumnya, hidroterapi banyak digunakan dalam jabatan fisioterapi hospital bagi membantu pesakit kerana hidroterapi merupakan salah satu kaedah pemulihan dalam bidang fisioterapi. Fisioterapi adalah rawatan bagi pesakit yang mengalami kelumpuhan atau gangguan saraf (otot) secara senaman, urut, atau dengan menggunakan cahaya, haba, air dan lain-lain (Kamus Dewan Edisi Keempat). Hidroterapi secara amnya lebih tertumpu pada pergerakan yang perlahan, terkawal dan relaksasi bagi membantu proses pemulihan dan rawatan. Menurut Kamus Dewan Edisi Keempat bahawa hidroterapi (hidrotérapí) bermaksud (ubat) kaedah rawatan penyakit tertentu dengan menggunakan air pada luar tubuh.

Manakala perbuatan wudhu' adalah salah satu perintah daripada Allah S.W.T. Wudhu' berasal daripada perkataan wadha'ah (وَضَاءَةٌ). Dari segi bahasa, ia bererti elok dan berseri. Perkataan wadhu' (وَضُوءٌ) ialah nama air yang digunakan untuk berwudhu', adapun wudhu' adalah perbuatan wudhu' itu sendiri (Mustofa Al-Khin et al. 2011). Manakala dari sudut istilahnya, wudhu' ialah penggunaan air yang suci pada anggota tertentu (iaitu membasuh muka, dua belah tangan hingga ke siku, menyapu kepala dan membasuh kedua-dua belah kaki) dan dimulai dengan niat.

Berwudhu' juga merupakan amalan sunnah yang dianjurkan oleh Rasulullah S.A.W. Hadith yang diriwayatkan daripada Saidina Anas bin Malik, beliau berkata:

كَانَ رَسُولُ اللَّهِ صَلَّى اللَّهُ عَلَيْهِ وَسَلَّمَ يَتَوَضَّأُ عِنْدَ كُلِّ صَلَاةٍ، قُلْتُ: كَيْفَ كُنْتُمْ تَصْنَعُونَ؟ قَالَ: يَجْزِي أَحَدَنَا
الْوَضوءُ مَا لَمْ يَحْدِثْ

Maksudnya: Sesungguhnya Rasulullah SAW berwudhu' pada setiap kali solat. Aku bertanya: Bagaimanakah kalian (para sahabat) lakukan? Beliau (Anas R.A.) menjawab: Pada kami cukup hanya satu wudhu' sahaja jika tidak berhad. (Riwayat al-Bukhari no. 214 dan al-Baihaqi no. 761)

Hadith ini menunjukkan bahawa Baginda sentiasa memelihara wudhu' dan memperbaharunya adalah afdhal.

METODOLOGI KAJIAN

Metodologi kajian yang digunakan ialah kaedah kualitatif dengan beberapa metode yang lain seperti kajian kepustakaan dan analisis dokumen bagi mendapatkan maklumat yang diperlukan dan mengumpulkan teori bagi penulisan ini. Kitab tafsir mukatabar menjadi rujukan antaranya tafsir Ibn Kathir. Takhrij dan penjelasan hadith pula, Kutub Sittah digunakan. Selain daripada itu, perpustakaan atas talian dimanfaatkan dalam mendapatkan artikel-artikel dan membantu penulis mendapatkan bahan yang lebih banyak.

Analisis dokumen diambil dari penulisan artikel jurnal dan kajian-kajian lepas yang dijalankan melibatkan artikel pengkaji di Malaysia dan kajian oleh pengkaji di Indonesia serta kajian barat. Data-data yang diperolehi akan dikumpul dan dianalisis mengikut sorotan literatur yang dikaji dan dipersembahkan dalam bentuk penulisan dan penerangan bagi setiap satunya.

PERNYATAAN PERMASALAHAN KAJIAN

Pada masa kini, banyak masalah kesihatan yang dihadapi oleh masyarakat bukan sahaja di Malaysia malah di seluruh dunia. Masalah kesihatan yang berlaku bukan sahaja berada di lingkungan persekitaran atau keadaan fizikal malah masalah kesihatan mental juga menjadi satu trend yang amat membimbangkan pasca pandemik Covid-19. Amir & Haziq (2020) menyatakan bahawa terdapat 11,791 panggilan telefon yang diterima oleh Unit talian bantuan sokongan psikososial setakat Oktober 2020, di mana 50 peratus adalah berhadapan dengan tekanan emosi. (Abdul Aziz, A., Mohd Sukor, N., & Ab Razak, N. 2020).

Tekanan emosi jika tidak dapat dikawal boleh membawa kepada perilaku kekerasan, mencederakan diri dan perbuatan berunsur jenayah. (Ike Rizki, 2018) Walaupun rawatan hidroterapi wudhu' memerlukan tempoh dan masa bagi melihat keberkesanannya terhadap sesuatu masalah kesihatan, namun hasilnya mampu memberi impak yang positif (Wardani et

al. 2020). Hasil kajian sebegini boleh digunakan untuk membantu seseorang yang mengalami tekanan beransur tenang dan merasa lebih positif.

Amalan berwudhu' kurang diamalkan oleh masyarakat walaupun ia adalah salah satu sunnah yang dituntut. Kupasan hadis-hadis mengenai kelebihan berwudhu' sedikit sebanyak dapat memberi kesedaran dan motivasi kepada individu dan masyarakat untuk sentiasa melazimi amalan berwudhu'.

BERWUDHU' MENURUT AL-QURAN DAN HADITH

Allah S.W.T memerintahkan dengan jelas untuk bersuci sebelum menunaikan solat, dengan mengangkat hadas kecil melalui berwudhu'. Firman Allah di dalam surah al-Maidah ayat ke 6 dinyatakan seperti berikut;

يَا أَيُّهَا الَّذِينَ آمَنُوا إِذَا قُمْتُمْ إِلَى الصَّلَاةِ فَاغْسِلُوا وُجُوهَكُمْ وَأَيْدِيَكُمْ إِلَى الْمَرَافِقِ وَامْسَحُوا بِرُءُوسِكُمْ وَأَرْجُلَكُمْ إِلَى الْكَعْبَيْنِ وَإِنْ كُنْتُمْ جُنُبًا فَاطَّهَّرُوا وَإِنْ كُنْتُمْ مَرْضَىٰ أَوْ عَلَىٰ سَفَرٍ أَوْ جَاءَ أَحَدٌ مِّنْكُمْ مِنَ الْغَائِطِ أَوْ لَمَسْتُمُ النِّسَاءَ فَلَمْ يَجِدُوا مَاءً فَتَيَمَّمُوا صَعِيدًا طَيِّبًا فَامْسَحُوا بِوُجُوهِكُمْ وَأَيْدِيكُمْ مِنْهُ مَا يُرِيدُ اللَّهُ لِيَجْعَلَ عَلَيْكُمْ مِنْ حَرَجٍ وَلَكِنْ يُرِيدُ لِيُطَهِّرَكُمْ وَلِيَسِّرَ نِعْمَتَهُ عَلَيْكُمْ لَعَلَّكُمْ تَشْكُرُونَ .

Maksudnya: Wahai orang-orang yang beriman! Apabila kamu hendak melaksanakan solat, maka basuhlah wajahmu dan tanganmu sampai ke siku, dan sapulah kepalamu dan (basuh) kedua kakimu sampai ke kedua kaki hingga ke buku lali. Jika kamu berjunub, maka mandilah. Dan jika kamu sakit atau dalam perjalanan atau kembali dari tempat buang air atau menyentuh perempuan, maka jika kamu tidak memperoleh air, maka bertayamumlah dengan debu yang baik (suci); usaplah wajahmu dan tanganmu dengan (debu) itu. Allah tidak ingin menyulitkan kamu, tetapi Dia hendak membersihkan kamu dan menyempurnakan nikmat-Nya bagimu, agar kamu bersyukur. (6)

Ibnu Kathir di dalam kitab tafsirnya ada menyebut ketika menerangkan ayat ini dengan hadis yang diriwayatkan oleh Imam Muslim dari Abu Malik As-Syaari bahawa Rasulullah S.A.W bersabda: “Kebersihan sebahagian daripada iman..”. Wudhu' adalah salah satu nikmat daripada Allah yang dinyatakan pada ayat ke 7 surah al-Maidah, bukan sahaja nikmat pembersihan jasmani tetapi juga pembersihan rohani. (Yusuf 2018)

Selain berwudhu' untuk melaksanakan solat, dalam dalil-dalil lain kita dianjurkan berwudhu' ketika tawaf di Baitullah, membaca Al-Qur'an, berzikir dan berdo'a kepada Allah, ketika hendak tidur, sesudah muntah, ketika hendak tidur dalam keadaan berjunub dan lain-lain.

Menurut Oan Hasanudin (2007), dalam bukunya Mukjizat Berwudhu ayat tersebut membawa dua perkara: Pertama, untuk pembersihan diri dan penyempurnaan nikmat Allah SWT yang diberikan kepada manusia. Kedua, wudhu' tersebut iaitu kesucian atau kebersihan dan penyempurnaan nikmat kesihatan secara holistik, baik jasmani maupun rohani. Hal ini sebagaimana yang dinyatakan oleh baginda Rasulullah SAW di dalam hadis riwayat Imam Muslim melalui jalur Suwaid bin Sa'id (Afif & Khasanah 2019):

حَدَّثَنَا سُؤَيْدُ بْنُ سَعِيدٍ ، عَنْ مَالِكِ بْنِ أَنَسٍ ، ح ، وَحَدَّثَنَا أَبُو الطَّاهِرِ ، وَاللَّفْظُ لَهُ أَخْبَرَنَا عَبْدُ اللَّهِ بْنُ وَهْبٍ ، عَنْ مَالِكِ بْنِ أَنَسٍ ، عَنْ سُهَيْلِ بْنِ أَبِي صَالِحٍ ، عَنْ أَبِيهِ ، عَنْ أَبِي هُرَيْرَةَ ، أَنَّ رَسُولَ اللَّهِ صَلَّى اللَّهُ عَلَيْهِ ،

وَسَلَّمَ قَالَ : إِذَا تَوَضَّأَ الْعَبْدُ الْمُسْلِمُ - أَوْ الْمُؤْمِنُ - فَعَسَلَ وَجْهَهُ حَرَجَ مِنْ وَجْهِهِ كُلِّ حَاطِيَةٍ نَظَرَ إِلَيْهَا بِعَيْنَيْهِ مَعَ الْمَاءِ - أَوْ مَعَ آخِرِ قَطْرِ الْمَاءِ - ، فَإِذَا عَسَلَ يَدَيْهِ حَرَجَ مِنْ يَدَيْهِ كُلِّ حَاطِيَةٍ كَانَتْ بَطَشَتْهَا يَدَاهُ مَعَ الْمَاءِ أَوْ مَعَ آخِرِ قَطْرِ الْمَاءِ - ، فَإِذَا عَسَلَ رِجْلَيْهِ حَرَجَتْ كُلُّ حَاطِيَةٍ مَشَتْهَا رِجْلَاهُ مَعَ الْمَاءِ - أَوْ مَعَ آخِرِ قَطْرِ الْمَاءِ - حَتَّى يَخْرُجَ نَفِيًّا مِنَ الذُّنُوبِ

Maksudnya: “Telah menceritakan kepada kami Suwaid bin Sa’id dari Malik bin Anas. (dalam riwayat lain disebutkan) Dan telah menceritakan kepada kami Abu ath-Thahir dan lafaz tersebut miliknya, telah mengkhabarkan kepada kami Abdullah bin Wahab dari Malik bin Anas dari Suhail bin Abu Shalih dari bapanya dari Abu Hurairah bahawa Rasulullah SAW bersabda: “Apabila seorang muslim atau mukmin berwudhu’, lalu membasuh wajahnya, maka keluar dari wajahnya segala kesalahan yang dia lihat dengan kedua matanya bersama turunnya air wudhu’, atau bersama akhir dari titisan air. Apabila dia membasuh kedua tangannya, maka keluar dari kedua tangannya semua kesalahan yang dilakukan oleh kedua tangannya bersama dengan turunnya air, atau akhir dari titisan air hingga dia keluar dalam keadaan bersih dari dosa.” (HR. Imam Muslim no. 360).

Hadith di atas berstatus mutawatir melalui periwayatan jalur Imam Muslim yang diriwayatkan oleh Abu Hurairah kerana diriwayatkan lebih dari seorang perawi. Sanad hadis dari Imam Muslim melalui Abu Hurairah setelah dilakukan penelitian menunjukkan seluruh periwayatannya bersifat tsiqah (‘adil dan dhabit), sanadnya bersambung, terhindar dari syudzudz dan ‘illat. Maka sanadnya adalah sahih (Afif & Khasanah 2019). Oleh yang demikian, banyak manfaat dan kelebihan bagi orang yang mengamalkan berwudhu’ dengan tatacara yang baik dan tenang dari segi kesihatan medik dan kesihatan dalaman. (Al-Khuli, 2010, hal. 32). Manfaat dan kesannya pada kesihatan akan dihuraikan pada bab yang berikutnya.

MANFAAT HIDROTERAPI WUDHU’ TERHADAP KESIHATAN

Hidroterapi wudhu’ boleh dipraktikkan oleh sesiapa sahaja dan manfaatnya dapat dilihat pada empat aspek berikut iaitu jasmani, emosi, intelek dan rohani. Namun penulisan ini hanya memfokuskan pada kesan terhadap emosi dan intelek.

EMOSI

Mengawal Stress

Berwudhu’ juga adalah satu bentuk hidroterapi yang dapat mengurangkan tekanan emosi dan juga fizikal. Nurfarah Diyana, Aida Azmi & Azwan Mat Lazim (2021) menganalisa kajian terhadap 200 responden dengan penerapan wudhu’ sebagai kaedah hidroterapi untuk menangani stres telah memberi respon positif yang mana setelah melakukan teknik berwudhu’, 90% daripada mereka telah mengalami penurunan tahap stres. Tambahan pula, ia berkait rapat dengan sedikit penurunan tekanan darah di dalam badan serta pengeluaran hormon endorfin.

Sari & Mahardyka (2017) melalui Nungki Kustantya (2013) pada penelitiannya bahawa semakin kurang tahap pengetahuan warga emas tentang kebersihan dan kesihatan, semakin tinggi risiko terkena penyakit. Apabila mereka menjaga kebersihan dan kesihatan dengan manfaat berwudhu’, mereka tidak mudah terkena stres dan tahu cara untuk mengawalinya dengan efektif.

Lebih Ceria dan Positif

Air sejuk lebih peka kepada gelombang frekuensi rendah yang dirakamkan melalui niat dalam amalan berwudhu'. Kajian yang dilakukan oleh Persatuan Mahasiswa Islam Kampus Kejuruteraan Universiti Sains Malaysia membuktikan bahawa niat ketika berwudhu' juga memainkan peranan yang sangat penting dalam membentuk aura yang baik dalam tubuh badan manusia apabila niat tersebut mengubah molekul air kepada bentuk yang lebih baik (Qurrotul Aien 2012)

Mengawal Kemarahan

(Qurrotul Aien 2012) menyatakan bahawa wudhu' boleh membantu mengawal emosi marah seseorang sebagaimana sabda Rasulullah S.A.W di dalam Riwayat Sunan Abi Daud no. 4784:

إِنَّ الْغَضَبَ مِنَ الشَّيْطَانِ وَإِنَّ الشَّيْطَانَ خُلِقَ مِنَ النَّارِ وَإِنَّمَا تُطْفَأُ النَّارُ بِالْمَاءِ فَإِذَا غَضِبَ أَحَدُكُمْ فَلْيَتَوَضَّأْ

Maksudnya: Sesungguhnya kemarahan itu datang daripada syaitan, dan syaitan itu dicipta daripada api, dan api hanya dapat dipadamkan dengan air. Maka jika salah seorang daripada kalian berasa marah, hendaklah dia berwudhu'.

Hadith ini jelas menyatakan bahawa perasaan amarah itu dapat diredakan dengan air wudhu' yang menyejukkan.

INTELEK

Mengawal Suhu Badan

Menyapu sebahagian kepala iaitu bahagian ubun-ubun dapat menyejukkan otak dan meredakan demam sekaligus mengawal dan menurunkan suhu badan. Menurut M. Kemal Irmak (2014) sistem penyejukan otak yang berfungsi seperti sistem radiator melindungi otak daripada kerosakan haba dan mengurangkan suhu di bahagian otak. Ini penting kerana otak yang terlalu panas boleh menyebabkan sawan, pengan dan kerosakan otak. Perkara ini jelas bahawa dengan berwudhu' di bahagian muka dan kepala dapat mengawal suhu di bahagian otak dan menjadikannya lebih sihat.

Sholeh Gisymar, ahli terapi alternatif, mengatakan bahawa ketika berwudhu' menjadikan aliran darah lebih lancar di kawasan anggota wudhu' kerana normalisasi suhu badan berlaku apabila suhu badan yang panas bertemu dengan air wudhu' yang sejuk. (Rosita & Siti, 2011)

Fikiran lebih fokus

Penurunan tahap fokus apabila seseorang sedang belajar dapat di atasi dengan mengambil wudhu'. Hidayati & Zarkasyi (2021) melalui penulisan Lela dkk, (2016) menyatakan bahawa wudhu' adalah salah satu cara meningkatkan konsentrasi kerana apabila seseorang berwudhu', kepala akan disapu dengan air sejuk begitu juga tangan dan kaki sehingga mempengaruhi fokus seseorang ke tahap maksimum menurut ahli neurologi.

Fikiran Tenang

Menurut Hidayati & Zarkasyi (2021) bahawa Purnamasari dkk, (2018) menyatakan wudhu' juga berpengaruh pada terapi yang luar biasa bagi ketenangan jiwa dan fikiran dan tidak hanya

untuk pembersih diri saja. Apabila bahagian kepala sejuk kerana kesan dari air wudhu' fikiran akan menjadi tenang dan seseorang itu lebih mampu untuk mendapat fikiran yang fokus.

RUMUSAN

Hidroterapi wudhu' sebagai salah satu rawatan alternatif menjadi kaedah yang boleh digunakan untuk meningkatkan kualiti kesihatan terutama kesihatan emosi dan intelek yang membawa kepada kualiti kesihatan mental yang baik. Melihat kepada situasi masyarakat dan berita di akhbar-akhbar yang menggambarkan masalah gangguan emosi dan fikiran yang tidak waras sehingga menyebabkan risiko tingkah laku keganasan (Wardani et al. 2020) maka, langkah yang proaktif perlu diambil. Oleh itu, hidroterapi wudhu' dipilih kerana kos yang murah, fleksibel dan mampu diamalkan oleh sesiapa.

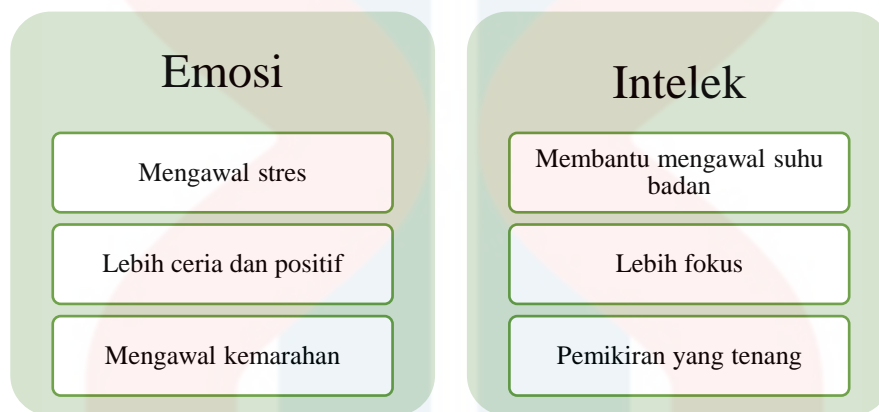

Elemen kesihatan ini juga dinyatakan oleh Pertubuhan Kesihatan Sedunia (WHO) yang mendefinisikan bahawa kesihatan merupakan kesejahteraan fizikal, mental serta sosial dan bukan hanya ketiadaan penyakit (Md Safian, 2007).

Namun apa yang penting adalah pembentukan peribadi seseorang melalui hidroterapi wudhu'. Ini kerana apabila emosi tenang, fikiran lapang dan badan berada dalam keadaan positif akan mengurangkan masalah kesihatan mental seperti stres yang akan mengakibatkan berlakunya gejala sosial dalam kalangan masyarakat.

KESIMPULAN

Hidroterapi wudhu' boleh menjadi sebagai salah satu rawatan alternatif bagi pelbagai masalah kesihatan luaran dan dalaman dengan mengamalkan tertib wudhu' yang sempurna. Keseimbangan individu dari segi keperluan emosi dan intelek begitu juga jasmani dan rohani dapat dipenuhi hanya dengan kaedah yang mudah, praktikal dan tidak melibatkan kos serta gerak kerja yang rumit.

Rasulullah S.A.W banyak menceritakan tentang kelebihan atau kesan berwudhu' pada emosi dan rohani seseorang. Namun apa yang lebih menggembirakan seorang muslim ialah, jika berwudhu' dengan tertib yang sempurna kemudian berdoa seperti yang diajarkan oleh Rasulullah S.A.W, dibukakan lapan pintu syurga. Ianya seperti mendapat tiket untuk masuk ke syurga Allah yang penuh nikmat.

Manfaat daripada sifat air dapat membantu seseorang menjaga kesihatan mental dan dalaman serta menjalani kehidupan dengan lebih tenang dan positif. Oleh yang demikian,

hidroterapi wudhu' dapat dijadikan amalan oleh orang muslim dan bukan muslim dalam usaha menjaga kebersihan dan kesihatan yang membawa kepada ketenangan dan kelapangan hati serta masyarakat yang sejahtera.

RUJUKAN

Al-Quran Karim

- Abdul Aziz, A., Mohd Sukor, N., & Ab Razak, N. (2020). *Wabak Covid-19: Pengurusan Aspek Kesihatan Mental Semasa Norma Baharu*. International Journal Of Social Science Research, 2(4), 156-174.
- Afif, M. & Khasanah, U. 2019. Urgensi Wudhu dan Relevansinya Bagi Kesehatan (Kajian Ma'anil Hadis) dalam Perspektif Imam Musbikin. *Riwayah : Jurnal Studi Hadis* 3(2): 215.
- Hidayati, E. & Zarkasyi, F. A. 2021. Pengaruh Wudhu Terhadap Peningkatan Konsentrasi Belajar Remaja. *Jurnal Keperawatan dan Kesehatan Masyarakat Cendekia Utama* 10(2): 108. doi:10.31596/jcu.v10i2.756
- Ike Rizki Yuliana Saputri. 2018. *Penanganan Perilaku Kekerasan Dengan Menggunakan Terapi Latihan Asertif Dan Hidroterapi Di Mertan Paremono Mungkid Magelang*, M. Kemal Irmak. 2014. *Medical aspects of ablution and prayer*. J Exp Integr Med 2014; 4(2):147-149. Ankara, Turki.
- Md Safian Bin Mohd Tajuddin. 2007. *Kesan Aspek Kesihatan Terhadap Produktiviti Kerja Dalam Kalangan Pensyarah Maktab Perguruan*, Universiti Sains Malaysia (USM)
- Mustofa Al-Khin, Mustofa Al-Bugho & Ali Asy-Syarbaji. 2011. *Al-Fiqh Al-Manhaji Mazhab Al-Syafie*.
- Nurfarah Diyana Bakri, Aida Azmi & Azwan Mat Lazim. 2021. *Hidroterapi: Teknik Mudah Untuk Tangani Stres*. <https://aidaazmi.com/2021/08/10/hidroterapi-teknik-mudah-untuk-tangani-stres/>
- Oan Hasanuddin. 2007. *Mukjizat Berwudhu*. Jakarta: Qultum Media, 2007, hal. 58-59
- Qurrotul Aien, F. Y. 2012. Physical And Spiritual Miracles Of Muslims' Ablution. *International Journal on Quranic Research* 2(2): 67-83.
- Rosita, Siti (2011) *Manfaat Wudhu Terhadap Kesehatan Skripsi*. STAIN Tulungagung, Indonesia
- Sari, D. K. & Mahardyka, M. W. 2017. Penerapan Wudhu Sebagai Hydro Therapy Terhadap Tingkat Stres Pada Lansia UPT PSLU Blitar Di Tulungagung. *Journal Of Nursing Practice* 1(1): 24-32. doi:10.30994/jnp.v1i1.19
- Wardani, I. K., Prabowo, A. & Brilianti, G. bara. 2020. Efektifitas Terapi Spiritual Wudhu Untuk Mengontrol Emosi Pada Pasien Resiko Perilaku Kekerasan. *Tens : Trends of Nursing Science* 1(1): 74-84. doi:10.36760/tens.v1i1.109
- Yusuf, M. A. 2018. Nikmat Allah dalam surat al-Maidah ayat enam menurut penafsiran Ahmad Musthafa al-Maraghi. Retrieved from [http://digilib.uinsby.ac.id/26920/%0Ahttp://digilib.uinsby.ac.id/26920/1/Mohamad Arifin Yusuf_E83213161.pdf](http://digilib.uinsby.ac.id/26920/%0Ahttp://digilib.uinsby.ac.id/26920/1/Mohamad%20Arifin%20Yusuf_E83213161.pdf)

Laman web/blog

- Apakah Hydrotherapy? [Http://Farahphysiotherapy.Blogspot.Com/2019/03/Apakah-Rawatan-Hydrotherapy-Rawatan-Air.Html](http://Farahphysiotherapy.Blogspot.Com/2019/03/Apakah-Rawatan-Hydrotherapy-Rawatan-Air.Html)
- <http://www.quranreading.com/blog/importance-of-wudu-significance-and-benefits-in-the-light-of-quran-and-hadith/>

<https://www.mstar.com.my/xpose/addin/2020/03/27/hindari-penyakit-ain>, Jumaat, 27 Mac 2020 9:00 AM

Irsyad Al-Hadith Siri Ke-324: Maksud ‘Dibuka Pintu Syurga’ Dalam Doa Selepas Wudhuk.
<https://Muftiwp.Gov.My/Artikel/Irsyad-Al-Hadith/2930-Irsyad-Al-Hadith-Siri-Ke-324-Maksud-Dibuka-Pintu-Syurga-Dalam-Doa-Selepas-Wudhuk>



UNIVERSITI

MALAYSIA

KELANTAN

Pengetahuan Guru dan Cabaran dalam Menintegrasikan Teknologi Maklumat dan Komunikasi (TMK) dalam Pengajaran dan Pembelajaran Pendidikan Islam: Sebuah Tinjauan Literatur

Ahmad Fikrul Amin Shanusi
Universiti Kebangsaan Malaysia (UKM)
P111213@siswa.ukm.edu.my

Mohd. Isa Hamzah
Universiti Kebangsaan Malaysia (UKM)
isa_hamzah@ukm.edu.my

ABSTRAK

Kemajuan teknologi dan revolusi industri 4.0 telah menyebabkan berlakunya proses pengintegrasian Teknologi Maklumat dan Komunikasi (TMK) dalam pengajaran dan pembelajaran Pendidikan Islam. Lantaran itu, artikel ini dijalankan adalah untuk mengetahui pengetahuan yang diperlukan oleh guru dan cabaran yang dihadapi untuk mengintegrasikan TMK dalam melaksanakan pengajaran dan pembelajaran Pendidikan Islam di sekolah. Kajian ini telah dijalankan melalui kaedah kepustakaan dengan cara mencari maklumat, data dan hujah berkaitan pendidikan teknologi dan pengintegrasian TMK yang dapat dijumpai di dalam buku, jurnal, tesis dan lain –lain. Dapatan kajian menunjukkan terdapat tiga pengetahuan utama yang harus dikuasai oleh guru iaitu pengetahuan teknologi, pengetahuan pedagogi dan pengetahuan kandungan yang disebut oleh Mishra dan Koehler di dalam Model Pengetahuan Teknologi Pedagogi Kandungan (PTPK). Tambahan itu, terdapat dua cabaran dan isu yang perlu dihadapi oleh guru dalam mengintegrasikan TMK iaitu motivasi guru dan kursus profesion keguruan. Akhir sekali, kajian ini diharap dapat dimanfaatkan kepada guru terutamanya guru Pendidikan Islam dan pengkaji akan datang dalam usaha meningkatkan pengintegrasian TMK dalam pengajaran dan pembelajaran Pendidikan Islam.

Kata Kunci: Pendidikan; Pendidikan Islam; Integrasii TMK; Cabaran; Pengajaran dan Pembelajaran

ABSTRACT

The process of integrating Information and Communication Technology (ICT) in the teaching and learning of Islamic Education has been made possible by technological developments and the 4.0 industry revolution. The purpose of this essay is to explore the information needed by instructors and the difficulties in adopting ICT in the teaching and learning of Islamic education in schools. This study used the library approach, gathering information from books, journals, theses, and other sources to obtain facts, figures, and arguments about technology education and ICT integration. The results demonstrate that there are three key knowledge areas that teachers need to be proficient in: technological knowledge, pedagogical knowledge, and content knowledge, as described by Mishra and Koehler in their Content Pedagogical Technology Knowledge Model (TPCK). In addition, teacher motivation and professional development courses for instructors are two obstacles and issues that educators must address when they integrate ICT. Lastly, in an effort to improve the integration of ICT in the teaching and learning of Islamic Education, this study is anticipated to be helpful to instructors, particularly Islamic Education teachers, and future academics

Keywords: Education; Islamic studies; TMK integration; Challenges; Teaching and learning

PENGENALAN

Revolusi Industri 4.0 dan ekonomi digital telah terjadi di seantero lapangan dan menyumbangkan penilaian kepada sektor industri, ekonomi termasuk sektor pendidikan. Hasilnya banyak aplikasi teknologi yang lebih canggih, dan berinovasi dapat dicipta. Lantaran itu, pendidikan memainkan peranan utama dalam melahirkan dan meningkatkan pemain industri pada masa akan datang dengan membekalkan pengetahuan, kemahiran dan nilai kepada para pelajar. Kementerian Pendidikan Malaysia (KPM) berpandangan bahawa untuk membentuk Malaysia menjadi sebuah wilayah berperolehan tinggi, Teknologi Maklumat dan Komunikasi (TMK) hendaklah diaplikasi dalam pengajaran dan pembelajaran serta dalam pentadbiran dan pengurusan sekolah (Kementerian Pendidikan Malaysia, 2012). Selain itu, berdasarkan anjakan ketujuh Pelan Pembangunan Pendidikan Malaysia 2013 – 2025 (PPPM 2013–2035) terdapat beberapa transformasi dan pendekatan kepada penggunaan TMK dalam pendidikan seperti pengintegrasian TMK sepenuhnya untuk semua mata pelajaran, menyediakan prasarana dan bahan bantu di semua sekolah serta menggalakkan pembelajaran tanpa sempadan dan pengaplikasian Sains, Teknologi, Kejuruteraan dan Matematik (STEM) (Kementerian Pendidikan Malaysia, 2013).

Matlamat Pendidikan Islam adalah bertujuan untuk melahirkan pelajar yang seimbang perkembangannya. Ledakan TMK dan dunia komunikasi tanpa sempadan memerlukan pelajar hari ini menguasai bidang teknologi agar dapat digunakan di jalan yang betul dan tidak menyimpang dengan Al – Quran dan Al- Hadis seperti saranan Khalifah Saidina Ali RA pernah menyarankan supaya didiklah anak – anakmu sesuai dengan zamannya. Nikmat ilmu pengetahuan dan teknologi merupakan nikmat yang paling agung yang dikurniakan kepada umat Nabi Muhammad SAW kerana dapat memberikan kemudahan dan kesejahteraan dalam kehidupan (Jasmi & Tamuri, 2007). Justeru itu, guru perlulah sedar akan fungsi teknologi dengan memastikan pengintegrasian TMK secara islamik dengan tepat dan terancang.

Pada tahun 2011, Kurikulum Standard Sekolah Rendah (KSSR) mengkategorikan TMK sebagai elemen merentas kurikulum bersama – sama dengan elemen kreativiti dan inovatif, keusahawanan. Namun begitu mulai tahun 2017 TMK dilaksanakan sebagai modul tambahan yang menerapkan Kemahiran Pemikiran Komputasional (KPK) dan akan diajar secara merentas kurikulum mengikut kesesuaian tajuk. Mata pelajaran Pendidikan Islam juga terlibat dengan modul kemahiran asas TMK yang memfokuskan penguasaan dasar yang perlu diterapkan dan modul aplikasi yang mengandungi (KPK). Sebelum melaksanakan modul ini, guru perlulah membuat pertimbangan dari aspek latihan, waktu pelaksanaan, peranan guru, pelaksanaan pengajaran dan pembelajaran, dan peruntukan per kapita geran (Kementerian Pendidikan Malaysia, 2016). Oleh itu, guru sepatutnya mempersiapkan dengan kepandaian dan kemahiran dalam melaksanakannya. Koehler & Mishra, 2008 mencadangkan Model Pengetahuan Teknologi Pedagogi Kandungan (PTPK) sebagai kaedah dan strategi pengajaran TMK. Guru yang cemerlang adalah guru yang tahu apa yang ingin disampaikan kepada pelajar, bagaimana pelajaran dapat disampaikan dan bahan apa yang boleh memudahkan untuk pelajar faham.

Pengetahuan adalah epistemologi yang bermaksud apa yang diketahui dan bagaimana mengetahuinya (Chee et al., 2018). Selain itu pengetahuan juga disebut sebagai maklumat atau kesedaran yang diperolehi melalui menuntut ilmu atau pengalaman hidup. Pengetahuan teknologi bermaksud kaedah atau mengintegrasikan bahan teknologi yang terdapat di sekeliling ke dalam pengajaran. Pengetahuan pedagogi pula ialah perancangan, strategi, pengurusan dan pengendalian kelas semasa melaksanakan pengajaran dan pembelajaran. Seterusnya

pengetahuan kandungan pula merujuk kepada filosofi, persepsi atau kepercayaan sesuatu penataran atau mata pelajaran. Pendekatan ini paling pantas untuk dilaksanakan dalam pengajaran dan pembelajaran yang memerlukan pengintegrasian TMK (Aguinaldo, 2017). Oleh itu, guru harus diberikan kesedaran mengenai kepentingan TMK dan cara pelaksanaan ke dalam pengajaran dan pembelajar agar keyakinan guru dan pelajar dapat dipertingkatkan lagi.

PERNYATAAN MASALAH

Melalui penyelidikan kajian terdahulu, pengkaji mendapati terdapat banyak masalah dan kekangan kepada guru Pendidikan Islam terutamanya melibatkan penggunaan teknologi. Hal ini kerana guru – guru tidak sensitif dengan pemanfaatan aplikasi teknologi dan penggunaannya dalam pengajaran dan pembelajaran. Mohd Nawi et al., (2020) telah menjalankan kajian terhadap guru Pendidikan Islam dan mendapati penggunaan teknologi dalam pelbagai media hanya memenuhi tahap minimum (M : 3.03, SP : 0.940). Selain itu, tahap penggunaan TMK dalam kategori pensyarah Pendidikan Islam di Politeknik Zon Selatan berada pada tahap tinggi tetapi min yang terendah (Zakaria et al., 2017). Hal ini demikian kerana terdapat beberapa komponen yang memberi impak kepada penggunaan teknologi seperti pengalaman mengajar, pengetahuan dan persediaan. Contohnya terdapat guru Pendidikan Islam yang sudah mendidik lebih daripada 11 tahun memiliki tahap pelaksanaan yang rendah daripada guru yang kurang daripada 10 tahun (Mohd Nawi et al, 2020). Analisa Lubis et al, (2017) mendapati kesediaan guru Pendidikan Islam di Selangor dalam mengaplikasi multimedia adalah sederhana tinggi (M: 3.92 , SP: 0.43). Selain itu, terdapat juga elemen lain seperti kekurangan masa, kekurangan infrastruktur ICT, kekurangan tenaga mahir ICT dan kelembapan internet menyebabkan guru berasa takut untuk menggunakan perisian teknologi (Vinathan, 2016). Pengajaran berbantuan teknologi merupakan cara yang sistematik dalam menyediakan pelbagai konsep, teknik strategi dan mudah dalam Pendidikan Islam.

Seterusnya ialah guru Pendidikan Islam gagal untuk melaksanakan pengintegrasian pengajaran di dalam kelas disebabkan oleh kegagalan dalam komunikasi, pemilihan teknik dan strategi pengajaran dan tidak cekap mengurus kelas (Abdul Wahab et al, 2017). Hal ini membuatkan murid – murid berasa bosang dan hilang minat kerana pengajaran yang dilaksanakan tidak menarik dan lebih kepada pengajaran satu hala. Guru yang gagal memilih pendekatan yang sesuai akan menyebabkan kemerosotan minat murid terhadap pembelajaran (Yunos, 2015). Pendekatan yang sering diaplikasi untuk meningkatkan keberkesanan dan menerapkan suasana pengajaran yang lebih menarik adalah melalui pengintegrasian kaedah multimedia dengan menggabungkan skrip, nada bunyi, suara dan lain – lain (Jasmi & Tamuri, 2007). Hal ini kerana terdapat interaksi antara kemahiran belajar dengan akademik (Najib & Ahmad, 2008). Oleh itu guru haruslah merancang untuk memenuhi semua keperluan kemahiran belajar murid dengan menggunakan teknologi yang dapat membantu menyediakan bahan pengajaran dalam masa yang singkat.

Seterusnya adalah bebanan kerja dan persekitaran yang dituju telah mempengaruhi tugas hakiki iaitu mengajar. Hal ini mengakibatkan guru berasa tertekan sehingga mempengaruhi emosi, proses berfikir, dan sentiasa berada di dalam kegelishan dan ketakutan (Muhbar & Rochmawati, 2017). Menurut Bekas Ketua Pengarah Pelajaran, Tan Sri Alimuddin Mohd. Dom punca mengapa guru semakin tawar untuk mengajar dan memilih untuk bersara awal adalah disebabkan oleh pelbagai tugas bukan hakiki yang perlu dilakukan selain mengajar (Zin, 2022). Hal ini kerana bebanan yang diberikan sama ada akademik atau tidak akademik akan mempengaruhi motivasi dan akhirnya mempengaruhi keefisienan kerja guru (Antin & Kiflee, 2018). Tambahan pula kekurangan guru menyebabkan guru bukan opsyen

dipaksa untuk mengajar. Ini akan menjejaskan kualiti mutu pengajaran Pendidikan Islam sendiri disebabkan oleh guru bukan opsyen yang kurang pengetahuan mengenai pedagogi dan kandungan pengajaran dipaksa untuk mengajar.

Kemunculan gelombang pandemik Covid 19 telah meninggalkan isyarat negatif kepada kecemerlangan pelajar terutama dalam Pendidikan Islam. Hal ini disebabkan oleh pelbagai halangan yang harus ditempuh oleh guru dan pelajar seperti kekurangan peranti, liputan internet yang rendah, dan kekurangan kewangan. Berdasarkan Analisa SPM 2019, terdapat penurunan kepada pelajar yang mendapat A dalam mata pelajaran Pendidikan Islam iaitu 1.9 peratus dan peningkatan kepada pelajar yang gagal 0.4 peratus (Kementerian Pelajaran Malaysia, 2020). Manakala SPM 2020 pula, pelajar yang gagal dalam SPM bagi mata pelajaran Pendidikan Islam iaitu 11.9 peratus iaitu tiada perubahan dengan SPM 2019. Selain itu, Pendidikan Islam antara mata pelajaran paling ramai gagal setelah Bahasa Inggeris, Matematik, dan Pendidikan Moral (Kementerian Pendidikan Malaysia, 2021). Oleh itu, satu kajian telah dilakukan oleh Dalila & Yunus (2021) mengenai kesan pandemik Covid 19 terhadap tahap pencapaian akademik pelajar dan mendapati kaedah pengajaran dan pembelajaran guru mempengaruhi tahap akademik pelajar. Manakala kemudahan akses internet, dorongan ibu bapa dan motivasi daripada menggunakan pendekatan teknologi telah memberi kesan kepada tahap akademik murid di dalam kelas atas talian. Justeru, pendekatan berunsurkan teknologi dapat meringankan pelajar dan guru untuk menjalankan pembelajaran semasa pandemik.

Kesimpulannya isu pengintegrasian TMK adalah sangat penting ketika ini. Namun begitu pengkaji mendapati sekitar tahun 2017 hingga 2022 kurangnya kajian mengenai pengetahuan teknologi dilakukan dalam aspek pengajaran Pendidikan Islam di Malaysia. Sehingga kini dapatan kajian yang dijalankan adalah kurang jelas terutamanya pengetahuan yang terdapat pada guru Pendidikan Islam itu sendiri. Justeru itu, pengkaji cuba untuk memperluaskan skop pengetahuan guru Pendidikan Islam kepada pengetahuan teknologi, pengetahuan pedagogi dan pengetahuan kandungan seperti yang dicadangkan oleh Model PTPK tetapi berorientasikan Pendidikan Islam. Kebanyakan kajian yang telah dijalankan dalam negara meliputi mata pelajaran Pendidikan Khas bermasalah pendengaran (Peng & Daud, 2017), Reka Bentuk Teknologi (Masingan & Shari, 2019) dan Bahasa Arab (Rusdi & Ismail, 2018). Seterusnya, kebanyakan kajian yang dilakukan adalah sebelum negara mengalami pandemik Covid 19. Semasa pandemik, pengajaran dan pembelajaran telah dijalankan dalam talian dan guru telah didedahkan dengan pelbagai kursus, seminar, dan webinar dalam mengintegrasikan teknologi dalam pengajaran. Lantaran itu, satu kajian harus dilakukan bagi mengetahui pengetahuan guru dan cabaran yang dihadapi dalam mengintegrasikan TMK selepas Covid 19.

KAJIAN LITERATUR

Pengetahuan guru

Islam meletakkan pengetahuan sebagai asas dan kedudukan yang tinggi dalam masyarakat sehingga mewajibkan umatnya untuk mencari ilmu pengetahuan. Buktinya boleh dilihat dengan jelas berdasarkan ayat mula-mula yang diberikan kepada Nabi Muhammad SAW iaitu “bacalah” daripada surah al-Alaq Justeru itu, Setiap guru harus mengetahui pengetahuan mengenai cara memilih ilmu dan kaedah pengajaran yang betul. Selain itu, mempunyai kefahaman secara terperinci terutamanya dalam mata pelajaran yang diajar serta memiliki kebijaksanaan dalam menyampaikan pengajaran yang lebih berkesan (Ishak, 1989). Seterusnya

mempunyai pengetahuan dalam kemahiran komunikasi yang berkesan iaitu komunikasi lisan dan bukan lisan (Kamarul Azmi Jasmi & Ab. Halim Tamuri, 2007)

Parkay & Stanford (2010) menyenaraikan tiga jenis pengetahuan yang perlu diketahui iaitu pengetahuan mata pelajaran, pengetahuan teori dan penyelidikan pendidikan. Angeli & Valanides (2005) memperkenalkan ICT – TPACK dengan menggariskan lima kategori pengetahuan iaitu pengetahuan kandungan, pengetahuan pedagogi, pengetahuan pelajar, pengetahuan ICT dan pengetahuan konteks. Manakala, Yeh et al, (2014) memperkenalkan lapan dimensi pengetahuan yang wajib dikuasai oleh guru iaitu pengetahuan kandungan, pengetahuan mata pelajaran, pengetahuan reka bentuk pengajaran, pengetahuan penilaian, pengetahuan tentang pelajar, pengetahuan pedagogi, pengetahuan praktikal dan pelaksanaan pengajaran, dan pengetahuan kurikulum. Pengetahuan - pengetahuan ini berkolaborasi satu sama lain bagi meneguhkan pengajaran supaya dapat dilaksanakan dengan efektif dan meraih objektif.

Proses Pengajaran

Pengajaran merupakan proses yang dilakukan untuk menyampaikan dan menyebarkan ilmu pengetahuan melalui aktiviti perancangan, pengelolaan, penyampaian, bimbingan dan penilaian (Sam et al, 2013). Pengajaran terdiri daripada guru sebagai pemain utama, kurikulum, murid, tempat dan masa (Keow, 2012). Antara komponen yang perlu diketahui dalam pengajaran ialah orientasi pengajaran, model pengajaran, pendekatan pengajaran, strategi pengajaran, kemahiran mengajar, teknik mengajar dan aktiviti pembelajaran. (Jit & Ngen, 2020). Sekiranya guru memahami dan mengimplementasikannya dalam pengajaran, prestasi murid – murid dalam akademik akan meningkat kerana keperluan dan kecerdasan mereka dipenuhi.

Kajian Iywon & Nasri (2020) mengenai tingkatan kesediaan dan sokongan bagi manifestasi pendekatan TMK menunjukkan terdapat perbezaan min antara jantina perempuan dan lelaki. Seterusnya, tahap sokongan yang diterima oleh guru bandar juga lebih tinggi daripada skor luar bandar. Kajian penggabungan teknologi dalam kesusasteraan Melayu oleh Omar (2016) mendapati kaedah pengajaran yang diaplikasi oleh guru semasa latihan mengajar memberi kesan yang positif. Kesimpulannya, penggunaan TMK dalam pendekatan, strategi dan kaedah pengajaran telah meningkatkan minat pelajar kepada pembelajaran. Hal ini kerana tahap sokongan dan kesediaan perlu dalam memastikan kelangsungan pengajaran

Proses Pembelajaran

Pembelajaran bermaksud perubahan tingkah laku iaitu daripada tidak tahu kepada tahu disebabkan oleh amalan atau aktiviti dan berkekalan merentasi masa (Keow, 2012). Dalam konteks pendidikan, pembelajaran bermaksud modifikasi perbuatan disebabkan oleh ilmu, kemahiran dan nilai yang diperolehi melalui pengajaran. Manakala kemahiran belajar pula bermaksud keupayaan, kebolehan dan kecekapan seseorang pelajar untuk mendapatkan ilmu pengetahuan dan berlakunya perubahan tingkah laku (Wah et al, 2019). Kemahiran belajar sangat penting kerana murid dapat mengenali kelemahan dan kekuatan diri sendiri. Terdapat sembilan komponen yang harus dikuasai oleh setiap pelajar iaitu pengelolaan pembelajaran, pengendalian masa, kecenderungan belajar, cara membaca, berfikir, penglibatan aktif di dalam kelas, mengumpulkan nota, pemikiran sendiri dan kemahiran abad ke 21.

Kajian Wahab et al, (2020) kepada 102 orang pelajar SMK harian biasa di Terengganu menemui tiada perbezaan terhadap penggunaan ICT sebagai medium pembelajaran berdasarkan lokasi sekolah tetapi mempunyai hubungan kefahaman tentang IR 4.0 terhadap penggunaan ICT. Ishak & Yamin (2019) mendapati literasi pelajar agak tinggi lebih- lebih lagi

berkaitan pemakaian perisian aplikasi yang mempunyai pengetahuan teknikal seperti mengoperasikan dan mengendalikan peranti ICT.

Model Pengetahuan Teknologi Kandungan (PTPK)

Revolusi industri 4.0 dan internet berkelajuan tinggi memerlukan guru dan murid menggunakan teknologi sebagai medium pembelajaran. Tambahan itu, pendidikan Abad ke 21 merupakan gabungan daripada tiga gagasan utama iaitu teknologi, pedagogi dan kandungan (Nazir et al, 2017). Model yang diadaptasi oleh Mishra & Koehler (2008) menjadi sangat popular dalam dunia pendidikan apabila elemen ini memfokuskan kemahiran penerapan teknologi dengan pengetahuan teknologi (PT), Pengetahuan Pedagogi (PP) dan Pengetahuan Kandungan (PK). Hasil daripada interaksi tiga elemen utama, maka muncul lagi empat elemen iaitu Pengetahuan Pedagogi Kandungan (PPK), Pengetahuan Teknologi Kandungan (PTK), pengetahuan Teknologi Pedagogi (PTP) dan Pengetahuan Teknologi Pendidikan Kandungan (PTPK).

Model PTPK telah membuktikan impak yang positif dan membantu guru untuk mengintegrasikan teknologi dalam pendidikan. Para pelajar mulai menggemari teknologi kerana pengajaran yang dilakukan oleh guru bersesuaian dengan kemahiran dan kecerdasan pelajar (Guat, 2017). Selain itu, PTPK juga dapat memudahkan guru dalam menyediakan bahan pengajaran serta menjimatkan kos pembuatannya (Hilmi et al, 2020). Konsep ini adalah sangat relevan dan mengikut arus semasa (Rusdi & Ismail, 2018). Oleh itu, guru seharusnya mengintegrasikan teknologi dalam pengajaran dengan dipandu oleh pengetahuan pengajaran dan pedagogi

TUJUAN KAJIAN

Tujuan artikel ini dijalankan adalah untuk mengetahui pengetahuan yang diperlukan serta cabaran yang dihadapi oleh guru untuk mengintegrasikan TMK dalam melaksanakan pengajaran dan pembelajaran Pendidikan Islam di sekolah

OBJEKTIF KAJIAN

1. Mengenalpasti pengetahuan yang diperlukan oleh guru untuk mengintegrasikan TMK dalam melaksanakan pengajaran dan pembelajaran Pendidikan Islam,
2. Mengetahui cabaran pelaksanaan pengajaran dan pembelajaran Pendidikan Islam menggunakan TMK

PERSOALAN KAJIAN

1. Apakah pengetahuan yang diperlukan oleh guru untuk mengintegrasikan TMK dalam melaksanakan pengajaran dan pembelajaran Pendidikan Islam
2. Apakah cabaran pelaksanaan pengajaran dan pembelajaran Pendidikan Islam menggunakan TMK

METODOLOGI

Kajian ini telah menggunakan kaedah penyelidikan kepustakaan yang bertujuan untuk mendapatkan data dan dapatan kajian. Pengkaji telah mendapatkan maklumat melalui pembacaan buku, artikel, tesis dan prosiding. Tambahan itu, pengkaji juga telah mencari jurnal – jurnal dalam talian yang boleh didapati dengan melayari engine carian utama seperti Google Scholar, ResearchGate, dan Jurnal Dunia Pendidikan. Kata kunci yang digunakan dalam mencari maklumat adalah “pengetahuan teknologi” “pengetahuan pedagogi”, “pengetahuan

kandungan”, “pengetahuan teknologi pedagogi kandungan”. “teknologi pendidikan”, “teknologi maklumat dan komunikasi “ dan akhir sekali “pengintegrasian teknologi dalam Pendidikan Islam’. Semua maklumat yang diperolehi akan dinilai terlebih dahulu dari sudut kesesuaian dan keaslian kajian sebelum digunakan oleh pengkaji untuk menulis dalam artikel ini. Seterusnya, bahan dan sumber ini akan dijadikan sumber rujukan utama dalam penghasilan penulisan ilmiah yang bermutu dan mengikut piawaian standard yang telah ditetapkan dalam penulisan akademik.

DAPATAN DAN PERBINCANGAN

Pengetahuan yang diperlukan oleh guru untuk mengintegrasikan TMK dalam melaksanakan pengajaran dan pembelajaran Pendidikan Islam

Sebelum guru melaksanakan pengajaran dan pembelajaran Pendidikan Islam dengan mengintegrasikan TMK, terdapat tiga pengetahuan yang harus dikuasai iaitu pengetahuan teknologi, pengetahuan kandungan dan pengetahuan pedagogi

Pengetahuan Teknologi (PT)

Pengetahuan teknologi bermaksud pengetahuan menggunakan teknologi dalam aspek peralatan, perkakasan, perisian dan juga mempunyai kemahiran menggunakannya sehingga mampu untuk membantu guru dalam proses pengajaran. Pada masa yang sama mampu untuk mengendalikan pengoperasian sistem serta mampu menggunakan perisian asas (Peng & Daud, 2017). Hal ini melibatkan penggunaan teknologi yang mudah hingga ke teknologi digital (Guat, 2017). Guru yang berpengetahuan teknologi ialah guru yang tahu cara untuk mengemudikan komputer, projektor dan perisian yang serasi (Law & Mahmud, 2021). Contohnya internet, kamera, telefon bimbit, komputer dan perisian seperti *Microsoft Word, Slide, Excel* dan lain – lain lagi. Pengetahuan ini penting bagi guru Pendidikan Islam untuk mengenal pasti teknologi yang sesuai dengan topik pelajaran dan kekangan yang akan dihadapi semasa pengajaran.

Seterusnya, guru Pendidikan Islam harus menguasai kemahiran asas menggunakan media elektronik yang berasaskan komputer. Menggunakan aplikasi perisian komputer dengan betul merupakan salah satu daripada kemahiran generik. Contoh perisian komputer yang harus dikuasai oleh guru Pendidikan Islam ialah perisian utiliti, perisian hampanan elektronik, perisian pangkalan data, dan perisian pemprosesan perkataan. Perisian-perisian ini boleh didapati di *Google* secara dalam talian seperti *Docs, Sheets, Slide, Forms, Classroom* dan pihak *Microsoft* juga telah menyediakan beberapa perisian *Microsoft Office* yang boleh dimuat turun secara percuma dan tanpa menggunakan internet seperti *Word, Excell, dan Power Point*. Perisian ini dapat membantu guru Pendidikan Islam untuk mempersembahkan bahan pengajaran dan memudahkan untuk menganalisis penilaian pelajar.

Berdasarkan kajian Kaviza (2021) mengenai penggunaan aplikasi *Google Classroom (GC)* dalam mata pelajaran menunjukkan penggunaan GC adalah sangat berkesan dalam meningkatkan pembelajaran murid. WhatsApp dan Telegram juga dianggap sebagai pelengkap kepada penggunaan portal e-pembelajaran dan pengajaran bersemuka (Lamsah 2017). Hasilnya menyatakan engajaran melalui aplikasi GC, Whatsapp, dan Telegram berdaya untuk memajukan kemampuan pelajar. Oleh itu guru Pendidikan Islam boleh menggunakan aplikasi whatsapp, Telegram, GC dan lain – lain lagi sebagai medium pembelajaran baharu yang lebih mudah dan fleksibel kepada pelajar dan guru. Selain itu dapat mewujudkan satu komuniti yang mampu untuk berkomunikasi antara satu sama lain dalam mencapai objektif pembelajaran.

Pengetahuan Pedagogi.

Pengetahuan pedagogi pula merujuk kepada metode pengajaran yang dirancang oleh guru melalui pendekatan, teknik dan kaedah yang sesuai dengan objektif pembelajaran. Selain itu pengetahuan ini juga merangkumi cara pembelajaran murid, pengurusan kelas, penilaian terhadap kemahiran, nilai pelajar (Peng & Daud, 2017) pengelolaan kelas, pentaksiran tugasan, Rancangan Pengajaran Harian (RPH) dan aktiviti pengajaran di dalam kelas (Law & Mahmud, 2021). Oleh itu, guru Pendidikan Islam haruslah mahir dengan teori dan model pedagogi agar pengajaran yang lebih bermakna dan memenuhi kecenderungan pelajar itu sendiri.

Orientasi pengajaran bermaksud tingkah laku yang memberi penekanan kepada sesuatu amalan atau pemahaman seorang guru terhadap proses pembelajaran (Jit & Ngen, 2020). Seterusnya guru Pendidikan Islam harus menguasai model pengajaran bermaksud persekitaran pembelajaran yang boleh dijadikan rujukan kepada guru dalam merancang kurikulum, menyediakan bahan pengajaran dan lain – lain (Keow, 2012) Pendekatan pengajaran pula bermaksud cara mendekati sesuatu iaitu bagaimana pelajaran diajar kepada murid sama ada secara induktif, deduktif, integratif, elektik atau tematik (Sam et al, 2013).

Strategi pengajaran pula ialah kaedah atau alatan mengajar yang digunakan bagi mencapai objektif pembelajaran samada melalui teknik atau bahan mengajar seperti strategi penyoalan, strategi mengimbas kembali, strategi maklum balas dan lain – lain (Jit & Ngen, 2020). Kemudian, teknik dan kaedah mengajar ialah cara guru menjalankan langkah dalam pengajaran seperti teknik tunjuk cara, bersoal jawab, menghafal, bersyarah, bercerita dan tunjuk cara (Salleh, 2011) Kemahiran mengajar pula merujuk kepada kompetensi guru dalam menyaring, mengorganisasikan, dan mengelola strategi dan merealisasikan pembelajaran yang menarik. (Jit & Ngen, 2020).

Seterusnya, guru Pendidikan Islam juga harus menjalankan aktiviti pengajaran yang boleh dilakukan sama ada secara mikro atau makro. Pengajaran mikro melibatkan pengajaran dalam masa yang singkat dengan hanya melibatkan lima proses iaitu memilih topik, merancang, memerhati, mengajar dan perbincangan. Manakala pengajaran makro pula melibatkan pendahuluan, set induksi, perkembangan, penilaian dan penutup. (Salleh, 2011).

Selari dengan kemajuan teknologi, maka tuntutan kepada transformasi kurikulum dilakukan dengan memperkenalkan pembelajaran abad ke 21. Terdapat empat kemahiran dalam pembelajaran abad ke 21 iaitu kolaboratif, pemikiran kreatif, pemikiran kritis dan komunikasi (Faridah Nasir et al, 2017). Kolaboratif bermaksud sekumpulan pelajar bekerjasama dalam merancang, melaksanakan dan menilai sesuatu tugasan. Pemikiran kritis pula pelajar dapat membezakan, memutuskan dan menyoal sama ada sesuatu peristiwa itu benar atau salah. Seterusnya pemikiran kritis dapat membantu pelajar untuk mencipta, menghasilkan dan memperkembangkan sesuatu idea yang baharu dan asli dan akhir sekali komunikasi iaitu pelajar mampu untuk menyatakan maklumat yang ingin disampaikan dengan jelas dan mudah difahami.

Kesimpulannya guru Pendidikan Islam harus mengetahui pengetahuan pedagogi bagi memastikan objektif pembelajaran tercapat. Pengetahuan pedagogi dapat dirumuskan kepada orientasi, model, pendekatan, teknik, kaedah, kemahiran, aktiviti pengajaran, pembelajaran abad ke 21 dan Kemahiran Berfikir Aras Tinggi (KBAT).

Pengetahuan Kandungan

Pengetahuan ini bermaksud kandungan yang ingin diajar kepada murid berdasarkan Standard Kandungan, Standard Pembelajaran dan Standard Penilaian yang terdapat di dalam Dokumen Standard Kurikulum dan Pentaksiran (DSKP). Selain itu, pengetahuan ini merujuk kepada pengetahuan isi kandungan pelajaran yang dipelajari atau diajar (Law.& Mahmud, 2021, Peng

& Daud, 2017). Tambahan itu, merangkumi kandungan seperti konsep, teori, rangka kerja, keterangan dan bukti serta amalan-amalan yang diperlukan ke arah membangunkan pengetahuan (Guat, 2017). Bagi mata pelajaran Pendidikan Islam sekolah rendah merangkumi beberapa bidang seperti al-Quran, akidah, ibdah, sirah dan akhlak.

Kurikulum Standard Sekolah Rendah (KSSR) Pendidikan Islam telah diperkenalkan pada tahun 2011 dan telah disemak semula pada tahun 2017. Penekanan diberikan kepada aspek ilmu, amali, amalan, penghayatan dan pembudayaan dalam kehidupan. Melalui mata pelajaran ini murid dibekalkan dengan pengetahuan asas tentang al-Quran, hadis, akidah, ibadah, sirah, adab dan jawi (Kementerian Pendidikan Malaysia, 2018). Matlamat KSSR Pendidikan Islam adalah untuk melahirkan modal insan dan khalifah Allah SWT yang berpengetahuan, beriman, bertaqwa, beramal soleh, bekeperibadian mulia dan berketerampilan berdasarkan sumber utama iaitu al-Quran dan al-Sunnah. Seterusnya dapat menyumbang ke arah mempertingkatkan tamadun bangsa, masyarakat dan negara serta kesejahteraan dunia dan akhirat.

Cabaran pelaksanaan pengajaran dan pembelajaran Pendidikan Islam menggunakan TMK

Terdapat pelbagai cabaran dan isu yang dihadapi oleh guru Pendidikan Islam dalam mengintegrasikan TMK dalam pengajaran dan pembelajaran. Antara cabaran yang dihadapi iaitu efikasi sendiri iaitu keyakinan guru, pembangunan profesionalisme keguruan, pengalaman mengajar, sokongan sekolah (Law & Mahmud, 2021) perspektif masyarakat, amalan guru Pendidikan Islam, tahap kesediaan ibu bapa dan murid, penguasaan ilmu dan kemahiran, beban tugas guru, cabaran penerapan nilai murni (Bashah & Zulkifli, 2022).

Motivasi Guru

Cabaran yang dihadapi oleh guru Pendidikan Islam dalam mengintegrasikan TMK dalam pengajaran dan pembelajaran ialah motivasi sendiri atau keyakinan. Hal ini demikian kerana kecanggihan teknologi, kurangnya pendedahan sejak awal, kurangnya kemudahan prasarana, dan liputan internet yang rendah telah menyebabkan guru berada di dalam tekanan (Marhaton, 2021). Lantaran itu, guru Pendidikan Islam ini telah memilih untuk menggunakan pendekatan tradisional iaitu berpusatkan pelajar dan menggunakan bahan bantu mengajar yang mudah seperti pen dan papan putih semasa mengajar. Kemunculan Covid 19 semakin menambahkan lagi bebanan kepada sesetengah guru Pendidikan Islam apabila terpaksa melaksanakan pengajaran dan pembelajaran dalam talian.

Seseorang guru akan bertingkah laku berdasarkan kepada kepercayaan dan motivasi yang terdapat disekelilingnya. Motivasi adalah satu tenaga yang mendorong seseorang untuk melakukan sesuatu bagi mencapai matlamat (Sam at al, 2013). Guru Pendidikan Islam yang mempunyai motivasi akan berasa seronok dalam menyampaikan pengetahuan dan tidak merasa terbeban dan letih apabila menghadapi cabaran dan dugaan dalam kehidupan. Terdapat dua jenis motivasi iaitu motivasi instrinsik dan motivasi ekstrinsik yang boleh digunakan dalam kehidupan seorang guru Pendidikan Islam.

Motivasi intrinsik adalah minat yang terdapat dalam diri seseorang guru Pendidikan Islam untuk melakukan sesuatu tanpa mengambil kira ganjarannya. Hal ini demikian kerana motivasi ini menggalakkan kepada kebebasan mengajar berasaskan kepada minat dan keseronokan. Contohnya guru Pendidikan Islam diberikan kebebasan untuk memilih mana – mana pendekatan, strategi atau kaedah yang sesuai dengan murid tanpa ada paksaan daripada orang lain. Selain itu, guru Pendidikan Islam diberikan autonomi untuk menilai tahap pencapaian pelajar mereka dengan menggunakan instrument sendiri kerana guru yang paling

mengetahui pelajarnya. Kesannya guru Pendidikan Islam akan bersemangat untuk melakukan pengajaran kerana tiada paksaan daripada orang luar.

Seterusnya motivasi ekstrinsik ialah galakkan atau tarikan daripada persekitaran. (Sam at al, 2013). Ganjaran harus diberikan kepada guru Pendidikan Islam yang berjaya dalam melahirkan keberhasilan murid sama ada pujian, hadiah, wang saguhati, kenaikan pangkat atau kenaikan gaji. Namun begitu, motivasi ini memang dapat memberikan semangat dan motivasi tetapi prestasi guru Pendidikan Islam akan merosot jika tidak diberikan ganjaran dan pujian terhadap amalan cemerlang. Oleh itu, peneguhan harus diberikan selalu dengan memfokuskan kepada konsep ikhlas dalam melakukan aktiviti seharian.

Kesimpulannya kajian yang dilakukan Ramli & Zulkifli (2022) mendapati tahap motivasi guru Pendidikan Islam terhadap pengajaran dan pembelajaran atas talian berada pada tahap yang tinggi. Oleh itu bagi memastikan kelangsungan penggunaan TMK dalam pengajaran dan pembelajaran, motivasi intrinsik dan ekstrinsik harus dijadikan sebagai satu amalan sehingga membentuk kebiasaan dalam diri guru Pendidikan Islam.

Pembangunan Profesion Keguruan.

Cabaran seterusnya ialah kurangnya program sokongan dan pemantauan berterusan kepada guru – guru Pendidikan Islam. Kajian yang dilakukan oleh Aslan & Zhu (2016) mendapati guru sudah mempunyai kemahiran TMK seperti mengaplikasikan *Microsoft Power Point* dan projektor tetapi penggunaannya dalam mengintegrasikan pengajaran adalah sangat kurang dan jarang. Selain itu, kurangnya kursus pembangunan dan pendedahan awal TMK akan memaksa guru untuk menggunakan pengajaran tradisional dan berpusatkan guru.

Dalam meningkatkan profesional keguruan, program pementoran telah diperkenalkan dalam program transformasi sekolah 2025 (TS 25) Marjonet & Hajar (2020) Program pementoran bagi guru-guru baharu adalah amat penting dalam peningkatan profesionalisme keguruan. Elemen yang difokuskan adalah pengajaran dan pembelajaran, kokurikulum, pengurusan hal ehwal pelajar, pengurusan kewangan serta lain-lain pengurusan umum. Hal ini penting bagi membolehkan guru yang mempunyai pengalaman dan kepakaran dalam pengintegrasian TMK untuk membimbing dan memantau pelaksanaan TMK dalam kalangan guru baharu. Program pementoran sangat penting dijalankan kerana dapat meningkatkan tahap ilmu dan tahap kemahiran warga sekolah, meningkatkan komunikasi berkesan dan meningkatkan kecemerlangan institusi dalam melahirkan warga yang lebih berkemahiran dengan prestasi kerja yang cemerlang.

Selain itu, terdapat juga program *Professional Learning Communities (PLC)* dalam latihan dalam perkhidmatan. PLC diwujudkan bagi memantapkan amalan instruksional, tingkatan pembelajaran murid dan hasil positif kepada murid. Kursus, bangkel, dan perkongsian maklumat melalui jalinan dan jaringan boleh diadakan bagi meningkatkan pengintegrasian TMK dalam pengajaran. Selain itu, PLC juga boleh dilakukan dengan sesiapa sahaja tanpa batasan bilangan ahli asalkan objektinya jelas dan dapat menyelesaikan masalah. Aishah & Jamian (2016) PLC diadakan bagi membantu guru-guru memberi nilai tambah kepada cara mengajar demi meningkatkan pencapaian pelajar dalam akademik. Pelaksanaan PLC secara berkala dapat membantu guru belajar cara mengajar melalui aktiviti yang sesuai. Justeru itu, guru Pendidikan Islam boleh menggunakan platform PLC sebagai medium untuk penyampaian maklumat mengenai TMK.

Seterusnya pembimbing pakar atau *School Improvement Specialist Coach (SISC+)* boleh bersama – sama dengan pihak PPD untuk merangka hala tuju dan latihan yang sesuai. Said et al, (2016) menunjukkan bahawa program SSIC+ ini amat baik dan relevan untuk membantu guru-guru melaksanakan P&P yang berkualiti. Peningkatan kualiti pengajaran guru telah berjaya dimantapkan walaupun tidak mencapai sepenuhnya menerusi proses bimbingan

dan pementoran yang telah dilaksanakan. Selain itu, penyelidikan dan inovasi juga harus dipergiatkan dalam kalangan guru Pendidikan Islam bagi mencari pendekatan, kaedah dan strategi yang sesuai selari dengan peredaran masa. Oleh itu, guru Pendidikan Islam haruslah berlapang dada untuk mencari ilmu pengetahuan dalam meningkatkan profesion keguruan.

KESIMPULAN

Secara kesimpulannya satu anjakan paradigma harus dilakukan oleh guru Pendidikan Islam dalam melaksanakan pengintegrasian TMK supaya pengajaran dan pembelajaran menjadi lebih menarik. Sebelum pelaksanaan pengajaran dilaksanakan, guru Pendidikan Islam seharusnya mempunyai persediaan dari sudut ilmu pengetahuan yang merangkumi pengetahuan teknologi, pengetahuan pedagogi dan pengetahuan kandungan yang terdapat di dalam Model Pengetahuan Teknologi Pedagogi Kandungan oleh Mishra dan Koehler. Namun begitu terdapat beberapa isu dan cabaran yang dihadapi dalam mengintegrasikan TMK dalam pengajaran dan pembelajaran Pendidikan Islam iaitu motivasi guru dan kursus profesion keguruan. Oleh itu, guru Pendidikan Islam seharusnya bekerjasama dengan semua pihak bagi memastikan pengajaran yang diberikan adalah yang terbaik daripada guru yang terbaik dan berpengalaman. Kajian ini diharap dapat dimanfaatkan kepada guru Pendidikan Islam dan pengkaji akan datang dalam usaha meningkatkan pengintegrasian TMK dalam pengajaran dan pembelajaran.. Sebagai penambahbaikan bagi kajian lanjutan, pengkaji mencadangkan supaya ditambah elemen pengetahuan teknologi pedagogi kandungan (PTPK) bagi melihat pengintegrasian semua elemen iaitu teknologi pedagogi kandungan dalam satu masa.

RUJUKAN

- Abdul Wahab, N. S., Febrian, D., Sjahrony, A., Mustapha, R., & Lubis, M. A. (2017). Kefahaman Al- Quran dan Jawi Melalui Bahan Bermultimedia. *ASEAN Comparative Education Research Journal on Islam and Civilization (ACER-J)*, 1(1), 41-53.
- Aguinaldo, B.E. (2017). Developing and Applying Technological Pedagogical and Content Knowledge (TPACK) For A Blended Learning Environment : A Rural Higher Education Experience in Philippines. *Countryside Dvelopment Research Journal*, 4(1), 27-35.
- Aishah, S., & Jamian, A.R. (2016). Pelaksanaan Komuniti Pembelajaran Profesional (Kpp) Untuk Peningkatan Kemahiran Guru Bahasa Melayu Mengajar Penulisan Karangan. *Jurnal Kurikulum & Pengajaran Asia Pasifik*, 4(3), 1-10.
- Angeli, C., & Valanides, N. (2005). Preservice elementary teachers as information and communication technology designers: an instructional systems design model based on an expanded view of pedagogical content knowledge. *Journal of Computer Assisted Learning*, 21(4), 292-302. doi: <https://doi.org/10.1111/j.1365-2729.2005.00135.x>
- Antin, A., & Kiflee, D.N. (2018). Pengaruh Beban Tugas dan Motivasi Terhadap Keefisienan Kerja Guru Sekolah Menengah di Sabah. *Malaysian Journal of Social Sciences and Humanities(MJSSH)*, 3(2), 77 - 84.
- Aslan, A., & Zhu, C. (2016). Influencing Factors and Integration of ICT into Teaching Practices of Preservice and Starting Teachers. *International Journal of Research in Education and Science*, 2(2), 359 - 370. doi:10.21890/ijres.81048
- Bashah, M.A., & Zulkifli, H. (2022). Isu dan Cabaran Guru Pendidikan Islam dalam Penerapan Pendidikan Digital. *International Journal of Advanced Research in Islamic Studies and Education (ARISE)*, 2(1), 43-55.

- Chee, J., Nor, M. M., Abdul Rahman, M. N., & Othman, A. J. (2018). Isu Pengetahuan Kandungan, Pedagogi dan Teknologi dalam Kalangan Guru Pra Sekolah. *Jurnal Kurikulum & Pengajaran Asia Pasifik*, 1, 7-21.
- Dalila, S.H., & Yunus, M.M. (2021). Kesan Pndemik Covid 19 Terhadap Pencapaian Tahap Akedemik Murid. *JMS*, 4(1), 313–343.
- Guat, T.M. (2017). Pengetahuan Teknologi Pedagogi Kandungan dalam Kalangan Pelajar Institut Pendidikan Guru. *Jurnal Penyelidikan IPGKBL*, 14 , 17-28.
- Hilmi, A., Zakaria, Z.M. & Fatimah, A. (2020). Tahap Pengetahuan Guru Bahasa Arab Dalam Melaksanakan Kelas Berbalik. *MJSSH Online*, 4(3), 50-67. doi: <https://doi.org/10.33306/mjssh/81>
- Ishak, A. (1989). *Sejarah Perkembangan Pelajaran dan Pendidikan Islam*. Kuala Lumpur: Al-Rahmaniah, Badan Dakwah dan Kebajikan Malaysia.
- Ishak, W.H., & Yamin, F.M. (2019). Tahap Literasi ICT Pelajar: Suatu Tinjauan. *Proceeding: 2nd International Conference on Economy, Social and Technology (ICEST 2019)*, 4, pp. 228-232. Pahang. doi:10.35631/IJEPC.432005
- Iywon, V.P., & Nasri, N.M. (2020). Tahap Kesediaan dan Sokongan bagi Pelaksanaan Pendekatan Penggunaan Teknologi Maklumat dan Komunikasi dalam Pengajaran dan Pembelajaran Guru Sekolah Rendah. *International Journal of Education and Pedagogy*, 2(4),489-508.
- Jasmi, K.A., & Tamuri, A.H. (2007). *Pendidikan Islam Kaedah Pengajaran dan Pembelajaran* . Johor Bharu: Penerbit UTM Press.
- Jit, J.A., & Ngen, L.S. (2020). *Guru Sebagai Pakar*. Kuala Lumpur: PTS Media Group Sdn. Bhd.
- Kaviza.M. (2021). Hubungan antara Penggunaan Aplikasi Google Classroom Terhadap Pencapaian dalam Pembelajaran Sejarah. *Malaysian Journal of Social Sciences and Humanities (MJSSH)*, 6(1), 61 -69. doi:<https://doi.org/10.47405/mjssh.v6i1.639>
- Keow, C.L . (2012). *Murid dan Alam Belajar*. Kuala Lumpur: Percetakan Seasons Sdn. Bhd.
- Kementerian Pendidikan Malaysia . (2012). *Pelan Strategik Interim Kementerian Pendidikan Malayisa 2011 - 202* . Putrajaya: Bahagian Perancangan dan Penyelidikan Dasar Pendidikan.
- Kementerian Pendidikan Malaysia.(2021). *Laporan Aanalisis Keputusan Peperiksaan Sijil Pelajaran Malaysia 2020*. Putrajaya : Lembaga Peperiksaan .
- Kementerian Pendidikan Malaysia. (2013). *Pelan Pembangunan Pendidikan Malaysia 2013 - 2025*. Putrajaya: Kementerian Pendidikan Malaysia.
- Kementerian Pendidikan Malaysia. (2016). *Panduan Pelaksanaan Modul Teknologi Maklumat dan Komunikasi* . Putrajaya: Bahagian Pembangunan Kurikulum.
- Kementerian Pendidikan Malaysia. (2018). *Dokumen Standard Kurikulum dan Pentaksiran Matematik*.Putrajaya: Bahagian Pembahagian Kurikulum, Kementerian Pendidikan Malaysia.
- Kementerian Pendidikan Malaysia. (2020). *Laporan Analisis Keputusan Peperiksaan Sijil Pelajaran Malaysia 2019*. Putrajaya: Lembaga Peperiksaan.
- Lamsah, S. (2017). Pengajaran dan Pembelajaran Melalui Aplikasi Whatsapp dan Telegram di Universiti Swasta. *Jurnal Pendidikan Malaysia*, 42(2), 87-97. doi:10.17576/JPEN-2017-42.02-02
- Law, M.L. & Mahmud, M.S. (2021). Pengintegrasian Pengetahuan Teknologi Pedagogi Kandungan (PTPK). *5th International Conference on Teacher Learning and Development (ICTLD) 2021*, 995-1005.

- Lubis, M. A., Syuhada, W.N, & Hamzah, M. I. (2017). Tahap Pengetahuan dan Kesiapan Guru Pendidikan Islam Sekolah Menengah di Selangor Terhadap Penggunaan Multimedia dalam Pengajaran Pendidikan Islam. *ASEAN Comparative Education Research Journal on Islam and Civilization (ACER-J)*, 1(1), 1-13.
- Marhaton, A. (2021 April 29). PdPR kurang efektif, pelajar tertekan. *Utusan Malaysia*.
<https://www.utusan.com.my/ekonomi/2021/04/pdpr-kurang-efektif-pelajar-tertekan/>
- Marjonet, J., & Hajar, S. (2020). Pementoran dalam Program Pembangunan Guru Baharu Kementerian Pendidikan Malaysia. *The Malaysian Journal of Social Administration*, 79-95.
- Masingan, C., & Shari, S. (2019). Pengetahuan Pedagogi Kandungan (PPK) Guru Bukan Pengkhususan Reka Bentuk dan Teknologi(RBT) di Sekolah Menengah. *Malaysian Journal of Social Sciences and Humanities (MJSSH)*, 4(6), 64-71.
doi:<https://doi.org/10.47405/mjssh.v4i6.279>
- Mishra, P., & Koehler, M.J. (2008). *Introducing TPACK In Commitee on Innovation and TechologyHandbook of technological pedagogical content knowledge (TPACK) for educator*. New York: Routledge.
- Mohd Nawawi, M. Z., Hashim, A., & Muhammad, N. (2020). Integrasi Penggunaan Teknologi Pelbagai Media Oleh Guru Pendidikan Islam di Maahad Yayasan Islam Kelantan. *Jurnal Sains dan Pendidikan Teknikal*, 1(1), 73-88.
- Muhbar, F., & Rochmawati, D.H. (2017). Hubungan Antara Tingkat Stres Dengan Beban Kerja Guru Di Sekolah Luar Biasa. *Jurnal Keperawatan*, 5(2), 82-86.
- Najib, M, & Ahmad, N.S. (2008). Kemahiran Belajar dan Hubungannya dengan Pencapaian Akademik ; Kajian di Daerah Kerian, Perak. *Jurnal Pendidik dan Pendidikan*, 23, 29 - 47.
- Nasir, F., Shamsudin, F., & Bakar, A. (2017). *Pengajaran dan Pembelajaran Abad 21* . Selangor: Sasbadi Sdn. Bhd.
- Omar, A. (2016). Integrasi Teknologi dalam Pengajaran Dan Pembelajaran Kesusasteraan Melayu Mempertingkatkan Keyakinan dan Keberhasilan Guru Semasa Latihan Mengajar. *JPBU*, 9, 13-25.
- Peng, C.A, & Daud, S.M. (2017). Pengetahuan Teknologi Pedagogi Kandungan (PTPK) dalam Kalangan. *International Journal of Education and Training (InJET)*, 3(2), 1-11.
Retrieved from <http://www.injet.upm.edu.my/index.php/archives/vol...>
- Parkay, F.W, & Stanford, B.H. (2010). *Becoming A Teacher* . London: Pearson .
- Rusdi, M. & Ismail, Z. (2018). Pengetahuan Teknologi Guru Bahasa Arab dan Hubungannya dengan Kreativiti Pengajaran di Malaysia. *Jurnal Islam dan Masyarakat Kontemporari*, 18(1), 1-13.
- Ramli, N., & Zulkifli, H. (2022). Tahap Kesiapan dan Motivasi Guru Pendidikan Islam Terhadap Pengajaran dan Pembelajaran Atas Talian. *International Journal of Advanced Research in Islamic Studies and Education (ARISE)*, 2(2), 16-30. Retrieved from <https://myedujournal.com/index.php/arise/article/view/108>
- Salleh, A.M (2011). *Kurikulum, Metodologi, dan Pedagogi Pengajian Islam: KPLI Pengajian Islam @ j-QAF*. Selangor: Oxford Fajar Sdn. Bhd.
- Sam, M.F., Majid, M., Jusoh, A.S., & Kosnon, M.Z. (2013). *Murid dan Alam Belajar*. Selangor: Penerbitan Multimedia Sdn. Bhd.
- Said, R.R., Brahim, M., & Sabil, A.M. (2016). Bimbingan dan Pementoran Berfokus oleh Sisc+ Bm: Impak terhadap Kualiti Pengajaran Guru Bahasa Melayu di Sekolah-sekolah Menengah Daerah Samarahan, Sarawak. *Jurnal Pendidikan Malaysia*, 41(2), 131-139.
- Vinathan, T. (2016). Hubungan Motivasi Guru Dengan Penggunaan Ict Dalam Pengajaran Di SJKT di Daerah Yan. *International Seminar on Generating Knowledge Through Research, UUM-UMSIDA* (pp. 25-27). Malaysia: Universiti Utara Malaysia,.

- Wahab, N.A., Muhammad, N., & Ismail, M.S. (2020). Analisis Keberkesanan Penggunaan ICT dalam Mendepani Gelombang Revolusi Industri 4.0 dalam Kalangan Pelajar di Negeri Terengganu, Malaysia. *Asian People Journal*, 3(1), 101-109. doi: <https://doi.org/10.37231/apj.2020.3.1.149>
- Wah, W.K., Esa, N.M., Lee, T.A., & Nizam, R.A. (2019). *Kemahiran Belajar*. Selangor: Oxford Fajar Sdn. Bhd.
- Yeh, Y.F., Hsu, Y.S., Wu, H.K., Hwang, F.K., & Lin, T.C. (2014). Developing and Validating Technological Pedagogical Content Knowledge-Practical (TPACK-practical) through the Delphi Survey Technique. *British Journal of Educational Technology*, 45(4), 707–722. doi:<https://doi.org/10.1111/bjet.12078>
- Yunos, M. (2015). Hubungan Sikap Dan Persepsi Murid Terhadap Pembelajaran Bahasa. *Jurnal Pendidikan Bahasa Melayu – JPBM (Malay Language Education Journal – MyLEJ)*, 5(2), 22-30. Retrieved 4 10, 2022, from <http://spaj.ukm.my/jpbm/index.php/jpbm/issue/view/...>
- Zakaria, S. R., Hamzah, M. I., & Abdul Razak, K. (2017). Penggunaan ICT dalam Pengajaran dan Pembelajaran Pensyarah. *Tinta Artikulasi Membina Ummah*, 3(1), 29-41.
- Zin, O. (2022, Mac 3). Banyak Tugas Sampingan Punca Ramai Bersara Awal. *Utusan Malaysia*.<https://www.utusan.com.my/nasional/2022/03/banyak-tugas-sampingan-punca-ramai-bersara-awal/>

Memperkasa Industri Pelancongan dalam Masyarakat Nelayan di Malaysia

Mohamad Zaki Ahmad
Universiti Utara Malaysia
zaki.ahmad@uum.edu.my

Norria Zakaria
Universiti Utara Malaysia
norria@uum.edu.my

Mohd Rushdi Idrus
Universiti Utara Malaysia
rushdi@uum.edu.my

ABSTRACT

The tourism industry has great potential to be created on a large scale in the fishing community. It is important to change the orientation of livelihoods and sources of income for fishermen who depend a lot on fishing activities. When it's out of fishing season, the catch and source of income start to suffer. Therefore, the government need to strengthen their efforts since many resources in the fishing area can be utilised for tourism. Although the majority of fishermen are in the B40 category, it is not a reason for them not to be successful in other fields if they have an interest and get strong support from the government. So, entrepreneurship and tourism are two economic sectors that have the potential to help the fishing community earn a consistent income without being too dependent on seafood. Thus, the fishing community can venture into entrepreneurship programmes in tourism-related activities since tourism-related resources that have the potential to be commercialised are available to be utilised. Among them is a way of life that involves aspects of fisherman's life, culture, food, art, and environmental attractions. In some fishing settlements whose locality is based on the coasts and islands, the business of country lodging or tourist chalets indeed has great potential to be developed. In addition, the promotion of fresh seafood with a variety of tastes, including the original menu of the fishing community, needs to be strengthened with the involvement of women and young people from the fishing community.

Keywords: *policy, entrepreneurship; tourism, fishing community.*

ABSTRAK

Industri pelancongan mempunyai potensi besar untuk diwujudkan secara besar-besaran dalam masyarakat nelayan. Hal ini penting untuk mengubah orientasi mata pencarian dan sumber pendapatan nelayan yang banyak bergantung kepada aktiviti penangkapan ikan. Apabila di luar musim menangkap ikan, hasil dan sumber pendapatan mula terjejas. Jadi, usaha perlu diperkasa oleh kerajaan kerana banyak sumber di kawasan nelayan yang boleh dimanfaatkan untuk pelancongan. Walaupun majoriti nelayan dalam kategori B40, tetapi bukan alasan untuk mereka tidak boleh berjaya dalam bidang lain jika mempunyai minat serta mendapat sokongan kuat kerajaan. Jadi, keusahawanan dan pelancongan merupakan dua sektor ekonomi yang berpotensi membantu masyarakat nelayan memperolehi pendapatan yang konsisten tanpa bergantung penuh terhadap hasil tangkapan laut. Justeru, program keusahawanan dalam aktiviti berkaitan pelancongan berpotensi untuk diceburi oleh masyarakat nelayan memandangkan sumber berkaitan pelancongan yang berpotensi untuk dikomersialkan adalah tersedia untuk diusahakan. Antaranya cara hidup yang melibatkan aspek kehidupan nelayan, kebudayaan, makanan, kesenian, dan tarikan alam sekitar. Di

beberapa penempatan nelayan yang lokalitinya berteraskan pantai dan kepulauan, pengusaha inap desa atau chalet pelancong sememangnya mempunyai potensi yang besar untuk dibangunkan. Promosi makanan laut segar dengan kepelbagaian citarasa termasuk menu asli masyarakat nelayan juga perlu diperkasa dengan penglibatan kaum wanita dan golongan muda masyarakat nelayan.

Kata Kunci: dasar; keusahawanan; pelancongan; masyarakat nelayan.

PENGENALAN

Bagi menjamin kemajuan, perkembangan, kejayaan pengoperasian dan kemampuan pelancongan itu sendiri, sokongan masyarakat setempat adalah amat penting memandangkan pelancongan amat bergantung kepada kerjasama dan sikap muhibah (*goodwill*) mereka (Jurowski et al., 1997). Apabila sesebuah komuniti itu menjadi satu destinasi pelancongan, kualiti hidup penduduk tempatan akan dipengaruhi oleh kesan-kesan akibat daripada pembangunan pelancongan (Gursoy et al., 2002). Sikap, penyertaan dan persetujuan daripada penduduk dapat memberi panduan kepada pembangunan pelancongan untuk mengelak daripada berlakunya percanggahan pendapat dan kepentingan antara industri pelancongan dengan masyarakat setempat (Sheldon dan Abenoja, 2001).

Kejayaan sesuatu projek pelancongan akan terancam sekiranya pembangunan projek tersebut tidak dirancang dan dibangunkan tanpa pengetahuan dan penyertaan penduduk setempat (Gursoy et al., 2002). Kejayaan industri pelancongan juga bukan sahaja bergantung sepenuhnya kepada tarikan dan perkhidmatan yang berkaitan, malahan sokongan dan hospitaliti penduduk tempatan adalah amat diperlukan. Menurut Gursoy et al. (2002) lagi, kemarahan, ketidakpuasan hati, sikap tidak ambil peduli dan hilang kepercayaan di kalangan penduduk akan memberi gambaran buruk kepada para pelancong yang akhirnya boleh menyebabkan mereka menolak untuk melawat tempat di mana mereka merasakan amat tidak dialu-alukan. Oleh itu, dalam memperkasakan industri pelancongan di penempatan dan lokaliti masyarakat nelayan terutamanya bagi mendapatkan sokongan mereka terhadap pembangunan pelancongan, memahami dengan lebih mendalam reaksi penduduk dan faktor-faktor yang mempengaruhi sikap mereka terhadap pelancongan adalah penting.

Keusahawanan dan pelancongan adalah dua sektor ekonomi yang berpotensi membantu masyarakat nelayan memperolehi pendapatan yang konsisten tanpa bergantung penuh terhadap hasil tangkapan daripada laut. Di sebalik faktor-faktor yang mengganggu-gugat pendapatan nelayan seperti cuaca buruk dan pencemaran laut, sudah tiba masanya untuk masyarakat nelayan diberi pemahaman dan kesedaran bahawa 'sumber laut' yang menyumbang kepada pendapatan mereka selama ini adalah tidak bersifat kekal dan berhadapan dengan senario kepupusan atau penyusutan populasi. Jika selama ini agak terlalu banyak bantuan dan sumbangan yang diterima daripada pihak kerajaan atau badan-badan yang tertentu sekiranya pendapatan mereka terjejas, masyarakat nelayan perlu keluar daripada zon selesa ini dan membuat persediaan awal sekiranya segala bentuk bantuan berkenaan dihentikan. Keadaan ini tidak mustahil akan berlaku sebagaimana senario ketidakstabilan ekonomi serantau yang turut diburukkan lagi oleh senario politik semasa negara yang dilihat agak kucar-kacir.

Maka, daripada selesa diberikan 'ikan' selama ini, masyarakat nelayan perlu berusaha 'menggunakan segala bentuk dan cara termasuk menggunakan pancing bagi menangkap ikan'. Dalam konteks ini, aktiviti keusahawanan termasuklah aktiviti berkaitan pelancongan dilihat amat berpotensi untuk diceburi oleh masyarakat nelayan memandangkan dikebanyakan

penempatan mereka, sumber berkaitan pelancongan yang berpotensi untuk dikomersialkan adalah tersedia untuk diusahakan.

KAEDAH KAJIAN

Perbincangan bagi topik kertas kerja ini adalah merujuk kepada “**Kajian Impak Keberkesanan Dasar dan Program Bantuan Kerajaan kepada Masyarakat Nelayan di Malaysia**” (dirujuk sebagai Kajian Impak Keberkesanan), satu projek perundingan antara pasukan penyelidik dari Universiti Utara Malaysia (UUM) dengan Lembaga Kemajuan Ikan Malaysia (LKIM). Secara umumnya, kajian ini melibatkan kesemua 89 Persatuan Nelayan Kawasan (PNK) di seluruh negara dengan jumlah responden melebihi 7,000 orang. Kerja lapangan bagi pengumpulan data telah dijalankan dalam tempoh dua bulan bermula 01 Disember 2021 hingga 31 Januari 2022.

Bagi kajian impak keberkesanan dasar dan program bantuan kerajaan kepada masyarakat nelayan di Malaysia adalah berupa kajian tinjauan yang menggunakan soal selidik untuk mendapatkan maklum balas daripada responden. Namun, di peringkat awal kajian ini, sumber-sumber sekunder seperti buku, artikel jurnal, laporan penyelidikan, tesis, dokumen rasmi kerajaan dan akhbar-akhbar tempatan telah diteliti bagi mendapat pelbagai maklumat.

Secara umumnya kajian ini dijalankan bertujuan menilai keberkesanan impak dasar dan program kerajaan kepada masyarakat nelayan di Malaysia khususnya sewaktu negara berada dalam PKP 1.0. Objektif khusus bagi kajian ini adalah seperti berikut:

- a) Mengenal pasti kecenderungan sokongan nelayan terhadap kerajaan mengikut kriteria hitam, kelabu atau putih;
- b) Mengkaji faktor dominan mempengaruhi sokongan masyarakat nelayan kepada kerajaan;
- c) Menganalisis impak pemberian bantuan kerajaan terhadap kecenderungan sokongan nelayan kepada kerajaan; dan
- d) Mengemukakan cadangan kepada kerajaan ke arah meningkatkan sokongan masyarakat nelayan menjelang PRU-15.

Proses pengumpulan data bagi kajian ini melibatkan pengumpulan data sekunder dan data primer. Bagi data sekunder, ia melibatkan penggunaan dan penelitian bahan atau sumber sekunder yang sedia ada dalam bentuk buku, artikel jurnal, laporan penyelidikan, tesis, prosiding seminar, kertas kerja seminar, laporan rasmi kerajaan seperti Laporan Tahunan LKIM, majalah, akhbar dan lain-lain yang telah didokumentasikan sama ada dalam bentuk bercetak atau elektronik.

Pengumpulan data primer pula menggunakan borang soal selidik atas talian (*Google Form*), di mana pautan (*link*) dikongsikan kepada pembanci untuk diedarkan kepada responden yang telah dipilih. Namun, borang bercetak juga digunakan sebagai alternatif bagi nelayan yang tiada kemudahan telefon pintar dan Internet. Dalam hal ini, data primer merupakan data yang dikumpulkan sendiri oleh penyelidik menggunakan *Google Form*, di mana sampelnya adalah nelayan yang menerima elaun sara hidup daripada kerajaan.

PERBINCANGAN DAN CADANGAN

Impak Pelancongan

Berdasarkan Kajian Impak Keberkesanan, aktiviti berteraskan pelancongan dilihat sebagai satu aktiviti ekonomi yang berpotensi besar dalam meningkatkan sosioekonomi serta sosiobudaya masyarakat nelayan. Sebagai satu industri yang dinamik, pelancongan menawarkan komuniti dalam semua bentuk dan saiz peluang-peluang pembangunan yang unik. Bagaimanapun, dalam kes-kes tertentu tidak semua komuniti adalah sesuai dengan pelancongan, malahan pembangunan pelancongan tidak semestinya sesuai untuk setiap komuniti. Impak pelancongan datang dalam pelbagai bentuk dan keadaan.

Secara umumnya, impak pelancongan adalah sama ada ianya positif atau negatif bergantung kepada ciri-ciri kawasan berkaitan (jenis dan sejauh mana pelancongan telah dimajukan) dan ciri-ciri masyarakat setempat (penerimaan terhadap kesan-kesan berkenaan). Impak pelancongan juga pada kebiasaannya dibincangkan dari sudut ekonomi, sosiobudaya dan persekitaran (alam sekitar). Malahan, jenis dan kepentingan impak pelancongan adalah berbeza antara satu komuniti dengan komuniti yang lain. Secara umum, saiz, sifat dan had bagi impak pelancongan adalah bergantung kepada faktor-faktor seperti dalam **Jadual 1**.

Jadual 1: Faktor-faktor yang mempengaruhi saiz, sifat dan impak pelancongan

Faktor-faktor yang mempengaruhi Saiz, Sifat dan Impak Pelancongan
• Jumlah aktiviti pelancong berbanding aktiviti masyarakat setempat
• Tahap kepadatan atau keselerakan aktiviti pelancong di kawasan berkaitan
• Tempoh dan sifat hubungan pelancong dengan komuniti
• Kestabilan atau sensitiviti struktur ekonomi, sosial dan persekitaran setempat
• Persamaan atau perbezaan antara masyarakat tempatan dan pelancong
• Bagaimana baik pelancongan dirancang, dikawal dan diuruskan.

Memandangkan potensi ekonomi dan peluang keusahawanannya yang besar, banyak tempat yang membangunkan pelancongan terutamanya atas alasan penjanaan peluang-peluang pekerjaan, penjanaan pendapatan yang lebih baik dan industri pelancongan yang sering disifatkan sebagai satu industri “tanpa pencemaran” yang *smokeless and clean* (tanpa asap dan bersih). Tambahan pula, pelancongan dapat membantu melindungi alam sekitar, menjaga dan memulihara aspek warisan budaya dan meningkatkan kualiti hidup masyarakat setempat. Penduduk tempatan mungkin akan menerima impak positif dan negatif akibat daripada pembangunan pelancongan. Pembangunan pelancongan dapat menyediakan lebih banyak peluang pekerjaan dan dapat meningkatkan pendapatan penduduk tempatan. Penduduk juga akan dapat menikmati faedah daripada perkhidmatan yang disediakan oleh sektor pelancongan. Pembangunan pelancongan turut menyediakan banyak peluang perniagaan kepada komuniti setempat antaranya mengusahakan restoran, kedai cenderamata, pasar mini dan beberapa peluang berkaitan industri kecil dan sederhana.

Bagaimanapun, pelancongan juga akan menyumbangkan impak-impak negatif jika dibangunkan tanpa perancangan yang berkesan dan menyeluruh. Pembangunan pelancongan juga mungkin akan menyumbang kepada beberapa masalah seperti kesesakan lalulintas, pencemaran, kenaikan harga barang dan peningkatan nilai hartanah. Malahan, kualiti persekitaran dan kehidupan komuniti sama ada akan meningkat atau merosot disebabkan pembangunan pelancongan dalam komuniti tersebut. Namun, ianya bergantung kepada ‘sifat’ atau ‘jenis’ pembangunan pelancongan, keutamaan dan keinginan penduduk setempat dan bagaimana wajarnya pelancongan dirancang dan diuruskan di komuniti tersebut. **Jadual 2**

menyenaraikan impak-impak ekonomi, sosiobudaya dan persekitaran berkaitan pembangunan dan aktiviti pelancongan secara umum.

Manfaat daripada pelancongan tidak hanya berlaku begitu sahaja. Pelaburan dalam bentuk bakat, masa, modal dan dana operasi, semangat dan keazaman serta kerjasama komuniti adalah amat diperlukan untuk menjadikan pelancongan satu aspek penting dalam kehidupan ekonomi komuniti setempat. Kemungkinan, penghalang utama kepada pembangunan pelancongan adalah kurangnya penghargaan dan minat daripada pemimpin-pemimpin tempatan dan ahli-ahli perniagaan. Apabila pelancongan tidak difahami sepenuhnya dan manfaatnya pula tidak begitu jelas, perancangan teliti dan pelaksanaan tindakan yang berkaitan bagi meningkatkan industri pelancongan akan menjadi kurang berkesan.

Jadual 2: Impak pelancongan umum

IMPAK PELANCONGAN (secara umum)	
Impak Ekonomi	
	<ul style="list-style-type: none"> • Peluang pekerjaan • Meningkatkan pendapatan • Pertukaran matawang asing • Pendapatan Kerajaan melalui cukai • Kos infrastruktur • Peningkatan harga barangan • Gangguan struktur ekonomi dan gunatenaga • Kebocoran ekonomi (<i>leakages</i>) ke luar Negara
Impak Sosiobudaya	
	<ul style="list-style-type: none"> • Pemuliharaan warisan budaya • Desan demonstrasi (<i>Demonstration effect</i>) • Gangguan kepada struktur dan pengagihan populasi • Pertukaran silang budaya • Peluang pendidikan • Aspek keselamatan dan kawalan • Masalah sosial • Kualiti hidup masyarakat • Kesusakan
Impak Persekitaran	
	<ul style="list-style-type: none"> • Pemuliharaan sumberjaya alam semulajadi dan buatan • Memperbaiki kualiti alam sekitar dan infrastruktur • Meningkatkan daya tarikan alam sekitar • Meningkatkan kepekaan kepada alam sekitar • Pencemaran air, udara, bunyi dan pemandangan • Masalah pembuangan sisa • Gangguan ekologi • Masalah kegunaan tanah

Sumber: Inskeep (1991).

Pelancongan dan Masyarakat

Seperti yang diperkatakan oleh para ilmuwan melalui kajian mereka yang berkaitan, sekiranya masyarakat setempat percaya atau mempunyai persepsi bahawa faedah dan kesan positif pelancongan kepada masyarakat tempatan mengatasi keburukan atau kesan negatif, maka mereka cenderung untuk berpuas hati dengan pembangunan pelancongan dan ini seterusnya dapat menyumbang ke arah kejayaan dan kelestarian pembangunan pelancongan. (Sharpley 1994; Jurowski *et al.* 1997; Wang & Pfister 2008 dan Sharpley 2014). Dalam hal ini, dapat dinyatakan bahawa menilai persepsi atau tanggapan masyarakat setempat terhadap impak pelancongan adalah penting ke arah pembangunan pelancongan yang mapan dan memberikan manfaat yang optimum kepada masyarakat khususnya. Justeru, masyarakat nelayan perlu diberi pendedahan tentang faedah yang bakal dijana melalui pelancongan, dan pada masa yang sama diberi ‘peringatan’ tentang impak negatif sekiranya pelancongan dibangunkan tanpa perancangan yang sewajarnya.

Dalam pembangunan pelancongan, masyarakat tempatan adalah pihak yang secara ketara (dan dalam kes tertentu secara berkekalan) akan dipengaruhi oleh pembangunan pelancongan di kawasan mereka. Perkara ini perlu diperjelaskan kepada masyarakat nelayan yang bakal melibatkan dengan industri pelancongan. Ini adalah kerana mereka adalah pihak yang akan dipengaruhi secara langsung oleh kesan yang dicetuskan melalui pembangunan pelancongan di kawasan mereka. Sama ada kesan pelancongan tersebut adalah positif atau sebaliknya, masyarakat setempat tidak mempunyai pilihan melainkan terpaksa membuat adaptasi bagi meneruskan kelangsungan hidup mereka di situ. Malahan, ada dalam kalangan masyarakat tempatan yang terlibat secara langsung sebagai pembekal atau penyedia perkhidmatan-perkhidmatan seperti penginapan, katering, informasi, pengangkutan, dan kemudahan-kemudahan pelancongan yang lain. Maka, dalam hal ini perlu dipastikan agar bentuk pembangunan masa hadapan memberikan penekanan yang besar terhadap aspek kesejahteraan hidup masyarakat dan kelangsungan sumberjaya pelancongan demi memastikan agar impak positif yang bakal dicetuskan mengatasi impak negatif. Melalui kajian oleh Ahmad (2017) dinyatakan bahawa responden (masyarakat nelayan) mempunyai pandangan bahawa pelancongan berupaya menjana sama ada kesan positif atau negatif kepada masyarakat tempatan; namun, kesan-kesan ini dilihat dari sudut yang berbeza di kalangan masyarakat. Dalam konteks ini, secara umumnya masyarakat nelayan percaya bahawa pelancongan memberi kesan kepada masyarakat tempatan melalui ekonomi, sosiobudaya, ekologi dan alam sekitar (Ahmad, 2017).

Penyertaan masyarakat tempatan dalam pelancongan dilihat sebagai satu kuasa positif untuk perubahan dan ianya dapat bertindak sebagai pemangkin kepada pembangunan. Seperti yang diperdebatkan sebelum ini, mengetahui dan memahami persepsi penduduk tempatan terhadap pembangunan pelancongan mempunyai pengaruh yang besar ke atas kemampuan pembangunan pelancongan di sesebuah destinasi. Berdasarkan beberapa kajian terdahulu, kesan persepsi positif penduduk masyarakat mempengaruhi sikap positif mereka untuk menyokong dan berkerjasama untuk terlibat dalam pembangunan pelancongan di kawasan mereka (Saufi *et al.* 2014; Walpole & Goodwin 2001). Dalam hal ini, pembangunan pelancongan lestari banyak bergantung kepada hubungan baik masyarakat tempatan, sokongan mereka, dan penglibatan mereka dalam aktiviti dan program yang berkaitan.

Pelancongan dan Keusahawanan

Pembangunan pelancongan dilihat sebagai aktiviti ekonomi yang penting dalam meningkatkan ekonomi penduduk tempatan. Banyak kajian yang mencadangkan bahawa pembangunan dan promosi pelancongan merupakan sumber baru bagi pendapatan, pekerjaan, pendapatan cukai tambahan, faedah pertukaran asing, dan peningkatan infrastruktur masyarakat tempatan. Pembangunan pelancongan dapat menarik dan mampu menyumbang untuk memajukan

industri-industri lain (Lankford dan Howard, 1994). Sehingga hari ini, pembangunan dan usaha penggalakan industri pelancongan telah diterima ramai sebagai satu langkah ekonomi yang positif terutamanya di negara-negara maju (Cooke, 1982). Malahan, Huang dan Stewart (1996) mendapati bahawa pembangunan pelancongan dapat mengubah hubungan penduduk antara satu sama lain dan hubungan penduduk sesuatu petempatan dengan petempatan yang lain. Secara umum, didapati bahawa tanggapan dan sikap penduduk terhadap impak-impak pelancongan dijadikan pertimbangan penting bagi perancangan dan polisi untuk menjamin kejayaan pembangunan pelancongan, pemasaran dan pengoperasian program pelancongan sedia ada dan yang akan datang (Ap, 1992).

Pembangunan pelancongan tanpa integrasi dengan nilai-nilai serta persekitaran setempat juga boleh mengakibatkan kerosakan sosial, budaya, persekitaran dan ekonomi terhadap komuniti setempat (Sheldon dan Abenoja, 2001). Garrod (1998) menjelaskan: "Pelancongan tidak boleh lagi dilihat sebagai aktiviti komersial yang tidak mempunyai kesan yang signifikan terhadap persekitaran semulajadi, buatan dan persekitaran sosiobudaya di mana ianya mengambil tempat". Dengan memberi pertimbangan terhadap faktor interaksi manusia khususnya, hubungan dengan penduduk tempatan adalah penting dalam pembangunan pelancongan (Marsh dan Henshall, 1987). Sheldon dan Abenoja (2001) pula mendakwa bahawa pengalaman subjektif pelancong adalah dipengaruhi terutamanya oleh persekitaran, sifat, kedalaman dan kualiti interaksi mereka dengan penduduk tempatan. Dalam hal ini, beberapa kajian mendapati bahawa sikap penduduk secara langsung memberikan kesan kepada keseronokan dan pengalaman pelancong (Davis et al., 1988; Cooke, 1982; Allen et al., 1988; Johnson et al., 1994; Pizam, 1978). Melalui kajian-kajian ini, para penyelidik dan penggubal dasar telah mengenalpasti sentimen penduduk dan apa yang dititikberatkan oleh mereka bagi memandu kepada satu bentuk pembangunan bersesuaian dan bertepatan dengan nilai-nilai setempat, meminimalkan pergeseran dan konflik antara pelawat dan penduduk setempat, dan mewujudkan perkongsian yang menguntungkan komuniti dan industri pelancongan itu sendiri.

Garrod dan Fyall (1998) pula menekankan bahawa pelancongan lestari bagi sesebuah komuniti sememangnya memerlukan hubungan yang harmoni antara para pelawat, penduduk dan tempat, tanpa mengurangkan sumberjaya tempatan, penipuan terhadap pelawat, tanpa pengeksploitasian penduduk setempat. Malahan, pelancongan lestari di sesebuah komuniti tidak dapat dimaklumkan dan diterapkan kepada umum secara meluas tanpa sokongan, penyertaan dan kepuasan penduduk tempatan. Lankford dan Howard (1994) menegaskan bahawa kawalan yang dirasakan penduduk ke atas pembangunan pelancongan juga akan turut mempengaruhi sikap mereka terhadap pelancongan. Malahan, menurut Lankford dan Howard (1994) lagi ketidakwujudan atau kekurangan input penduduk setempat dalam proses membuat keputusan boleh menyumbang kepada rasa kurang senang penduduk terhadap pelancongan di komuniti mereka, mengikis toleransi penduduk terhadap pelancong dan seterusnya meningkatkan sensitiviti mereka terhadap impak negatif akibat daripada pembangunan pelancongan untuk jangkamasa yang akan datang.

Berdasarkan perbincangan di atas, beberapa **cadangan** dilihat perlu untuk dilaksanakan bagi menarik minat masyarakat nelayan untuk melibatkan diri dalam aktiviti serta pembangunan pelancongan di lokaliti mereka. Antaranya adalah mempromosikan cara hidup yang melibatkan aspek kehidupan nelayan seperti kebudayaan, makanan, kesenian dan tarikan alam sekitar. Di beberapa penempatan nelayan yang lokalitinya berteraskan pantai dan kepulauan, pengusahaan inap desa atau chalet pelancong sememangnya mempunyai potensi yang besar untuk dibangunkan. Promosi makanan laut segar dengan kepelbagaian citarasa termasuk menu 'asli' masyarakat nelayan juga perlu diperkasakan dengan penglibatan kaum wanita (isteri) dan golongan muda (anak-anak) masyarakat nelayan.

Masyarakat nelayan juga digalakkan untuk melibatkan diri serta menyertai program seperti berikut:

- Kempen pengurusan ‘pintar’ kewangan perlu dilaksanakan bagi membantu masyarakat nelayan menguruskan pendapatan mereka yang tidak konsisten demi kelangsungan hidup yang lebih sejahtera (dicadang untuk dimulakan di peringkat sekolah)
- Program komunikasi ‘berkesan’ untuk mempersiapkan diri berurusan dengan masyarakat luar (pelanggan, pembekal, pelancong, pelawat) dalam mereka melaksanakan aktiviti ekonomi berkaitan keusahawanan dan pelancongan (kursus pekerja barisan hadapan - *frontliner course*, kursus komunikasi pelanggan)
- Memperkasa jati diri dan menghakis stigma terhadap pandangan inferior masyarakat umum kepada masyarakat nelayan yang dilihat sebagai ‘golongan bawahan tiada masa hadapan yang sentiasa mengharapkan bantuan’ melalui penganjuran program motivasi kepada golongan muda dengan mengangkat peranan dan tanggung jawab sosial nelayan yang sama-sama turut menyumbang dalam agenda pembangunan negara (industri perikanan/bekalan makanan/nutrisi) kepada rakyat.

Seterusnya, cadangan-cadangan berikut pula memberikan tumpuan terhadap aspek penyelarasan, perancangan dan pembangunan program pelancongan dan keusahawanan, pendidikan dan peningkatan kesedaran terhadap pelancongan:

- **Pembentukan Jawatankuasa Pemandu** atau lebih dikenali sebagai *Steering Committee* adalah perkara pertama dan paling mustahak untuk diadakan. Jawatankuasa inilah bertindak bagi menyelaraskan kerjasama dan peranan semua pihak berkepentingan dalam membangunkan pelancongan di pekan nelayan ini.
- **Jawatankuasa Pemandu** ini juga akan bertindak sebagai pemerhati, penasihat dan pemantau yang menawarkan pandangan dalam aspek-aspek seperti rancangan pembangunan yang bersepadu dengan mengambilkira beberapa aspek meliputi infrastruktur, pengangkutan, pecahan gunatanah yang bersesuaian, pengurusan pelawat bagi lokasi-lokasi tumpuan pelancong serta garis panduan dan peraturan terhadap pelancong dan pengusaha pelancongan bagi meminimalkan kesan negatif pelancongan terhadap ekonomi, alam sekitar dan sosial. Malahan, Jawatankuasa Pemandu juga akan dilibatkan secara langsung dalam penganjuran dan pelaksanaan agenda-agenda berkenaan yang pastinya bakal merubah senario lanskap pekan nelayan ini kepada sebuah destinasi pelancongan baru. Agenda-agenda berkenaan ialah:
 - merancang program promosi pelancongan,
 - merancang dan melaksana program latihan dan kesedaran pelancongan,
 - merancang dan mencadangkan ‘tema pembangunan’ pelancongan Kuala Kedah yang merangkumi bentuk aktiviti dan tarikan pelancongan yang akan ditawarkan kepada pelancong,
 - menjalankan kajian inventori dan prakebolehlaksana (*prefeasibility*) pelancongan, dan;
 - membangunkan pusat informasi pelancongan.
- **Kempen kesedaran pelancongan dan program latihan pelancongan** perlu dianjurkan dan dilaksanakan secara berkala bagi meningkatkan kesedaran penduduk untuk memahami dengan lebih bermakna tentang pelancongan dan aspek penting yang berkaitan dengan pembangunan pelancongan terutamanya mengenai kepentingan pelancongan, impak positif dan negatif pelancongan serta peluang untuk meningkatkan sosioekonomi masyarakat yang terdapat dan ditawarkan oleh pelancongan.
- **Program kesedaran keusahawanan dan pelancongan** dibentuk untuk meningkatkan pemahaman masyarakat umum tentang kepentingan keusahawanan dan pelancongan terhadap ekonomi setempat. Ini didorong oleh fakta bahawa pendidikan kepada masyarakat, pengamal media tempatan, pihak berkepentingan termasuk para pembuat

keputusan melalui perkongsian maklumat dan kerjasama, akan menjana ‘rasa dihargai’ yang lebih baik dalam kalangan pihak berkenaan terhadap industri pelancongan ini. Kempen media, penganjuran bengkel kesedaran pelancongan, jaringan serta pertukaran maklumat dan penyelidikan adalah antara pelan strategik dalam meningkatkan kesedaran terhadap keusahawanan dan peluang dalam industri pelancongan di kalangan semua pihak berkepentingan di penempatan nelayan. Jerayawara ilmiah, pameran kerjaya dan pertandingan esei adalah beberapa inisiatif yang boleh digunakan untuk meningkatkan kesedaran di kalangan kanak-kanak dan golongan belia. Dalam konteks ini, Program Kesedaran Umum akan merangkumi dua inisiatif utama seperti berikut:

- **Kempen Belia:** Kempen ini menggabungkan semua pihak berkepentingan termasuk pemandu pelancong, agensi keusahawanan, Kementerian Pelancongan dan Kebudayaan Malaysia, ahli akademik dan pertubuhan bukan kerajaan melawat sekolah rendah dan menengah bagi tujuan mendidik golongan muda mengenai industri dan peluang kerjaya yang ditawarkan. Kempen ini juga merangkumi penajaan pertandingan-pertandingan seperti pertandingan Esei dan Poster Pelancongan Masyarakat Setempat, pertandingan fotografi serta pertandingan-pertandingan lain yang memberi pendedahan lanjut kepada pelbagai bidang (*niche*) pelancongan.
- **Forum Keusahawanan dan Perniagaan Pelancongan:** Penganjuran forum ini adalah secara berkala bertujuan untuk memaklumkan kepada pihak berkepentingan mengenai peluang-peluang dan arah aliran (*trend*) baru dalam industri di samping meningkatkan kesedaran dan kefahaman tentang kepentingan pelancongan kepada bidang ekonomi yang pelbagai. Inisiatif ini disasarkan kepada media, pihak-pihak kepentingan, Perusahaan Kecil dan Sederhana (PKS) pelancongan, ahli-ahli komuniti perniagaan dan ianya bertujuan untuk meningkatkan profil industri pelancongan di kalangan para pemimpin dan pihak pembuat keputusan.

Antara matlamat dan tujuan utama penganjuran kempen kesedaran ini adalah seperti berikut:

1. Mendidik dan memaklumkan kepada masyarakat tentang keusahawanan dan pelancongan
 - ✓ Membangunkan objektif untuk pendidikan komuniti mengikut matlamat organisasi dan ciri-ciri masyarakat setempat.
 - ✓ Menilai dan memilih kaedah komunikasi yang sesuai, dan merangka serta melaksanakan strategi dan program untuk memaksimumkan peluang untuk mendidik dan memaklumkan kepada masyarakat mengenai pelancongan.
 - ✓ Mencari peluang secara proaktif untuk menerima pakai pendekatan baru dan inovatif dalam pendidikan komuniti.
 - ✓ Berkommunikasi dengan masyarakat secara berterusan mengenai kesan positif dan negatif pelancongan.
2. Membangunkan rangkaian (*networks*) pihak-pihak berkepentingan
 - ✓ Mengulas dan menilai pihak berkepentingan semasa dan berpotensi dalam menentukan keperluan, minat, keutamaan dan arah aliran yang berkaitan.
 - ✓ Mengenal pasti pihak berkepentingan utama, wakil mereka dan cara-cara untuk mewujudkan dan mengekalkan kesepaduan antara ahli.
 - ✓ Berkongsi kepakaran, maklumat dan sumber dengan rangkaian apabila sesuai bagi mengukuhkan kesepaduan.
 - ✓ Mencadangkan untuk maklumat terkini berkaitan pihak berkepentingan untuk dikumpul dan dikekalkan.

3. Mendapatkan maklum balas daripada pihak berkepentingan
 - ✓ Mendapatkan pandangan dan pendapat daripada pihak berkepentingan mengenai aktiviti pelancongan secara berterusan.
 - ✓ Menilai dan mengintegrasikan input pihak berkepentingan dalam perancangan dan penganjuran aktiviti pelancongan.
 - ✓ Mengenal pasti konflik masyarakat yang berpotensi untuk berlaku dan mencari penyelesaian melalui perundingan dengan pihak yang berkaitan.

KESIMPULAN

Pelancongan merupakan antara sektor ekonomi yang berpotensi membantu masyarakat nelayan memperoleh pendapatan yang konsisten tanpa terlalu bergantung penuh terhadap hasil tangkapan daripada laut. Di sebalik faktor-faktor yang mengganggu-gugat pendapatan nelayan seperti cuaca buruk dan pencemaran laut, sudah tiba masanya untuk masyarakat nelayan diberi pemahaman dan kesedaran bahawa ‘sumber laut’ yang menyumbang kepada pendapatan mereka selama ini adalah tidak bersifat kekal dan berhadapan dengan senario kepupusan atau penyusutan populasi. Jika selama ini agak terlalu banyak bantuan dan sumbangan yang diterima daripada pihak kerajaan atau badan-badan yang tertentu sekiranya pendapatan mereka terjejas, masyarakat nelayan perlu keluar daripada zon selesa ini dan membuat persediaan awal sekiranya segala bentuk bantuan berkenaan dihentikan. Keadaan ini tidak mustahil akan berlaku sebagaimana senario ketidakstabilan ekonomi serantau yang turut diburukkan lagi oleh senario politik semasa negara yang dilihat agak kucar-kacir. Justeru, daripada selesa diberikan ‘ikan’ selama ini, masyarakat nelayan perlu berusaha ‘menggunakan segala bentuk dan cara termasuk menggunakan pancing bagi menangkap ikan’. Dalam hal ini, peluang keusahawanan yang dijana melalui pelancongan perlu direbutguna untuk menambahbaik taraf sosioekonomi masyarakat nelayan. Namun, pembangunan pelancongan perlu dirancang sebaik mungkin dengan memberikan pertimbangan sewajarnya terhadap potensi impak yang bakal tercetus serta pemahaman terhadap ‘ciri-ciri’ pelancongan itu sendiri.

RUJUKAN

- Ahmad, M. Z. (2017). *Sikap dan Persepsi Masyarakat Nelayan terhadap Pembangunan Pelancongan di Kuala Kedah: ke arah Pembangunan Lestari*. (Tesis PhD yang tidak diterbitkan) Universiti Kebangsaan Malaysia, Bangi.
- Allen, L. R., Long, P. T., Perdue, R. R. and Kielselbach, S. (1988). The impacts of tourism development on residents perceptions of community life. *Journal of Travel Research*, 26(1), 16-21.
- Ap, J. (1992). Residents’ perceptions on tourism impacts. *Annals of Tourism Research*, 19(4), 665-690.
- Bjorklund, E. M. and Philbrich, A. K. (1972) *Spatial configurations of mental process*. Unpublished document. Department of Geography, University of Western Ontario.
- Butler, R. W. (1975). Tourism as an agent of social change. *Tourism as a Factor in National and Regional Development* (Occasional Paper), Department of Geography, Trent University.
- Cooke, K. (1982). Guidelines for socially appropriate tourism development in British Columbia. *Journal of Travel Research*, 21(1), 22-28.
- Davis, D., Allen, J. and Cosenza, R. M. (1988). Segmenting local residents by their attitudes, interests and opinions towards tourism. *Journal of Travel Research* 27(2), 2-8.

- Doxey, G. V. (1975). A causation theory of visitor-resident irritants' methodology and research inferences. *Proceedings of the Sixth Annual Conference of Travel Research Association*, San Diego CA.
- Federation of Nature and National Parks of Europe (1993). *Loving them to death? Sustainable tourism in Europe's nature and national parks*. Belgium, FNNPE.
- Garrod, F. and Fyall (1998). Beyond rhetoric of sustainable tourism? *Tourism Management*, 19(3), 199-212.
- Gursoy, D., Jurowski, C. and Uysall, M. (2002). Resident attitudes: a structural modeling approach, *Annals of Tourism Research*, 29, 79-105.
- Huang, Y. and Stewart, W. P. (1996). Rural tourism development: shifting basis of community solidarity. *Journal of Travel Research*, 36(4), 26-31.
- Inskeep, E. (1991). *Tourism planning: an integrated and sustainable development approach*. VanNostrand Reinhold.
- Johnson, J., Snepenger, D. and Akis, S. (1994). Residents' perceptions of tourism development. *Annals of Tourism Research*, 21(3), 629-642.
- Jurowski, C., Uysal, M. and Williams, R. (1997). A theoretical analysis of host community resident reactions to tourism. *Journal of Travel Research*, 36(2), 3-11.
- Ko, D.-W. and Stewart, W. P. (2002). A structural equation model of residents' attitudes for tourism development. *Tourism Management*, 23, 521-530.
- Lankford, S. V. and Howard, D. R. (1994). Developing a tourism impacts attitude scale. *Annals of Tourism Research*, 21(1), 121-139.
- Lembaga Kemajuan Ikan Malaysia (LKIM). *Laporan Tahunan 2014, 2015, 2016, 2017, 2018, 2019 dan 2020*. Diakses dari <https://www.lkim.gov.my/laporan-tahunan>. (28 Ogos 2022).
- Marsh, N. and Henshall, B. D. (1987). Planning better tourism: the strategic importance of tourist-resident expectations and interactions. *Tourism Recreation Research*, 12(2), 47-54.
- Mathieson, A. and Wall, G. (1982). *Tourism: economic, physical and social impacts*. Singapore: Longman Singapore Publishers (Pte) Ltd.
- Perdue, R. R., Long, P. T., and Allen, L. R. (1990). Resident support for tourism development. *Annals of Tourism Research*, 17(4), 586-599.
- Pizam, A. (1978). Tourism impacts: the social costs to the destination community as perceived by its residents. *Journal of Travel Research*, 16(4), 8-12.
- Sheldon, P. J. and Abenoja, T. (2001). Resident attitudes in a mature destination: the case of Waikiki, *Tourism Management*, 22, 435-443.
- Walpole, M. J. and Goodwin, H. J. 2001. "Local attitudes towards conservation and tourism around Komodo National Park, Indonesia", *Environmental Conservation*, Vol. 28 No. 02, pp. 160-166.
- Wang, Y. A. and Pfister, R. E. 2008. "Residents' attitudes toward tourism and perceived personal benefits in a rural community", *Journal of Travel Research*, Vol. 47 No. 1, pp. 84-93.
- Saufi, A., O'Brien, D. and Wilkins, H., 2014. Inhibitors to host community participation in sustainable tourism development in developing countries. *Journal of Sustainable Tourism*, 22(5), pp.801-820.
- Sharpley, R. 1994. *Tourism, Tourists and Society*, ELM Publications, Huntingdon, UK.
- Sharpley, R., 2014. Host perceptions of tourism: A review of the research. *Tourism Management*, 42, pp.37-49.

Kemelut Pendidikan Kanak-Kanak Rohingya: Peranan dan Cabaran Pusat Pembelajaran Alternatif di Pulau Pinang

Aida Zahirah Samsudin

*Research Center for Arabic Language and Islamic Civilization,
Universiti Kebangsaan Malaysia, Bangi, Malaysia.*

aidaazahirah@gmail.com

Napisah Karimah Ismail

*Research Center for Arabic Language and Islamic Civilization,
Universiti Kebangsaan Malaysia, Bangi, Malaysia.*

napisah@ukm.edu.my

ABSTRACT

The issue of Rohingya refugee education in Malaysia is often talked about because they do not have the opportunity to enter the formal education system in Malaysia. It continues from the beginning of their arrival until they enter the third generation and among the steps taken by Non-Governmental Organizations (NGOs) is to establish alternative learning centers to provide educational opportunities for this group. Thus, this study aims to examine the role and challenges faced by alternative learning centers in Penang, one of the states with the largest distribution of Rohingya refugees apart from the Klang Valley. This study uses a qualitative approach with data collection through a semi-structured interview method. Focus group interviews were conducted in three selected study locations, namely Rohingya Education Center Pulau Pinang, LifeBridge Learning Center and Rohingya Community Learning Center Bukit Mertajam. The study found that the learning center's roles are to provide an appropriate curriculum and syllabus, provide exposure related to culture and identity and look after the welfare of Rohingya children. This effort also faces challenges such as a lack of financial resources and limited infrastructure, curriculum and syllabus inconsistency as well as negative perceptions of the local community and the problem of refugee culture. This study suggests that research related to the difficulties faced by learning centers throughout Malaysia be expanded to find solutions to ensure the quality of education for Rohingya children in Malaysia can be improved. The best solution to improve the quality of refugee education will simultaneously help the government and the local community overcome problems related to the refugee group, especially abandoned children who do not receive a proper education.

Keywords: *Rohingya Refugees; Alternative Education; Role of Alternative Learning Centre; Refugees Education; Penang Island.*

ABSTRAK

Isu pendidikan pelarian Rohingya di Malaysia sering diperkatakan berikutan mereka tidak berpeluang memasuki sistem pendidikan formal di Malaysia. Ia berterusan sejak awal kedatangan mereka sehingga memasuki golongan generasi ketiga dan antara langkah yang diambil oleh Organisasi Bukan Kerajaan (NGO) adalah menubuhkan pusat pembelajaran alternatif bagi menyediakan peluang pendidikan kepada golongan ini. Justeru, kajian ini bertujuan mengkaji peranan dan cabaran yang dihadapi oleh pusat pembelajaran alternatif di Pulau Pinang, salah sebuah negeri yang mempunyai taburan pelarian Rohingya teramai selain Lembah Klang. Kajian ini menggunakan pendekatan kualitatif dengan pengumpulan data melalui kaedah temu bual semi-struktur. Temu bual kumpulan fokus telah dijalankan di tiga buah lokasi kajian terpilih iaitu Rohingya Education Centre Pulau Pinang, LifeBridge Learning Centre dan Rohingya Community Learning Centre Bukit Mertajam. Kajian mendapati bahawa antara peranan pusat pembelajaran adalah menyediakan kurikulum dan

silibus yang sesuai, memberi pendedahan berkaitan budaya dan identiti serta menjaga kebajikan kanak-kanak Rohingya. Usaha ini juga berdepan dengan cabaran seperti kekurangan sumber kewangan dan keterbatasan infrastruktur, ketidakselarasan kurikulum dan silibus serta tanggapan negatif masyarakat tempatan dan pemasalahan budaya pelarian. Kajian ini menyarankan agar kajian berkaitan permasalahan yang dihadapi pusat pembelajaran di seluruh Malaysia diperluaskan bagi mencari solusi dalam memastikan kualiti pendidikan kanak-kanak Rohingya di Malaysia dapat ditingkatkan. Solusi terbaik bagi meningkatkan kualiti pendidikan pelarian akan sekaligus membantu pihak kerajaan dan masyarakat setempat dalam mengatasi permasalahan berkaitan dengan golongan pelarian khususnya kanak-kanak yang terbiar dan tidak mendapat pendidikan sewajarnya.

Kata Kunci: *Pelarian Rohingya; Pendidikan Alternatif; Peranan Pusat Pembelajaran Alternatif; Pendidikan Pelarian; Pulau Pinang.*

PENGENALAN

Pelarian Rohingya merupakan kelompok pelarian terbesar di Malaysia. Berdasarkan data yang diperoleh daripada *United Nations High Commission for Refugees* (UNHCR) Malaysia, terdapat anggaran sekitar 183,430 pelarian dan pencari suaka berdaftar dengan agensi antarabangsa ini pada akhir September 2022. Angka tersebut juga menunjukkan majoriti pelarian di Malaysia adalah Rohingya yang terdiri daripada 105,870 orang. Negeri Pulau Pinang merupakan antara taburan terbesar populasi pelarian Rohingya di Malaysia selain Lembah Klang dan Johor (UNHCR Malaysia, 2022). UNHCR mendefinisikan pelarian sebagai orang yang melarikan diri dari peperangan, keganasan, konflik atau penganiayaan dan telah merentasi sempadan antarabangsa demi mencari keselamatan di negara lain.

Bagaimanapun, didapati nasib pelarian Rohingya di Pulau Pinang masih samar dan tidak menentu sebagaimana nasib pelarian lain yang berada di Malaysia berikutan Malaysia tidak meratifikasikan Konvensyen Status Pelarian 1951 dan Protokol 1967. Oleh yang demikian, Malaysia tidak mempunyai sebarang tanggungjawab dan peruntukan untuk memberikan perlindungan terhadap golongan pelarian termasuk aspek pendidikan kanak-kanak pelarian. Malaysia sebagai sebuah negara yang menandatangani *United Nation Convention on the Rights of the Child* (CRC) 1989 sebenarnya mempunyai tanggungjawab untuk memastikan setiap kanak-kanak di Malaysia mendapat pendidikan tanpa mengira status warganegara namun diperingkat pelaksanaan, ia dihalang oleh keterikatan dengan Perlembagaan Malaysia yang tidak mengiktiraf golongan pelarian di bawah Akta Imigresen Malaysia 1959/1963 dan Akta Pendidikan 1996 yang hanya memperuntukkan hak pendidikan untuk warganegara sahaja. Ketiadaan peruntukan ini juga telah menyukarkan kanak-kanak pelarian mendapat pendidikan yang sewajarnya di negara ini (Mohd Nur Hidayat Hasbollah Hajimin & Ibnor Azli Ibrahim, 2017; Nadzira Miskiman & Khalim Zainal, 2019).

Segala bentuk perlindungan untuk pelarian di Malaysia berada di bawah mandat UNHCR di samping mendapat kerjasama daripada kerajaan Malaysia dan Organisasi Bukan Kerajaan (NGO) terutamanya dalam usaha menyediakan sokongan kemanusiaan melalui pendidikan dan penjagaan kesihatan. Data daripada *UNHCR Education Refugees Report 2022* menunjukkan terdapat lebih daripada 10 juta kanak-kanak pelarian dalam usia persekolahan berada di bawah mandat UNHCR termasuk kanak-kanak Rohingya di Malaysia (UNHCR, 2022). Pada tahun 2017, UNHCR Malaysia menganggarkan terdapat seramai 23,838 kanak-kanak pelarian yang berdaftar di Malaysia namun jumlah yang bersekolah hanya sekitar 7,156 orang. Bagaimanapun jumlah ini belum termasuk kanak-kanak pelarian yang tidak berdaftar dengan UNHCR.

Terdapat kajian yang menyatakan keciciran pendidikan dalam kalangan kanak-kanak pelarian Rohingya menyebabkan mereka terperangkap dalam kitaran buta huruf seperti yang dialami oleh generasi mereka terdahulu walaupun fasih berbahasa melayu (Hema Letchamanan, 2013; Intan Suria Hamzah et al., 2020; Tan Pok Suan, 2006). Malah didapati ketiadaan pendidikan ini menjadi faktor kepada peningkatan penglibatan kanak-kanak pelarian dan tanpa warganegara dalam kegiatan jenayah dan masalah sosial di Malaysia. Kecenderungan mereka melakukan jenayah dan kegiatan yang tidak bermoral seperti merokok, menghisap dadah dan gam, melepak, mencuri dan perjudian disebabkan mereka mempunyai banyak masa tanpa melakukan sebarang aktiviti yang berfaedah. Tanpa pendidikan juga menyebabkan mereka mudah ditipu dan dieksploitasi oleh pihak yang tidak bertanggungjawab sebagai mangsa ekonomi (Azizah Kassim, 2009; Mohd Nur Hidayat Hasbollah Hajimin & Iknor Azli Ibrahim, 2017; Nadzira Miskiman & Khalim Zainal, 2019; Sity Daud & Intan Suria Hamzah, 2015).

Maka atas dasar kemanusiaan dan juga langkah menangani masalah sosial dalam kanak-kanak pelarian di Malaysia, mereka tidak dihalang mengikuti sesi persekolahan di pusat pembelajaran alternatif atau pusat pembelajaran komuniti yang disediakan oleh pihak NGO, organisasi berasaskan kepercayaan, individu perseorangan, komuniti pelarian dan yayasan dengan kerjasama UNHCR (*United Nations Children's Fund* (UNICEF), 2015). Walau bagaimanapun, masih terdapat golongan kanak-kanak pelarian Rohingya tidak berpeluang mengikuti pembelajaran ini disebabkan oleh penawaran dan kapasiti yang sangat terhad. Selain itu, kajian oleh Aizat Khairi pada tahun 2019 menjelaskan kebanyakan peluang pendidikan kanak-kanak Rohingya yang disediakan ini hanya di peringkat rendah sahaja dan mereka memerlukan sambungan pendidikan menengah bagi mengembangkan nilai yang dipelajari di pendidikan rendah dan meningkatkan kemahiran literasi dan numerasi mereka selain peluang untuk pendidikan tinggi yang juga dikenali sebagai pendidikan pasca-menengah dan pendidikan tertiar.

Bertitik tolak dari itu, kertas kerja ini memfokuskan kepada aspek pendidikan kanak-kanak pelarian Rohingya di Malaysia khususnya Pulau Pinang dengan melihat kepada peranan dan cabaran yang dihadapi oleh pusat pembelajaran alternatif dalam menyediakan peluang pendidikan yang sewajarnya kepada golongan pelarian ini. Perbincangan dalam kertas kerja ini dapat dibahagikan kepada tiga bahagian utama. Pertama, membincangkan peluang pendidikan untuk kanak-kanak Rohingya di Pulau Pinang. Bahagian kedua membincangkan mengenai peranan pusat pembelajaran alternatif untuk kanak-kanak Rohingya di Pulau Pinang. Seterusnya, bahagian ketiga melihat cabaran yang dihadapi oleh pusat pembelajaran alternatif dalam menguruskan pendidikan kanak-kanak Rohingya di Pulau Pinang.

METODE

Kajian ini dijalankan dengan menggunakan pendekatan kualitatif. Hasil kajian ini diperolehi daripada aktiviti kerja lapangan yang melibatkan pihak pengurusan dan guru pusat pembelajaran alternatif iaitu *Rohingya Education Centre Pulau Pinang (REC)*, *LifeBridge Learning Centre (LLC)* dan *Rohingya Community Learning Centre Bukit Mertajam (RCLC)* pada tahun 2022 yang terletak di Pulau Pinang. Maklumat dikumpul daripada informan dengan menggunakan kaedah temu bual semi-struktur.

DAPATAN DAN PERBINCANGAN

Pendidikan untuk Kanak-Kanak Rohingya di Pulau Pinang

Bagi menguruskan isu pendidikan kanak-kanak Rohingya di Pulau Pinang, terdapat NGO tempatan dan individu perseorangan yang mengambil inisiatif menawarkan pendidikan alternatif kepada kanak-kanak Rohingya seperti *Rohingya Education Centre Pulau Pinang* (REC), *LifeBridge Learning Centre* (LLC) dan *Rohingya Community Learning Centre Bukit Mertajam* (RCLC). Dapatan kajian ini adalah berdasarkan kepada hasil temu bual bersama dengan pihak pengurusan dan guru.

Persatuan Jaringan Islam Global Masa Depan (JREC) yang dahulunya dikenali sebagai *Future Network Global* (FGN) adalah rakan pelaksana UNHCR yang diberi tanggungjawab dan kepercayaan melaksanakan beberapa projek pendidikan sejak tahun 2010. Antara projek penyelidikan yang dikendalikan adalah pusat pembelajaran dan program pampasan guru atau juga dikenali sebagai *Teacher Compensation Program* (TCP). Bagaimanapun, organisasi ini dilihat telah melaksanakan beberapa projek pendidikan sebelum mereka menjadi rakan pelaksana UNHCR iaitu sejak tahun 2006 lagi. Pada ketika itu mereka membantu madrasah yang menyediakan pendidikan Al-Quran dan Fardhu Ain kepada kanak-kanak pelarian Rohingya dari segi sumber pendanaan bagi urusan bayaran elaun guru-guru, sewaan premis dan keperluan asas yang lain. JREC didapati memulakan projek pendidikan melalui penubuhan *Rohingya Education Centre* (REC) pada Julai 2010 di Permatang pauh, Pulau Pinang. Sehingga tahun 2022, direkodkan JREC telah memiliki lima buah sekolah rendah dan sebuah sekolah menengah di seluruh Malaysia iaitu di Pulau Pinang, Pahang, Terengganu dan Selangor dengan jumlah keseluruhan pelajar Rohingya seramai 976 orang dan 50 orang tenaga pengajar.

Kesemua pusat pembelajaran ini diuruskan sepenuhnya oleh JREC di samping menerima bantuan dan peruntukan daripada pelbagai pihak seperti UNHCR, Zakat Pulau Pinang, Majlis Agama Islam Selangor (MAIS) di bawah zakat Al-Riqab serta NGO-NGO lain seperti Angkatan Belia Islam *Malaysia* (ABIM) dan *Wadah Pencerdasan Umat Malaysia* (WADAH). REC Pulau Pinang menawarkan pendidikan di peringkat rendah dan menengah untuk kanak-kanak Rohingya di sekitar kawasan Permatang Pauh. Berikutan penubuhan sekolah menengah REC pada tahun 2019, terdapat dua sesi waktu persekolahan dijalankan iaitu sesi pagi untuk sekolah rendah yang menempatkan 440 orang pelajar dengan 15 orang guru dan sesi petang untuk sekolah menengah yang menempatkan 80 orang dengan lima orang guru.

Seterusnya, Penang Care sebuah organisasi berasaskan kepercayaan bertanggungjawab menguruskan pendidikan untuk kanak-kanak Rohingya di kawasan sekitar Taman Inderawasih, Perai melalui *LifeBridge Learning Centre* (LLC). Bagaimanapun, pusat pembelajaran yang ditubuhkan pada 1 Januari 2011 adalah hasil daripada cetusan idea “*A School for the Urban Poor*” oleh empat orang individu iaitu Pastor Albert Tan dan Meng Eng, Melanie Hurlbut dan Sudhagaran Stanley. Idea ini berjaya dilaksanakan melalui hasil kutipan jualan buku yang bertajuk “*Disappointed by Hope*” yang diterbitkan oleh *Youth With A Mission* (YWAM) dan juga sumbangan derma berjumlah RM5,000. LLC bermula dengan pendaftaran pelajar seramai 52 orang di lot kedai tiga tingkat kemudian mereka berpindah ke lokasi baru lot kedai yang mempunyai empat tingkat berikutan berlakunya penambahan jumlah pelajar. Hingga kini, dicatatkan jumlah pelajar seramai 124 orang dan majoriti daripadanya adalah kanak-kanak pelarian Rohingya serta disokong oleh lima orang guru.

Rohingya Community Learning Centre Bukit Mertajam atau disebut sebagai RCLC diusahakan dan dikendalikan oleh komuniti Rohingya sendiri iaitu Amir Hussein Abu Bakar yang juga merupakan pengerusi *Rohingya Society Malaysia* (RSM) bagi kawasan Bukit Mertajam. Penubuhannya pada tahun 2011 bertitik tolak daripada kesedaran pendidikan untuk

tiga orang anaknya memandangkan beliau juga memiliki Ijazah Sarjana Muda daripada *University of Yangon*, Myanmar selain ketiadaan peluang pendidikan untuk anak-anaknya pada ketika itu. Beliau memulakan operasi sekolah ini dengan enam orang pelajar dan tiga orang guru. Kini, pusat pembelajaran ini mempunyai sekitar 200 orang pelajar dengan sembilan orang guru. Pada awal penubuhan, pusat ini ditempatkan di bangunan surau bekas milik Pertubuhan Kebajikan Islam Malaysia (PERKIM) di Bukit Mertajam sebelum berpindah ke bangunan lot kedai di kawasan berdekatan pada tahun 2015. Kemudian, pada tahun 2020 surau yang diberi nama Ar-Rahman tersebut didaftar dengan Jabatan Hal Ehwal Agama Islam Pulau Pinang (JHEAIPP) untuk kegunaan ibadah dan kegiatan keagamaan masyarakat Rohingya. Pada masa yang sama bangunan surau tersebut turut dijadikan sebagai pusat kegiatan komuniti melaksanakan program seperti penyerahan sumbangan bantuan dan ibadah Qurban. Di samping itu, RCLC turut menggunakan bangunan surau dan kawasan sekitarnya untuk program keagamaan dan Hari Anugerah Kecemerlangan Pelajar .

Peranan Pusat Pembelajaran Alternatif untuk Kanak-Kanak Rohingya di Pulau Pinang

Dapatan kajian mendapati antara peranan pusat pembelajaran alternatif untuk kanak-kanak pelarian Rohingya adalah menyediakan kurikulum dan silibus yang sesuai, pendidikan budaya dan identiti dan kebajikan kanak-kanak Rohingya.

a. Penyediaan kurikulum dan silibus yang sesuai

Kurikulum yang diguna pakai oleh pusat pembelajaran alternatif di Pulau Pinang adalah berdasarkan kepada Kurikulum Kebangsaan walaupun pada dasarnya Kementerian Pendidikan Malaysia (KPM) tidak membenarkan pusat pembelajaran alternatif mengguna pakai Kurikulum Kebangsaan. Kurikulum negara asal sebenarnya menjadi keutamaan bagi golongan kanak-kanak Rohingya sebagai persediaan sekiranya dihantar pulang. Kurikulum Kebangsaan menurut definisi Akta Pendidikan 1996 dan Peraturan-peraturan (Kurikulum Kebangsaan) Pendidikan 1997) bermaksud suatu program pendidikan yang termasuk kurikulum dan kegiatan kokurikulum yang merangkumi semua pengetahuan, kemahiran, norma, nilai, unsur kebudayaan dan kepercayaan untuk membantu perkembangan seseorang murid dengan sepenuhnya dari segi jasmani, rohani, mental dan emosi serta untuk menanam dan mempertingkatkan nilai moral yang diingini dan untuk menyampaikan pengetahuan (Kementerian Pendidikan Malaysia, 2022). Di pihak UNHCR juga telah mengeluarkan satu garis panduan bagi menangani isu kurikulum kanak-kanak pelarian. Pertama, menyediakan guru biasa dan kurikulum biasa supaya dapat mengurangkan kejutan psiko-sosial kanak-kanak akibat daripada perpindahan paksa rela. Kedua, menggunakan kurikulum negara asal sebagai persediaan dihantar pulang. Ketiga, menggunakan kurikulum yang berbeza atau sebahagian subjek digugurkan khususnya untuk pelarian yang berbeza politik dengan negara asal. Keempat, mengajarkan kurikulum dan bahasa utama negara hos jika situasi pelarian berlanjutan di negara tersebut (Action for Rights of Children, 2001).

Kanak-kanak pelarian Rohingya di Pulau Pinang ini diajarkan dengan mata pelajaran asas seperti Bahasa Melayu, Bahasa Inggeris, Matematik, Sains dan Pendidikan Islam. Walau bagaimanapun, menurut temu bual bersama Chin Kin Ngen pada 26 April 2022 yang merupakan seorang guru menyatakan LLC hanya menawarkan mata pelajaran Bahasa Inggeris, Matematik dan Sains manakala bagi mata pelajaran yang bersifat keagamaan dan Bahasa Melayu tidak ditawarkan kepada kanak-kanak pelarian Rohingya. Mereka sangat menitikberatkan pertuturan dalam Bahasa Inggeris sewaktu di dalam kelas sebagai usaha meningkatkan penguasaan Bahasa Inggeris dan persediaan mereka ke negara ketiga. Sementara temu bual bersama guru besar REC Pulau Pinang yang bernama Nasriah Awang pada 11 Mei

2022 menyatakan terdapat penambahan mata pelajaran di REC khususnya sekolah menengah seperti Sejarah, Pendidikan Seni dan Pendidikan Jasmani selain kelas kemahiran menjahit. Kelas kemahiran yang ditawarkan ini sedikit sebanyak mampu meningkatkan kehidupan mereka selepas tamat persekolahan di REC. Selain itu, bagi meningkatkan kualiti pendidikan kanak-kanak pelarian Rohingya, setiap pusat pembelajaran alternatif ini dilihat meletakkan syarat kelayakan akademik iaitu diploma dan ke atas bagi memenuhi jawatan guru di pusat pembelajaran mereka.

b. Pendidikan budaya dan identiti

Bagi mengekalkan identiti kanak-kanak Rohingya, terdapat pusat pembelajaran yang menggunakan Bahasa Rohingya semasa proses *pengajaran dan pembelajaran dijalankan memandangkan sebahagian guru yang mengajar di sekolah tersebut terdiri daripada etnik mereka sendiri*. Data ini diperoleh daripada temu bual bersama Norlela Harun pada 10 Mei 2022 yang menyatakan bahawa tenaga guru di RCLC terdiri daripada warganegara Malaysia dan etnik Rohingya. Mereka menggunakan pendekatan pengajaran dalam bahasa masing-masing di mana guru Rohingya mengajar dalam Bahasa Rohingya dan guru Malaysia mengajar dalam Bahasa Melayu kecuali kelas Bahasa Inggeris. Langkah ini dilakukan bagi memastikan penyampaian pengajaran yang berkesan.

Tenaga pengajar di pusat pembelajaran alternatif bukan sahaja memberikan pendidikan akademik malah turut memberikan kesedaran berkaitan penjagaan kebersihan diri dan persekitaran dalam kalangan kanak-kanak Rohingya. Hal demikian kerana kehidupan masyarakat Rohingya di Malaysia terikat dengan adat dan budayanya yang tersendiri. Misalnya, kanak-kanak perempuan Rohingya hanya mempraktikkan amalan mandi bunga semasa haid dan hal ini jelas menunjukkan bahawa ilmu berkaitan penjagaan kebersihan diri ketika haid berada di tahap rendah. Oleh yang demikian, menjadi tanggungjawab guru-guru untuk memberi pendedahan berkaitan pengurusan kebersihan diri ketika haid supaya dapat mengawal bau badan mereka. Guru-guru juga memberikan kesedaran berkaitan kebersihan diri sebagaimana Islam menitikberatkan soal kebersihan bagi mewujudkan suasana yang selesa di dalam semua keadaan di samping mengajarkan tatacara mandi wajib seperti yang dituntut dalam Islam (Nasriyah Awang, Mei 11, 2022 dan Nur Azlina Abdul Aziz, Ogos 19, 2022).

c. Kebajikan kanak-kanak Rohingya

Bagi mengurangkan kadar ketidakhadiran kanak-kanak Rohingya ke sekolah dan memudahkan pergerakan mereka pergi dan balik dari sekolah, pihak pusat pembelajaran alternatif menyediakan kemudahan van dan bas untuk kanak-kanak pelarian Rohingya di Pulau Pinang. Kemudahan yang disediakan ini juga sebenarnya membantu mengurangkan bebanan ibu bapa mereka untuk menghantar dan mengambil anak mereka pulang dari sekolah terutamanya bagi mereka yang tiada kenderaan dan lokasi sekolah yang jauh dari penempatan mereka. Bagi para pelajar sekolah menengah REC pula mereka menggunakan perkhidmatan pengangkutan awam untuk datang dan pulang dari sekolah di samping mendapat bantuan dalam bentuk wang ringgit daripada UNHCR bagi menampung kos tambang pengangkutan mereka. Bayaran dibuat secara bulanan sama ada sebulan sekali atau tiga bulan sekali dan jumlah yang diterima berdasarkan kepada kekerapan mereka menghadiri sekolah. Data ini diperoleh daripada sumber temu bual bersama Nasriyah Awang (Mei 11, 2022):

Kalau hujung bulan ada rezeki, UNHCR akan beri duit *transportation* ikutlah kalau tambang bas kira dengan berapa hari dia datang sekolah. UN akan bayar duit pengangkutan kat dia kalau dia kerap mai sekolah dapatlah duit banyak. kadang dia bayar tiga bulan sekali ikutlah. UN akan beri pada JREC *office*. Lepa

akan hantar kat saya, kemudian saya akan agihkan lah kepada pelajar pelajar. Kalau pelajar ada 80 kan, paling jauh Nibong Tebal sebulan dia dapat 100 lebihlah kalau yang lain *average* dalam 40 ringgit je lah.

Penyediaan makanan kepada kanak-kanak Rohingya di pusat pembelajaran alternatif berdasarkan kepada sumber dana dan bayaran yuran pelajar. Misalnya, sekolah rendah REC dan LLC menyediakan makanan sekali sehari kepada para pelajar. Namun bagi RCLC, mereka tidak menyediakan makanan kepada para pelajar berikutan kekurangan sumber dana yang berterusan. Selain itu, dalam usaha untuk memastikan semua pelajar tidak ketinggalan dalam mengikuti pembelajaran sewaktu Perintah Kawalan Pergerakan (PKP) dilaksanakan Ketika penularan Covid-19, pihak UNHCR mengambil inisiatif menyumbangkan sebanyak 3000 unit peranti tablet beserta pelan data internet kepada kanak-kanak pelarian di pusat-pusat pembelajaran alternatif di Malaysia tidak terkecuali pusat pembelajaran di Pulau Pinang.

Cabaran Pengurusan Pusat Pembelajaran Alternatif di Pulau Pinang

Kajian ini menemui tiga cabaran utama yang dihadapi oleh pihak pengurusan pusat pembelajaran alternatif dalam menawarkan pendidikan kepada kanak-kanak pelarian Rohingya seperti sumber dana dan keterbatasan infrastruktur, kurikulum dan silibus yang tidak selaras serta tanggapan negatif masyarakat tempatan dan pemasalahan budaya pelarian.

a. Sumber dana dan keterbatasan infrastruktur

Pemasalahan berkaitan sumber dana dalam pengoperasian sesebuah pusat pembelajaran alternatif di Malaysia bukan suatu perkara yang luar biasa. Maka didapati pusat pembelajaran di Pulau Pinang tidak terkecuali berdepan dengan cabaran kekurangan peruntukan dana yang berterusan bagi memastikan pengekalan pengoperasian. Sumber daripada temu bual dengan Amir Hussein Abu Bakar pada 10 Mei 2022 mendapati bahawa ibu bapa pelarian Rohingya kurang memberi komitmen yang sepenuhnya untuk membayar yuran bulanan persekolahan anak-anak mereka. Bagaimanapun yuran yang dikenakan bagi setiap pusat pembelajaran berbeza-beza di antara RM 30 hingga RM 100 malah kutipan yuran tersebut sebenarnya tidak mampu menampung jumlah keseluruhan perbelanjaan bulanan pusat pembelajaran. Tambahan pula, terdapat pusat pembelajaran yang hanya mengenakan bayaran tersebut sebagai yuran komitmen sahaja dan kemudian disalurkan semula kepada para pelajar melalui penyediaan makanan pada waktu rehat, pengangkutan dan keperluan lain. Dalam pada itu, ibu bapa juga dilihat seolah-olah mengambil kesempatan untuk tidak membayar yuran anak-anak berikutan tiada tindakan yang dikenakan oleh pihak pusat pembelajaran disebabkan memikirkan kesusahan hidup mereka di Malaysia.

Selain itu, pihak LLC terpaksa mengadakan ujian kemasukan ke sekolah mereka disebabkan pemohonan kemasukan pelajar yang terlalu ramai. Jumlah pengambilan pelajar baru perlu dihadkan berdasarkan kepada kekosongan tempat di dalam bilik darjah berikutan keluasan ruang bilik darjah yang terhad untuk memuatkan kerusi dan meja tambahan. Sekiranya ruang bilik darjah terlalu sempit ia akan mengganggu tahap penumpuan pelajar semasa proses pengajaran dan pembelajaran dijalankan selain menyukarkan pergerakan murid dan guru di dalam bilik darjah. Persekitaran ruang kelas yang teratur dan kondusif mempengaruhi keberkesanan aktiviti pengajaran dan pembelajaran. Pada masa yang sama, kajian ini juga mendapati kebanyakan pusat pembelajaran ini terpaksa berpindah ke lokasi baru yang lebih besar dan selesa dengan kadar sewaan bangunan yang lebih tinggi ekoran daripada berlakunya penambahan jumlah kanak-kanak Rohingya dari tahun ke tahun.

b. Kurikulum dan silibus tidak selaras

Maklumat yang diperoleh daripada sumber temu bual dengan Pengarah Eksekutif JREC bernama Nur Azlina binti Abdul Aziz pada 19 Ogos 2022. Pilihan menggunakan Kurikulum Kebangsaan di REC disebabkan kekangan yang dihadapi oleh pihak JREC untuk mendapatkan tenaga pengajar yang mahir berkaitan standard kurikulum di Myanmar dan sekiranya ingin mengharapkan tenaga pengajar dalam kalangan pelarian Rohingya sendiri, kebanyakan daripada mereka tidak mempunyai sebarang kelayakan akademik walaupun persekolahan rendah. Malahan, di luar kemampuan pihak JREC untuk membentuk sendiri modul pendidikan untuk kanak-kanak pelarian Rohingya. Berdasarkan kepada hasil daripada perbincangan pihak JREC bersama UNHCR, terdapat dua pilihan dalam penawaran kurikulum di pusat pembelajaran iaitu berdasarkan kepada kurikulum *International General Certificate of Secondary Education* (IGCSE) atau juga disebut Cambridge IGCSE dan Kurikulum Kebangsaan. Bagaimanapun, terdapat kekangan dari segi peruntukan kewangan sekiranya ingin menawarkan IGCSE kepada kanak-kanak Rohingya disebabkan kos yang terlalu tinggi selain kekurangan tenaga pengajar yang berkelayakan untuk mengajar kurikulum ini. Maka pilihan yang ada hanyalah Kurikulum Kebangsaan dan kemudiannya diubah suai mengikut tahap penguasaan dan pencapaian kanak-kanak pelarian Rohingya. Perkara seperti ini bukan sahaja berlaku di REC bahkan juga pusat-pusat pembelajaran yang lain di Malaysia.

Walaupun kebanyakan pusat pembelajaran menerima pakai Kurikulum Kebangsaan untuk para pelajar namun tetap wujud ketidakselarasan dalam aspek kurikulum dan silibus di antara pusat-pusat pembelajaran pelarian di Malaysia. Didapati silibus pengajaran di setiap pusat pembelajaran berbeza-beza mengikut guru yang mengajar di samping bahan mengajar yang digunakan juga berbeza mengikut pilihan dan cita rasa guru tersebut dan dibeli di kedai-kedai buku. Kurikulum dan silibus di pusat pembelajaran ini juga tiada pantauan dan garis panduan yang jelas dari mana-mana pihak berautoriti termasuk UNHCR. Berdasarkan maklumat daripada Chin Kin Ngen (April 26, 2022) yang telah bertugas selama 11 tahun di LLC, beliau pernah memberi cadangan kepada UNHCR berkaitan pembinaan dan pembentukan kurikulum yang berkesan serta boleh digunapakai oleh semua pusat pembelajaran alternatif di Malaysia selain mewujudkan satu peperiksaan yang khusus kepada kanak-kanak pelarian dengan menyediakan set soalan peperiksaan yang sama. Hal ini dikatakan demikian kerana peperiksaan merupakan medium penilaian utama untuk menilai pencapaian seseorang murid. Cadangan beliau mendapat respon yang baik daripada pihak UNHCR namun sehingga kini belum diimplementasikan. Sementara itu, kebanyakan sistem pendidikan di pusat pembelajaran alternatif tidak mengikut umur yang tepat seperti yang diamalkan di sekolah kerajaan Malaysia disebabkan penilaiannya berdasarkan kepada tahap prestasi dan penguasaan kemahiran membaca, menulis dan mengira.

c. Tanggapan negatif masyarakat tempatan dan pemasalahan budaya pelarian

Pusat pembelajaran sering mendapat pertikaian daripada masyarakat tempatan berkaitan peluang pendidikan yang disediakan kepada kanak-kanak pelarian Rohingya. Hal ini wujud akibat daripada penglibatan sesetengah masyarakat Rohingya dalam masalah sosial dan jenayah sehingga menimbulkan tanggapan negatif segelintir masyarakat Malaysia terhadap keseluruhan masyarakat mereka. Berdasarkan temu bual bersama Nur Azlin Abdul Aziz (Ogos 19, 2022) menyatakan sentimen masyarakat Malaysia yang dipengaruhi oleh pemikiran negatif sedikit sebanyak membantutkan ikhtiar pihak-pihak NGO membantu golongan pelarian. Mereka juga sering mendapat kutukan, kecaman dan maki hamun melalui hantaran yang dimuatnaik di aplikasi media sosial seperti Facebook berkaitan bantuan untuk masyarakat

Rohingya. Namun pendekatan yang diambil oleh mereka adalah dengan berdiam diri tanpa memberi sebarang respon.

Pihak pengurusan bukan sahaja berdepan dengan cabaran menyediakan pendidikan kepada kanak-kanak pelarian bahkan juga pendidikan untuk ibu bapa mereka khususnya dalam aspek pemahaman dan penghayatan agama. Pendidikan juga mampu mengubah pemikiran dan gaya hidup ibu bapa Rohingya yang biasanya dipengaruhi oleh budaya mereka. Contohnya pemikiran ibu bapa Rohingya terhadap anak-anak perempuan yang telah akil baligh dan datang haid tidak perlu lagi ke sekolah. Ibu bapa mereka bertindak memberhentikan persekolahan anak-anak walaupun pihak pengurusan dan guru berusaha memujuk mereka untuk meneruskan pembelajaran anak-anak. Namun keputusannya tetap sama iaitu memberhentikan anak-anak perempuan mereka berikutan bimbang keselamatan sosial sewaktu pergi dan pulang dari sekolah bahkan mereka juga bertindak mengahwinkan anak mereka pada usia yang muda. Dengan keadaan sedemikian menyebabkan kecenderungan kanak-kanak perempuan Rohingya kehilangan pendidikan sebelum sempat menghabiskan persekolahan rendah. Justeru, inisiatif memberikan pendidikan kepada golongan ibu bapa Rohingya memerlukan sokongan dan dokongan daripada pelbagai pihak supaya usaha berskala besar ini dapat digerakkan bagi membentuk pemikiran masyarakat pelarian yang bersedia untuk berubah dan memajukan diri bukan lagi menjadi masyarakat yang menerima dan meminta-minta (Nasriyah Awang, Mei 11, 2022 dan Nur Azlina Abdul Aziz, Ogos 19, 2022).

KESIMPULAN

Kertas kerja ini telah berjaya membincangkan dua objektif yang dibentangkan berkaitan pendidikan kanak-kanak Rohingya di Pulau Pinang. Pertama, mengenai peranan yang dimainkan oleh pusat pembelajaran alternatif untuk kanak-kanak Rohingya di Pulau Pinang misalnya penyediaan kurikulum dan silibus yang sesuai, pendidikan budaya dan identiti dan kebajikan kanak-kanak Rohingya. Kedua, cabaran yang dihadapi oleh pusat pembelajaran alternatif dalam menguruskan pendidikan kanak-kanak Rohingya di Pulau Pinang seperti sumber dana dan keterbatasan infrastruktur, kurikulum dan silibus yang tidak selaras serta tanggapan negatif masyarakat tempatan dan pemasalahan budaya pelarian. Kajian yang dijalankan ini boleh dijadikan salah satu sampel bagi meneruskan kajian terhadap pusat pembelajaran alternatif yang dikhaskan untuk kanak-kanak Rohingya yang lain di seluruh Malaysia dalam mencari permasalahan dan solusi segera agar golongan ini berupaya memperoleh pendidikan yang berkualiti. Diharapkan kajian ini juga mampu memberi input kepada pihak tertentu yang berperanan dalam memperkasakan dan meningkatkan kualiti pendidikan kanak-kanak Rohingya di Malaysia.

PENGHARGAAN

Kajian ini ditaja oleh skim geran penyelidikan fundamental (FRGS) (FRGS/1/2021/SS0/UKM/03/1) Model Penyelidikan Kanak-Kanak dan Remaja golongan pelarian Rohingya di Malaysia.

RUJUKAN

- Action for Rights of Children. (2001). *Critical Issues - Education*. Retrieved October 21, 2022, from [https://www.unhcr.org/en-my/protection/children/3bb821334/action-rights-children-arc-critical-issues-education.html?query=Action for the Rights of Children](https://www.unhcr.org/en-my/protection/children/3bb821334/action-rights-children-arc-critical-issues-education.html?query=Action%20for%20the%20Rights%20of%20Children)
- Aizat Khairi. (2019). From Academia to NGO: The role of REPUSM in providing alternative education for Rohingya refugees' children in Penang Island. *International Journal of*

- Innovative Technology and Exploring Engineering (IJITEE)*, 8(12), 5596–5599.
- Azizah Kassim. (2009). Filipino refugees in Sabah: State responses, public stereotypes and the dilemma over their future. *Southeast Asian Studies*, 47(1), 52–88.
- Hema Letchamanan. (2013). Myanmar's Rohingya refugees in Malaysia: Education and the way forward. *Journal of International and Comparative Educational*, 2(2), 86–97.
- Intan Suria Hamzah, Sity Daud, & Nor Azizan Idris. (2020). *Pendatang Asing Myanmar dan Keselamatan Insan di Malaysia*. Penerbit UKM.
- Kementerian Pendidikan Malaysia. (2022). *Kurikulum Kebangsaan*. Retrieved October 20, 2022, from <https://www.moe.gov.my/index.php/dasarmenu/kurikulum-kebangsaan>
- Mohd Nur Hidayat Hasbollah Hajimin, & Ibnor Azli Ibrahim. (2017). Hak dan perlindungan pelarian Muslim Filipina menurut syariah dan undang-undang Malaysia: Kajian di Negeri Sabah. *Jurnal Hadhari*, 9(2), 193–206.
- Nadzira Miskiman, & Khalim Zainal. (2019). Cabaran dan limitasi pendidikan untuk kanak-kanak tanpa warganegara di Pulau Mabul, Semporna, Sabah. *Proceeding International Conference on Business, Education, Innovation & Social Sciences (ICBEISS 2019)*, 382–391.
- Sity Daud, & Intan Suria Hamzah. (2015). Pendatang Asing Tanpa Izin (PATI) Myanmar di Malaysia: Satu Tinjauan Awal. In Zarina Othman & Nor Azizan Idris (Eds.), *Migrasi dan Keselamatan* (pp. 77–101). Dewan Bahasa dan Pustaka.
- Tan Pok Suan. (2006). Kehidupan Rohingya di Malaysia: Perjuangan dalam ketidakpastian hidup. *Akademika*, 68(1), 111–122.
- UNHCR. (2022). *The campaign for refugee education*. Retrieved October 16, 2022, from <https://www.unhcr.org/en-us/publications/education/631ef5a84/unhcr-education-report-2022-inclusive-campaign-refugee-education.html>
- UNHCR Malaysia. (2022). *Figures at a Glance in Malaysia*. Retrieved October 15, 2022, from <https://www.unhcr.org/en-my/figures-at-a-glance-in-malaysia.html>
- UNICEF. (2015). *Mapping alternative learning approaches, programmes and stakeholders in Malaysia*. Retrieved October 16, 2022, from https://www.unicef.org/malaysia/Mapping_Alternative_Learning_Report.pdf

Muzik Sebagai Terapi Masalah Kesihatan Mental: Suatu Penelitian Terhadap Sumbangan Sarjana Islam Abad Pertengahan

Siti Nur Adilah Awang
Insitut Islam Hadhari, University Kebangsaan Malaysia
sitinuradilah07@gmail.com

Ermy Azziaty Rozali
Insitut Islam Hadhari, University Kebangsaan Malaysia
ermy@ukm.edu.my

Roziyah Sidik @ Mat Sidek
Insitut Islam Hadhari, University Kebangsaan Malaysia
roziyah@ukm.edu.my

ABSTRAK

Penjagaan kesihatan mental sangat dituntut dalam ajaran Islam supaya setiap umatnya mampu untuk melaksanakan tanggungjawab sebagai seorang Muslim dan anggota masyarakat yang lebih bermakna. Malahan, umat Islam yang mengalami masalah kesihatan mental juga disarankan untuk berikhtiar bagi mendapatkan rawatan dan pemulihan. Salah satu kaedah untuk merawat masalah kesihatan mental yang terdapat dalam perubatan tamadun Islam abad pertengahan adalah melalui intervensi terapi muzik. Justeru, kajian ini dijalankan bagi mengkaji perkembangan seni muzik dalam tamadun Islam abad pertengahan di samping menganalisis sumbangan para sarjana Islam dalam membangunkan falsafah terapi muzik. Kajian ini menggunakan kaedah kualitatif dengan pendekatan reka bentuk kajian sejarah berpandukan pelbagai sumber berautoriti dan seterusnya dianalisis menggunakan kaedah analisis teks serta deduktif. Hasil kajian ini mendapati terapi muzik dalam tamadun Islam berkembang secara pesat bermula era kerajaan Abbasiyyah. Ianya dibangunkan oleh para sarjana Islam menerusi aktiviti penterjemahan dan penyelidikan secara mendalam terhadap karya-karya dari tamadun silam khususnya tamadun Greek. Antara sarjana terkemuka abad pertengahan Islam yang mempelopori bidang falsafah terapi muzik seperti al-Kindi, al-Razi, al-Farabi dan Ibn Sina. Usaha para sarjana-sarjan ini telah menyumbangkan pelbagai manuskrip dan karya klasik yang membincangkan mengenai falsafah terapi muzik dalam tamadun Islam seperti Kitab al-Mansuri Fi al-Tibb, Kitab al-Musiqa al-Kabir dan al-Qanun fi al-Tibb.

Keywords: Muzik; Terapi Muzik; Masalah Kesihatan Mental; Sarjana Tamadun Islam; Sejarah Perubatan Islam.

ABSTRACT

Islam strongly promotes mental health care so that all adherents are able to carry out their responsibilities as a Muslim and a more meaningful member of society. Muslims with mental health problems are also advised to strive for treatment and rehabilitation. One of the methods of treating mental health problems found in the medicine of medieval Islamic civilization is through the intervention of music therapy. Thus, this study was conducted to study the development of music therapy in medieval Islamic civilization as well as to analyze the contribution of Islamic scholars in developing philosophy of music therapy. This study uses a qualitative method with a historical study design approach guided by various authoritative sources and subsequently analyzed using text and deductive analysis methods. The results of this study found that music therapy in Islamic civilization developed rapidly beginning in the era of the Abbasiyyah period. It was developed by Islamic scholars through translation

activities and in-depth research on works from ancient civilizations, especially Greek civilizations. Among the leading scholars of medieval Islam who pioneered the philosophy of music therapy such as al-Kindi, al-Razi, al-Farabi and Ibn Sina. The efforts of these scholars have contributed various manuscripts and classical works that discuss the philosophy of music therapy in Islamic civilization such as Kitab al-Mansuri Fi al-Tibb, Kitab al-Musiqa al-Kabir and al-Qanun fi al-Tibb.

Keywords: *Music; Music Therapy; Mental Health Problems; Islamic Civilization Medicine; Scholar of Islamic Civilization.*

PENGENALAN

Masalah kesihatan mental merupakan antara penyakit yang sering dihadapi dalam kalangan masyarakat malahan menunjukkan trend peningkatan di seluruh dunia termasuklah di Malaysia. Pertubuhan Kesihatan Sedunia (WHO) melaporkan bahawa kadar kemurungan dan depresi pasca pandemik COVID-19 meningkat pada kadar 25 peratus iaitu pertambahan hampir satu billion yang mengalami masalah gangguan kesihatan mental (Noor Atiqah, 2022). Salah satu pendekatan yang boleh digunakan pada masa kini bagi membendung dan merawat masalah kesihatan mental adalah melalui terapi muzik. kaedah ini telah dikemukakan dalam kajian-kajian oleh Hsu dan Lai (2004), Dobrzynska et al. (2006), Dewi (2009), Stuckey (2010), Goyal et al. (2012), Sabry & Vohra (2013), Zincir et al. (2014), Raglio et al. (2015), Rahshenas et al. (2015), Torres et al. (2016), Izaida (2018), Atiyah dan Siti Maryam (2018), Wang dan Agius (2018), Tang et al. (2020) dan Golden et al. (2021).

Menyoroti sejarah seni muzik dalam tamadun Islam abad pertengahan, ternyata terapi muzik pernah digunakan sebagai rawatan dalam menangani masalah kesihatan mental. Ianya dikatakan sedemikian kerana pada abad pertengahan iaitu bermula abad ke-9M, terdapat sejumlah karya Islam klasik berkaitan kepentingan muzik kepada kesihatan dan jiwa manusia (Isgandarova, 2015). Nama-nama sarjana terawal dan terkemuka yang menyumbang kepada pengasasan doktrin dan penulisan karya terapi muzik telah dikemukakan dalam kajian oleh Saoud (2004), Sabry & Vohra (2013), Zincir et al. (2014), Isgandarova (2015), Siti Norhidayah & Roziah (2017), Sarhan (2018), Mohd Jailani (2019; 2020), Awaad et al. (2021), dan Muhammad Asyraf dan Kamal (2021). Kajian-kajian tersebut menyenaraikan lima nama sarjana terkemuka yang mengkaji muzik sebagai satu cabang falsafah dan matematik iaitu al-Kindi, al-Razi, al-Farabi dan Ibn Sina. Justeru, satu pengkajian terhadap sejarah perkembangan dan sumbangan tokoh-tokoh sarjana Islam dalam pembangunan falsafah terapi muzik wajar dilakukan.

METODOLOGI KAJIAN

Sebagai panduan untuk mendapatkan hasil kajian, penulis menggunakan reka bentuk kajian kualitatif dengan pendekatan kajian sejarah dan analisis kandungan. Melalui metode kajian sejarah, penulis telah mengumpulkan maklumat dan data tekstual berkaitan biografi dan sumbangan tokoh sarjana Islam abad pertengahan dalam bidang terapi muzik daripada pelbagai sumber dan rujukan. Rujukan dalam kajian ini adalah meliputi buku, artikel, jurnal, ensiklopedia, kajian-kajian lepas dan laman sesawang yang berautoriti. Selain itu, kaedah analisis kandungan juga turut digunakan bagi mengekstrak maklumat dan data yang dikumpulkan bertujuan untuk mendapatkan maklumat yang paling tepat bagi kajian ini. Untuk menganalisis maklumat secara bersistematik pula, dua kaedah analisis telah digunakan iaitu analisis berbentuk tematik teks dan juga analisis melalui kaedah deduktif. Justeru, kaedah analisis tematik dan deduktif adalah paling sesuai diaplikasikan dalam kajian ini bagi tujuan

pengumpulan data secara bersistematik dan berkesan, mengelakkan dari kekeliruan data dan juga memudahkan proses analisis maklumat.

DAPATAN KAJIAN

Hasil dapatan dan perbincangan dalam kajian ini akan menumpukan kepada dua perbahasan utama sahaja iaitu sejarah perkembangan terapi muzik dalam tamadun Islam abad pertengahan serta sumbangan tokoh-tokoh sarjana Islam abad pertengahan dalam falsafah terapi muzik.

Sejarah Perkembangan Terapi Muzik dalam Tamadun Islam Abad Pertengahan

Secara umumnya, seni muzik dalam tamadun Islam berkembang sekitar era pemerintahan Khulafa' al-Rashidin dan Banu Umayyah. Menurut Siti Norhidayah & Roziah (2016), muzik pada ketika itu dikembangkan oleh ribuan hamba serta tawanan-tawanan yang mempunyai bakat dalam seni seperti penyair dan ahli muzik bagi tujuan hiburan. Terdapat juga beberapa sarjana yang memperkenalkan ilmu muzik melalui penghasilan karya-karya penulisan antaranya seperti al-Isfahani, Sa'ib Kathir (683M), Tuways (710M) dan Ibn Mijjah (705-714M). Pada era pemerintahan kerajaan Abbasiyyah, muzik dalam kerajaan Abbasiyyah berkembang pesat bukan hanya sebagai medium hiburan semata-mata, akan tetapi juga turut dikaji sebagai suatu cabang ilmu falsafah dan matematik (Siti Norhidayah & Roziah 2016).

Penerokaan terhadap seni muzik dalam kerajaan Abbasiyyah semakin rancak apabila tamadun Islam berjaya mendapatkan sejumlah besar karya saintifik dari tamadun Greek seperti Pythagoras, Aristotle dan Plato menerusi misi penaklukan wilayah yang besar dari semenanjung Iberia ke Turkmenistan Timur. Sekitar abad ke-9M sehingga abad ke-10M, sejumlah besar karya-karya intelektual tamadun Greek telah diterjemahkan ke bahasa Arab dan Syria oleh para sarjana dengan sokongan dan galakan penuh dari para pemimpin atasan (Shiloah, 1993). Pandangan sarjana Greek berkenaan falsafah muzik diserap ke dalam tamadun dan diadun semula menurut acuan yang menepati ajaran Islam kerana bercampur aduk dengan amalan paganism (Saoud, 2004).

Antara judul karya Greek berkaitan dengan muzik yang telah melalui proses penterjemahan adalah seperti *Manuale Harmonica* oleh Nicomachus kepada (*Kitab al-Musiqat al-Kabir*), *Harmonics* oleh Ptolemy (*Kitab al-Musiqat*), *De voce* oleh Galen dengan judul *Kitab al-Sawt* (Mohd Jailani 2019). Karya-karya terjemahan disebarkan ke seluruh wilayah Islam terutamanya pusat-pusat keilmuan utama seperti Kaherah, Toledo, Bukhara dan Samarkhand dan kemudiannya menjadi inspirasi dan rujukan kepada para sarjana Islam untuk membangunkan pelbagai falsafah sains mengikut prinsip Islam (Pacholczyk 1996). Usaha menterjemah dan menggali semula khazanah ilmu muzik Greek telah melahirkan pengetahuan muzik sebagai satu cabang ilmu falsafah baru malahan juga menjadi asas kepada perkembangan falsafah terapi muzik dalam tamadun Islam (Shiloah, 1993).

Menurut Mohd Jailani (2019), prinsip asas yang mendasari falsafah terapi muzik dalam tamadun Islam adalah berteraskan kepada prinsip patologi humoral dari tamadun Greek. Prinsip patologi humoral merupakan teori perubatan yang dikembangkan oleh ahli falsafah Greek iaitu Aristotle. Prinsip ini mengemukakan bahawa tubuh manusia mempunyai empat humor iaitu darah, hempedu kuning, hempedu hitam dan kahak. Humor ini dianggap sepadan dengan empat unsur kosmik iaitu bumi, udara, api dan air dan empat kualiti jirim iaitu panas, kekeringan, lembapan dan sejuk. Humoral harus berada dalam keseimbangan yang optimum dan ketidakseimbangan dalam badan yang disebabkan oleh sama ada berlebihan atau kekurangan humor akan menyebabkan tercetusnya penyakit. Menerusi pemahaman inilah pelbagai karya saintifik telah dihasilkan oleh sarjana-sarjana tamadun Islam semenjak daripada abad 9M sehinggalah abad ke-16M mengenai doktrin terapi muzik.

Sumbangan Tokoh Sarjana Islam abad Pertengahan dalam Falsafah Terapi Muzik

Penggalian semula khazanah tamadun Greek telah melahirkan sebilangan besar tokoh-tokoh sarjana Islam yang kompeten dalam bidang muzik. Antara tokoh-tokoh sarjana yang banyak menyumbang dalam membangunkan falsafah terapi muzik ialah al-Kindi (801M-873M), al-Razi (854M-932M), al-Farabi (870M-950M), Ibnu Sina (980M-1037M) dan Ikhwan al-Safa'. Berikut merupakan antara latar belakang sarjana dan karya terapi muzik yang dalam tamadun Islam sebelum kerajaan Uthmaniyyah:

Al-Kindi

Al-Kindi atau nama sebenar Abu Yusuf Ya'qub ibn 'Ishaq al-Ṣabbāh al-Kindi (801-873M) merupakan seorang ahli falsafah dan doktor berketurunan Arab. Menurut Shiloah (1995), beliau merupakan sarjana Islam perintis dalam penyelidikan bidang muzik secara saintifik iaitu sekitar pertengahan abad ke-9M. Dalam memahami falsafah muzik ini, al-Kindi berpegang kepada falsafah Aristotle iaitu muzik mempunyai kaitan dengan manusia dan kosmologi melalui unsur bumi iaitu air, udara, api dan tanah. Al-Kindi menulis hampir sepuluh buah buku berkenaan muzik iaitu *Kitab al-A'zam i al-Talif*, *Risalah isabi al-Zamaniyya*, *Risalah i Sina'ati al-Akvali al-Adediyyah*, *Muhtasar al-Musiqa i Te'lif al-Nagham wa San'at al-Ud*, *Risalah i alMadkhal ila Sina't al-Musiqa*; *Risala i Qismat al-Qanun*, *Risalah i Hubr Sina'ar al-Telif*, *Kitab al-Musawwitat al-Watariyya min Zat al-Watar al-Vahid ila Zat al-Ashrat al-Autar*, *Risala i al-Lahun wa al-Magham* dan *Risalah i Ejza Hubriyya i al-Musiqa* (Isgandarova 2015).

Al-Kindi banyak menghubungkan teori berkenaan muzik dan perubatan. Antaranya, al-Kindi berpandangan bahawa irama dan melodi haruslah seiring. Misalnya, sesebuah irama yang agak berat tetapi perlahan sangat sesuai dengan melodi sedih dan perasaan murung. Begitu pula sebaliknya apabila irama itu agak ringan tetapi cepat maka ia sesuai disepadankan dengan melodi sederhana (Mohd Jailani & Roziah 2016). Al-Kindi juga mendapati bahawa gubahan muzik yang betul mampu menjadi penawar kepada ketidakseimbangan humor dalam badan manusia (Mohd Jailani et al. 2019). Selain itu, al-Kindi juga turut melihat muzik sebagai sebuah mekanisme yang boleh dijadikan medium untuk memupuk nilai-nilai moral seperti ketenangan jiwa, empati dan toleransi. Muzik juga boleh digunakan untuk mencapai kesejahteraan dan kebahagiaan dalam kehidupan manusia sama ada dalam aspek fizikal, mental, emosi dan juga rohani (Mohd Jailani et al. 2020).

Dalam kajian perubatan dan kajian muziknya, al-Kindi menggunakan hubungan antara pernafasan dan bunyi yang memberi manfaat dan berkesan kepada jiwa dan badan manusia. Hasil penelitian yang dilakukan dicatatkan di dalam beberapa karya beliau antaranya karya *Kitabul-ul Musavvitad* di mana al-Kindi menyentuh tentang jenis bunyi yang membangkitkan atau menghilangkan pelbagai jenis perasaan. Sementara dalam karyanya berjudul *Risale fi Hubr Sinaati-Te'lif*, al-Kindi menulis tentang bunyi yang baik untuk telinga manusia dan mencadangkan melodi yang harmoni dan mempunyai kesan positif kepada manusia (Cifdaloz 2019; Cifdaloz & Heiderscheit 2016). Bukan sekadar penerokaan teori muzik, Al-Kindi pernah pernah mengaplikasikan rawatan terapi muzik dengan mencuba untuk merawat seorang kanak-kanak lumpuh menggunakan alunan muzik (Mohd Jailani 2019).

Al-Razi

Al-Razi atau nama utamanya ialah Abu Bakr Muhammad Ibn Zakariyya al-Razi (854-932M) merupakan seorang ahli falsafah Parsi, ahli kimia dan juga pakar perubatan. Beliau dikenali sebagai *Galen Arab* kerana sumbangannya yang hebat dalam bidang sains perubatan. Beliau telah dilahirkan pada tahun 865M di Al Rayy, sebuah bandar di lereng selatan pergunungan El

Burz berhampiran Tehran, sekarang di Iran. Al-Razi sewaktu umur remaja merupakan seorang yang suka menyanyi, memainkan oud serta berminat dalam puisi, sastera dan muzik. Namun setelah umurnya meningkat dewasa sekitar 20 tahun, beliau telah menahan dirinya daripada bermain alat muzik dan mengfokuskan kepada bidang kimia, perubatan dan falsafah. Beliau menamatkan pendidikannya di Baghdad dan di kota-kota Islam yang lain dan kemudiannya bekerja sebagai ketua doktor di hospital Ray dan Baghdad (Tbakhi & Samir, 2007; Cifdaloz & Heiderscheit, 2016).

Al-Razi merupakan salah seorang sarjana yang mempunyai kepercayaan bahawa muzik hanya boleh digunakan untuk pesakit mental atau tekanan psikologi sahaja. Fakta ini dicatatkan dalam karyanya berjudul *Kitab al-Mansuri Fi al-Tibb* di mana al-Razi mendengarkan lagu kepada Amir Mansur b. Nuh b. Nasr, yang menderita penyakit kronik dan kesedihan (Isgandarova 2015). Langkah tersebut diambil kerana menurut beliau pesakit mental boleh disembuhkan dengan mendengar lagu yang dinyanyikan oleh penyanyi bersuara indah. Di samping mendengar lagu, al-Razi turut mencadangkan beberapa kaedah yang lain bagi pesakit mental iaitu meluangkan masa melakukan aktiviti yang menyeronokkan seperti memancing, bersama orang yang mereka suka serta belajar dan mengajar muzik. Dia percaya bahawa hanya dengan cara itu pesakit boleh mempunyai peluang untuk mengatasi kebosanan dan kegelisahan mereka sehingga pulih (Egilmez 2009; Cakmak & Avci 2020; Erdal & Erbas 2013).

Menurut Tbakhi & Samir (2007), al-Razi merupakan perintis dalam rawatan penyakit mental (psikiatri). Semasa beliau berkhidmat sebagai ketua pengarah hospital di Baghdad, beliau telah menubuhkan satu bahagian khas untuk rawatan pesakit mental di hospital berkenaan. Beliau juga turut melayan pesakitnya dengan rasa hormat, prihatin dan empati. Di samping itu, beliau turut menyediakan sejumlah wang untuk setiap pesakit bagi membantu untuk keperluan sementara setelah sembuh dan keluar daripada hospital.

Al-Farabi

Al-Farabi (874M-950M) atau nama sebenarnya nama utamanya ialah Abu Nasr Muhammad ibn Muhammad ibn Tarkhan ibn Awzalagh, merupakan seorang doktor dan ahli falsafah muzik berketurunan Turki. Beliau telah dilahirkan pada tahun 890M di Wasij, sebuah perkampungan kecil daerah Farab dalam wilayah Transoxiana, Turkestan. Beliau meninggal dunia di Damsyik pada tahun 950M-951M ketika umurnya 80 tahun. Al-Farabi dianggap sebagai ulama kedua besar Islam selepas al-Kindi dalam sumbangannya terhadap bidang muzik. Beliau juga dikenali sebagai *ustad-ı Sani*, *Hâce-i Sani*, *Muallim-i Sani* (guru pertama ialah Aristotle) di dunia Islam "*Alpharabius*" dalam sumber Barat. Beliau mula mempelajari ilmu muzik ketika sedang menuntut ilmu di wilayah Bukhara dan pernah menjadi guru muzik kepada Ibn Sarraj (wafat 929M) iaitu seorang sarjana dan penyair hebat di Baghdad (Osman 1998; Zaimeche 2008).

Al-Farabi banyak menghasilkan karya dalam bidang muzik. Beliau menghasilkan kira-kira seratus enam puluh karya: lapan daripada buku ini meneroka muzik, kuasa huruf dan bunyi. Walau bagaimanapun, hanya empat daripada kitab ini yang terselamat: *Kitap-ul Musiki-ul Kebir* atau *Kitab al-Musiqā al-Kabir*, *Kitab fi Ihsan al-Iqa*, *Kitab fi'l Nuqra*, *Kitab fi'l Musiqā* (Cakmak & Avci 2020; Isgandarova 2015). *Kitab al-Musiqā al-Kabir* (*Great Book of Music*) yang ditulis oleh al-Farabi merupakan karya teori muzik paling berpengaruh pada abad pertengahan. Karya ini ditulis oleh al-Farabi pada era pemerintahan Karahanid (840M-1212M) (Mihaljinec 2021) di atas permintaan Abu Ja'far Muhammad b. al-Qasem al-Kharki, wazir khalifah al-Razi pada tahun 936M (Osman Bakar 1998; Isgandarova 2015). Menurut Mohd Jailani (2019), karya ini mengandungi perbincangan yang paling lengkap berkenaan seni muzik Arab dan masih terpelihara sehingga ke hari ini. Karya ini telah menjadi rujukan asas bagi teori muzik Turki (Mihaljinec 2021) serta turut dijadikan rujukan oleh sarjana-sarjana Islam dan

Yahudi pada zaman selepasnya dari abad ke-11M sehingga abad ke-20M termasuklah Ibn Sina dan Tantai.

Terdapat beberapa perbincangan mengenai muzik dalam hubungan dengan kesihatan manusia dalam karya *Kitab al-Musiqah al-Kabir* oleh al-Farabi. Menurut Hashemimehr & Farkhondehzadeh (2022), dalam karya ini al-Farabi menghuraikan tentang muzik, hubungannya dengan jiwa dan juga kesannya terhadap emosi. Selain itu, al-Farabi juga menganggap muzik sebagai suatu keperluan semula jadi bagi semua makhluk hidup sama ada manusia mahupun haiwan. Sebagai contoh, individu yang kepenatan dengan kerja harian sudah tentu memerlukan unsur hiburan yang boleh diberikan oleh muzik untuk memberi kelegaan dan merangsang semangat mereka untuk meneruskan kerja dengan lebih tekun. Begitu juga, haiwan seperti unta memerlukan alunan lagu *al-huda* untuk mempercepatkan perjalanan jauh mereka, tanpa mepedulikan beban di punggung mereka. Pesakit sangat memerlukan muzik sebagai medium terapeutik untuk memberikan sedikit kelegaan daripada kesakitan melalui alunan pelbagai jenis melodi muzik yang berbeza (Mohd Jailani et al. 2020).

Dalam konteks muzik bagi sebagai elemen terapeutik kepada pesakit, al-Farabi turut mencadangkan jenis-jenis makam yang berkesan dan bersesuaian ke atas kesihatan manusia. Untuk menentukan makam yang sesuai dalam masa-masa tertentu sepanjang hari, al-Farabi meneroka kesan azan dan menetapkan makam berikut selepas solat setiap hari kerana kesan positifnya terhadap emosi manusia (Isgandarova 2015). Jadual 1 merupakan jenis makam beserta kesan ke atas manusia dan waktu-waktu yang sesuai digunakan mengikut pandangan al-Farabi:

Jadual 1 kesan makam ke atas manusia serta waktu yang bersesuaian

Jenis Makam	Kesan ke atas manusia	Waktu yang bersesuaian
Rehavi	Memberikan perasaan keabadian dan melapangkan jiwa manusia	Selepas solat subuh
Hüseyni	Memberikan perasaan kedamaian, ketenangan dan kesenangan	selepas solat subuh atau pada waktu pagi
Rast	memberikan kebahagiaan dan ketenangan serta merangsang perasaan gembira dan damai	Selepas matahari terbit atau apabila matahari naik dua tombak panjang.
Zengule	Memberikan rasa mengantuk serta menimbulkan keinginan untuk tidur	Sebelum tengahari
Ussak	membuatkan seseorang ketawa	Pada tengahari
Buselik	memberi kekuatan pada seseorang	Pada pertengahan tengahari atau lewat pagi
Hejaz	melahirkan perasaan rendah diri	pada sebelah petang
Isfahan	Memberi keupayaan mobiliti dan rasa selamat	Pada waktu senja
Neva	memberikan perasaan nyaman dan seronok	selepas solat isya
Buzurg/ Büzürk	menjadikan seseorang merasa takut	selepas solat larut malam

Sumber: Isgandarova (2015); Erdal & Erbas (2013); Benek et al. (2015); Mohd Jailani & Roziah (2016)

Ibn Sina

Ibn Sina (980M-1037M) atau nama sebenar beliau iaitu Abu Ali al-Husayn ibn Abd Allah ibn Ali ibn Sina merupakan seorang doktor dan ahli falsafah Islam terkenal yang dikenali dengan nama Avicenna. Beliau adalah berasal dari Bukhara. Menurut Ibn Sina, bunyi yang diwarisi dalam fitrah kemanusiaan membawa beberapa fungsi dalam menghasilkan emosi yang berbeza serta menyampaikan mesej keperluan contohnya seperti keperluan untuk perlindungan, seks, dan kegembiraan (Isgandarova 2015; Siti Norhidayah & Roziah 2017). Selain itu, bunyi yang disusun dan digubah membentuk melodi yang harmoni akan memberi kesan yang mendalam kepada kesihatan manusia bahkan mampu menghidupkan jiwa manusia (Cifdaloz & Heiderscheit 2016). Ibn Sina juga beranggapan bahawa gubahan muzik yang menarik bukan sekadar mampu menenangkan telinga pendengar, bahkan juga mampu mempengaruhi dan boleh mengubah keadaan seseorang ke arah yang lebih baik dan positif seperti menghilangkan perasaan sedih, menenangkan seseorang dan meredakan kesakitan (Mohd Jailani et al. 2020).

Pandangan Ibn Sina tentang muzik dijelaskan dalam karya ensiklopedianya seperti: *Cevami'u Ilmi'l-Musika (Javamiu Ilmi al-Musiqqa)* dalam *Kitabu's-Sifa (Kitab al-Shifa)*; *Muhtasar i Ilm al-Misuiqa* dalam *Kitan al-Nejat*; bab muzik dalam *Danish-name-i 'Alai*. Selain itu, beliau juga menulis tentang muzik dalam bukunya seperti *Risalah fi al-Huruf*, *Risalah fi al-Nafs*, *Risalah fi Bayani Aksam al-Kikmetiyyah wa al-Aqliyya* dan *al-Qanun fi al-Tibb* (Isgandarova 2015). Menurut Mihaljinec (2021), Ibn Sina membahaskan mengenai konsep muzik dalam *Cevami'u Ilmi'l-Musika (Javamiu Ilmi al-Musiqqa)* dengan menyentuh beberapa perkara utama iaitu definis muzik, note muzik, selang, jenis-jenis ritma, composing dan juga instrumen-istrumen muzik. Karya ini juga mengetengahkan mengenai pandangan beliau terhadap muzik meliputi teori muzik dan juga terapi muzik. Dalam konteks terapi muzik, Ibn Sina mengemukakan hubungan di antara muzik dan perubatan melalui kenyataannya:

“..... The best treatment with the most efficient effect is to raise mental strength so that the patient is encouraged to handle the illness easier, to ensure pleasant and satisfactory environment, play the best music and provide meeting with their beloved ones...”

(Mihaljinec 2021: 96)

Buku *al-Qanun fi al-Tibb (The Canon of Medicine)* merupakan antara karya perubatan Ibn Sina yang paling menonjol dan digunakan secara meluas di pada zaman abad pertengahan dan Renaissance Eropah bermula dari abad ke-12M sehingga abad ke-17M (Ghazal 2004). Karya ini pernah diterjemahkan ke dalam bahasa Turki oleh Tokatli Mustafa Efendi dan juga ke bahasa Latin oleh Gerard of Cremona (Afacan 2010). Menurut Heybeli (2008) dan Ucaner & Heiderscheit (2016), karya ini juga merupakan karya asas dalam perkembangan perubatan Uthmaniyyah. Ianya diajarkan di Kulliye dan juga dijugakan di Eropah sehingga pertengahan abad ke-17M. merupakan asas bagi pembangunan amalan perubatan muzik (*musical-medical practice*) dalam tamadun Islam abad pertengahan (Moon 2021).

Dalam karya *al-Qanun fi al-Tibb*, Ibn Sina menekankan aspek perkaitan di antara emosi dengan keadaan fizikal dan mengemukakan bahawa muzik mampu mempengaruhi fizikal dan psikologi seseorang manusia (Gorini 2007). Selain itu, Ibn Sina turut mencatatkan beberapa jenis gangguan mental yang boleh dirawat melalui terapi muzik iaitu merangkumi *al-yaqazah wa al-sahar* (insomnia), *al-malinkhuliya* (melankolia) dan *al-ishq* (mabuk cinta). Para pesakit ini disyorkan oleh Ibn Sina untuk mendengar muzik dan nyanyian yang lembut dan merdu dengan irama seperti *al-hazaj* dan *al-thaqil* selain dari rawatan-rawatan lain seperti terapi mandian, urut dengan tuam, ubat-ubatan, diet berkhasiat, rekreasi, kaunseling dan lain-lain lagi (Mohd Jailani et al. 2019; Roziyah et al. 2022).

Pada jilid ketiga dalam *al-Qanun fi al-Tibb*, Ibnu Sina berkata:

“Cara rawatan yang terbaik dan paling berkesan adalah untuk meningkatkan kekuatan mental dan rohani pesakit, untuk menggalakkan dia dalam memerangi penyakit dengan lebih baik, untuk menjadikan persekitarannya indah, untuk membuat dia mendengar kepada muzik yang terbaik, dan untuk membawanya bersama-sama dengan orang yang dia sayangi”

(Ahmed & Hasan 2016; Cifdaloz 2019; Mihaljinec 2021).

Beliau berpendapat bahawa muzik mampu meningkatkan kekuatan mental dan spiritual pesakit bahkan juga mampu memberi sokongan moral yang kuat kepada pesakit semasa rawatan (Benek et al. 2015). Ibn Sina juga dikatakan pertama kali mendiagnosis dan menggambarkan penyakit cinta pada seorang Putera Jurjan yang terbaring sakit. Ibn Sina memeriksa denyutan nadi putera dan menyebut secara kuat banyak nama meliputi nama wilayah, daerah, bandar, jalan dan juga nama orang. Apabila nama dan alamat seorang perempuan disebut, denyutan nadinya bertambah dan kemudian Ibn Sina menyarankan agar menyatukan putera tersebut dengan kekasihnya untuk menghilangkan penderitaannya (Ahmed & Hasan 2016; Syed 2002). Ibn Sina juga pernah terlibat dalam penyembuhan gangguan mental dengan muzik di sebuah hospital yang ditubuhkan di Damsyik. Pengaruh Ibnu Sina berterusan sehingga zaman Uthmaniyyah (Somakçı t.th).

Jadual 2 merupakan jenis makam (mod muzik) dan masa yang sesuai yang disarankan oleh Ibn Sina.

Jadual 2 Jenis makam dengan masa yang bersesuaian menurut pandangan Ibn Sina

Jenis makam	Masa yang bersesuaian
Rahawi	Waktu Fajar Kadhif
Husayni	Waktu Fajar Sadiq
Rast	Waktu Matahari terbit
Busalik	Waktu Pagi
Zankulah/zarkulah dan cUshshaq	Waktu Tengahari
Hijaz	Waktu antara solat Zohor dan Asar Waktu Petang
Iraq	Waktu Petang
Isfahan	Waktu Matahari terbenam
Nawa	Waktu Malam
Buzurk	Selepas waktu Maghrib
Mukhalif (Zirafkand)	Sebelum waktu tidur

Sumber: Mohd Jailani & Roziyah (2016)

KESIMPULAN

Muzik merupakan suatu elemen hiburan yang sentiasa dinikmati bahkan telahpun sebatik dalam kehidupan seharian kita. Dalam Islam, penggunaan elemen seni muzik bukan hanya berfokuskan untuk mencari keseronokan dan hiburan semata-mata, bahkan juga boleh dimanfaatkan sebagai terapi. Hiburan muzik yang mengandungi unsur-unsur positif sudah pasti mampu melahirkan insan yang sihat bukan sahaja secara jasmani malahan juga secara rohani dan mental seperti terhindar dari permasalahan emosi, kecelaruan minda dan jiwa, bebas dari tekanan masalah rumahtangga, tempat kerja dan sebagainya. Sejarah tamadun Islam abad pertengahan juga membuktikan bahawa terapi muzik telah telah dibangunkan dan dikembangkan oleh para ilmuwan dalam Islam bermula abad ke-9M menerusi proses asimilasi dan islamisasi ilmu terapi muzik dari tamadun Greek bagi tujuan merawat masalah kesihatan mental. Konsep falsafah terapi muzik yang dibangunkan oleh tamadun Islam ini boleh

dijadikan iktibar serta kaedah rawatan alternatif atau komplementari bagi membendung masalah kesihatan mental yang semakin hari semakin menular di negara kita pada hari ini.

PENGHARGAAN

Kajian ini ditaja oleh geran Kursi Syeikh Abdullah Fahim (RH-2020-008) di Institut Islam Hadhari, Universiti Kebangsaan Malaysia.

RUJUKAN

- Afacan, S. 2010. From Traditionalism To Modernism: Mental Health In The Ottoman Empire. Tesis Sarjana, Sabanci University
- Ahmed, S & Hasan, M. M. 2016. Muslim heritage in medicine: a concise review on Greco-Arabic contribution. *Journal of Pharmacognosy and Phytochemistry* 5(4): 273-283.
- Al-Ghazal, S. K. 2004. The influence of Islamic Philosophy and ethics on the development of medicine during the Islamic Renaissance. *Journal of International Society for the History of Islamic Medicine (JISHIM)* 3: 1-9.
- Atiyah Ali. & Siti Maryam. (2018). Ulasan mini: gelombang muzik dan alunan ritma sebagai terapi kemurungan. *Asian People Journal (APJ)*, 1(2), 217-221.
- Awaad, R. Elsayed, D. & Helal, H. (2021). Holistic healing: Islam's legacy of mental health. United States: Yaqeen Institute for Islamic Research.
- Benek, B. S., Sakar, H., Bayram, R., & Gumustekin, K. (2015). The oldest medical center of the anatolia: Gevher Nesibe Darussifa and Medical School. *Acta Medica Anatolia*, 3(3), 108-110.
- Cakmak, Y. & Avci, N. (2020). Music Therapy in the World and Turkey. *International Journal of Basic and Clinical Studies (IJBCS)* 9,(2), 27-36.
- Çifdalöz, B. U. (2019). Music therapy and music based interventions for dementia and end of life care in Turkey. *Journal of International Social Research*, 12(67), 530-535.
- Çifdalöz, B.U. (2020). Music therapy in Turkey: historical background and current perspectives on dementia and end-of-life care. *Approaches: An Interdisciplinary Journal of Music Therapy Special Feature*, 12(67), 1–9.
- Dewi, M. P. (2009). Studi metaanalisis: musik untuk menurunkan stres. *Jurnal Psikologi*, 36(2), 106-115.
- Dobrzynska, E., Cesarz, H., Rymaszewska, J. & Kieyna, A. (2006). Music therapy: history, definitions and application. *Archives of Psychiatry and Psychotherapy*, 8(1), 47-52.
- Egilmez, H. O., Egilmez, O. & Atalay, M. A. (2009) Music therapy and maqams' healing effects in the Turkish nation. *Proceedings of the 6th International Conference of the Greek Society for Music Education, "Music: Trains, Educates, Heals"*, Athens, 30/10 - 01/11/2009.
- Erdal, G., & Erbaş, İ. (2013). Darüşşifas where music therapy was practiced during anatolian seljuks and ottomans. *Journal of History Culture and Art Research*, 2(1), 1-19.
- Golden, T., Springs, S., Kimmel, H. J., Gupta, S., Tiedemann, A., Sandu, C. C. & Magsamen, S. (2021). The use of music in the treatment and management of serious mental illness: a global scoping review of the literature. *Frontiers of Psychology*, 12, 1-19.
- Gorini, R. (2007). Bimaristans and mental health in two different areas of the medieval Islamic world. *Journal of International Society for the History of Islamic Medicine (JISHIM)*, 6-7.

- Goyal, A. K., Yadav, G., & Yadav, S. (2012). Music therapy: a useful therapeutic tool for health, physical and mental growth. *International Journal of Music Therapy*, 2, (1-2), 13-18.
- Hashemimehr, M. & khondehzadeh, M. 2022. Music Therapy and Its Status in Iranian Medical Texts and Knowledge: The association Between Music and Medicine
- Heybeli, N. 2008. Sultan Bayezid II Kulliyesi: one of the earliest medical schools-founded in 1488. *Clinical Orthopaedics and Related Research* 467: 2457–2463.
- Hsu, W. C., & Lai, H. L. (2004). Effects of music on major depression in psychiatric inpatients. *Archives of Psychiatric Nursing*, 18(5), 193-199.
- Isgandarova, N. (2015). Music in Islamic spiritual care: a review of classical sources. *Religious studies and theology*, 34(1), 101.
- Izaida Ibrahim. (2018). Complementary and alternative medicine (CAM) as treatments for psychiatric Disorders: a guide for mental health professionals. *Jurnal Psikologi Malaysia*, 32(2), 1-11.
- Mihaljinec, I. (2021). Music as healing in the Anatolian Seljuk Times. (Tesis Sarjana, University of Zadar, Croatia).
- Mohd Jailani Abdullah & Roziah Sidik @ Mat Sidek. (2016). Sejarah terapi muzik dalam tamadun Islam dan realiti masa kini. *Prosiding Seminar Kebangsaan Tamadun & Warisan Islam (TAWIS)*, 229-248.
- Mohd Jailani Abdullah, Roziah Sidik @ Mat Sidek & Azmul Fahimi Kamaruzaman. (2020). Impact of music therapy on mental patients: Review based on implementation of music therapy in the Islamic civilization. *International Journal of Business and Social Science*, 11(10), 102-108.
- Mohd Jailani Abdullah, Roziah Sidik @ Mat Sidek, Azmul Fahimi Kamaruzaman. (2019). Terapi Muzik Sebagai Rawatan Komplementari Di Bimarastan Al-Mansuri Pada Abad Ke 13 Masihi (Music Therapy as a Complementary Treatment in Bimarastan al-Mansuri during the 13th Century). *Journal of al-Tamaddun*, 14(1), 27-36.
- Mohd Jailani Abdullah, Roziah Sidik @ Mat Sidek, Azmul Fahimi Kamaruzaman & Firuz Akhtar Mohamad Bohari. (2020). Analisis sumber pemahaman falsafah terapi muzik pada abad pertengahan Islam. *Journal of al-Tamaddun*, 15(1), 1-11.
- Mohd Jailani Abdullah. (2019). Epistemologi terapi muzik dan aplikasinya di Bimarastan Al-Mansuri pada abad ke-13 masihi. (Tesis Doktor Falsafah, Universiti Kebangsaan Malaysia, Malaysia).
- Moon, S. R. 2021. Sound, science, Islam: music as healing in Istanbul. Tesis Doktor Falsafah, Faculty of the Dietrich School of Arts and Sciences, Universiti of Pittsburgh
- Muhammad Asyraf Mohd Bakri & Kamal Sabran. 2021. Gambus melayu and its therapeutic purposes. *KUPAS SENI Jurnal Seni dan Pendidikan Seni*, 9(2), 77-98.
- Noor Atiqah Sulaiman. (2022, Oktober 10). Masalah kesihatan mental membimbangkan – Khairy. *Berita Harian*. Diakses pada Oktober, 15, 2022, dari <https://www.bharian.com.my>.
- Osman, O. (1998). *Classification Of Knowledge In Islam A Study In Islamic Philosophies Of Science*. England: Cambridge University Press.
- Pacholczyk, J. (1996). Music and astronomy in the Muslim world. *Leonardo*, 29(2), 145-150.
- Raglio, A., Attardo, L., Gontero, G., Rollino, S., Groppo, E., & Granieri, E. (2015). Effects of music and music therapy on mood in neurological patients. *World journal of psychiatry*, 5(1), 68.
- Rahshenas, N., Motamedi, M. H. K., Nazari, M. S., Nasiri, K., & Shahidi, S. (2015). Effect of music therapy on stress: Is it really effective? *International Journal of Emergency Mental Health*, 17(2), 446.

- Roziyah Sidik @ Mat Sidek, Azmul Fahimi Kamaruzaman & Mohd Jailani Abdullah. 2022. Music therapy in medicine of Islamic civilization. Dalam Amit Agrawal, Roshah Sutar dan Anvesh Jallapally. *Music in Health and Diseases*. London: IntechOpen.
- Sabry, W. M., & Vohra, A. (2013). Role of Islam in the management of psychiatric disorders. *Indian journal of psychiatry*, 55, 205-214.
- Saoud, R. (2004). The Arab contribution to music of the western world. *Foundation for science technology and Civilisation*, 1-26.
- Sarhan, W. (2017). The contribution of Arab Islamic civilization to mental health. *The Editorial Assistants–Jordan*, 28(1), 57-66.
- Shiloah, A. 1995. *Music in the World of Islam. A Socio-Cultural Study*. Great Britain: Scolar Press.
- Shiloah, A. 1993. Musical modes and the medical dimension: The Arabic source (c.900-c.1600). Dlm. Shiloah, A. (pnyt). *The Dimension of music in Islamic and Jewish culture*, hlm. 147-159. Great Britain: Variorum.
- Siti Norhidayah Mohd Sufie & Roziyah Sidik @ Mat Sidek. (2017). What is medical music therapy in Islamic civilization?. *International Journal of Business and Social Science*, 8(3), 195–199.
- Stuckey, H. L., & Nobel, J. (2010). The connection between art, healing, and public health: A review of current literature. *American journal of public health*, 100(2), 254-263.
- Syed, I. 2002. Islamic medicine: 1000 years ahead of its time. *Journal of International Society for the History of Islamic Medicine (JISHIM)* 2: 2-9.
- Tang, Q., Huang, Z., Zhou, H., & Ye, P. (2020). Effects of music therapy on depression: A meta-analysis of randomized controlled trials. *PloS one*, 15(11).
- Tbakhi, A. & Samir, S. A. (2007). Arab and Muslim physicians and scholars; Ibn Al-Haytham: father of modern optics. *Jurnal Ann Saudi Med*, 27(6).
- Torres, M., Ramos, J., Suárez, M., García, A., & Mendoza, T., 2016. Benefits of using music therapy in mental disorders. *Journal of Biomusical Engineering*, 4(1), 1-4.
- Ucaner, B., & Heiderscheit, A. (2016). Music therapy in Turkey: curriculum development and professional collaboration. *Music Therapy Today*, 12(1), 8-20.
- Wang, S. & Agius, M. 2018. The use of music therapy in the treatment of mental illness and the enhancement of societal wellbeing. *Psychiatria Danubina*, 30(7), 595-600.
- Zaimeche, S. 2008. Aleppo. Muslim Heritage. <https://muslimheritage.com/people/authors/salah-zaimeche/>. Diakses 10 september 2022.
- Zincir, S. B., Zincir, S., Yenel, A., Kivilcim, Y., Cetin, B., Tulay, C., & Basar, U. (2014). Classical turkish music as group music therapy for inpatients with schizophrenia: Feasibility and efficacy. *International Journal*, 2(4), 1063-1072.

Keperluan Keterangkuman Digital dalam Pemerkasaan Usahawan B40 di Selangor

Faradillah Iqmar Omar
Kolej Universiti Islam Antarabangsa Selangor
faradillah@kuis.edu.my

Nur Hafidhzah Nor Hasim
Kolej Universiti Islam Antarabangsa Selangor
hafidhzahhasim01@gmail.com

ABSTRACT

Technology should be considered as an important tool for business owners or managers, which cannot be ignored because it allows small businesses to access markets, connect with global supply chains, locate customers cost-effectively and improve their internal operations. The productivity and effectiveness of small and medium-sized enterprises in developing countries is also affected by the rate of diffusion of communication technology, which is considered an important driver for business expansion in rural environments. This also gives a boost to the B40 group of entrepreneurs from an economic and business continuity point of view. This paper aims to find out the need for digital inclusion (social networks, marketing, training) in the empowerment of B40 entrepreneurs in Selangor. Among the objectives of the study is to find out the level of frequency of digital inclusion among B40 entrepreneurs as well as test the implications of the need for digital inclusion on the empowerment of B40 entrepreneurs. Quantitative method was used in this study by distributing questionnaires face-to-face to 618 B40 entrepreneurs with multi-level sampling. The data was analyzed descriptively to obtain an interpretation of the mean score and analyzed inferentially through regression tests to find out the contribution of the independent variable to the dependent variable. The results of the study found that the level of frequency of social networking and marketing is moderately high, while training is moderately low. The results of the multiple regression test (Stepwise) found that social networks and marketing make a positive contribution to the empowerment of B40 entrepreneurs. This finding explains that entrepreneurs who have a good level of social networks and marketing have a high level of empowerment.

Keywords: Digital inclusion; empowerment; entrepreneurs; B40

ABSTRAK

Teknologi harus dianggap sebagai alat penting untuk pemilik atau pengurus perniagaan, yang tidak dapat diabaikan kerana memungkinkan perniagaan kecil untuk mengakses pasaran, berhubung dengan rantai bekalan global, mengesan pelanggan dengan kos efektif dan meningkatkan operasi dalaman mereka. Produktiviti dan keberkesanan perusahaan kecil dan sederhana di negara-negara membangun juga dipengaruhi oleh kadar penyebaran teknologi komunikasi, yang dianggap sebagai pemacu penting untuk pengembangan perniagaan di persekitaran luar bandar. Perkara ini turut memberi tempias kepada kelompok usahawan B40 dari sudut ekonomi dan kesinambungan perniagaan. Kertas kerja ini bertujuan untuk mengetahui keperluan keterangkuman digital (jaringan sosial, pemasaran, latihan) dalam pemerkasaan usahawan B40 di Selangor. Antara objektif kajian adalah untuk mengetahui tahap kekerapan keterangkuman digital dalam kalangan usahawan B40 serta menguji implikasi keperluan keterangkuman digital terhadap pemerkasaan usahawan B40. Kaedah kuantitatif digunakan dalam kajian ini dengan edaran borang soal selidik secara bersemuka kepada 618 usahawan B40 dengan pensampelan pelbagai peringkat. Data dianalisis secara deskriptif bagi memperoleh interpretasi skor min dan analisis secara inferens melalui ujian

regresi bagi mengetahui sumbangan pemboleh ubah bebas terhadap pemboleh ubah terikat. Hasil kajian mendapati bahawa tahap kekerapan jaringan sosial dan pemasaran adalah sederhana tinggi, manakala latihan adalah sederhana rendah. Hasil ujian regresi pelbagai (Stepwise) pula mendapati jaringan sosial dan pemasaran memberi sumbangan yang positif terhadap pemeraksanaan usahawan B40. Dapatan ini menjelaskan bahawa usahawan yang mempunyai jaringan sosial dan pemasaran dengan tahap yang baik mempunyai tahap pemeraksanaan yang tinggi.

Kata kunci: *Keterangkuman digital; pemeraksanaan; usahawan; B40*

PENGENALAN

Keterangkuman digital merujuk kepada aktiviti yang diperlukan untuk memastikan semua individu dan masyarakat, termasuk mereka yang kurang bernasib baik, mempunyai akses dan menggunakan Teknologi Maklumat dan Komunikasi (ICT). Ini termasuk 5 elemen iaitu; 1) perkhidmatan internet jalur lebar yang berpatutan dan kukuh; 2) peranti yang membolehkan internet yang memenuhi keperluan pengguna; 3) akses kepada latihan literasi digital; 4) sokongan teknikal yang berkualiti; dan 5) aplikasi dan kandungan dalam talian yang direka untuk membolehkan dan menggalakkan pencapaian, penyertaan dan kerjasama. Ringkasnya, keterangkuman digital adalah kerangka untuk menilai dan mempertimbangkan kesediaan masyarakat untuk mengakses kepada peluang dalam era digital ini. Terdahulu, Crandall dan Fisher (2009) mencadangkan keterangkuman digital adalah melebihi akses kepada komputer dan internet untuk semua, tanpa mengira kemampuan fizikal, kognitif, atau kewangan; ia bermakna celik teknologi dan keupayaan untuk mengakses kandungan dan perkhidmatan dalam talian yang berkaitan. Hache dan Cullen (2012) memperluaskan definisi dengan mengatakan bahawa keterangkuman digital adalah proses pendemokrasian akses kepada ICT untuk membolehkan penglibatan masyarakat yang terpinggir. Mereka mendakwa bahawa keterangkuman digital sepatutnya dilihat sebagai pemangkin kepada keterlibatan sosial yang memastikan individu dan kumpulan yang kurang bernasib baik mempunyai kemahiran untuk menggunakan ICT, seterusnya menunjukkan individu-individu ini akan mendapat manfaat daripada pengetahuan elektronik yang berkembang dalam masyarakat maklumat.

Artikel ini memfokuskan tentang keperluan keterangkuman digital dengan 3 dimensi yang telah dikenal pasti iaitu jaringan sosial, pemasaran dan latihan. Bagi mendalami keperluan keterangkuman digital dari aspek perniagaan, justeru artikel ini menguji hubungan dan sumbangan ketiga-tiga dimensi tersebut terhadap pemeraksanaan usahawan B40 di negeri Selangor. Selain itu, kelompok usahawan B40 ini perlu diberi perhatian sewajarnya dalam pelbagai aspek yang boleh membantu memperkukuh serta memperkasakan mereka dalam konteks masyarakat dan ummah yang berdaya saing dalam perniagaan yang merupakan salah satu aktiviti sunnah dan digalakkan dalam agama.

Keterangkuman Digital

Menurut Kamus Dewan Edisi Keempat, definisi terangkum adalah termasuk dalam lingkungan sesuatu seperti menangkap sesuatu yang didengar. Istilah keterangkuman juga boleh diertikan sebagai sebuah penghormatan atau penerimaan terhadap keperluan individu yang pelbagai dalam sesebuah kelompok. Manakala, digital pula merujuk kepada sesuatu unsur dalam sistem komputer yang beroperasi dengan menggunakan aksara atau angka untuk mewakili data ataupun menukarkan data kepada bentuk digital supaya dapat diproses secara langsung oleh komputer (Kamus Dewan Edisi Keempat). Oleh itu, keterangkuman digital bermaksud sesebuah aktiviti yang diperlukan untuk memastikan setiap golongan sama ada individu

ataupun komuniti, termasuk mereka yang terpinggir ataupun kurang bernasib baik untuk mempunyai akses dan mampu menggunakan Teknologi Maklumat dan Komunikasi (TMK) (Faradillah et. al, 2021). Dengan memahami konsep keterangkuman digital, ia dapat membantu memberikan pemahaman yang lebih baik dan penyertaan digital yang lebih ideal.

Dewasa kini, ekonomi negara kian berkembang pesat melalui sumbangan yang diberikan khususnya melalui bidang perniagaan oleh pelbagai lapisan masyarakat dan latar belakang khususnya adalah usahawan B40. Perniagaan yang dijalankan oleh usahawan B40 kebanyakannya adalah perusahaan kecil dan sederhana (PKS) dan secara tidak langsung, ia dapat menyumbang kepada pertumbuhan keluaran dalam negara kasar (KDNK). Berita Harian Online (2022) melaporkan bahawa berlaku peningkatan dalam KDNK dari RM547.3 billion pada tahun 2020 kepada RM 572.6 billion pada tahun 2022 melalui sektor PKS. Revolusi internet telah memberikan impak yang besar terhadap ekonomi negara. Hal ini disebabkan oleh kemunculan fungsi internet di dalam TMK serta kewujudan pelbagai aplikasi baru untuk menjalankan dan menguruskan perniagaan usahawan B40. Tambahan pula, pengenalan TMK telah mendukung pengusaha untuk ke tahap yang lebih tinggi dalam bidang perniagaan (Faradillah et. al, 2021). Walaupun pada asalnya usahawan B40 hanya menjalankan perniagaan secara kecil-kecilan, namun ia tidak melunturkan semangat mereka untuk menjalankan perniagaan ke persada dunia. Ia dapat dibuktikan dengan bantuan yang diberikan oleh SME Bank yang telah menyediakan platform dengan memberi peluang kepada PKS tempatan untuk menembusi pasaran antarabangsa sama ada perusahaan secara persendirian ataupun perkongsian (Berita Harian Online, 2022).

Terdahulu, pengusaha menjalankan perniagaan secara tradisional dan sukar untuk pengguna untuk memperolehi sesuatu produk atau mendapatkan perkhidmatan kerana mereka perlu mencari beberapa kedai fizikal demi mendapatkan produk ataupun perkhidmatan yang dikehendaki. Dengan kewujudan TMK dalam bidang perniagaan pada masa kini, ia dapat menarik lebih ramai pengguna dalam mendapatkan produk ataupun perkhidmatan. Hal ini disebabkan oleh teknologi semakin berkembang seiring perkembangan semasa, peningkatan bilangan individu berpendidikan, perubahan taraf hidup serta peningkatan pendapatan (Muhammad Wafi & Sharifah Rohayah, 2021). Bukan itu sahaja, kehadiran pandemik Covid-19 juga merupakan salah satu punca masyarakat menggunakan kemudahan TMK. Menurut Ketua Perangkawan Malaysia, Dato' Sri Dr Mohd Uzir, terdapat peningkatan peratusan terhadap capaian isi rumah kepada internet iaitu dari 91.7 peratus pada 2020 kepada 95.5 peratus pada 2021 (Jabatan Perangkaan Malaysia, 2022). Selain itu, hasil daripada kajian selidik oleh SME Corporation mendapati wujud peningkatan keterlibatan PKS dalam perniagaan secara dalam talian pada tahun 2018 iaitu dari 26 peratus kepada 37 peratus (Berita Harian Online, 2020). Jelas ia dapat dilihat bahawa pengusaha dan pengguna lebih memilih untuk menggunakan kaedah pembelian dalam talian berbanding pembelian secara bersemuka kerana dapat menjimatkan masa di samping dapat melakukan pelbagai transaksi perniagaan dalam talian (Zaleha et al., 2016).

Walau bagaimanapun, pengusaha perlu sentiasa mempromosikan jualan mereka dengan mempelbagaikan teknik dalam melariskan barang jualan dengan menggunakan kemudahan TMK. Hal ini demikian kerana usahawan mampu memperolehi pendapatan tinggi sekiranya mereka memanfaatkan peluang pasaran produk mereka dengan menggunakan teknik pemasaran yang terkini iaitu secara e-dagang (Ahmad Firdause & Mohd Rafi, 2017). Kepesatan kemudahan teknologi dilihat dapat memudahkan urusan semua pihak sama ada pengusaha atau pembeli khususnya untuk mengakses perniagaan dan pembelian secara dalam talian. Pasaran e-dagang di Malaysia adalah antara yang sedang berkembang pesat di Asia Tenggara ekoran daripada peningkatan penggunaan telefon pintar dan internet sehingga mencatat pertumbuhan sebanyak 24.7 peratus pada tahun 2020 (GlobalData, 2020). Data ini

jelas membuktikan bahawa kemudahan TMK memberikan kesan yang positif terhadap pertumbuhan ekonomi negara khususnya melalui perniagaan secara digitalisasi.

Pemeriksaan Usahawan

Pemeriksaan didefinisikan sebagai sesuatu yang terkenal, berdaulat, kuat, hebat dominan dan sebagainya (Kamus Dewan Edisi Keempat). Menurut World Bank (2007), pemeriksaan bermaksud sebuah kemahiran yang dimiliki oleh seseorang individu ataupun sesebuah kumpulan untuk melakukan sesuatu pemilihan dan mentransformasikan pilihan tersebut kepada sebuah pelaksanaan yang akan mendatangkan hasil yang dikehendaki. Di samping itu, pemeriksaan didefinisikan sebagai sebuah bentuk pengawalan keputusan bagi individu atau kumpulan, perubahan seseorang individu atau komuniti serta pembuat keputusan dalam melakukan sesuatu pilihan. Selain itu, erti pemeriksaan turut membawa maksud sebagai sebuah proses dalam mendapatkan sesuatu (Malhotra et al., 2002) seperti kemahiran untuk mencapai pihak autoriti seperti bank, kemahiran dalam membuat keputusan terhadap isi rumah, kemahiran dalam membantu individu lain dan kemahiran dalam merancang secara berkesan (Solava dan Sabina, 2007).

Pada kurun ke-18, istilah usahawan diperkenalkan oleh Cantillon (Ab Aziz Yusof et al, 2004). Istilah tersebut adalah *entreprendre* yang berasal daripada bahasa Perancis. Ia membawa maksud memikul atau mencuba. Usahawan dikenali sebagai individu yang mempunyai sesebuah perniagaan untuk memperolehi hasil dalam bentuk nilai matawang dengan mencipta sesuatu aktiviti ekonomi lalu memproses dan mengeluarkan produk. Kebanyakan usahawan memulakan perniagaan menggunakan idea yang ringkas serta menjalankan operasi jualan secara kecil-kecilan. Kewujudan sumber yang terhad telah digunakan sebaik mungkin oleh para usahawan supaya dapat mengoperasikan perniagaan mereka.

Terdapat beberapa kepentingan pemeriksaan dalam aspek keusahawanan. Noor Carmelita (2015) menjelaskan antaranya adalah dapat mengukuhkan tahap kefahaman seseorang individu terhadap ideologi, perwatakan dan nilai. Tambahan pula, kebergantungan diri dan modal adalah perspektif penting dalam aspek pemeriksaan. Oleh itu, pemeriksaan adalah sangat penting bagi melihat kecekapan aktiviti keusahawanan terhadap usahawan B40. Hal ini kerana, ekonomi negara dapat dibangunkan dengan baik melalui kecekapan usahawan B40 dalam konteks pemeriksaan serta usahawan B40 dapat meningkatkan kemahiran diri mereka dalam aktiviti keusahawanan.

Connell (2015) berpendapat bahawa pemeriksaan adalah sebuah keyakinan terhadap diri sendiri dan mengetahui cara untuk memperolehi sumber-sumber yang diperlukan walaupun sumber-sumber tersebut adalah terhad. Oleh itu, beliau menjelaskan bahawa terdapat tiga langkah yang diperlukan oleh usahawan untuk berjaya dalam aktiviti keusahawanan ini. Pertama, jangan menjadikan halangan sebagai titik terakhir kejayaan untuk masa hadapan dan sentiasa bertekad untuk semakin melangkah ke hadapan. Seterusnya, usahawan perlu sentiasa bersikap terbuka supaya sentiasa bersedia untuk mempelajari sesuatu perkara baru yang perlu diketahui dalam aktiviti keusahawanan. Ketiga, usahawan perlu mempunyai pelbagai perancangan lain seperti mengambil inisiatif untuk menjalankan sesuatu perkara sekiranya perancangan awal tidak membuahkan hasil.

Di samping itu, Shipley (2015) turut menyatakan pendapat beliau mengenai kaedah untuk memperkasakan usahawan. Pertama, pihak berautoriti boleh menyediakan pelbagai program yang sesuai dengan hala tuju organisasi mereka. Seterusnya, pihak berwajib juga boleh menawarkan pelbagai peluang pekerjaan melalui kursus keusahawanan khususnya kepada mereka yang kehilangan punca pendapatan. Tambahan pula, pihak kerajaan juga perlu menggalakkan golongan muda untuk menyertai dunia keusahawanan. Melalui program-

program seperti ini, golongan muda akan lebih berminat untuk melibatkna diri dalam bidang keusahawanan dengan menjadikannya sebagai sebuah kerjaya pada masa hadapan.

Hazel dan Sally (2000) menjelaskan bahawa dalam membangunkan sesebuah negara, pemerksaan usahawan B40 merupakan salah sebuah langkah yang efisien kerana golongan ini terlibat dalam proses membuat keputusan dan mempunyai kemahiran asas dalam mencapai kesaksamaan, keamanan dan pembangunan yang sejahtera. Bukan itu sahaja, mereka turut mempunyai kemampuan untuk melakukan perubahan dalam sosio-ekonomi melalui peningkatan taraf hidup dan peningkatan pendapatan (NiagaTimes, 8 Januari 2021). Secara intihanya, pemerksaan dan keusahawanan adalah saling melengkapi (Vijayalakshmi & Prajeetha, 2008) bagi membangunkan sesebuah negara.

KERANGKA KONSEPTUAL

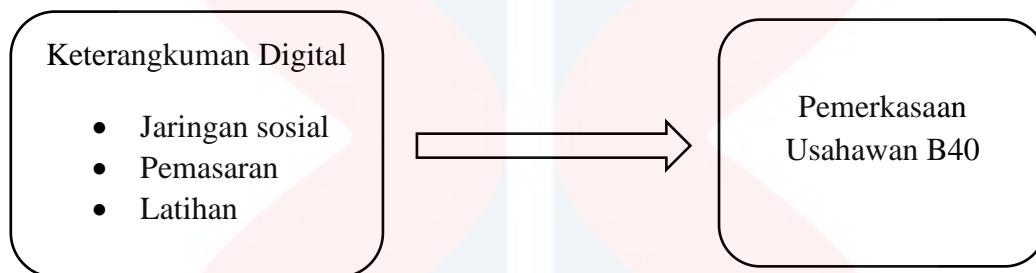

Rajah 1: Kerangka Konseptual Ketereakangmuna Digital dan Pemerksaan Ushawan B40

Kerangka konseptual menjelaskan tentang pemboleh ubah bebas iaitu keterangkuman digital yang diukur dengan tiga dimensi; jaringan sosial, pemasaran dan latihan dan akan dianalisis untuk menguji sumbangan dan kesignifikan antara pemboleh ubah bebas dengan pemboleh ubah terikat.

METODOLOGI

Kaedah tinjauan (*survey*) telah digunakan dalam kajian ini dan merupakan kajian inferensi dengan menggunakan data-data kuantitatif yang dipungut melalui soal selidik. Data-data yang diperoleh daripada sampel ini kemudiannya dianalisis dan dipersembahkan dengan deskriptif statistik dan ujian signifikan. Keputusan ujian-ujian statistik seterusnya akan memberi kesimpulan terhadap ciri-ciri populasi yang dikaji. Sebanyak 618 orang usahawan B40 yang berumur antara 18 ke atas dijadikan unit sampel kajian. Usahawan B40 yang akan dijadikan responden mesti memenuhi kriteria yang telah ditetapkan oleh pengkaji iaitu; mempunyai perniagaan berdaftar dan menjalankan perniagaan di negeri Selangor (Hulu Langat, Kuala Langat, Kuala Selangor, Sabak Bernam, Sepang). Secara amnya, usahawan ini adalah terdiri daripada para usahawan Perusahaan Kecil dan Sederhana (SME) daripada pelbagai sektor.

Sampel kajian dipilih berdasarkan dua teknik pensampelan iaitu teknik pensampelan berkelompok (*cluster sampling*) dan Teknik pensampelan bertujuan (*purposive sampling*). Teknik pensampelan berkelompok digunakan bagi mendapatkan secara rawak usahawan B40 di negeri Selangor yang terdiri daripada beberapa kawasan yang besar. Teknik pensampelan bertujuan digunakan kerana tujuan kajian ini adalah fokus kepada kumpulan usahawan B40 yang memenuhi kriteria yang ditetapkan oleh pengkaji. Bilangan sampel kajian bagi setiap daerah kemungkinan sama iaitu 120 orang bagi setiap Kawasan atau kemungkinan tidak sama bilangannya mengikut jumlah usahawan B40 yang terdapat dalam kawasan tersebut.

Seterusnya, kaedah literatur digunakan untuk mengenal pasti domain-domain keterangkuman digital serta membentuk instrumen kajian. Analisis statistik deskriptif dan inferensi juga akan dijalankan bagi mendapatkan hasil kajian yang terperinci dengan menggunakan perisian SPSS (*Statistical Package for Social Sciences*). Hipotesis kajian akan dianalisis dengan analisis faktor penerokaan untuk menentukan faktor atau dimensi yang terbentuk daripada senarai kriteria penilaian yang sebenar bagi mewakili kelompok subjek kajian.

DAPATAN KAJIAN

Analisis Deskriptif Profil Responden

Berdasarkan kajian yang dijalankan, seramai 336 adalah usahawan lelaki (54.4%) dan selebihnya adalah usahawan wanita dengan jumlah seramai 282 orang (45.6%). Kebanyakan kelompok usahawan B40 yang menjadi responden kajian ini juga merupakan kaum Melayu dengan jumlah sebanyak 556 orang (90%). Dari segi status, kebanyakan mereka juga telah berkahwin, namun terdapat juga yang masih bujang, ibu tunggal serta bapa tunggal. Dari aspek taraf pendidikan, seramai 328 orang mempunyai Sijil Pelajaran Malaysia (SPM), diikuti 149 mempunyai Sijil/STPM/Diploma, dan selebihnya mempunyai kelulusan UPSR, SRP/PMR, Sarjana Muda dan Sarjana. Jadual 1 menjelaskan secara terperinci taburan demografi responden.

Jadual 1: Taburan Demografi Responden

Item	Bilangan	Peratusan
Jantina		
Lelaki	336	54.4
Perempuan	282	45.6
Bangsa		
Melayu	556	90.0
Cina	26	4.2
India	28	4.5
Bumiputera Sabah/Sarawak	5	0.8
Lain-lain	3	0.5
Status Perkahwinan		
Bujang	175	28.3
Berkahwin	368	59.5
Ibu tunggal	50	8.1
Bapa tunggal	25	4.0
Taraf Pendidikan		
UPSR	16	2.6
SRP/PMR/PT3	83	13.4
SPM	328	53.1
Sijil/STPM/Diploma	149	24.1
Sarjana Muda	40	6.5
Sarjana	2	0.3

Analisis Inferens

Hasil ujian inferensi melihat hubungan antara pemboleh ubah-pemboleh ubah peramal yang dapat mengenal pasti pemerksaan yang dilalui oleh responden. Pelbagai faktor diandaikan dapat memperkasakan usahawan B40. Untuk tujuan tersebut, ujian regresi pelbagai (*multiple regression*) dengan kaedah *stepwise* telah digunakan bagi meninjau sumbangan pemboleh ubah bebas yang menyumbang terhadap perubahan varian pemboleh ubah terikat. Kaedah ini juga akan menentukan kedudukan pemboleh ubah yang memberikan sumbangan utama. Tahap signifikan untuk ujian hipotesis dalam kajian ini adalah berdasarkan aras $p < 0.05$.

Hipotesis

Hipotesis 1: Keperluan keterangkuman digital (jaringan sosial, pemasaran, latihan) mempunyai hubungan yang signifikan dengan pemerksaan usahawan B40.

Diandaikan dimensi bagi pemboleh ubah keperluan keterangkuman digital (jaringan sosial, pemasaran, latihan) mempunyai hubungan yang signifikan dengan pemerksaan usahawan B40. Hasil ujian regresi pelbagai dengan menggunakan kaedah *step wise* menunjukkan bahawa hanya dua dimensi sahaja iaitu jaringan sosial dan pemasaran yang menyumbang kepada pemerksaan dengan sebanyak 65 peratus varians. ($F = 565.135$, $p < 0.05$; R^2 adjusted = .65).

Sementara itu, dimensi latihan didapati tidak menyumbang kepada varians pemerksaan dengan bacaan signifikan $p = .383$. Daripada Jadual 2 juga dapat dilihat bahawa pekali regresi menunjukkan kedua-dua dimensi jaringan sosial ($\beta = .58$) dan pemasaran ($\beta = .26$) memberi sumbangan positif terhadap pemerksaan usahawan B40. Peningkatan dalam setiap unit jaringan sosial akan menyumbangkan sebanyak .58 unit dalam pemerksaan usahawan B40. Begitu juga dengan peningkatan dalam setiap unit pemasaran akan menyumbangkan sebanyak .26 unit dalam pemerksaan usahawan B40. Ini menjelaskan bahawa jaringan sosial dan pemasaran yang baik mampu menyumbang kepada pemerksaan usahawan B40 tanpa mempunyai latihan yang banyak. Jadual 2 menjelaskan taburan dengan lebih lanjut.

Jadual 2: Hubungan Dimensi Keperluan Keterangkuman Digital Jaringan Sosial, Pemasaran, Latihan) dengan Pemerksaan Usahawan B40

Pemboleh ubah (Dimensi)	R ² Adjusted	R ² Perubahan	Beta	Nilai t	Signifikan
Jaringan Sosial	.63	-	.58	12.494	.000*
Pemasaran	.65	.02	.26	5.429	.000*

*Signifikan pada aras 0.05 ($F = 565.135$, $p < 0.05$; R^2 adjusted = .65)

KESIMPULAN

Umumnya, kertas kerja ini menerangkan tentang keperluan keterangkuman digital dan sumbangannya terhadap pemerksaan usahawan B40. Tiga dimensi telah dikenal pasti bagi mengukur keperluan keterangkuman digital dalam kajian ini iaitu jaringan sosial, pemasaran dan latihan. Hasil ujian regresi menunjukkan bahawa terdapat hanya dua dimensi iaitu jaringan sosial dan pemasaran mempunyai hubungan yang signifikan dan menyumbang kepada pemerksaan. Justeru, usahawan B40 yang mempunyai jaringan sosial yang baik dengan

pembekal dan pelanggan serta konsisten dalam melakukan pemasaran secara dalam talian, akan lebih cenderung untuk memperkasakan perniagaan mereka. Walau pun tanpa latihan berkaitan penggunaan ICT atau keusahawanan, namun ia tidak menghalang untuk usahawan B40 terus maju dan memperkasakan perniagaan. Selain itu, usahawan B40 perlu mempertingkatkan pengetahuan dalam bidang teknologi dalam menjalinkan jaringan sosial serta menguruskan perniagaan dengan teknik pemasaran yang efisien serta sentiasa bersedia untuk bersaing dalam pasaran seiring dengan arus perkembangan ekonomi. Perkara ini secara tidak langsung membantu dalam memperkukuh dan memperkasa usahawan B40 sebagai kelompok masyarakat dan ummah yang berdaya saing dalam perniagaan.

PENGHARGAAN

Penghargaan diberikan kepada Skim Geran Penyelidikan Fundamental 2020 (FRGS) di bawah Kementerian Pengajian Tinggi (KPT). No. Geran: FRGS/1/2020/SS0/KUIS/02/2, Universiti Islam Selangor (UIS).

RUJUKAN

- Ab. Aziz Yusof & Zakaria Yusof. (2004). *Prinsip Keusahawanan*. (2nd ed.). Prentice Hall.
- Ahmad Firdause Md Fadzil, & Mohd Rafi Yaacob. (2017). Psikologi usahawan: Peranan motivasi kepada penciptaan perniagaan baharu e-dagang. *Journal of Business and Social Development*, 5(1), 49-59.
- Alzahrin Alias. (2022, Ogos 11). SME Bank buka peluang PKS tembusi pasaran global. *Berita Harian Online*. <https://www.bharian.com.my/bisnes/usahawan/2022/08/987240/sme-bank-buka-peluang-pks-tembusi-pasaran-global>
- Bernama. (2020, Ogos 24). PKS perlu tingkatkan lagi digitalisasi perniagaan. *Berita Harian Online*. <https://www.bharian.com.my/bisnes/lain-lain/2020/08/724189/pksperlu-tingkatkan-lagi-digitalisasi-perniagaan>
- Connell, J. (2015, June 30). *3 steps to become the empowered entrepreneur you want to be*. Entrepreneur. <https://www.entrepreneur.com/article/246962>
- Crandall, M., & Fisher, K. E. (2009). *Digital inclusion: Measuring the impact of information and community technology*. American Society for Information Science and Technology by Information Today.
- Faradillah Iqmar Omar, Umami Munirah Syuhada Mohamad Zan, Mawar Murni Yunus, Nor Azlili Hassan & Nur Hafidzah Nor Hasim. (2021). Keterangkuman digital dan usahawan B40: Analisis sorotan literatur. In *Proceeding of 8th International Research Management and Innovation Conference (8th IRMIC 2021)* (pp 192-202). Selangor: Kolej Universiti Islam Antarabangsa Selangor. e-ISSN: 2710-6772.
- GlobalData Pic. (2020). *Covid-19 accelerates e-commerce growth in Malaysia*. Retrieved from <https://www.globaldata.com/covid-19-accelerates-e-commerce-growth-malaysia-says-globaldata/>
- Hache, A. & Cullen, J. (2009). *ICT and Youth at Risk: How ICT-driven initiatives can contribute to their socio-economic inclusion and how to measure it*. JRC Scientific and Technical Reports.
- Hazel, R. & Sally, B. (2000). *Gender and development: Concepts and definitions*. Department for International Development (DFID): Institute of Development Studies.
- Jabatan Perangkaan Malaysia. (2022). *Kenyataan media penggunaan dan capaian ICT oleh individu dan isi rumah 2021*. https://www.dosm.gov.my/v1/uploads/files/5_Gallery/2_Media/4_Stats%40media/4-

[Press Statement/2022/04.%20APRIL/PENGGUNAAN%20DAN%20CAPAIAN%20ICT%20OLEH%20INDIVIDU%20DAN%20ISI%20RUMAH%202021.pdf](https://prpm.dbp.gov.my/cari1?keyword=terangkum)

- Kamus Dewan Edisi Keempat. (n.d.). *Keterangkuman*. In Dewan Bahasa dan Pustaka. Retrieved September 12, 2022, from <https://prpm.dbp.gov.my/cari1?keyword=terangkum>
- Malhotra, A., Schuler, S.R., & Boender, C. (2002). *Measuring women's empowerment as a variable in International Development*. The World Bank, Washington DC.
- Muhammad Wafi Ramli, & Sharifah Rohayah Sheikh Dawood. (2021). Faktor golongan muda Malaysia membeli dalam talian: Satu tinjauan awal. *Journal of Social Sciences and Humanities*, 18(5), 79-90.
- NiagaTimes. (2021, 8 Januari). *Platform koperasi dan francais untuk usahawan wanita, warga emas, B40 dan OKU*. NiagaTimes. <https://www.niagatimes.com/platform-koperasi-dan-francais-untuk-usahawan-wanita-warga-emas-b40-dan-oku/>
- Noor Carmelita Mohamed Noor. (2015). *Wanita dan pemerksaan: Satu kajian kes penglibatan isteri nelayan dalam persatuan KUNITA Sinar Mutiara di Pulau Pinang*. (Unpublished master's thesis). Universiti Sains Malaysia, Pulau Pinang, Malaysia.
- Shipley, E. (2015, October 27). *4 ways to empower tomorrow's entrepreneurs*. TriplePundit. Retrieved from <https://www.triplepundit.com/story/2015/4-ways-empower-tomorrows-entrepreneurs/30861>
- Solava, I., & Sabina, A. (2007). *Agency and empowerment: A proposal for internationally comparable indicators*. OPHI Working Paper, Oxford Poverty and Human Development Initiative, Oxford.
- Vijayalakshmi, G., & Prajeetha, B. (2008). Empowerment of women through entrepreneurship: Empirical findings. In Rathakrishnan, L. (Ed.), *Empowerment of women through entrepreneurship*. Gyan Publishing House.
- Wartawan BH. (2022, Julai 27). Sektor PKS sumbang RM572.6 bilion kepada KDNK. *Berita Harian Online*. <https://www.bharian.com.my/bisnes/lain-lain/2022/07/980802/sektor-pks-sumbang-rm5726-bilion-kepada-kdnk>
- Zaleha Yazid, Che Aniza Che Wel, & Nor Asiah Omar. (2016). Persepsi mahasiswa terhadap urusan pembelian atas talian. *Jurnal Personalia Pelajar*, 19(2), 17-25.

UNIVERSITI
MALAYSIA
KELANTAN

Penerapan Nilai-nilai Pendidikan Islam dalam Pemantapan Keperibadian Akhlak Pelajar

Nurul Ilmuni Hayati Che Aziz
Fakulti Pendidikan, Universiti Kebangsaan Malaysia
p111878@siswa.ukm.edu.my

Hafizhah Zulkifli
Fakulti Pendidikan, Universiti Kebangsaan Malaysia
hafizhah_zulkifli@ukm.edu.my

ABSTRACT

A good self-personality reflects admirable moral values and discipline. The Prophet Muhammad SAW has prescribed that one of the main purposes of his da'wah is to spread and invite mankind to apply the pure values of Islam to be virtuous. Knowledge and moral practise based on monotheism is a strategy to protect the personality and dignity of human beings from being caught up in life-threatening acts. The application of elements of pure Islamic values in the education system is important today to produce disciplined students. Strengthening the moral personality in oneself can protect oneself from committing acts that are reprehensible and despicable in terms of religion. Islamic education is a good, noble, and holy element in terms of all religions found in the world and forms a more harmonious human life. The symptoms of moral and disciplinary deterioration that occur today are a very serious problem, worrying and need to be resolved and addressed by those responsible. The purpose of writing this article is to discuss the importance of providing awareness and understanding of the importance of the value of Islamic education spread by the Prophet SAW to strengthen the moral personalities of students who are admirable and raise the civilization of excellent human beings. Excellence here refers to the success of life in the worldly and ukhrawi aspects later. Islamic moral education is of a perfect and absolute nature, which is revealed from the Qur'an and Sunnah. Thus, the strengthening of moral personality through Islamic values in education also allows us to address the issue of moral decay that occurs today.

Keywords: *Islamic education, morals, pure values, social symptoms, da'wah.*

ABSTRAK

Keperibadian diri yang baik mencerminkan nilai akhlak dan disiplin yang terpuji. Nabi Muhammad SAW telah mensyariatkan salah satu tujuan utama dalam dakwah baginda ialah menyebarkan dan mengajak umat manusia menerapkan nilai-nilai murni Islam supaya berakhlak mulia. Pengetahuan dan pengamalan akhlak berdasarkan ilmu tauhid merupakan strategi untuk menjaga keperibadian dan maruah diri manusia daripada terjebak dengan perbuatan yang boleh mengancam nyawa. Penerapan unsur nilai-nilai murni Islam dalam sistem pendidikan adalah penting pada hari ini untuk melahirkan pelajar yang berdisiplin. Pemantapan keperibadian akhlak dalam diri dapat melindungi diri daripada melakukan perbuatan yang tercela dan hina di sisi agama. Pendidikan Islam merupakan elemen yang baik, mulia, suci dari segi semua agama yang terdapat di dalam dunia dan membentuk kehidupan manusia yang lebih harmoni. Gejala kemerosotan akhlak dan disiplin yang berlaku pada hari ini merupakan suatu masalah yang sangat serius, membimbangkan dan perlu diselesaikan serta ditangani oleh pihak yang bertanggungjawab. Penulisan artikel ini bertujuan untuk membincangkan perihal memberi kesedaran dan pemahaman mengenai kepentingan nilai ilmu Pendidikan Islam yang disebar oleh Rasulullah SAW bagi memantapkan keperibadian akhlak pelajar yang terpuji dan mengangkat peradaban insan-insan yang cemerlang. Kecemerlangan di sini merujuk kepada kejayaan hidup dalam aspek

duniawi dan ukhrawi kelak. Pendidikan akhlak Islam adalah bersifat sempurna dan mutlak yang ber Wahyu daripada al-Quran dan al-Sunnah. Maka, pemantapan keperibadian akhlak melalui nilai-nilai Islam dalam pendidikan juga membolehkan menangani isu keruntuhan akhlak yang berlaku pada masa kini.

Kata kunci: Pendidikan Islam, akhlak, nilai-nilai murni, gejala sosial, dakwah.

PENGENALAN

Dewasa ini, aliran proses dalam sistem pendidikan abad sering dihubungkan dengan unsur nilai-nilai murni dan pembentukan akhlak pelajar. Pendidikan merupakan salah satu aspek penting dan dititikberatkan oleh Islam. Ianya dibuktikan dengan terdapatnya dalam bentuk ayat pertama yang terdapat dalam kitab yang suci iaitu *kalamullah* al-Quran yang diturunkan kepada Nabi Muhammad SAW. Ilmu dalam setiap pendidikan yang disampaikan bukan hanya pertukaran pengisian maklumat semata-mata dari seorang guru kepada pelajar, malah ianya merupakan suatu kaedah bagi membentuk pelajar yang cemerlang seperti yang dituntut dalam nilai-nilai Islam. Begitulah juga dengan pengetahuan ilmu Pendidikan Islam di dalam kehidupan amatlah penting bagi membentuk sahsiah seseorang Muslim yang beramal soleh.

Pengertian surah pertama al-Quran yang diturunkan oleh Malaikat Jibril AS kepada Rasulullah SAW adalah mengenai pendidikan. Kepentingan, kepelbagaian dan faedah pendidikan disebut secara langsung dan tidak langsung dalam banyak surah. Pembaca al-Quran sering diminta untuk menggunakan akal untuk belajar dan memahami maksudnya. Mereka perlu menjana minda, penglihatan, pendengaran, kemampuan lisan dan perbuatan mereka secara dinamik untuk memperoleh pengisian yang terperinci. Perkara-perkara ini dipraktikkan dan dimanifestasikan semasa hidup Rasulullah SAW yang dikasihi, para sahabat dan generasi awal sarjana Muslim semasa era kegemilangan tamadun Islam. Hal ini untuk menunjukkan bahawa Islam sangat teliti dalam aspek pembangunan, kemajuan dan pencapaian manusia di dunia sekarang dan akhirat.

Wujudnya semangat untuk mencapai pendidikan di tahap kelas pertama di serantau dunia, sistem pendidikan terutamanya di Malaysia sering menghadapi pelbagai cabaran, kekangan dan arus transformasi kemodenan dari semasa ke semasa menjelang tahun 2025. Instruksi pengajaran yang efisien dapat dicapai sekiranya organisasi pendidikan memfokuskan pemikiran minda yang kritis kepada pelajar dengan tidak mengubahnya menjadi bahan ujian. Bagi skop kaedah dalam Pembelajaran Abad Ke-21 (PAK21) sering digunakan oleh para guru ialah simulasi, teknik perbincangan, demonstrasi, persembahan, hiburan dan lain-lain lagi. Sebaik-baiknya, kesanggupan para guru untuk menggabungkan pelbagai cara dan sumber adalah disarankan bagi membentuk generasi yang mempunyai wawasan hidup dengan menerapkan unsur nilai-nilai murni ke dalam diri individu.

Aspek keperibadian akhlak merupakan antara sudut yang dititikberatkan dalam ilmu Pendidikan Islam selain dari al-Quran, akidah dan ibadah. Hal ini selari dengan hala tuju Pendidikan Islam yang tersendiri iaitu membentuk atau merencanakan seseorang yang dapat memberi manfaat sebagai seorang khalifah Allah SWT yang dapat memikul sifat bertanggungjawab dan jujur yang telah diperintahkan oleh-Nya. Justeru itu, mengenai isu-isu pendidikan di sekolah, peranan guru adalah sebagai petugas kurikulum yang mempunyai peranan sebagai petunjuk yang profesional kepada peribadi pelajar supaya lebih menerapkan akhlak, berkemahiran dan mempunyai keperibadian yang lebih unggul.

Menurut Ab Halim Tamuri et al. (2010) menyatakan bahawa arah tuju proses dalam membentuk akhlak pelajar masa kini dan masa depan adalah tanggungjawab yang terbeban dengan berat bagi pendidik, terutamanya para guru Pendidikan Islam. Ianya disebabkan masyarakat sekeliling masa kini meletakkan satu harapan yang terlalu tinggi kepada guru sebagai berperanan mengembangkan pencapaian potensi dan mendidik penuh anak-anak mereka hanya di sekolah. Hal ini juga melibatkan mengenai potensi afektif, kognitif, psikomotor, serta bahkan para guru memikul tanggungjawab untuk merealisasikan serta melaksanakan pencapaian Falsafah Pendidikan Islam (FPI) dan Falsafah Pendidikan Kebangsaan (FPK). Penghayatan dan pengetahuan mengenai nilai-nilai murni akan menentukan jenis manusia yang diinginkan. Hal ini menunjukkan bahawa guru mempunyai kuasa dan pengaruh dalam membentuk pelajar, terutamanya bagi membentuk hal keperibadian Muslim mengenai keimanan, pengetahuan, ibadah, akidah dan penghayatan berunsurkan nilai akhlak (Fathiyah, 2010).

Unsur akhlak menunjukkan keperibadian diri yang asal dan menghasilkan perbuatan secara menyeluruh tanpa menggunakan pemikiran yang rasional atau ketelitian. Emosi yang diciptakan oleh Allah SWT ke dalam jiwa manusia mempunyai unsur-unsur kebaikan (*taqwa*) dan unsur-unsur buruk (*fasiq*). Maka, kecenderungan untuk mengenalpasti antara kedua-dua elemen tersebut memberi peluang kepada seseorang individu berkenaan untuk memilihnya secara tepat. Berkelakuan baik atau buruk adalah merujuk terhadap pengukuran kerohanian dalam setiap diri individu yang bertegas melakukannya. Menurut kajian dari Rohana Tan dan Norhasni (2014) berpandangan bahawa moral adalah faktor dalaman (jiwa) seseorang individu sedangkan perbuatan ialah faktor luaran. Penerapan keperibadian akhlak yang baik akan membawa kepada perbuatan yang baik dan pada masa yang sama akan menyebabkan seseorang itu tergolong dalam masyarakat yang berperilaku baik dan dianggap mulia.

PERNYATAAN MASALAH

Institusi alam pendidikan kini sememangnya menjadi pendorong utama pembentukan minda pelajar dalam mengenali kebaikan dan keburukan sesuatu. Status dan peranan guru sudah pasti dapat membentuk pelajar ke arah kewujudan peradaban manusia yang lebih gemilang dan bertoleransi. Peranan itu telah menjadi peranan besar dan mencabar. Hal ini kerana perkembangan dan kemajuan industri yang pesat dinikmati pada era globalisasi masa kini telah menonjolkan pelbagai cabaran bagi melahirkan generasi akan datang terutamanya kepada ibu bapa dan para pendidik. Pendekatan ini bagi menangani dunia maya dan arus kemodenan teknologi maklumat kini, tidak diragukan lagi bahawa penerapan ilmu pengetahuan dalam bidang pendidikan juga harus diperluaskan seiring dengan pencapaian kemajuan ini. Hal ini disebabkan para pelajar globalisasi semasa khususnya tidak lagi dapat menerima proses belajar dan mengajar dengan cara lama iaitu yang hanya mendengar dan melihat guru di hadapan. Mereka hanya menganggap pembelajaran hanya di sekolah dan tidak boleh diteruskan di rumah. Maka, dengan cara ini mereka membosankan dan membuat mereka tidak berminat untuk memperhatikan apa yang guru katakan kepada mereka.

Sektor pendidikan juga diperlukan untuk proses-proses pembaharuan supaya generasi angkatan seterusnya tidak terlepas dan dapat memimpin cabaran alam semesta ini (duniawi) diiringi akhirat dengan visi yang mutlak. Oleh itu, Islam sangat memberi ketegasan dan penekanan terhadap pembelajaran yang perlu diterapkan kepada pemikiran generasi kini, terutamanya golongan muda seperti pelajar. Mereka perlu diberi bimbingan dan dididik sesuai dengan arena dunia supaya dapat mendorong ke arah pembangunan negara dan diikuti menjadi manusia yang unggul dalam kehidupan kelak.

Buerah Tunggak et al. (2015) dalam kajiannya bahawa pada zaman globalisasi kini terdapat kepelbagaian masalah akhlak dan etika yang telah bergelombang dalam kehidupan manusia. Ianya bukan sahaja berlaku dalam kalangan orang muda seperti remaja, tetapi ia juga melanda semakin hampir semua kumpulan dan setiap kategori isu sosial seperti kes jenayah kolar putih, rasuah, salah laku antara pendidik dan pelajar serta penyalahgunaan kuasa. Terdapat pelbagai pilihan kenakalan sosial yang melibatkan para pelajar mulai daripada permasalahan ringan seperti ponteng kelas dan sekolah, lewat ke sekolah dan melanggar peraturan-peraturan sekolah serta diikuti dengan perlakuan tidak bermoral seperti memerangi guru, membuli, merokok dan sebagainya. Kemudian, mereka (pelajar) melakukan kesalahan perbuatan etika dan disiplin yang serius seperti perbuatan seks bebas, kehamilan dan kelahiran anak yang dilahirkan secara luar nikah, ketagihan dadah pembunuhan bayi dan pemerkosaan yang sering dilaporkan di media massa hampir setiap hari.

Kajian terdahulu menunjukkan bahawa pembelajaran dan pengetahuan dalam bab sosial dalam kalangan para pelajar sangat signifikan dengan permasalahan disiplin yang telah wujud hampir di setiap sekolah. Bagi pelajar mahupun remaja yang menghadapi masalah kes disiplin mempunyai sebab-sebab tertentu. Antaranya ia disebabkan oleh pendidikan ajaran guru, penjagaan ibu bapa, terpengaruh dengan rakan-rakan dan media sosial terutamanya gaya keterampilan serta perilaku kehidupan seorang artis. Saban hari, permasalahan yang melibatkan disiplin ini menyebabkan moral pelajar akan menjadi semakin rosak. Tetapi, ianya belum mempunyai kajian yang dilakukan bagi mengkaji aspek-aspek dalaman seperti ini secara menyeluruh, terutama mengenai kaedah pengajaran dan pembelajaran sosial bagi pembentukan dan pemantapan akhlak pelajar yang sempurna. Merujuk kepada isu-isu diuraikan sebelum ini, moraliti merupakan bahagian penting bagi membentuk generasi pelapis muda yang bersedia dan mampu membangun negara secara berwibawa dan holistik.

Peranan dan fungsi pembelajaran dalam bidang sosial untuk membentuk akhlak yang mulia dalam diri setiap pelajar tidak hanya berkaitan dengan cara memindahkan fakta dan pengisian ajaran ilmu Islam ke dalam minda dan pemikiran pelajar serta mengharapkan para pelajar menyatakan fakta berkenaan dalam ujian penilaian untuk mengarahkan kejayaan mereka dalam subjek-subjek tertentu sahaja. Meskipun faktor pembelajaran yang memainkan peranan penting dan dikendalikan oleh pelajar, pengamalan nilai-nilai murni dalam kehidupan segelintir pelajar merupakan aspek yang mesti diberi tumpuan serta fokus utama terhadap amalan bab pendidikan di negara ini. Ianya diberi perhatian terutamanya dalam bidang soal pembelajaran mengenai hak asasi manusia dan sosial. Proses pembelajaran isu sosial di negara ini secara amnya lebih memfokuskan kepada prinsip umum sistem pembelajaran sosial, persoalan mengenai falsafah dan juga organisasi kurikulum berbeza dengan penyelidikan tentang intipati kaedah pendidikan itu sendiri, iaitu bagaimana anak belajar dan menerima ilmu yang dipelajari.

Isu mengenai masalah gejala atau simptom sosial dalam kalangan pelajar kini memberi impak yang berat kepada pelajar itu sendiri, kemajmukan masyarakat dan kemakmuran negara pada masa akan datang nanti. Seseorang yang bergelar pelajar merupakan salah satu aset penting negara yang sangat berharga kerana pergolakan sesebuah negara itu terikat pada situasi pelajarinya sekarang. Pemantapan keperibadian akhlak yang baik dan sempurna diperhatikan dengan hormat serta dipandang tinggi oleh masyarakat, sementara moral dan etika yang buruk akan dipandang serong dan rendah. Penubuhan institusi kekeluargaan akan hancur kesan daripada tidak berpegang dengan akhlak yang menjurus ke arah kebaikan. Terdapat segelintir anak-anak kurang mendapat perhatian dan sering kali mudah terjerumus dalam perbuatan yang negatif akibat kehilangan tumpuan dan perhatian dari ibu bapa mereka. Kesan kepada

masyarakat pula ialah mereka akan berpecah belah, mementingkan diri sendiri, melakukan perkara tanpa pertimbangan agama. Oleh itu, akhlak berkait rapat dengan kenaikan dan kejatuhan sesebuah negara.

TUJUAN KAJIAN

Penulisan artikel ini bertujuan untuk membincangkan penerapan nilai-nilai pendidikan Islam dalam pemantapan keperibadian akhlak pelajar dan dijadikan contoh teladan yang berguna kepada masyarakat lain. Aspek akhlak merupakan satu asas yang penting dalam ajaran Islam. Ianya merupakan satu tonggak utama untuk membina keperibadian manusia terutamanya kepada pelajar. Bagi merealisasikan kemajuan dan perkembangan dalam sektor pendidikan pada abad ke-21, permasalahan terhadap keruntuhan dan kemusnahan akhlak menjadi kian serius, terutamanya dalam golongan pelajar.

Justeru itu, para guru Pendidikan Islam berperanan menjadi perantaraan penting dalam membina sifat keperibadian pelajar perlu meneliti, memahami dan dapat menguasai pelbagai kaedah pengajaran dan pembelajaran yang serasi dengan diri pelajar dan sesuai untuk menentukan pemantapan akhlak diterapkan dengan kekuatan dan berkesan. Hal ini sejajar dengan inspirasi Pelan Pembangunan Pendidikan Malaysia 2013 – 2025 bagi membentuk dan melahirkan pelajar yang memiliki kepercayaan agama yang kuat dan penghayatan, pengetahuan serta pengamalan akhlak yang jitu lagi mendalam.

Maka, kepentingannya adalah melahirkan insan yang berdisiplin dan berakhlak mulia kepada agama, bangsa dan negara kelak. Selain itu, penerapan nilai-nilai Pendidikan Islam juga adalah untuk memantapkan akhlak adalah wahana penting bagi menyelesaikan masalah akhlak, moral dan membentuk keperibadian insan yang mempunyai sifat yang unggul dan baik. Penumpuan terhadap nilai-nilai murni dalam Pendidikan Islam ialah terang, lancar dan jelas. Hal ini disebabkan Pendidikan Islam memberi penekanan dan bertujuan untuk mengembangkan dan mewujudkan serta melahirkan manusia secara seimbang dan bersepadu agar dapat melaksanakan peranan manusia sebagai hamba dan khalifah Allah SWT di muka bumi ini.

OBJEKTIF KAJIAN

Dalam penulisan ini juga terdapat objektif kajian yang ingin dicapai, iaitu:

- i) Mengenalpasti penerapan nilai-nilai Pendidikan Islam dalam diri pelajar.
- ii) Mengenalpasti faktor-faktor pengamalan Pendidikan Islam yang mempengaruhi pemantapan keperibadian akhlak pelajar.

PERSOALAN KAJIAN

Penumpuan yang lebih jelas untuk menerangkan tujuan kajian, maka objektif-objektif yang dinyatakan di atas diperjelaskan lagi dalam bentuk persoalan kajian seperti berikut:

- i) Apakah penerapan nilai-nilai Pendidikan Islam dalam diri pelajar?
- ii) Apakah faktor-faktor pengamalan Pendidikan Islam yang mempengaruhi pemantapan keperibadian akhlak pelajar?

KAJIAN LITERATUR

Kementerian Pelajaran Malaysia (KPM) menyatakan objektif dan tujuannya dalam mata pelajaran Pendidikan Islam adalah agar pelajar dapat membaca dan menghafal surah-surah terpilih di dalam al-Quran, memahami dan mengetahui tentang sejarah keilmuan Islam, mempercayai dan merumuskan asas-asas iman, mengamalkan konsep dan teori-teori asas adab (*ta'dib*), ibadah serta berkebolehan membaca, menulis dan mengarang ayat atau teks menggunakan tulisan Jawi (Kementerian Pelajaran Malaysia, 2015). Pendidikan Islam adalah mata pelajaran yang dapat mengatur setiap individu untuk menjadi manusia yang sempurna atau berguna dan mempunyai kesedaran akan tanggungjawab terhadap semua urusan mahupun perkara di dunia dan akhirat. Ilmu pengetahuan Islam adalah panduan hidup untuk membimbing umat Islam sejagat ke arah kemuliaan, kecemerlangan, ketenangan, kebahagiaan termasuk diri, keluarga dan masyarakat. Di samping itu, pelajar hari ini adalah asset utama negara yang sangat berharga pada masa akan datang.

Kaedah pengajaran seseorang individu adalah kaedah pengajaran terkini dan sesuai untuk merealisasikan serta digunapakai dalam pengetahuan, penghayatan dan pengamalan dalam subjek Pendidikan Islam. Maka, dengan pendekatan seperti ini memberi pengharapan supaya dapat menjadi jurang perubahan ke arah positif atas dasar mengikut unsur perbezaan antara pelajar dan membantu merangsang perkembangan ideologi pemikiran pelajar. Kaedah pengajaran bermaksud semua aktiviti yang diarahkan oleh guru untuk memberi penyampaian kaedah pengajaran yang sistematik dan berkesan serta dapat diterima oleh pelajar. Ia juga memberi pelajar untuk mengakses fungsi pembelajaran yang diinginkan dan peralihan kelakuan pelajar. Seterusnya, ia berperanan membantu pelajar mendapatkan pengisian maklumat, kemahiran, tabiat, ilmu pengetahuan, minat, sikap dan nilai yang diperoleh.

Bagi pendekatan individu juga mahir melaksanakan tujuan utama sistem pendidikan, yang bukan hanya bagi melahirkan para pelajar yang berpotensi tinggi dalam bahagian kognitif. Tetapi yang paling utama lagi adalah melahirkan individu pelajar yang sanggup menegakkan nilai-nilai murni untuk dipertahankan dan dikembangkan. Oleh itu, tugas dan peranan guru bukan hanya untuk menyampaikan tujuan tetapi untuk membentuk cara proses pengetahuan dan tujuan dapat menukar gaya pemikiran, bentuk amalan dan sikap hidup berdasarkan pengetahuan yang bernas dan nilai-nilai yang cemerlang. Jika pendekatan seseorang individu dilatih melalui kaedah yang tepat, ia pasti dapat melahirkan pelajar berkualiti apabila diikuti dengan ukuran modal insan pada tahap kelas pertama yang bakal menggilap peradaban ummah sejati dan semangat kecintaan kepada negara Malaysia suatu hari nanti.

Noornajihan et al. (2017) menyenaraikan lapan kaedah pengajaran kenabian, yang merangkumi beberapa aspek, iaitu memanggil orang dengan cara yang terhormat, berbicara tentang sesuatu secara umum sebelum pergi ke arah yang spesifik, menyampaikan kuliah dengan jelas, lancar dan lengkap, menggunakan isyarat komunikasi bukan lisan, menyuntikkan pengajaran ke dalam pengajaran dan menerangkan dengan analogi dan perbandingan.

Matlamat utama Pendidikan Islam adalah untuk menyebarkan ajaran al-Quran sebagai sumber utama ilmu dan mencipta pengalaman berdasarkan asas-asas Islam seperti yang terkandung dalam al-Quran dan al-Sunnah yang tidak boleh diubah. Ia juga memberi pengamalan dalam bentuk maklumat dan kebolehan. Maka, dengan pemahaman bahawa pengamalan ini tertakluk kepada perubahan apabila masyarakat berkembang, mewujudkan kefahaman bahawa ilmu tidak lengkap tanpa asas akidah dan agama. Pendidikan Islam

memainkan peranan dalam mengembangkan komitmen terhadap nilai-nilai asas yang telah ditetapkan dan menerapkan rasa bertanggungjawab terhadap perintah Allah SWT sehingga manusia dapat menunjukkan prestasi dan kejayaan.

Memberi dorongan dalam persaudaraan sejagat tanpa mengira perbezaan kaum dan asal usul adalah untuk mendekatkan manusia dengan pemahaman tentang hubungan, di mana manusia berdiri dengan pencipta-Nya. Pendidikan Islam mengajar manusia untuk berakhlak mulia melalui ketakwaan dan iman dalam kalangan manusia bagi melahirkan manusia yang beriman dan juga pengetahuan dalam perkembangan kerohanian.

Menurut perspektif Islam, pembangunan dan kemajuan sesebuah negara tidak hanya dinilai dari perkembangan fizikal atau jasmani, tetapi merangkumi serta melibatkan dari segi aspek unsur moran dan kerohanian yang dipandu oleh al-Quran dan al-Sunnah sejak dahulu lagi. Kecerdasan intelektual dan kemodenan teknologi maklumat sahaja bukan satu petunjuk yang benar-benar mengukur peradaban suatu bangsa (Nasarudin et al., 2018). Pendidikan yang berunsurkan akhlak berdasarkan mata pelajaran Pendidikan Islam memberi pembuktian yang berhasil untuk mengembangkan peradaban sesebuah negara. Bagi mengatasi krisis kerosakan akhlak yang telah mempengaruhi kebangkitan dan kejatuhan sesebuah negara, ianya perlu menekankan terhadap pendidikan akhlak supaya menjadi punca kaitan yang utama sebagai pelindung akan tentangan baru yang boleh membawa kepada keruntuhan akhlak.

Menurut Asmawati Suib (2017) menyatakan bahawa input mengenai pendidikan berdasarkan prinsip dan falsafah Islam telah mengesahkan kecemerlangan peradaban manusia secara amnya dan peradaban Islam khususnya. Pengetahuan dan pengamalan akhlak yang mulia memainkan peranan dalam mewujudkan keamanan dalam kehidupan manusia. Bagi ulama dahulu yang dikenali sebagai Ibn Khaldun telah menjelaskan bahawa sifat ketidakadilan mengenai pelaksanaan pemerintahan boleh menyebabkan kehancuran sesebuah negara. Jelas menunjukkan terhadap akhlak yang baik sangat diambil peduli dalam kehidupan setiap diri individu, masyarakat mahupun negara (Faridah & Tengku Sarina Aini, 2016). Kemusnahan dan kejatuhan sesebuah platform utama negara bukan disebabkan dari kemerosotan ekonomi tetapi ianya berpunca daripada keruntuhan akhlak individu, masyarakat dan pemimpinnya.

Secara semulajadi, manusia sentiasa memerlukan pandangan dan nasihat untuk menjalani dan menempuhi kehidupan yang sempurna dari segi fizikal atau mental. Sebagaimana yang diriwayatkan oleh Bukhari dan Muslim mengenai agama merupakan nasihat adalah berdasarkan firman Allah SWT:

وَدَكِّرْ فَإِنَّ الذِّكْرَى تَنْفَعُ الْمُؤْمِنِينَ

Maksudnya: *“Dan tetaplah memberi peringatan, kerana sesungguhnya peringatan itu bermanfaat bagi orang yang beriman”*.

(Surah al-Dhariyyat: 55)

Penyampaian dan penerimaan pengajaran mahupun nasihat ialah dapat membentuk, memantapkan keperibadian dan akidah yang mulia. Hal ini juga dapat menerangkan semua fakta dengan mengajar prinsip-prinsip Islam secara sah dan meyakinkan. Terdapat tiga elemen penting dalam nasihat yang dapat mempengaruhi seseorang iaitu jantung adalah pusat akal, emosi sebagai pengantara kepada penilaian dan fizikal berfungsi sebagai kerangka yang membentuk diri. Menurut Nur Mashitah et al. (2016) menyatakan bahawa dengan melalui cara memberi nasihat dapat membuka minda pelajar mengenai suatu perkara sama ada yang baik atau sebaliknya, kemudian dapat menerapkan keimanan, jati diri dan nilai akhlak yang lebih baik dan mulia.

Pendidikan Islam sebagai suatu proses atas dasar pengembangan potensi diri pelajar, ianya bertujuan untuk mewujudkan keimanan dan ketakutan manusia kepada Allah SWT, berketrampilan, mempunyai etika kerja yang tinggi, berakhlak mulia, berdikari dan bertanggungjawab terhadap diri, bangsa, dan negara serta agama. Sifat yang murni dalam Islam adalah menginginkan akhlak yang mulia. Hal ini disebabkan akhlak yang mulia boleh mendatangkan perasaan yang bahagia dalam diri mereka sendiri dan untuk masyarakat secara umum. Dengan kata lain, adab utama dan paling penting ialah menunjukkan perhatian seseorang bukan hanya untuk kepentingan diri sendiri, malah untuk orang lain jua (Arif, 2016).

Bagi mencapai keperibadian akhlak yang baik adalah memerlukan pendidikan yang betul kerana pendidikan merupakan satu kaedah pengembangan, penyebaran dan pengajaran kepada manusia dengan sebuah tujuan mencipta dan menjayakan matlamat tertinggi Islam. Tujuan-tujuan itu adalah untuk mencapai kebahagiaan di duniawi dan ukhrawi, kesempurnaan dari segi jiwa masyarakat, memperoleh penerimaan dari Allah SWT, rahmat, keamanan dan mendapat keredhaan yang dijanjikan oleh Tuhan bagi hamba-Nya yang beramal soleh dan keperibadian akhlak yang baik. Dalam pendidikan akhlak, penerapan nilai-nilai berasaskan Islam harus dilihat menjadi sesuatu yang isu penting dalam meningkatkan hasil usaha menanam Islam ideologi sebagai pandangan dunia. Akan tetapi dalam usaha mewujudkan nilai-nilai moral Islam memerlukan proses yang panjang, sehingga penanaman tidak hanya dari aspek formal tetapi telah dimasukkan dalam aspek praktikal.

METODOLOGI

Metodologi kajian adalah perkara utama bagi menjalankan sesebuah penyelidikan atau kajian. Dapatan hasil yang diperolehi juga bergantung kepada metodologi yang digunakan dalam sebuah kajian. Pengkaji telah menggunakan kajian kepustakaan untuk mendapatkan maklumat-maklumat berasaskan fakta, teori, isu-isu semasa, penyelesaian masalah dan sebagainya. Pengkaji mendapatkan sebahagian besar maklumat dan teori-teori adalah dalam bentuk dokumentasi terutamanya melibatkan dengan Pendidikan Islam dan akhlak dalam memantapkan keperibadian jati diri pelajar. Kaedah kajian kepustakaan merupakan suatu langkah-langkah yang asas untuk digunakan oleh pengkaji dalam mengumpul data-data, teori-teori, menyelidik dan mengakses fakta-fakta yang berkaitan dengan penulisan tajuk kertas konsep ini.

Kajian kepustakaan juga sangat penting untuk dilakukan. Hal ini disebabkan pengkaji perlu meneliti, memahami dan menyelidik secara terperinci perkara-perkara konsep kajian, mengetahui peranan nilai-nilai Pendidikan Islam dalam diri pelajar, menjelaskan pandangan ulama mengenai akhlak menurut perspektif Islam dan mengetahui faktor-faktor pengamalan Pendidikan Islam yang mempengaruhi akhlak pelajar. Maklumat dan data sekunder yang berbentuk buku, dokumen, jurnal, artikel, tesis, kajian lepas dan lain-lain telah digunakan. Ianya bertujuan untuk pelaksanaan sorotan kepustakaan dalam kajian ini. Walau bagaimanapun, kajian kepustakaan ini hanya memberi dan menghuraikan kajian-kajian lepas berdasarkan fakta, data serta pengisian maklumat dari segi teori sahaja.

Di samping itu, pengkaji merujuk kepada al-Quran dan al-Hadis untuk mendapatkan teks yang berkaitan dengan akhlak menurut perspektif Islam. Selaras dengan isu-isu yang dibincangkan berdasarkan Islam, rujukan al-Quran dan hadis adalah garis panduan asas dalam kertas konsep ini. Kertas konsep ini juga merujuk kepada kitab-kitab muktabar sama ada tafsir al-Quran dan al-Hadis untuk dijadikan sebagai panduan mutlak bagi umat Islam dalam semua perkara kehidupan di dunia dan akhirat.

PERBINCANGAN

Pendidikan adalah kaedah untuk mendapat ilmu kemahiran, pengetahuan dan memupuk serta menerapkan nilai-nilai murni dalam diri setiap individu. Ilmu mengenai Pendidikan Islam adalah pengetahuan yang mesti dipelajari dan dipraktikkan oleh umat Islam untuk mempertahankan ummah daripada menyimpang ajaran yang dikemukakan dalam Islam. Maka, dengan melalui pengetahuan Pendidikan Islam, seseorang dapat menilai, membentuk dan memantapkan keperibadian yang lebih baik. Merujuk kepada dasar kurikulum Pendidikan Islam di sekolah mahupun institut pengajian tinggi, ia melibatkan enam unsur yang merangkumi bahagian tilawah ayat suci al-Quran, ibadah, sirah, akidah, ulum syariah dan akhlak. Melalui pembelajaran dalam bab ini, pelajar diajar dengan sumber ilmu pengetahuan yang sesuai dengan tahap pemikiran mereka sehingga pelajar boleh menonjolkan tahap mengenai amalan mereka dan menghayati serta menilai pengetahuan Pendidikan Islam dengan lebih baik dari sebelumnya.

Pengajaran mengenai akhlak sangat penting dan memberi kesan mendalam bagi mengembangkan modal insan yang bersifat fizikal. Namun, masyarakat hari ini mulai menyedari betapa pentingnya modal identiti yang dapat mendatangkan kemajuan dan kegemilangan kepada peradaban tamadun ummah. Hal ini bermaksud bahawa organisasi Pendidikan Islam akan menguatkan identiti dan keperibadian orang Melayu Islam. Ianya juga adalah rancangan yang utama bagi kebanyakan negara-negara Islam termasuk Malaysia. Oleh itu, ianya diakui dan dijelaskan bahawa bidang Pendidikan Islam adalah wahana yang penting untuk mencekam dan merealisasikan. Hal ini disebabkan sistem pengajaran dan pembelajaran akhlak mampu melahirkan warganegara yang lengkap dan sistematik yang berpengetahuan serta dapat mengekalkan identiti mereka sebagai seorang pelajar Muslim Melayu. Identiti yang dilahirkan mesti mempunyai nilai-nilai murni, etika dan kerohanian yang kuat melau keberhasilan daripada penyatuan rohani, jasmani, intelektual dan emosi dalam Pendidikan Islam.

Bagi para pelajar yang beragama Islam, mereka dididik dan dilatih dengan menerapkan unsur nilai-nilai murni melalui mata pelajaran Pendidikan Islam. Tetapi daya usaha ini harus dibuat dengan yakin, tekun dan memerlukan sebuah komitmen yang agak tinggi dari pelbagai pihak menguruskannya. Maka, harapan yang dibina adalah salah satu usaha untuk memperkukuhkan jati diri yang sempurna adalah melalui sistem pengajaran akhlak yang melahirkan masyarakat yang adil, setia, berkualiti dan berjaya dalam kehidupan di dunia dan akhirat jua. Ianya bukan sahaja memberi manfaat kepada diri sendiri tetapi juga masyarakat dan negara.

Penerapan Nilai-nilai Pendidikan Islam dalam Diri Pelajar

Ilmu pengetahuan perlu diterapkan dalam diri setiap pelajar supaya mereka dapat menilai dan berfikir secara rasional sebelum bertindak melakukan sesuatu terhadap perkara yang baik atau sebaliknya. Oleh itu, terdapat beberapa ilmu pengetahuan yang perlu diterapkan dalam diri pelajar melalui Pendidikan Islam bagi membentuk sahsiah diri yang baik, iaitu tilawah al-Quran, akidah, ibadah, sirah dan akhlak Islam.

Tilawah al-Quran

Pengajaran dan pembelajaran tilawah al-Quran merujuk kepada dalam mata pelajaran Pendidikan Islam yang terbahagi kepada pelbagai cabang dan salah satunya adalah bidang

berkenaan. Ianya merupakan memainkan peranan kepada setiap pelajar Muslim mesti menguasai hafazan al-Quran mengikut tahap yang telah disediakan dan kemampuan individu.

Akidah

Akidah menurut Imam al-Ghazali adalah sangat penting untuk seseorang memahami dengan penuh keyakinan mengenai maksud dan pengisian kandungan kalimah syahadah yang menjadi kesaksiannya bahawa tidak ada Tuhan yang harus disembah melainkan Allah SWT dan Nabi Muhammad SAW adalah utusan Allah SWT. Maka, dengan kepercayaan itu dapat memberi dorongan untuk menyokong al-Sunnah sambil mengelakkan diri daripada terjebak dengan kelompok bidaah. Melalui taqwa dan iman, manusia dapat menimbulkan perasaan yakin akan kewujudan zat, alam dan semua perbuatan Allah SWT dan kepercayaan akan kebenaran Nabi Muhammad SAW.

Ibadah

Bagi aspek ibadah pula, ianya penting untuk diamalkan dan dipelajari oleh setiap orang Islam. Pendedahan dan keperluan pendidikan sirah perlu dipupuk sejak awal lagi. Dalam bab ibadah ini, termasuk menunaikan solat, puasa, membaca al-Quran, berdoa, wirid dan zikir.

Sirah

Sirah ialah antara pengisian penting dalam Pendidikan Islam. Ianya terdapat kisah-kisah Nabi Muhammad SAW dan para sahabat. Pengajian sirah bukan hanya untuk mengetahui dan mempelajari kisah-kisah yang terjadi kejadiannya pada zaman Nabi Muhammad SAW, tetapi melalui sirah ini juga dapat dijadikan panduan hidup yang lebih sempurna bagi umat Islam hari ini, terutamanya daripada faktor sosial. Berdasarkan kajian yang dibuat oleh Mohd Nazri (2018), terdapat pelbagai fungsi bahagian sirah dalam kategori sosial, antaranya ialah berperanan untuk membangun iman, menggambarkan budaya Islam, sistem sosial dalam Islam dan mengajar mengenai ekonomi dalam Islam. Oleh itu, melalui pengajian sirah ini, manusia dapat menerapkan hubungan sosial pada masa kini berdasarkan kaedah yang betul.

Akhlak Islamiyyah

Seterusnya, akhlak Islamiyyah merupakan pendidikan akhlak yang terdapat di seluruh pusat pengajian sekolah termasuk sekolah rendah, menengah dan institut pengajian tinggi. Ianya berfungsi untuk mendidik dan menolong para pelajar untuk menilai dan membentuk keperibadian dan menjadi insan yang berakhlak mulia di mata semua orang. Hal ini disebabkan mereka adalah aset negara yang paling penting pada masa akan datang. Oleh itu, kepentingan pendidikan akhlak dalam kalangan pelajar pada masa kini adalah penting agar mereka dapat mempersembahkan keperibadian akhlak dan teladan yang lebih baik kepada kehadiran generasi akan datang. Hal ini disokong oleh kajian dari Safar et al. (2014) berpendapat bahawa terdapat beberapa fungsi dan peranan pendidikan akhlak kepada manusia. Antaranya ialah bagi membentuk potensi semangat dan daya kepekaan seseorang ke arah berbuat baik terhadap semua makhluk Tuhan, berusaha tidak terjebak dan menghindari semua daripada perbuatan yang dilarang oleh Tuhan dan dapat mencegah anggota masyarakat lain daripada melakukan kejahatan.

Akhlak Menurut Perspektif Islam

Pertumbuhan akidah atau kerohanian amat ditekankan dalam pendekatan Islam terhadap pendidikan akhlak. Hal ini adalah kerana akidah adalah asas ajaran agama Islam. Kepentingan akidah dalam Islam mungkin terdapat dalam nas-nas al-Quran dan hadis iaitu ramai orang kenal pasti dengan pembentukan akhlak. Istilah akhlak berasal dari perkataan Arab *'khuluq'* yang bermaksud budi pekerti atau kelakuan, tabiat, kepercayaan, kepercayaan atau agama. Akhlak menurut definisi ini ialah watak, tabiat, maruah atau agama yang mencerminkan imej atau penampilan dalaman seseorang. Akhlak kadangkala disebut sebagai perangai atau tabiat kerana ia merupakan sifat yang diwarisi sejak lahir. Tambahan pula, konsep al-Ghazali tentang akhlak adalah sebagai cermin keadaan dalaman yang mantap, malah daripadanya timbul tingkah laku yang mudah diserap dan tidak memerlukan pengulangan.

Menurut Imam al-Maududi, beliau menunjukkan bahawa seseorang itu mempunyai akhlak sejak lahir. Akhlak terbahagi kepada dua kategori iaitu akhlak yang mulia atau terpuji (*mahmudah*) dan akhlak yang tidak baik (*mazmumah*). Sebagaimana sabda Nabi Muhammad SAW yang bermaksud:

Maksudnya: *“Yang paling aku kasihan daripada kalangan kamu dan yang paling dekat kedudukannya denganku pada hari kiamat ialah yang paling mulia akhlaknya.”*

(Riwayat al-Tirmizi)

Akhlak, menurut Imam al-Ghazali bukanlah hak kelahiran, kerana seseorang itu mungkin baik tetapi tidak menyumbang atas sebab kewangan atau lain-lain. Di sisi lain, boleh dibayangkan bahawa seseorang yang memberi dalam wang akan menunjukkan mereka menyumbang supaya mereka dihargai. Tambahan pula, beliau percaya akhlak adalah tabiat peribadi yang membentuk corak tindakan seseorang dalam kehidupannya, bukannya pengetahuan atau pemahaman tentang baik dan salah. Menurut Imam al-Ghazali bahawa bersikap cerdik, menjauhi segala yang salah, berani (menundukkan kuasa hawa nafsu) dan adil adalah antara nilai yang mulia. Faktor pendorong terciptanya tamadun dan kejayaan yang diredhai Allah SWT ialah masyarakat dan negara yang mempunyai prinsip yang betul.

Akhlak mulia atau akhlak yang diredhai Allah SWT dapat dibangunkan melalui mendekatkan diri kepada Allah SWT, iaitu menunaikan segala amanat-Nya dan meninggalkan segala larangan-Nya, mengikuti ajaran sunnah Rasulullah SAW sebagaimana firman Allah SWT:

كُنْتُمْ خَيْرَ أُمَّةٍ أُخْرِجَتْ لِلنَّاسِ تَأْمُرُونَ بِالْمَعْرُوفِ وَتَنْهَوْنَ عَنِ الْمُنْكَرِ وَتُؤْمِنُونَ بِاللَّهِ

Maksudnya: *“Kamu adalah umat yang terbaik untuk manusia, menuju kepada yang makruf dan mencegah yang mungkar dan beriman kepada Allah”*.

(Surah al-Imran, 3: 110)

Dalam persekitaran global yang kompetitif hari ini adalah dianggap bahawa cita-cita untuk meningkatkan tamadun ummah dan menjana modal insan bertaraf dunia mungkin dapat direalisasikan melalui strategi Islam yang komprehensif dan praktikal. Sebagaimana yang dijanjikan oleh Allah SWT dalam firman-Nya:

وَلَوْ أَنَّ أَهْلَ الْقُرَىٰ ءَامَنُوا وَأَتَّقَوْا لَفَتَحْنَا عَلَيْهِم بَرَكَاتٍ مِّنَ السَّمَاءِ وَالْأَرْضِ

Maksudnya: *“Jikalau sekiranya penduduk suatu negeri itu beriman dan bertaqwa, pastilah Kami akan melimpahkan kepada mereka berkah dari langit dan bumi”*.

(Surah al-A'raf: 96).

Justeru itu, ia adalah perlu untuk meningkatkan dan memastikan keberkesanan amalan dan penghayatan moral yang tinggi dan kekuatan rohani dalam kalangan belia, khususnya pelajar. Akhir sekali, jika kita ingin mencapai objektif negara yang sedang diusahakan sekarang ini, pendidikan yang berteraskan tauhid dan falsafah serta prinsip-prinsip Islam perlu diperkasakan. Pendidikan akhlak yang berlandaskan perspektif Islam yang lengkap juga perlu dititikberatkan bagi mengelakkan "*litani of alarm*" yang digambarkan oleh James Arthur (2003) dalam kalangan rakyat Malaysia.

Faktor-faktor Pengamalan Pendidikan Islam yang Mempengaruhi Pemantapan Keperibadian Akhlak Pelajar

Akhlak dalam diri pelajar mencerminkan latar belakang perihal disiplin diri yang lahir daripada beberapa faktor yang memberi impak dalam merealisasikan dan melahirkan generasi baru yang berguna kepada agama, bangsa dan negara kelak. Antara faktor-faktornya ialah daripada ibu bapa, guru, rakan-rakan dan media massa. Tetapi, masih terdapat faktor-faktor lain yang mempengaruhi pelajar dalam membentuk akhlak dalam diri mereka.

Faktor ibu bapa

Faktor ibu bapa adalah aspek terpenting untuk pertumbuhan anak-anak sejak dari kecil hingga ke peringkat dewasa atau matang. Hal ini merujuk sehingga mereka mampu berdikari, hidup sendiri dan dapat membezakan yang mana baik dan buruk. Kaedah pemberian dan penerimaan pendidikan dari kedua ibu bapa adalah pendidikan yang penting selain daripada guru. Oleh itu, peranan sebagai ibu bapa adalah pengaruh yang erat dalam pemikiran dan perkembangan minda anak-anak, terutamanya bagi memberi proses pendidikan awal mengenai ajaran Islam. Hal ini disebabkan jika semua anak-anak menghayati dan meneliti terhadap setiap ajaran mengenai Islam, ia juga dapat menghindarkan diri daripada terjebak dalam perkara yang tidak sihat yang boleh mengakibatkan kerosakan akidah.

Di samping itu, rumah mahupun istana kediaman untuk berteduh merupakan salah satu madrasah yang pertama untuk kanak-kanak sebelum dihantar ke sekolah dan terus dididik oleh guru. Selain itu, ibu bapa juga menjadi teladan kepada anak-anak. Sekiranya contoh yang ditunjukkan adalah baik, maka muncul keberhasilannya juga bagus dan sebaliknya. Menurut Rohana Tan et al. (2016) mendapati bahawa pengaruh ibu bapa adalah kaitan besar dengan mempunyai hubungkait yang rapat dengan tingkah laku remaja yang dapat mempengaruhi tindakan pemikiran anak-anak, pencapaian akademik, akhlak anak-anak dan dapat mempengaruhi penghayatan moral kanak-kanak. Menurutnya, masalah yang sering terjadi dalam kalangan remaja kini adalah kerana mempunyai sosial latar belakang dari keluarga yang bermasalah. Hal ini menjelaskan bahawa peranan ibu bapa adalah agen terbesar dalam mempengaruhi anak-anak menjadi lebih baik. Oleh itu, ibu bapa perlu memberi sokongan kepada anak-anak untuk menghayati dan mempraktikkan setiap pengetahuan, terutamanya pengetahuan Pendidikan Islam ke dalam diri mereka di mana-mana jua.

Faktor guru

Faktor guru juga memainkan peranan penting kerana guru merupakan manusia yang mempunyai pengaruh untuk membentuk manusia menjadi insan yang berguna di mata dunia kelak. Hal ini disebabkan gelaran seorang guru atau pendidik adalah perantaraan untuk kanak-kanak memperoleh ilmu, termasuk aplikasi dalam pengetahuan, penghayatan dan pengamalan Pendidikan Islam. Sebilangan besar kajian terdahulu menghuraikan isu-isu kelemahan penghayatan mengenai Pendidikan Islam dan pengamalan akhlak pelajar. Sejajar dengan nilai-

nilai murni yang perlu ditingkatkan melalui mata pelajaran dan kurikulum Pendidikan Islam, peranan guru sebagai pendidik ilmu dan membentuk akhlak pelajar wajar ditingkatkan.

Peranan dan tugas seorang guru Pendidikan Islam sememangnya merupakan tanggungjawab yang sangat besar dan berat untuk mendekati pelajar dengan ilmu agama yang sah dan sebenar. Menjadi guru dalam menyampaikan dalam berbentuk Pendidikan Islam adalah ejen utama untuk melaksanakan semua sudut rancangan yang diubah oleh penggubal dalam sektor kurikulum pendidikan. Oleh yang demikian, guru Pendidikan Islam sering dikenali salah seorang *murrabi*, *mursyid*, *mu'allim*, *mudarris* dan *mu'addib* (Habibah, 2017). Oleh itu, ianya telah menjadi hak istimewa kepada guru Pendidikan Islam bagi mencapai tahap minimum guru yang ulung sesuai dengan persamaan ciri-ciri seorang Muslim yang baik dalam memikul sifat bertanggungjawab yang berat bagi menyampaikan ilmu pengetahuan kepada semua insan terutamanya yang bergelar seorang pelajar dan termasuk juga masyarakat sekeliling. Terdapat beberapa sudut penting yang perlu diutamakan apabila menjadi seorang guru Pendidikan Islam yang bertanggungjawab untuk mendidik dan membentuk sahsiah pelajar. Antaranya ialah seorang guru Pendidikan Islam mesti berkelakuan baik terhadap semua tingkah laku baik yang telah ditetapkan oleh undang-undang Islam, keperibadian dan tabiat terpuji yang diredhai Allah SWT.

Bagi meneliti tentang pemahaman dan minat pelajar dalam sewaktu proses pembelajaran diadakan, para guru mesti mahir menggunakan teknik pengajaran yang tepat, betul dan mudah difahami. Terdapat pelbagai mengenai kajian sebelumnya kebanyakannya mempersoal mengenai ketidaksediaan atau kelemahan guru dalam mengajar dan menyampaikan pelajaran adalah penyebab pengurangan terhadap penghargaan pelajar dalam mata pelajaran Pendidikan Islam. Menurut Sofiah Mohamed et al. (2016) dalam kajiannya menyatakan bahawa teori-teori akhlak seorang guru menurut ulama unggul seperti imam al-Ghazali yang memfokuskan kepada enam aspek akhlak, seperti seorang pendidik haruslah mempunyai perasaan simpati dan cinta. Perasaan sedemikian merujuk kepada menyayangi pelajar seperti anak-anak mereka sendiri, sering menasihati, ikhlas dalam mendidik, menegur kebijaksanaan sepenuhnya, mempraktikkan pengetahuan dan memberi pengajaran mengikut tahap kemampuan intelek pelajar Hal ini kerana apabila seorang guru berada hampir dengan pelajar, maka hal itu boleh mempengaruhi daya tahap pemahaman dan penghayatan kepada mereka terhadap sesuatu mata pelajaran, terutamanya untuk mempelajari mata pelajaran Pendidikan Islam.

Faktor rakan sebaya

Faktor rakan sebaya merupakan elemen luar dari rumah. Insan yang bergelar rakan adalah pengaruh yang besar bagi anak-anak masa kini. Justeru itu, dalam memilih rakan yang baik budi pekerti adalah sangat penting. Hal ini disebabkan ianya menggambarkan kelakuan anak-anak untuk menjadi orang yang berguna kelak. Timbul masalah sosial yang selalu terjadi kerana berpunca daripada pengaruh rakan sebaya yang semakin kuat selain penglibatan latar belakang dari keluarga yang telah mempunyai masalah, terutama bagi pelajar yang membesar pada usia remaja yang hanya mahu mengetahui identiti peribadi mereka. Faktor pengaruh dari rakan sebaya adalah kuasa pengaruh yang dapat membuat seseorang terlibat dengan perkara yang baik atau sebaliknya. Hal ini disokong oleh kajian sebelumnya iaitu dari Abd. Halim (2017) yang menyatakan bahawa pergaulan campur antara remaja dengan rakan sebaya sama ada lelaki atau perempuan boleh membawa kepada nilai negatif yang akan mempengaruhi remaja dan terjebak untuk berkelakuan yang tidak baik.

Faktor media massa

Faktor media massa adalah satu aliran proses perantaraan untuk menyalurkan atau menyampaikan semua pengisian maklumat dan isu-isu semasa kepada orang ramai. Namun, dengan kehadiran pelbagai kemudahan teknologi media massa seperti komputer riba, telefon bimbit mudah alih bukan sahaja menjadikannya lebih mudah untuk mendapatkan perincian berita dan maklumat terkini. Tetapi ia dapat menimbulkan provokasi bagi pelajar, terutamanya dari segi praktik menghayati Islam dan pengisiannya. Hal ini disokong oleh Nur Hanani Husin (2017) berpendapat bahawa faktor dan unsur-unsur dari media massa merupakan hal yang menimbulkan impak negatif kepada pemikiran, pengetahuan, penghayatan dan pengamalan akhlak pelajar itu sendiri. Dalam arus kemodenan ini, penggunaan media massa dan kecanggihan peralatan elektronik menjadi suatu perantaraan alat terpenting untuk mendapatkan pelbagai sumber maklumat yang banyak dan terpencil di sudut dunia.

Sebagai rumusnya, Pendidikan Islam di Malaysia memainkan peranan penting dalam melahirkan keperibadian generasi muda yang bersepadu untuk memenuhi keperluan negara pada abad ke-21. Oleh itu, ia berpendapat bahawa terdapat keperluan untuk kurikulum sekolah bersepadu yang dapat mengembangkan semua potensi pelajar. Dalam dalam situasi ini, guru atau pendidik serta ibu bapa mesti menunjukkan contoh dan model untuk diikuti oleh kanak-kanak dari segi konsep akhlak, moral dan etika yang sesuai. Tanpa persoalan, pendakwah yang paling berjaya ialah ibu bapa dan guru. Malah, guru bukan sahaja harus membincangkan kisah-kisah doktrin dalam Islam, tetapi juga contoh-contoh kehidupan di dunia sebenar iaitu model kehidupan dalam kehidupan yang nyata. Guru bukan sahaja perlu menyampaikan fakta dan pengetahuan kepada pelajar, tetapi juga meningkatkan pemahaman mereka tentang manusia dan teknologi supaya mereka dapat menangani cabaran dengan berkesan dan mengharungi zaman globalisasi.

KESIMPULAN

Kesimpulannya, melalui konteks arus kemodenan dunia global yang kompetitif mengenai pendidikan menunjukkan bahawa kepentingan pengajaran dan pembelajaran akhlak dalam sistem pendidikan negara adalah satu kaedah pendekatan kepada pelajar. Ilmu Pendidikan Islam yang secara khususnya berfungsi untuk membentuk dan mendidik identiti akhlak serta akidah orang Melayu Islam. Hal ini disebabkan mata pelajaran Pendidikan Islam sering mengalami pemindaan demi keberkesanan dan peningkatan dalam sistem pengajaran akhlak. Hal ini terbukti jelas yang menunjukkan bahawa ajaran akhlak dan etika yang dilaksanakan mesti dihubungkan dengan nilai-nilai Islam khususnya dan nilai-nilai agama secara umum. Tanpa adanya ikatan ini, manusia yang akan dilahirkan tentunya tidak akan memiliki kekuatan dari segi rohani dan mudah terpengaruh dengan arus kemodenan yang bertentangan dengan prinsip ajaran agama Islam.

Di samping itu, pengajaran akhlak Islam perlu mempunyai inisiatif dan langkah-langkah yang perlu diambil agar lebih komprehensif untuk mengukur dari segi aspek ilmu pengetahuan pelajar mengenai akhlak. Keadaan yang kondusif untuk pembentukan dan pemantapan keperibadian akhlak yang lebih baik perlu diwujudkan di persekitaran sekolah, keluarga dan masyarakat. Kewujudan keadaan yang saling mempertahankan ini dapat mempengaruhi pelajar yang berakhlak mulia dan beretika dapat dilahirkan dari semasa ke semasa atas didikan yang betul. Kejayaan seseorang pelajar dalam membentuk dan memantapkan keperibadian akhlak yang baik bergantung kepada tahap pencapaian dalam bidang akademik dan kecemerlangan akhlak serta etika. Tetapi, tumpuan harus bukan hanya pada akademik sahaja, malah ia juga kepada aspek akhlak dan etika. Akhirnya, bagi mencapai

hasrat dan impian mulia untuk memantapkan keperibadian akhlak dalam kalangan pelajar memerlukan komitmen dan usaha dari pelbagai pihak sangat diperlukan. Ianya menjadi satu proses dalam melahirkan generasi yang berakhlak mulia kepada agama, bangsa dan negara.

RUJUKAN

Al-Quran al-Karim.

- Ab. Halim T., Khadijah A. R. & Shahrin A. (2010). Kaedah Pengajaran Pendidikan Islam: Konvensional dan Inovasi. Bangi: Penerbit Universiti Kebangsaan Malaysia.
- Abd. Halim & Ruzieha. (2017). Penghayatan Agama Islam Sebagai Mediator dalam Hubungan antara Persekitaran Sosial dengan Salah Laku Seksual Pelajar Islam. Universiti Teknologi Malaysia, 34.
- Arif Billah. (2016). Pendidikan Karakter untuk Anak Usia Dini dalam Perspektif Islam dan Implementasinya dalam Materi Sains. *At-Ta'dib Tarbiyah*, 1(2): 243-272. doi: <https://doi.org/10.18326/attarbiyah.v1i2>
- Asmawati Suhid. (2017). Pengajaran Adab dan Akhlak Islam dalam Membangunkan Modal Insan. *Jurnal Pengajian Umum Asia Tenggara*, 8: 167-178.
- Asmawati Suhid. (2017). Pemantapan Komponen Akhlak dalam Pendidikan Islam Bagi Menangani Era Globalisasi. Selangor: Universiti Putra Malaysia. *Jurnal Kemanusiaan* 3(2): 95-104.
- Buerah T., Shanah N. & Hamimah A. N. (2015). Delinkuen Pelajar dan Cadangan Penyelesaiannya Menerusi Model Pembangunan Sahsiah Remaja/Pelajar Muslim Bersepadu. *Jurnal Hadhari* 7(2): 11-30.
- Faridah C. H. & Tengku Sarina A. T. K. (2016). Pendekatan Psikologi dalam Pendidikan Akhlak Muslim sebagai Pemangkin Pembangunan Insan dan Tamadun. *Jurnal Pengajian Melayu*, 17: 290-306.
- Fathiyah M. F. (2010). Penerapan Elemen Falsafah Pendidikan Islam dalam Pengajaran Pendidikan Islam di Sekolah Menengah. Lembah Klang. *Tesis Doktor Falsafah*. Selangor: Universiti Putra Malaysia.
- Habibah @ A. R. (2017). Pembangunan Model Profesionalisme Guru Pendidikan Islam Berasaskan Riadhah Ruhyyah. *Tesis Doktor Falsafah*. Kuala Lumpur: Universiti Malaya.
- James A. (2003). *Education with Character: The Moral Economy of Schooling*. London: Routledge.
- Kementerian Pendidikan Malaysia. (2015). Dokumen Standard Kurikulum dan Pentaksiran Pendidikan Islam.
- Mohd N. A. & Nurul Salsabila A. B. (2018). Sirah dalam Menegakkan Perubahan Sosial Mengikut Pandangan Syeikh Said Ramadhan Al-Buti. *Al-Banjari*, 266-268.
- Nasarudin Desa @ M., Tengku Intan Z. T. P. & Sabri M. (2018). Menangani Keruntuhan Akhlak Masa Kini Menurut Islam. *Jurnal al-Turath*, 3(1): 55-63. Bangi: Universiti Kebangsaan Malaysia. <http://spaj.ukm.my/jalturath>
- Nasarudin Desa @ M., Tengku Intan Z. T. P. & Sabri M. (2018). Menangani Keruntuhan Akhlak Masa Kini Menurut Islam. *Al-Turath Journal of Al-Quran and Al-Sunnah*, 3(1): 55-63.
<http://spaj.ukm.my/jalturath/index.php/jalturath/article/view/62/63>
- Noornajihan J., Muhamad, Nurul Asiah F. M., Ahmad Kamil J., Mohd Faizal K., Norhaziah H. & Norzulaili M. G. (2017). Prophetic Communication Styles in Teaching. *Advanced Science Letters* 23(5): 4761-4764. doi: <https://doi.org/10.1166/asl.2017.8888>
- Nur Hanani H. (2017). Cabaran Pendidikan Islam di Era Media Sosial. *Malaysian Online Journal of Education*, 34.

- Nur Mashitah M. K., Mohd Isa & Mohd Aderi C. N. (2016). Pendekatan Nasihat Melalui al-Quran dan Hadith dalam Pengajaran Pendidikan Islam. *Wacana Pendidikan Islam Peringkat Kebangsaan Siri ke-11*. Bangi: Universiti Kebangsaan Malaysia, 1215-1224.
- Rohana Tan, Norhasni Z. A., Azimi H. & Fathiyah M. F. (2016). Hubungan Pendidikan Keagamaan oleh Ibu Bapa dan Pertautan Rakan Sebaya dengan Akhlak Belia di Institusi Pengajian Awam yang Terpilih di Selangor. *Malaysian Journal of Youth Studies*, 95.
- Safar, Ajmain @ Jimaain; Muhammad, Ahmad Marzuki; W. Embong & W. Hassan. (2014). Pendidikan Akhlak dalam Sistem Pendidikan di Malaysia Sebagai Asas Kecemerlangan Pencapaian Sains dan Teknologi. In: *Seminar Antarabangsa Education, Law, Civilization, Sains & Teknologi dalam Konsep dan Aplikasi (Elcist 2014)*, 26. Johor: Skudai.
- Sofiah M., Kamarul A. J. & Muhammad A. Z. (2016). Akhlak Guru dalam Pengajaran dan Pembelajaran Pendidikan Islam. *Akademika*, 32-33. doi: <https://10.17576/akad-2016-8602-02>

Isu dan Cabaran Pengajaran Iqra' Guru Pendidikan Islam Pendidikan Khas Masalah Pendengaran

Hifzan Mat Hussin

Fakulti Pengajian Bahasa dan Pembangunan Insan, Universiti Malaysia Kelantan, Malaysia
hifzanmathussin83@gmail.com

Kamarulzaman Abdul Ghani

Fakulti Pengajian Bahasa dan Pembangunan Insan, Universiti Malaysia Kelantan, Malaysia
kamarulzaman@umk.edu.my

ABSTRACT

Islamic education is a core subject that must be studied by all Muslim students including students with special needs such as hearing impaired who belong to the mukallaf group. The j-QAF Special Education program was implemented in 2007 with the aim of strengthening Islamic Education subjects. However, the j-QAF e-reporting data every year shows that the level of reading iqra' among special education students has not shown a significant increase, even though the program has been implemented for more than 10 years. Therefore, this study aims to explore the issues and challenges of Special Islamic Education (GPIPK) teachers in teaching iqra' to special needs students with hearing problems in Kelantan. This study chose a qualitative research method in the form of case studies and purposive sampling involving seven participants as informants from three schools in Kelantan. Overall, the research findings have found two themes, namely the theme of internal challenges and external challenges. This study benefits the GPIPK, the administrators, the District Education Office, the State Education Department and also the Malaysian Ministry of Education in an effort to improve GPIPK teaching.

Keywords: *Islamic Education, Special Education Islamic Education Teacher, Hearing Problems, Issues and Challenges*

ABSTRAK

Pendidikan Islam merupakan mata pelajaran teras yang wajib dipelajari oleh semua murid Islam termasuk murid berkeperluan khas seperti bermasalah pendengaran yang tergolong dalam golongan mukallaf. Program j-QAF Pendidikan Khas telah dilaksanakan pada tahun 2007 bertujuan untuk memantapkan mata pelajaran Pendidikan Islam. Namun, data e-pelaporan j-QAF pada setiap tahun menunjukkan tahap bacaan iqra' dalam kalangan murid pendidikan khas tidak menunjukkan peningkatan yang ketara, walaupun program tersebut telah dilaksanakan lebih 10 tahun. Oleh itu, kajian ini bertujuan meneroka isu dan cabaran guru Pendidikan Islam Pendidikan Khas (GPIPK) dalam pengajaran iqra' murid berkeperluan khas masalah pendengaran di Kelantan. Kajian ini memilih kaedah kajian kualitatif secara kajian kes dan pensampelan secara bertujuan melibatkan tujuh orang peserta sebagai informan daripada tiga buah sekolah di Kelantan. Secara keseluruhan dapatan kajian telah menemui dua tema, iaitu tema cabaran dalaman dan cabaran luaran. Kajian ini memberi manfaat kepada GPIPK, pihak pentadbir, Pejabat Pendidikan Daerah, Jabatan Pendidikan Negeri dan juga Kementerian Pendidikan Malaysia dalam usaha menambah baik pengajaran GPIPK.

Kata kunci: *Pendidikan Islam, Guru Pendidikan Islam Pendidikan Khas, Masalah Pendengaran, Isu dan Cabaran*

PENDAHULUAN

Mata pelajaran Pendidikan Islam adalah salah satu mata pelajaran yang wajib dipelajari oleh semua murid yang beragama Islam tidak kira pada peringkat rendah atau menengah. Semua murid di Malaysia wajib mempelajarinya. Ini termasuklah golongan istimewa seperti pekak, bisu dan buta, kewajiban agar mempelajari al-Quran ke atas mereka juga sama seperti muslim normal yang lain (Karamah et al., 2019).

Al-Quran adalah salah satu cabang dalam mata pelajaran Pendidikan Agama Islam dan mata pelajaran ini wajib diajar walaupun di kelas pendidikan khas sama ada masalah pembelajaran, penglihatan dan juga pendengaran (Hamdi Ishak et al., 2012). Namun, sukatanya diubah mengikut kesesuaian dan ketidakupayaan murid (Siti Patonah et al., 2014). Program j-QAF dilaksanakan bertujuan membantu memperkasakan mata pelajaran Pendidikan Agama Islam.

Iqra' adalah kaedah yang digunakan dalam sistem pengajaran al-Quran di Malaysia. Seiring dengan pelaksanaan program j-QAF, kaedah iqra' diangkat melalui Modul Pengajaran dan Pembelajaran Iqra'. Kaedah iqra' ini juga dilaksanakan dalam pengajaran al-Quran di kelas Pendidikan khas samada di Sekolah Pendidikan Khas (SKPK), Program Pendidikan Khas Integrasi (PPKI) dan Program Pendidikan Inklusif (PPI) (Bahagian Pendidikan Khas, 2008).

Murid pendidikan khas masalah pendengaran mempelajari al-Quran melalui bahasa isyarat. Ada beberapa kaedah dalam pengajaran al-Quran murid pekak. Antaranya ialah kaedah Tahfiz Akhyar, kaedah Iqra', kaedah Fakeh, kaedah pengulangan, kaedah pertuturan Kiu dan yang terbaru adalah kaedah Bahasa Isyarat Arab (Muhammad Zaid & Rosadah, 2020; Ummu Karamah et al., 2019).

PERMASALAHAN KAJIAN

Kementerian Pendidikan Malaysia telah merancang dan menyediakan pelbagai kemudahan bagi murid berkeperluan khas di Malaysia seperti Program Pendidikan Khas Integrai (PPKI), Sekolah Kebangsaan Pendidikan Khas (SKPK), Program Pendidikan Inklusif (PPI) dan pelbagai kemudahan diberikan kepada murid berkeperluan khas untuk meningkatkan prestasi akademik mereka.

Namun, data e-pelaporan j-QAF Pendidikan Khas menunjukkan tahap penguasaan bacaan iqra' murid pendengaran yang sangat lemah dan tiada peningkatan (Hifzan et al., 2022). Walaupun program j-QAF Pendidikan Khas telah dilaksanakan lebih dari sepuluh tahun, namun sebahagian besar murid pendengaran masih berada pada bacaan buku iqra' satu dan ini memberi kesan kepada mereka apabila ke sekolah menengah (Rabiatuladawiyah & Mohd Nizam, 2019). Berikut adalah jadual 1 berkaitan analisis pencapaian al-Quran bagi murid pendidikan khas.

Jadual 1. Analisis al-Quran Murid Pendidikan Khas

KATEGORI	IQRA' 1	IQRA' 2	IQRA' 3	IQRA' 4	IQRA' 5	IQRA' 6	AL- QURAN	JUMLAH
Masalah Pendengaran	45	10	0	0	1	0	0	56
Masalah Pembelajaran	1576	588	258	95	45	19	25	2606
Masalah Penglihatan	4	2	2	1	3	2	3	17
Masalah Fizikal	18	4	2	2	0	0	1	27
Masalah Pertuturan	9	0	0	1	0	0	1	11
Masalah Pelbagai	43	5	3	0	1	0	0	52
Jumlah keseluruhan	1695	609	265	99	50	21	30	2769

Sumber: e-pelaporan j-QAF (2020)

Hal ini bertepatan dengan kajian yang telah dilakukan oleh (Nik Hassan et al., 2016) bahawa pencapaian akademik pelajar cacat pendengaran masih lemah, khususnya dalam mata pelajaran Pendidikan Islam. Penguasaan iqra' yang lemah ini berpunca dari beberapa faktor. Antaranya ialah faktor murid, ibu bapa, BBM, guru dan juga persekitaran. Namun banyak kajian lepas membuktikan bahawa faktor guru merupakan faktor terbesar dalam menyumbang kepada pencapaian akademik murid (Azmil Hashim et al., 2020; Hamdi Ishak et al., 2019; Mohd Fadzli & Mohd Sukki, 2012; Mohd Nahi, 2018).

Justeru, kajian ini bertujuan untuk mengkaji apakah isu dan cabaran yang wujud dalam pengajaran iqra' guru Pendidikan Islam dalam kalangan murid Pendidikan khas masalah pendengaran. Adakah isu dan cabaran tersebut memberi kesan terhadap pencapaian bacaan iqra' murid yang rendah ini. Tidak banyak kajian lepas yang dilakukan berkaitan isu dan cabaran dalam bidang ini.

OBJEKTIF KAJIAN

Objektif kajian ini adalah untuk:

- 1) Meneroka isu dan cabaran guru Pendidikan Islam dalam pengajaran iqra' murid berkeperluan khas pendengaran.

PERSOALAN KAJIAN

Persoalan kajian ini adalah:

- 1) Sejauhmanakah isu dan cabaran guru Pendidikan Islam dalam pengajaran iqra' murid berkeperluan khas pendengaran?

METODOLOGI KAJIAN

Reka bentuk kajian

Kajian ini menggunakan kaedah kualitatif secara kajian kes. Reka bentuk kualitatif terdiri dari lima jenis iaitu jenis etnografi, *grounded-theory*, fenomenologi, biografi dan kajian kes (Othman Lebar, 2018). Menurut Othman Lebar (2018), kajian kes boleh dilihat dari pelbagai segi. Antaranya dari segi proses melaksanakan analisis atau dari segi produk sebagaimana Merriam (2009) yang mendefinisikan kajian kes sebagai penghuraian mendalam dan analisa kepada suatu sistem yang terbatas. Yin dan Yin (2013) mendefinisikan kajian kes dari segi proses penyelidikan. Pemilihan kaedah kajian kes perlu sesuai dengan tujuan kajian yang ingin dikaji.

Kajian kes digunakan dalam kajian ini kerana melibatkan pengumpulan data secara sistematik dan mendalam mengenai proses pengajaran dan pembelajaran murid pendidikan khas masalah pendengaran dalam mata pelajaran Pendidikan Islam. Kajian kes adalah kajian yang difokuskan hanya kepada satu kes atau beberapa kes dalam bilangan kecil untuk menjawab persoalan kajian (Mohd Yusri, 2017).

Unit analisis

Pengkaji telah memilih pensampelan bertujuan seramai tujuh orang guru Pendidikan Khas Masalah Pendengaran (GPIPK) di Kelantan iaitu PPKI daerah Kota Bharu, PPKI di daerah Bachok dan sebuah SKPK di Pasir Mas. Guru-guru yang terpilih adalah dalam kalangan guru-guru yang mengajar berdasarkan jantina, kelayakan akademik, umur dan pengalaman mengajar. Pengkaji juga telah menentukan ciri-ciri tertentu untuk memilih peserta kajian, antaranya ialah guru yang telah lima tahun mengajar Pendidikan Islam di kelas pendidikan khas dan juga mudah dihubungi serta dapat memberi kerjasama dengan baik.

Pengumpulan dan analisis data

Data dalam kajian ini diperoleh melalui temubual semi struktur, pemerhatian ke atas dua orang peserta dan juga analisis dokumen Rancangan Pengajaran Harian (RPH) setiap GPIPK. Dapatan dari temubual, pemerhatian dan analisis dokumen telah dikumpul dan dikemas kini di dalam perisian ATLAS.ti versi 9. Seterusnya pengkaji menganalisis data-data tersebut melalui perisian tersebut dengan melibatkan proses mengkod, mengkategorikan dan menamakan tema yang sesuai bagi menjawab persoalan kajian. Berikut adalah rajah 1 berkaitan ciri demografi informan yang telah dihasilkan melalui perisian ATLAS.ti versi 9.

MALAYSIA
KELANTAN

Rajah 1. Ciri Demografi Informan

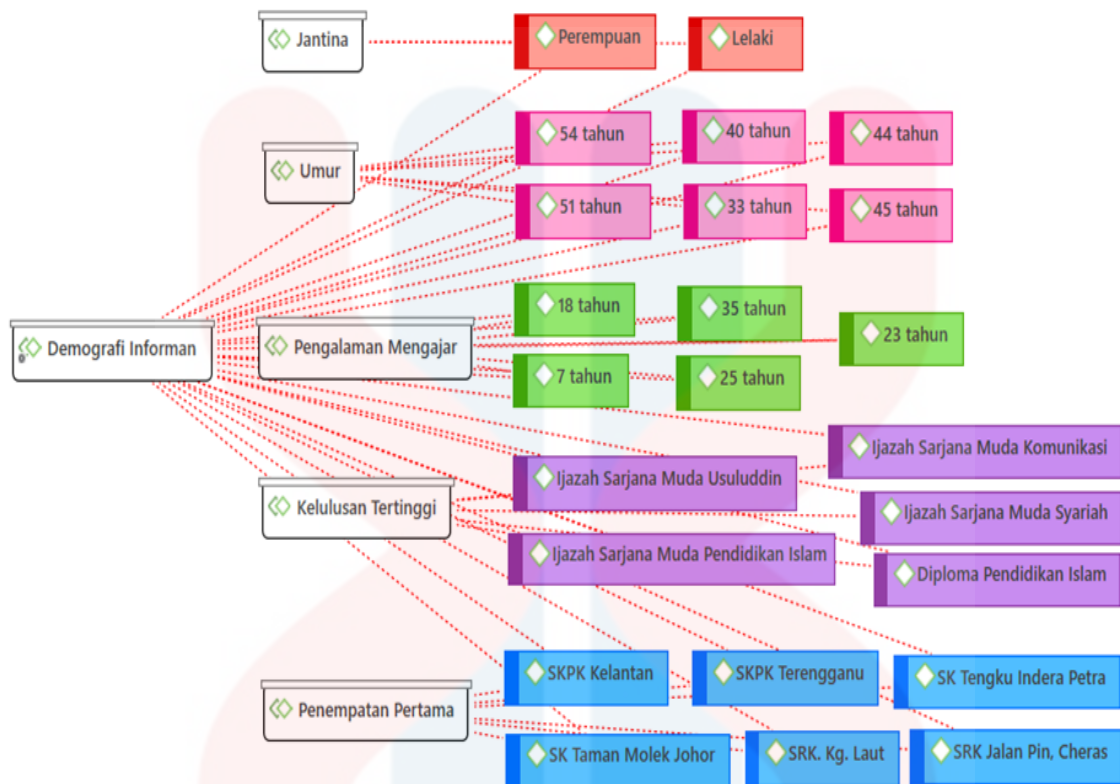

DAPATAN KAJIAN

Kajian ini telah menemui dua tema bagi menjawab persoalan kajian berkaitan isu dan cabaran GPIPK dalam pengajaran iqra' murid berkeperluan khas pendengaran. Tema tersebut adalah cabaran dalaman dan cabaran luaran. Tema cabaran luaran mempunyai empat kategori, iaitu masa pengajaran terhad, kurang latihan, kurang motivasi dan juga tiada kolaborasi tasmik. Manakala cabaran luaran lahir dari kategori kesedaran ibubapa yang rendah dan keupayaan murid yang terhad.

Tema pertama; Cabaran Dalaman

Tema ini lahir dari empat kategori dan kategori ini lahir dari sepuluh kod. Kod-kod tersebut adalah masa pengajaran yang terhad, hanya mahir huruf hijaiyyah tunggal, kaedah Fakeh sukar, kurang kursus/ latihan, cabaran setiausaha pelaporan j-QAF, tiada kepuasan mengajar, tidak konsisten tasmik, guru kurang kesedaran, cabaran tasmik dan juga kolaborasi. Kod-kod ini telah dikumpul dan diasingkan kepada empat kategori yang sesuai. Rajah 2 di bawah menunjukkan kesimpulan tema bagi cabaran dalaman yang telah dihasilkan oleh ATLAS.ti versi 9.

Rajah 2. Tema Cabaran Dalam

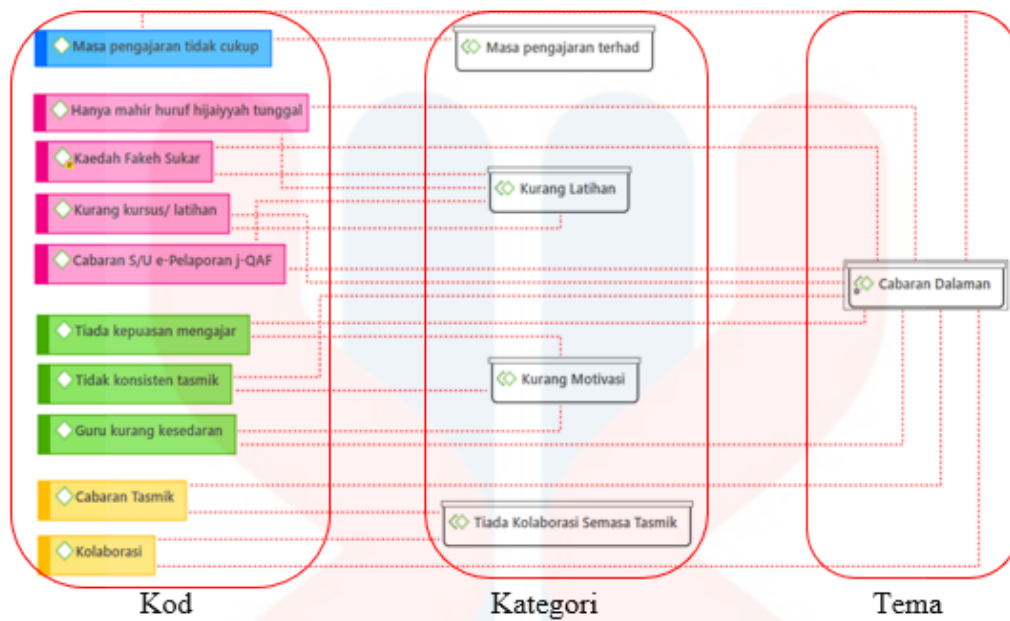

Rajah diagram Sankey dibawah menunjukkan tahap kekerapan berkaitan kod atau isu yang diutarakan oleh para peserta kajian. Daripada sepuluh kod atau isu serta cabaran yang diketengahkan, terdapat tiga kod yang menunjukkan tahap seriusnya isu tersebut. Kod tersebut adalah tidak konsisten tasmik, kaedah Fakeh sukar dan guru kurang kesedaran.

Rajah 3. Diagram Sankey Cabaran Dalam

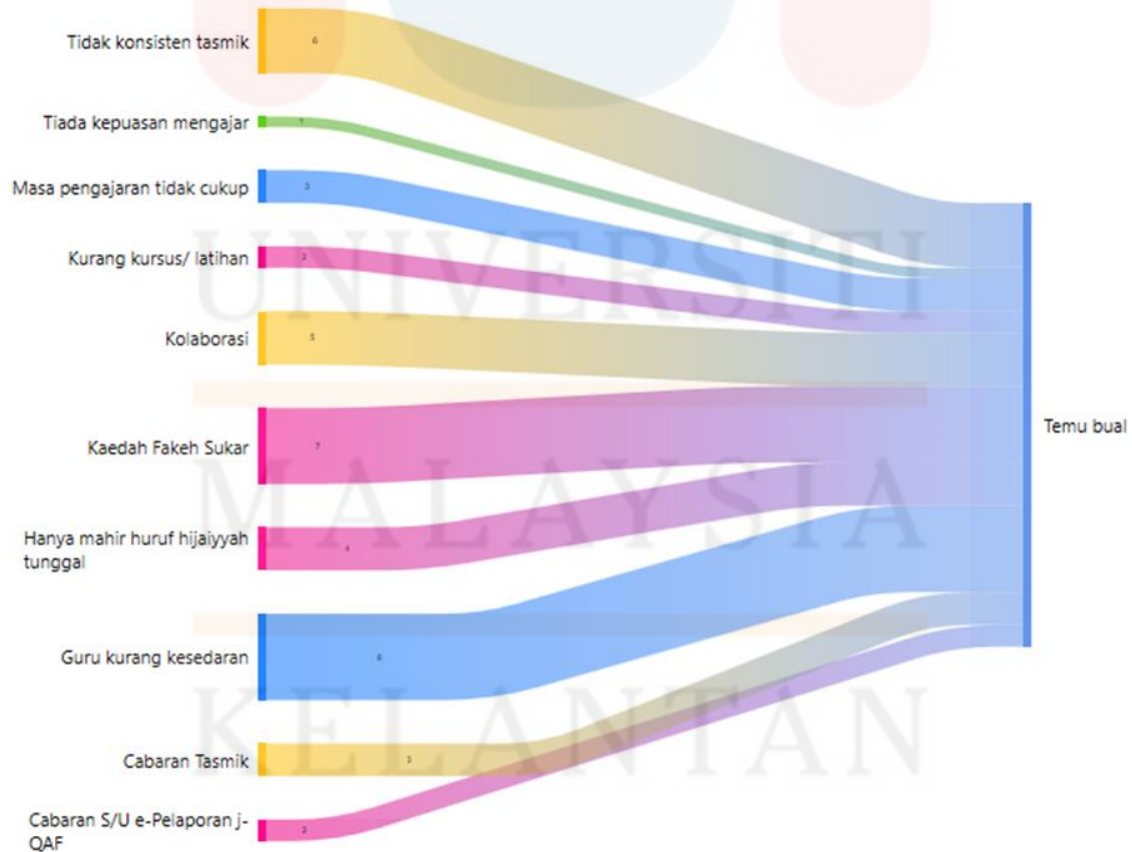

Tidak Konsisten Tasmik

Kod berkaitan tidak konsisten tasmik ini telah diutarakan oleh kebanyakan peserta kajian. Kebanyakan mereka mengatakan sesetengah guru Pendidikan Islam tidak melakukan tasmik sebagaimana yang sepatutnya dilakukan sebanyak sekali dalam seminggu. Iaitu 30 minit dalam waktu pdpc al-Quran. Namun, ramai yang hanya melakukan tasmik kadang-kadang sahaja. Lebih-lebih lagi sewaktu PdPR yang lalu, tasmik langsung tidak dilaksanakan. Berikut adalah rajah 4 berkaitan kata-kata informan kajian terhadap isu ini.

Rajah 4. Diagram Tidak Konsisten Tasmik

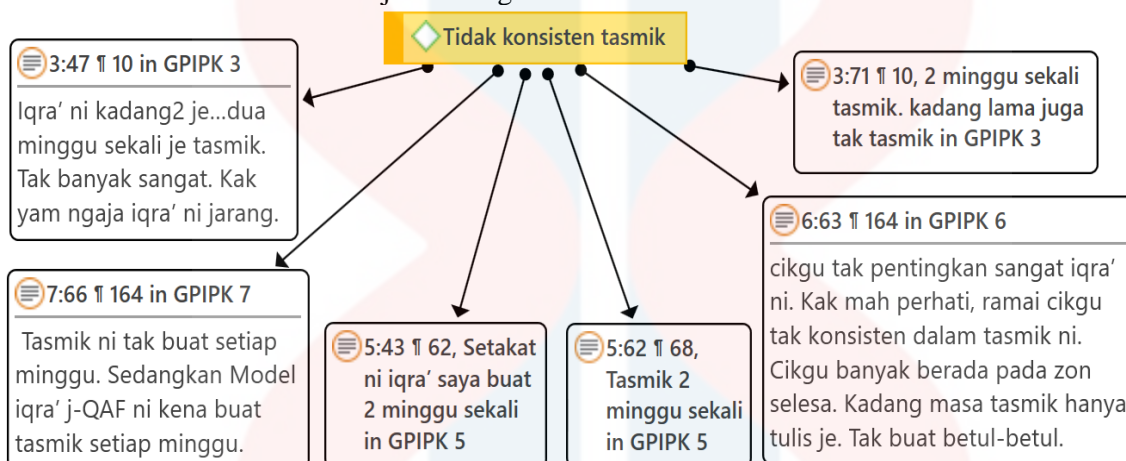

Kaedah Fakeh Sukar

Kod berkaitan kaedah Fakeh sukar ini telah diketengahkan oleh peserta kajian. Kebanyakan mereka mengatakan sesetengah guru Pendidikan Islam sukar untuk mengajar kaedah Fakeh, lebih-lebih lagi ayat yang panjang. Ini kerana kaedah ini melibatkan sistem penomboran berserta baris untuk membaca al-Quran. Berikut adalah kata-kata informan berkaitan isu ini.

Rajah 5. Diagram Kaedah Fakeh Sukar

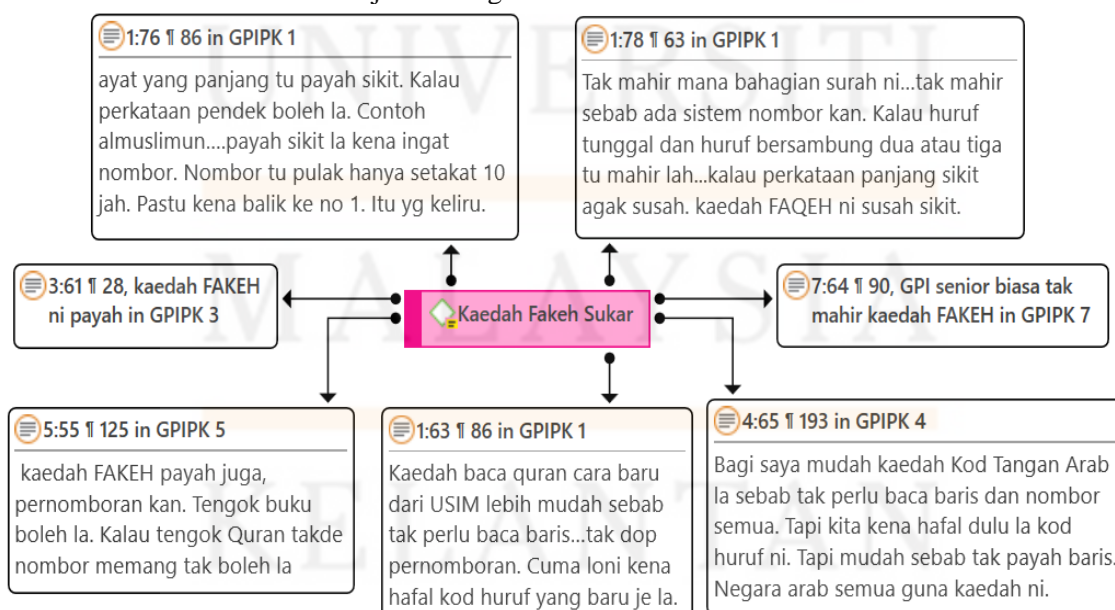

Guru Kurang Kesedaran

Seterusnya kod yang banyak dibicarakan adalah guru kurang kesedaran. Banyak cabaran dan isu berkaitan guru Pendidikan Islam yang boleh diklasifikasikan sebagai guru kurang kesedaran. Berikut adalah kata-kata informan berkaitan kod guru kurang kesedaran ini.

Rajah 6. Diagram Guru Kurang Kesedaran



Tema kedua; Cabaran Luaran

Tema ini lahir dari dua kategori dan kategori ini lahir dari empat kod. Kod-kod tersebut adalah ibu bapa tiada kesedaran, ibu bapa tidak tahu bahasa isyarat, murid lemah ingatan dan tahap pendengaran mempengaruhi kecerdikan. Kod-kod ini telah dikumpul dan diasingkan kepada dua kategori yang sesuai, iaitu kategori kesedaran ibu bapa yang rendah dan keupayaan murid yang terhad. Rajah 7 di bawah menunjukkan kesimpulan tema bagi cabaran luaran yang telah dihasilkan oleh ATLAS.ti versi 9.

Rajah 7. Tema Cabaran Luaran



Kesedaran ibu bapa yang rendah

Isu kesedaran ibu bapa yang rendah ini timbul dari kod ibu bapa tiada kesedaran dan ibu bapa tidak tahu bahasa isyarat. Ramai ibu bapa tidak tahu cara berkomunikasi dengan anak mereka. Melainkan ibu bapa yang juga OKU pekak. Namun mereka tidak pandai mengajar al-Quran kepada anak mereka. Kebanyakan guru mengatakan murid yang dapat membaca iqra' dengan baik biasanya ibu bapa yang cakna akan al-Quran anak-anak. Mereka mengajar anak-anak di rumah dan ada yang menghantar kepada guru al-Quran. Rajah 8 berikut merupakan kata-kata peserta kajian berkaitan isu kesedaran ibu bapa yang rendah.

Rajah 8. Kategori Kesedaran Ibu Bapa Yang Rendah

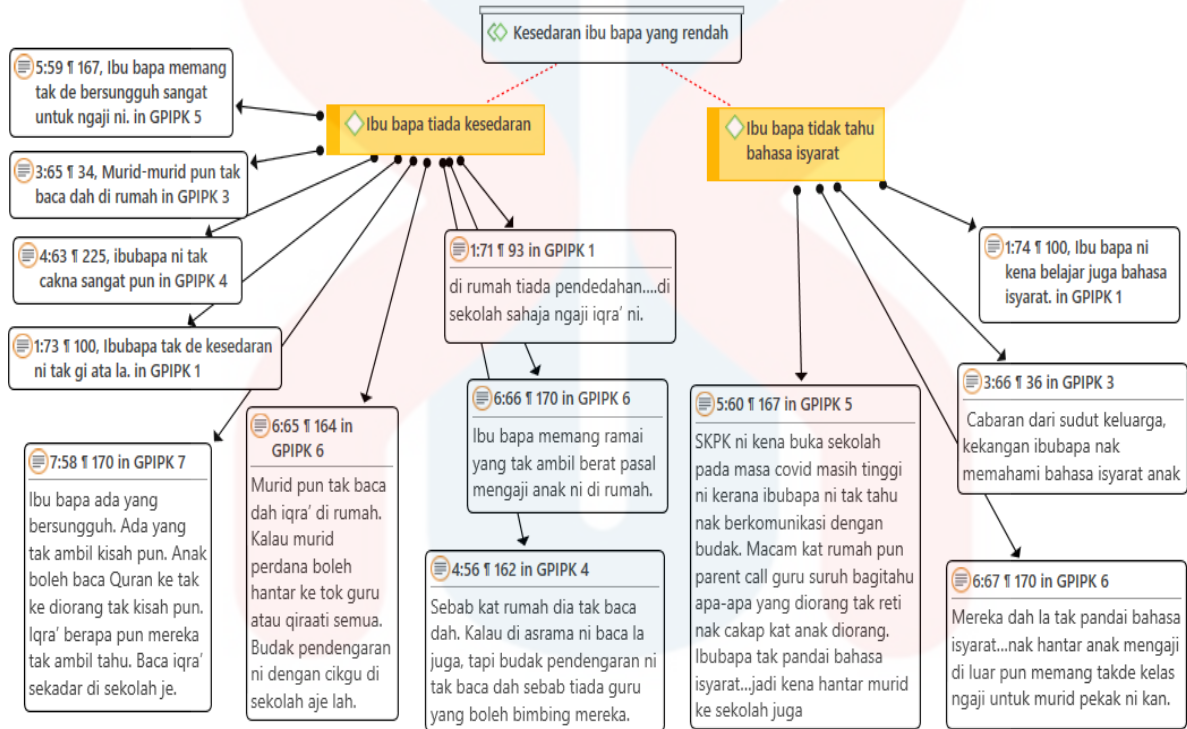

Keupayaan murid yang terhad

Isu keupayaan murid yang terhad ini timbul dari kod murid lemah daya ingatan dan tahap pendengaran mempengaruhi kecerdikan. Kebanyakan guru mengatakan murid yang mempunyai tahap pekak yang sedikit agak cerdik berbanding mereka yang mempunyai tahap pekak yang tinggi. Walau bagaimanapun majoriti murid susah untuk mengingat dan perlu selalu mengulang-ulang. Rajah 9 berikut merupakan kata-kata peserta kajian berkaitan isu kesedaran ibu bapa yang rendah.

Rajah 9. Kategori Keupayaan Murid Yang Terhad

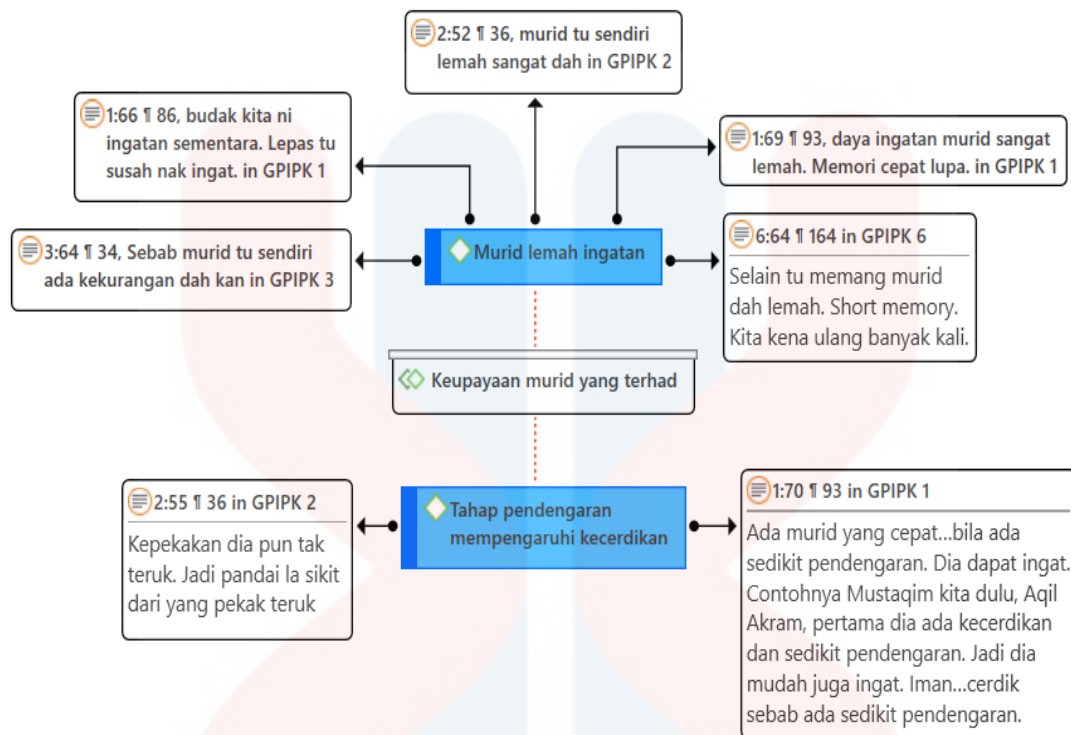

KESIMPULAN

Kajian ini telah memberi pendedahan berkaitan isu dan cabaran yang wujud dalam pelaksanaan pengajaran iqra' guru Pendidikan Islam dalam kalangan murid berkeperluan khas masalah pendengaran. Dapatan yang diperoleh menunjukkan faktor guru, ibu bapa dan murid itu sendiri merupakan faktor terbesar dalam memastikan pengajaran iqra' dapat dilaksanakan dengan baik. Semua semua pihak yang terlibat perlu meneliti setiap isu dan cabaran yang wujud bagi menangani sebarang permasalahan yang timbul dan seterusnya membantu dalam meningkatkan pencapaian akademik murid, khususnya mata pelajaran al-Quran murid-murid pekak.

Bagi isu dan cabaran dalaman yang wujud, ia melibatkan peranan guru itu sendiri dan juga pihak atasan seperti pihak pentadbir, JPN serta KPM. Masa yang diperuntukkan untuk tasmik perlu dikaji kembali dan mungkin sistem kolaborasi perlu dilaksanakan sebagaimana yang digariskan dalam program j-QAF. Guru-guru perlu dibantu dengan perbanyakkan kursus bagi meningkatkan kemahiran dan motivasi guru. Pelbagai kaedah boleh difikirkan untuk menambah dan meningkatkan motivasi dalaman guru. Tanpa guru yang bersemangat dan bermotivasi, maka pudarlah proses pdpc di dalam kelas.

Isu dan cabaran luaran yang wujud melibatkan pihak ibu bapa dan murid. Pihak kerajaan bertanggungjawab membantu memberikan kursus-kursus kepada ibu bapa yang mempunyai anak OKU. Contohnya, kursus bahasa isyarat untuk orang awam perlu dilaksanakan, selain program motivasi keibubapaan untuk menambah ilmu pengetahuan berkaitan penjagaan anak istimewa. Faktor murid itu sendiri lemah dan keupayaan yang terhad tidak dapat dibantu melainkan ibu bapa, guru, orang awam dan kerajaan itu sendiri yang memberi sokongan yang jitu kepada anak-anak ini untuk berusaha dengan lebih keras agar masa depan mereka lebih terjamin. Rajah 10 di bawah adalah kesimpulan berkaitan isu dan cabaran guru Pendidikan Islam dalam pengajaran iqra' murid berkeperluan khas pendengaran.

Rajah 10. Kesimpulan Isu dan Cabaran GPIPK

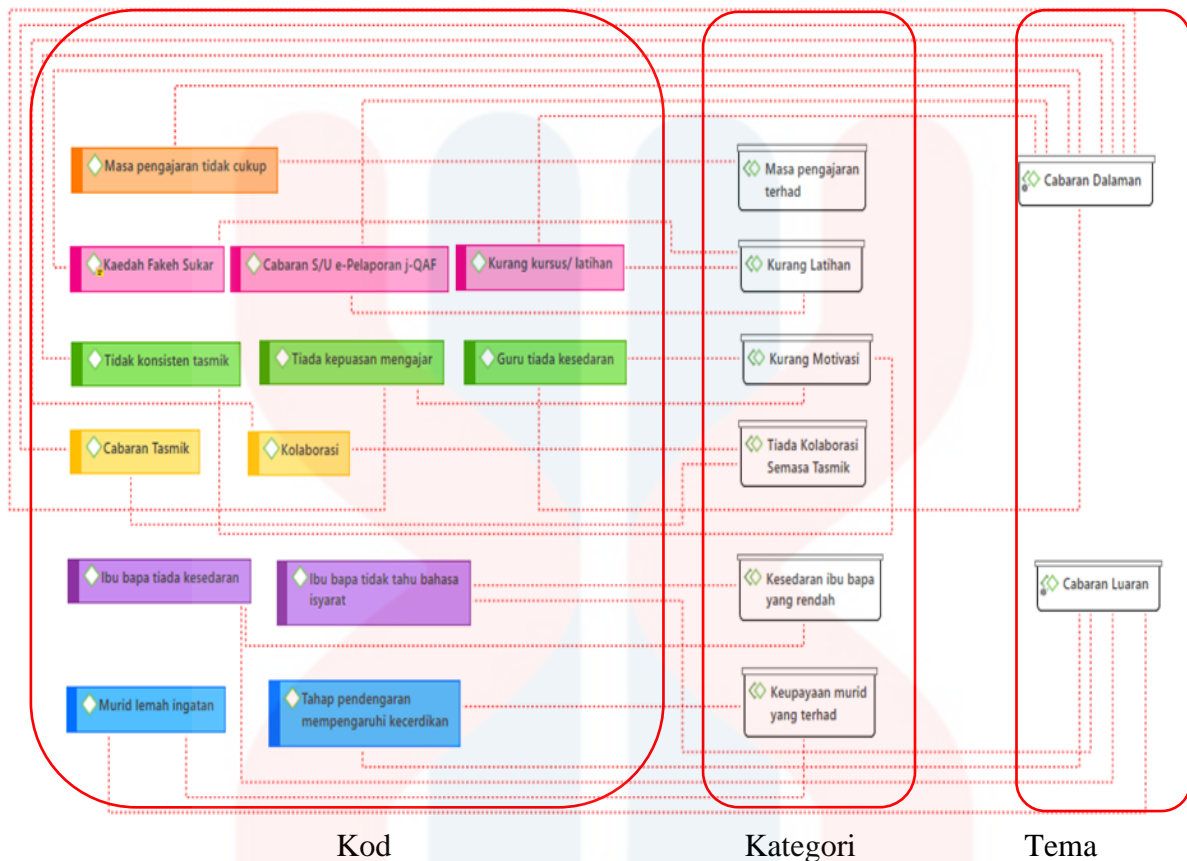

RUJUKAN

- Azmil Hashim, Zaki Ismail, & Siti Khairul Bahriah Rasol. (2020). Relating teaching practices to student achievement in the field of Ibadah (Worship). *International Journal of Innovation, Creativity and Change*, 11(5), 410–417.
- Bahagian Pendidikan Khas. (2008). *Buku panduan pelaksanaan kaedah iqra' j-QAF di Pendidikan Khas*. Kementerian Pendidikan Malaysia.
- Hamdi Ishak, Ab Halim Tamuri, Rosadah Abdul Majid, & Safani Bin Bari. (2012). Amalan pengajaran guru dalam pengajaran dan pembelajaran Pendidikan Islam di Sekolah Kebangsaan Pendidikan Khas (Masalah pendengaran). *Journal of Islamic and Arabic Education*, 4(2), 11–24.
- Hamdi Ishak, Mohd Hanafi Mamat, Mohd Faizulamri Mohd Saad, & Sabri Mohamad. (2019). *Learning and student's achievement factors in j-QAF Khatam al-Quran Model*. 41(2), 29–38.
- Hifzan Mat Hussin, Kamarulzaman Abdul Ghani, & Norazmi Anas. (2022). Amalan pengajaran guru Pendidikan Islam dalam pengajaran iqra' murid berkeperluan khas (pendengaran): Satu kajian rintis. In Muhd Imran Abd Razak, Ahmad Rozaini Ali Hasan, & Shahril Nizam Zulkipli (Eds.), *Paradigma ilmu Islam dan realiti semasa* (First edit). Universiti Teknologi MARA Cawangan Perak.
- Merriam, S. B. (2009). *Qualitative research* (second edi). Jossey-Bass A Wiley Imprint.
- Mohd Fadzli Ismail, & Mohd Sukki Othman. (2012). Faktor-faktor yang mempengaruhi pencapaian pelajar dalam pengajaran & pembelajaran Bahasa Arab: Satu tinjauan di SMAP Kajang. *Persidangan Kebangsaan Pengajaran Dan Pembelajaran Bahasa Arab 2012 (PKEBAR'12)*.
- Mohd Nahi bin Abdullah. (2018). *Amalan pengajaran tilawah al-Quran berkesan dalam*

kalangan guru Pendidikan Islam.

- Mohd Yusri Ibrahim. (2017). *Sembang Santai Penyelidikan*. Firdaus Press Sdn. Bhd.
- Muhammad Zaid Abdul Samat, & Rosadah Abd Majid. (2020). Implikasi kaedah Tahfiz Akhyar terhadap pembelajaran dan pengajaran Surah Al-Fatihah kepada murid pekak. *Journal of Quran Sunnah Education & Special Needs*, 4(2), 34–44. <https://jqss.usim.edu.my/index.php/jqss/issue/view/10>
- Othman Lebar. (2018). *Penyelidikan kualitatif: Pengenalan kepada teori dan metode* (2nd ed.). Universiti Pendidikan Sultan Idris.
- Rabiatuladawiyah Saleh, & Mohd Nizam Sahad. (2019). Senario pembelajaran al-Quran murid masalah pembelajaran (Kefungsian sederhana). *International Research Journal of Shariah, Muamalat and Islam*, 1(1), 07–13. <https://doi.org/10.35631/irjsmi.11002>
- Siti Patonah Mohamad, M.Y. Zulkifli Mohd Yusoff, & Durriyah Sharifah Hasan Adli. (2014). Pengajaran dan pembelajaran al-Quran bagi golongan kelainan upaya mental: Analisis dari sumber tradisi Islam. *Jurnal Islam Dan Masyarakat Kontemporari*, 8(Jun), 1–19.
- Ummu Karamah Alias, Hamdi Ishak, & Sabri Mohamad. (2019). Kaedah-kaedah bacaan al-Quran dalam kalangan orang kurang upaya pendengaran. *Jurnal Al-Turath*, 4(2), 59–67. <http://spaj.ukm.my/jalturath>
- Yin, R. k. (2013). *The case study crisis : Some answers*. 26(1), 58–65.

UNIVERSITI
MALAYSIA
KELANTAN

Pendekatan Pemikiran Metakognitif Dapat Meningkatkan Pemeliharaan dan Pemuliharaan Alam Sekitar di Kalangan Pelajar Sekolah Rendah

Fatimah Ahmad

*1 Jabatan Pengajian Islam, Pusat Pengajian Umum dan Kokurikulum, Universiti Tun Hussein Onn Malaysia, 86400, Batu Pahat, Johor, Tel: +6013-57597716
fatimahahmad1234@yahoo.com*

Mohd Hisyam Abdul Rahim

*2 Jabatan Pengajian Islam, Pusat Pengajian Umum dan Kokurikulum, Universiti Tun Hussein Onn Malaysia, 86400, Batu Pahat, Johor, Tel: +6019-7408695
Mdhisyam@uthm.edu.my*

Azizul Azra Abdul Razak

Jabatan Pengajian Islam, Pusat Pengajian Umum dan Kokurikulum, Universiti Tun Hussein Onn Malaysia, 86400, Batu Pahat, Johor

Aminah Yusoff

Jabatan Pengajian Islam, Pusat Pengajian Umum dan Kokurikulum, Universiti Tun Hussein Onn Malaysia, 86400, Batu Pahat, Johor

Zaidatul Nadra Zainon

Jabatan Pengajian Islam, Pusat Pengajian Umum dan Kokurikulum, Universiti Tun Hussein Onn Malaysia, 86400, Batu Pahat, Johor

ABSTRAK

Metakognitif merupakan pemikiran aras tinggi yang diperlukan dalam melaksanakan tugas kognitif yang kompleks. Ia perlu diberi penekanan kerana kognitif dan afektif adalah seiringan dalam penyelesaian sesuatu masalah. kewujudan krisis alam sekitar yang melanda dunia pada hari ini bermula semenjak abad ke-18 lagi kesan daripada krisis Revolusi Industri yang berlaku di Eropah. Pelbagai persidangan di peringkat antarabangsa dan nasional diadakan dalam usaha membentuk amalan baik dan interaksi anggota masyarakat, terutamanya generasi muda dengan persekitaran. Pelbagai program juga telah dilaksanakan untuk mengatasi isu-isu melibatkan alam sekitar daripada berlarutan. Walau bagaimanapun, terdapat beberapa perkara yang berkaitan yang harus dikaji dan diteliti terlebih dahulu agar pelbagai usaha yang telah dilaksanakan dan dirancang benar-benar berkesan dan dapat menerapkan nilai-nilai mampan yang tinggi terhadap alam sekitar di kalangan pelajar, termasuk tanggungjawab bersama dalam memelihara alam sekitar. Ini disebabkan isu pencemaran alam sekitar dilihat semakin kritikal disebabkan oleh sikap manusia yang tidak peduli terhadap isu berkaitannya. Manusialah sebagai penyebab utama terhadap kerosakan alam sekitar. Pemeliharaan dan pemuliharaan alam sekitar perlu diambil peranan dengan penuh tanggungjawab oleh semua pihak dengan komitmen yang tinggi demi kesinambungan generasi akan datang. Melalui pendekatan metakognitif yang dijalankan terhadap pelajar-pelajar diharapkan kajian ini sebagai pemangkin usaha alternatif dalam pemeliharaan dan pemuliharaan alam sekitar.

Kata kunci: metakognitif, alam sekitar

PENGENALAN

Kehidupan manusia bukan sahaja melibatkan perhubungan manusia dengan manusia tetapi juga melibatkan hubungan dengan alam sekitar. Keharmonian, kedamaian dan kesejahteraan manusia di dunia ini adalah disebabkan adanya persefahaman dan terjalinnya hubungan yang harmoni di antara manusia dengan alam sekitar. Justeru, sikap manusia yang inginkan kesenangan dan kemewahan, merupakan satu sikap penaklukan terhadap alam sekitar dengan menggunakan teknologi terkini yang dimiliki tanpa memikirkan apakah implikasi yang akan diterima samada oleh individu, masyarakat, negara dan dunia. Kesan pengeksploitasian yang tidak seimbang, berlakulah pencemaran alam sekitar yang menyumbang kepada berlakunya pelbagai tragedi yang menakutkan seperti runtuhnya bangunan pencakar langit, gelombang tsunami dan pencemaran sungai sehingga menyebabkan kerugian yang bukan sedikit dan menyebabkan kehilangan nyawa yang bukan sedikit.

Isu pencemaran yang melibatkan alam sekitar bukan perkara yang baru tetapi merupakan isu yang dialami oleh hampir seluruh negara di dunia. Ia merupakan satu isu global yang semakin dipandang serius oleh semua negara dan ini dibuktikan melalui pelbagai persidangan dunia seperti Persidangan Stockholm dengan dihadiri oleh pemimpin-pemimpin negara maju pada tahun 1972, yang pertama kali diadakan bagi membincangkan tentang pencemaran alam sekitar. Masyarakat dunia perlu diberi pengetahuan, kesedaran, dan mempunyai sikap yang bertanggungjawab terhadap alam sekitar.

Kenapakah peranan sikap penting dalam pemeliharaan dan pemuliharaan alam sekitar?. Sikap merupakan tingkah laku manusia dalam kehidupan seharian dan dikategorikan kepada dua bahagian iaitu positif dan negatif. Secara keseluruhannya sikap terhadap alam sekitar, ialah perasaan positif atau negatif yang berterusan dan melibatkan kebolehan intelektual dan pengetahuan sedia ada, serta pengukuran darjah yang melibatkan emosi (Camo & Snow, 1986).

Selain sikap, pemikiran metakognitif juga perlu diterapkan dan disemai kepada semua golongan masyarakat di Malaysia. Ini kerana masyarakat Malaysia perlu dilatih untuk menyelesaikan masalah dan mendapatkan pengetahuan baru. Ia merupakan satu usaha yang sangat mencabar kerana melibatkan pelbagai kaedah pengajaran dan pembelajaran bagi menghasilkan satu perubahan yang memberi kebaikan kepada manusia. Diharapkan, isu pencemaran alam sekitar dapat diminimalkan dan semua pihak menyedari peranan dan tanggungjawab masing-masing dalam mengatasi permasalahan alam sekitar.

TINJAUAN LITERATUR

Di sini pengkaji mengetengahkan beberapa kajian lepas mengenai isu-isu yang melibatkan alam sekitar yang telah dijalankan oleh pengkaji-pengkaji terdahulu.

Kajian yang dijalankan oleh Sulaiman Kadikon dan Abidah Raudzah Othman (2010) mengenai peranan dan tanggungjawab dalam melaksanakan program penggunaan semula bahan-bahan terpakai menurut perspektif Islam. Kajian ini telah dijalankan ke atas 123 orang responden yang terdiri daripada pelajar pengajian Ijazah Sarjana Muda Sains serta Pendidikan di Universiti Teknologi Malaysia. Keputusan yang diperolehi mendapati bahawa 36% pelajar memberikan persepsi yang positif dan memahami mengapakah program kitar semula dijalankan.

Seterusnya kajian yang dijalankan oleh Zahari Mahad Musa (2010), dalam bidang Fiqh al-Bi'ah. Ia merupakan kajian yang melibatkan hubungan di antara manusia dengan alam sekitar. Fiqh al-Bi'ah merupakan satu bidang yang terdapat dalam undang-undang Islam, yang dilihat dapat membantu dalam usaha meminimalkan krisis berkaitan alam sekitar sehingga ke peringkat global. Dalam kajian ini keseluruhan masyarakat dari pelbagai peringkat perlu bertanggungjawab dalam menangani masalah pencemaran alam sekitar berdasarkan al-Quran dan al-Sunnah. Manusia dikurniakan akal fikiran dan di sini terletaknya kebijaksanaan manusia untuk mentadbir alam sekitar supaya terus terpelihara dan memberi manfaat kepada generasi akan datang.

Ibrahim Abdul Matin (2010) dalam kajiannya telah menyatakan apakah langkah-langkah yang digariskan oleh Islam untuk memakmurkan bumi ini. Beliau telah menyatakan bahawa, manusia adalah makhluk yang dikurniakan akal fikiran dan seharusnya berusaha bersungguh-sungguh mengelakkan alam ini daripada tercemar kerana ia merupakan satu anugerah Allah SWT yang tidak terhingga. Beliau juga telah menghuraikan peranan seorang muslim sebagai hamba Allah SWT dalam mengurus alam sekitar dan turut menyeru kepada penganut-penganut agama lain untuk bersama-sama berganding bahu memainkan tanggungjawab bersama menjaga alam sekitar.

Noor Shakirah Mat Akhir (2011) dalam kajiannya telah membincangkan tentang peranan pelbagai agama di Malaysia seperti Islam, Buddha, Kristian dan Hindu tentang pentafsiran berkaitan permasalahan alam sekitar. Kajian ini menunjukkan bahawa tanggapan pelbagai agama adalah sama mengenai alam sekitar, di mana manusia perlu menjaga amanah tuhan dan perlu memainkan peranan dan tanggungjawab mengurus alam sekitar dengan baik.

Seterusnya, Kajian Tan dan Norzaini Azman (2011) terhadap 360 orang responden yang terdiri daripada pelajar prasiswazah dari Universiti Kebangsaan Malaysia. Dalam kajian ini menunjukkan aliran pengajian di kalangan pelajar mempengaruhi sikap keperihatinan dan tanggungjawab terhadap alam sekitar. Hasil kajian juga menunjukkan bahawa pelajar tidak menunjukkan komitmen yang tinggi, bersikap sederhana dalam isu-isu yang melibatkan alam sekitar dan tidak suka melibatkan diri dalam program yang melibatkan alam sekitar.

Satu kajian yang dijalankan oleh Jamilah Hj Ahmad, Hasrina Mustafa, Hamidah Abd Hamid dan Juliana Abdul Wahab bertajuk “Pengetahuan, Sikap dan Amalan Masyarakat Malaysia Terhadap Isu Alam Sekitar” (2011) mendapati bahawa tahap pengetahuan masyarakat adalah berbeza mengikut isu yang diketengahkan. Tahap pemikiran rakyat Malaysia masih ditahap sederhana dan tahap amalan pula ditahap yang rendah. Sebagai contohnya pengetahuan mengenai penggunaan bahan kitar semula adalah sederhana jika dibandingkan dengan pengetahuan berkaitan dengan pencemaran udara dan pencemaran bunyi. Masyarakat di negara ini juga lebih mementingkan isu-isu berkaitan dengan bencana alam daripada penggunaan tenaga. Dalam kajian ini juga menunjukkan televisyen adalah sumber utama untuk mendapatkan maklumat, namun masyarakat masih mengutamakan program berbentuk hiburan daripada program berbentuk ilmiah.

Walau bagaimanapun dalam kajian yang dijalankan oleh Nurul Hidayah Liew Abdullah, Haryati Shafii dan Seow (2013), menunjukkan bahawa tahap penguasaan dan pemahaman murid terhadap isu-isu yang berkaitan dengan alam sekitar di tahap yang tinggi. Ini kerana pada masa kini guru-guru banyak menggunakan strategik metakognitif yang menghasilkan pemikiran metakognitif seiring dengan kognitif oleh murid sehingga terhasillah pembelajaran yang sofistikated. Walau bagaimana pun, pengetahuan dan tahap penguasaan

murid terhadap alam sekitar dari aspek metodologi masih di tahap yang rendah disebabkan murid kurang berminat mengenai isu-isu pencemaran alam sekitar. Kajian yang dijalankan ini juga mendapati bahawa wujudnya perkaitan antara persepsi dan sikap murid terhadap alam sekitar.

RESEARCH METHODOLOGY

This study is quantitative in nature involving library research. The data collection methods used were case study analysis, articles, books and discourses. While the data analysis method uses descriptive analysis methods that are appropriate to the objectives of the study to clarify the metacognitive definition, inquiry methods and increasingly chronic environmental pollution issues seem to have no solutions.

ANALISIS DAN PERBINCANGAN

Pengertian Alam Sekitar

Perkataan alam sekitar atau environment di dalam Bahasa English membawa maksud keadaan persekitaran yang melingkungi manusia. Secara khususnya ia merujuk kepada fenomena fizikal yang mempunyai kaitan dengan iklim dan cuaca. Menurut kamus Webster alam sekitar terdiri daripada faktor-faktor fizikal, ekonomi, teknologi, politik, sosial dan kebudayaan (Royston, 1980). Panel Pencemaran Alam Sekitar Amerika Syarikat mendefinisikan alam sekitar sebagai keseluruhan faktor iaitu sosial, biologi, fizikal dan kimia yang membentuk persekitaran kehidupan manusia (Bartelmus, 1986).

Kenapa Masyarakat Perlukan Pendidikan Alam Sekitar

Dewasa ini manusia sering menggunakan kekuasaan untuk merubah persekitaran bagi tujuan pembangunan yang sofistikated sehingga menyebabkan spesis hidup terdedah kepada bahaya pencemaran alam sekitar. Persidangan Bangsa-Bangsa Bersatu di Stockholm pada tahun 1972 telah mengambil kata sepakat bahawa permasalahan yang berkaitan dengan alam sekitar perlu diambil berat oleh semua negara. Kerjasama antara negara-negara di peringkat global sangatlah diperlukan untuk menangani isu-isu berkaitan alam sekitar.

Oleh yang demikian, pengetahuan mengenai alam sekitar harus diberikan kepada keseluruhan masyarakat pada semua peringkat umur samada secara formal atau tidak formal. Pakar-pakar alam sekitar perlu memainkan peranan masing-masing. Semua pihak harus memahami masalah utama dunia kontemporeri dan kenapa masyarakat perlu didedahkan dengan pendidikan alam sekitar. Ini kerana pembangunan yang begitu pesat dan rakus telah mengakibatkan implikasi yang dahsyat kepada persekitaran disebabkan keinginan manusia memenuhi agenda pembangunan (Jamaluddin Md. Jahi 2001). Implikasi daripada pelbagai aktiviti-aktiviti pembangunan yang melampaui batas juga antara yang menyebabkan alam sekitar semakin tercemar sehingga mengakibatkan pelbagai bencana alam (Jamaluddin Md Jahi, 2001). Kesan daripada kerakusan manusia, pelbagai pencemaran yang merosakkan keindahan alam sekitar berlaku sehingga terjejasnya sumber kehidupan manusia dan haiwan, menjejaskan kesihatan manusia dan menyebabkan pelbagai jenis penyakit yang merbahaya seperti Minimata di Jepun, kecacatan anggota akibat kesan radiasi dan kabut fotokimia di Los Angeles (Ku Halim Ku Hamid, 1995).

Pembangunan di kawasan tinggi juga menyebabkan hakisan dan berlakunya fenomena tanah runtuh. Ini telah dibuktikan dengan satu tragedi yang menggemparkan negara pada tahun 1993 iaitu tragedi runtuhnya Highland Towers sehingga mengakibatkan 170 orang nyawa

terkorban. Selain itu dalam laporan <http://www.reach.org.my> TV3 melalui Buletin Utama pada 17hb Februari 2006 telah menyiarkan berita pencerobohan tanah di sekitar Cameron Highlands sehingga berlakunya proses hakisan tanpa sekatan yang menyebabkan tanah runtuh, mengorbankan nyawa manusia, mengakibatkan kemusnahan hutan secara berleluasan dan menjejaskan aktiviti tanaman ladang teh yang menjadi sumber ekonomi Cameron Highlands. Sikap kerakusan manusia dalam menjalankan pembangunan di kawasan tanah tinggi juga telah mengakibatkan kemusnahan habitat semulajadi seperti spesis tumbuh-tumbuhan, haiwan dan serangga. Ia juga menyebabkan berlakunya pemendapan dalam sungai sehingga sungai menjadi cetek. Keadaan seperti ini akan menimbulkan bencana alam seperti banjir. Ini dibuktikan melalui laporan Utusan Malaysia (18 Februari 2005), di mana satu banjir besar telah berlaku pada tahun 2003 di Taman Pertanian Bukit Cahaya Seri Alam sehingga menyebabkan kampung Budaya banjir besar dan mengakibatkan kerugian yang besar. Pembukaan tanah yang melibatkan kawasan penempatan baru bagi menjalankan pelbagai aktiviti pembangunan juga antara punca utama berlakunya hakisan tanah sehingga mengakibatkan berlakunya bencana alam yang banyak merosakkan harta benda dan mengorbankan jiwa manusia (Haliza, 2007).

Hasil kajian juga mendapati terdapat banyak sungai-sungai yang telah mengalami pencemaran di tahap yang sangat kritikal terutamanya di negeri-negeri yang mengalami pembangunan secara mendadak dari sektor perkilangan seperti Pulau Pinang, Kuala Lumpur, Selangor dan Johor (Utusan Malaysia, 4 Februari 2007). Sebagai contoh, kualiti air sungai di Selangor telah mengalami masalah pencemaran yang sangat kritikal hasil daripada pembuangan sisa toksik daripada kilang hingga menyebabkan pelbagai sektor ekonomi mengalami kerugian berjuta ringgit.

Pencemaran udara juga berada pada tahap yang sangat membimbangkan. Ia berpunca daripada kegiatan manusia yang begitu rakus melakukan pelbagai pembangunan tanpa mengikut garis panduan yang telah ditetapkan. Pembakaran sampah sarap secara berleluasa di kawasan perumahan dan pembakaran melibatkan aktiviti keagamaan turut menyumbang kepada berlakunya peningkatan pencemaran udara (Jabatan Alam sekitar, 2013). Pertumbuhan ekonomi dari sektor perkilangan di Malaysia juga merupakan antara penyebab berlakunya peningkatan pencemaran udara yang sangat mencemaskan (Jabatan Alam sekitar, 2011). Pelupusan bahan-bahan tanpa sekatan menyebabkan masalah pencemaran kian meruncing dan memberi kesan kepada manusia, haiwan dan tumbuh-tumbuhan.

Nilai kesedaran dan sivik yang rendah dalam diri manusia juga antara penyumbang kepada pencemaran alam sekitar. Sikap ketidakpedulian dan mementingkan diri sendiri seperti suka membuang sampah merata-rata menyebabkan masalah ini seperti tiada penghujungnya. Keadaan ini telah menyebabkan kerajaan menanggung kerugian yang besar kerana terpaksa membelanjakan sejumlah besar peruntukan kewangan untuk mengatasi pelbagai perkara yang menyebabkan pencemaran alam sekitar.

Apakah Peranan Kerajaan Dalam Mengatasi Masalah Pencemaran Alam Sekitar

Berikutan dengan pelbagai situasi yang dialami, sehingga memberi kesan tidak baik kepada negara dan bagi mengatasi isu-isu tersebut dengan jayanya, pelbagai program dan kursus-kursus telah diperkenalkan oleh pihak kerajaan. Pelbagai persatuan yang berkaitan dengan alam sekitar samada dari agensi kerajaan atau pun bukan kerajaan turut memainkan peranan penting dalam usaha untuk mengatasi pelbagai isu melibatkan alam sekitar seperti Persatuan Perlindungan Alam Sekitar (EPSM), Persatuan Pengguna Pulau Pinang (CAP) dan Gabungan Persatuan Pengguna Malaysia (FOMCA). Selain itu juga dalam usaha untuk mengatasi pencemaran alam daripada berleluasa, kerajaan juga telah mewujudkan Dasar Alam Sekitar Malaysia 1976 dan Akta Kualiti Alam Sekitar 1974 yang bertanggungjawab melaksanakan peruntukan-peruntukan akta serta pengawasan alam sekitar. Semua aktiviti pembangunan yang

dijalankan perlu ada garis panduan dan mengikut piawaian yang tertentu (Kementerian Penerangan Malaysia, 2011).

Dasar Alam Sekitar Negara (DASN) yang dilancarkan pada 14 November 2002, juga merupakan salah satu usaha kerajaan dalam menangani masalah pencemaran alam sekitar. Dalam DASN, Kementerian Sains dan Alam Sekitar (2002) menyatakan bahawa bagi mendalami konsep kesejahteraan alam sekitar, sikap prihatin terhadap alam, pendidikan dan kesedaran alam sekitar adalah digalakkan secara menyeluruh dengan penggabungan penyebaran maklumat serta latihan selaras dengan cadangan-cadangan dalam Agenda 21. Oleh itu, berlakunya peningkatan samada dari segi ekonomi, sosial, budaya dan kualiti hidup rakyat adalah berdasarkan keharmonian alam sekitar dan pembangunan lestari (Mumtazah, 2001).

Apakah Sikap Masyarakat Malaysia Terhadap langkah-langkah Yang Diambil Oleh Kerajaan Dalam Menangani Isu pencemaran Alam Sekitar

Pelbagai langkah dan pendekatan telah diambil oleh kerajaan, namun sikap tidak keperdulian dan tidak bertanggungjawab masyarakat dalam mengawal alam sekitar menyebabkan penyelesaian isu berkaitan alam sekitar seperti tiada jalan penyelesaian. Oleh yang demikian, kerajaan telah mengambil langkah menggubal undang-undang berkaitan alam sekitar, menjalankan pelbagai bentuk kempen dan program kesedaran serta penguatkuasaan undang-undang. Namun ia masih tidak memberi kesedaran dan kesan kepada rakyat Malaysia. Kebanyakan program hanya mendapat sambutan di peringkat awal saja. Selepas program tamat kebiasaannya keadaan akan kembali kepada asal, tanpa penghayatan diri untuk berlakunya perubahan seperti yang diharapkan. Sebagai contoh, hasil kajian tentang kesedaran manusia terhadap alam sekitar masih ditahap yang rendah iaitu 39%. Keadaan ini amatlah mengecewakan kerana segala usaha dipandang ringan sedangkan kesemuanya melibatkan perbelanjaan yang bukan sedikit. Justeru kenapakah isu ini seperti tiada kesudahannya. Faktor ini disebabkan oleh sikap masyarakat kita yang hanya mementingkan urusan harian mereka tanpa mengambil kira etika alam sekitar (Ashaario, 2009).

Apakah Kesan Kepada Negara Jika Pencemaran Alam Sekitar Masih Tidak Dapat Diatasi

Implikasi yang hebat kepada negara seperti berlakunya kerugian dari segi kewangan disebabkan kerajaan terpaksa mengeluarkan perbelanjaan yang besar untuk mengadakan pelbagai langkah pencegahan. Ia pastilah memberi impak yang negatif samada dari segi ekonomi, politik dan sosial.

Adakah Perkaitan Dengan kurangnya Penghayatan Agama

Krisis alam sekitar juga dikaitkan daripada kurangnya penghayatan agama (Seyyed Hossein Nasr, 1996). Ini disebabkan asas kerohanian yang tidak kukuh akan menyebabkan kurangnya penghayatan terhadap isu-isu pencemaran alam sekitar. Sikap mementingkan diri ditambah kurangnya nilai-nilai murni dalam diri menyebabkan kurangnya penghayatan dalam jiwa untuk bersama-sama mengambil sikap tanggungjawab terhadap alam sekitar.

KESIMPULAN

Matlamat pendidikan alam sekitar yang telah ditetapkan semasa Deklarasi 1977 adalah untuk menggalakkan kesedaran dan keperihatinan terhadap ekonomi, politik, sosial dan saling bergantungan ekologi di bandar juga luar bandar, menyediakan peluang untuk semua orang

memperolehi pengetahuan, sikap, komitmen dan kemahiran untuk melindungi alam sekitar serta untuk menghasilkan perubahan sikap terhadap alam sekitar di kalangan individu, kumpulan dan masyarakat (Modul Pendidikan Alam Sekitar KPLISR, 2010). Adalah diharapkan kajian ini dapat dijadikan bahan rujukan dalam mengenalpasti sebahagian dari aspek-aspek tentang masalah, punca masalah dan cara-cara mengatasi masalah alam sekitar berdasarkan pemikiran metakognitif kepada pihak-pihak yang tertentu.

Kajian ini juga dilihat mampu untuk menyumbang kepada transformasi sistem pembelajaran di sekolah yang berorientasikan murid, melahirkan murid yang berpengetahuan, bersifat pemikir serta mempunyai kesedaran yang tinggi terhadap alam sekitar dan membuat pertimbangan dalam penyelesaian masalah. Seterusnya adalah diharapkan agar kajian ini boleh menjadi pencetus ke arah menghasilkan kurikulum yang mengambil kira pemikiran metakognitif ke dalam kurikulum sedia ada yang melibatkan murid-murid di seluruh negara.

Kajian ini juga diharapkan mampu mencetuskan kesedaran dikalangan guru untuk menghayati serta memperkembangkan kemahiran berfikir aras tinggi secara komprehensif dalam sistem pendidikan di Malaysia. Di samping itu juga, hasil kajian ini juga dapat membantu pihak-pihak yang terlibat untuk mengenalpasti pendekatan berdasarkan pemikiran metakognitif dalam kemahiran-kemahiran lain di sekolah secara amnya.

Dapatan kajian ini juga diharapkan dapat memberi input berguna kepada pihak yang bertanggungjawab dalam merancang kurikulum pendidikan guru seperti Kementerian Pelajaran Malaysia(KPM), Bahagian Pendidikan Guru(BPG), Institut Pendidikan Guru Malaysia(IPGM), Bahagian Perkembangan Kurikulum(BPK), Jabatan Pendidikan Negeri(JPN), Pejabat Pendidikan Daerah(PPD), Jemaah Nazir dan Jaminan Kualiti(JNJK), Pengarah-Pengarah IPGK dan Guru Besar sekolah. Adalah diharapkan hasil daripada kajian ini mampu memberi input yang bermakna bagi pihak-pihak tersebut dalam memperkenalkan pemikiran metakognitif dalam melaksanakannya.

Kajian ini juga dapat memberi input-input yang berguna kepada badan-badan kerajaan yang terlibat secara langsung dengan alam sekitar seperti Jabatan Alam Sekitar(JAS) yang bertanggungjawab dan bertindak untuk menangani isu alam sekitar, jabatan kesihatan dan pihak-pihak kerajaan tempatan bagi menghasilkan penyelidikan bagi penambahbaikan melibatkan alam sekitar.

Selain itu kajian ini juga boleh digunakan oleh badan-badan bukan kerajaan(NGO) dan persatuan-persatuan sukarela yang terlibat dengan aktiviti alam sekitar seperti Persatuan Perlindungan Alam Sekitar (ESPM) sebagai bahan rujukan untuk merancang pelbagai aktiviti yang dapat membantu masyarakat untuk memahami masalah alam sekitar, memberi kesedaran, serta memberikan pendidikan informal kepada masyarakat keseluruhannya.

RUJUKAN

- NorAishah Abdullah (2007), *Islamic Views Towards Contemporary Approach on Environmental Issues*, Universiti Malaya.
- Noor Shakirah Mat Akhir (2004). *Rohani Manusia dan Alam Sekitar dari Perspektif Islam*. Jurnal IKIM, Vol 12, No 2. Julai/Disember. Jabatan Perdana Menteri: Institut Kefahaman Islam Malaysia.

- Abu Bakar Yang (2005). *Pendidikan Alam Sekitar dari Perspektif Islam*. Kertas kerja ini dibentangkan di Seminar Islam al-Hadhari: Kefahaman Mengenai Pemuliharaan Alam Sekitar.
- Kajian Noor Shakirah Mat Akhir (2007) “*Pembinaan Rangka Konsep Pemeliharaan Alam Sekitar Dari Perspektif Abu Hamid al-Ghazali*”, Geran penyelidikan FRGS.
- Kajian Noor Shakirah Mat Akhir (2011). *Alam Sekitar dan Peranan Manusia: Kajian dari Perspektif Pelbagai Agama*, Geran Penyelidikan RU.
- Mikdar Rusdi (2020), *Pemeliharaan dan Pemuliharaan Alam Sekitar Menurut Perspektif al-Quran*. Johor: Universiti Tun Hussein Onn Malaysia.
- Mohd Zuhdi Marsuki & Amir Saaifude GhaZALI (2002). *Etika Alam Sekitar Daripada Perspektif Islam & Timur & Barat*, h. 20.
- Mohd Zuhdi Marsuki & Amir Saifude Ghazali, *Etika Alam Sekitar daripada Perspektif Islam, Timur & Barat* (Bentong: PTS Publications, 2002), 2.
- Ishak Jaino, Pemanasan Global, laman sesawang Dspace, <http://dspace.unimap.edu.my/dspace/bitstream/123456789/7862/1/Pemanasan%20global.pdf>, dicapai 17 April 2011.
- Nurhibah Hasan Zawawi, *Konsep Islam Terhadap Pemuliharaan Alam Sekitar* (Jabatan Perdana menteri: Jabatan Kemajuan Islam Malaysia, 1999), 4.
- Muhammad Ibrahim al-Mishri (1995), 1000 *Tanya Jawab Tentang Islam*, h. 33.

Keberkesanan Pra Ujian Terhadap Pendidikan Tahfiz di Institusi Pengajian Pondok

Wan Zuriaty Ismail
Fakulti Pengajian Bahasa dan Pembangunan Insan
Universiti Malaysia Kelantan
wzuriaty@gmail.com

Nur Azuki Yusuff
Fakulti Pengajian Bahasa dan Pembangunan Insan
Universiti Malaysia Kelantan
nurazuki@umk.edu.my

ABSTRACT

The Effectiveness of Tahfiz Education at the Pondok Study Institution is an education that provides a positive impact and has importance in the country's educational institutions. This study uses qualitative and quantitative methodology. The data obtained was analyzed using SPSS version 22. The total number of respondents involved in this pre-test was a total of 42 people among tahfiz students from several pondok institutions in the state of Kelantan. The pre-test results were done and all the instruments that were built had Cronbach's Alpha reliability values between >0.886 and <0.889 and Cronbach's Alpha based on standardized items was 0.873. Respondents come from tahfiz students from pondok institutions who have the skills to use only one mashaf to memorize the Qur'an which is a factor in the effectiveness of tahfiz education. The results of the study found that tahfiz education is very effective in pondok educational institutions. The researcher hopes that the tahfiz education system in pondok institutions will be given due recognition. In conclusion, tahfiz education in lodge institutions is very effective and needs to be given attention by the authorities to develop human capital that will succeed in the future and be able to translate the practice of the Quran in life.

Keywords: Education; Tahfiz; Studies; Cottages

ABSTRAK

Keberkesanan Pendidikan Tahfiz di Institusi Pengajian Pondok merupakan pendidikan yang memberikan impak positif dan mempunyai kepentingan dalam institusi pendidikan negara. Kajian ini menggunakan kaedah metodologi kualitatif dan kuantitatif. Data yang diperolehi dianalisis menggunakan SPSS versi 22. Jumlah responden yang terlibat dalam pra ujian ini ialah seramai 42 orang dalam kalangan pelajar tahfiz di beberapa buah institusi pondok negeri Kelantan. Dapatan pra ujian telah dilakukan dan semua instrumen yang dibina mempunyai nilai kebolehpercayaan Alpha Cronbach di antara >0.886 dan <0.889 dan Alpha Cronbach berdasarkan item terpiawai ialah 0.873. Responden berasal daripada pelajar tahfiz dari institusi pondok yang mempunyai kemahiran menggunakan satu mashaf sahaja untuk menghafaz al-Quran yang menjadi faktor keberkesanan terhadap pendidikan tahfiz. Hasil kajian mendapati bahawa pendidikan tahfiz sangat berkesan di institusi pengajian pondok. Penyelidik berharap agar sistem pendidikan tahfiz di institusi pondok akan diberikan pengiktirafan yang sewajarnya. Kesimpulannya, pendidikan tahfiz di institusi pondok sangat berkesan dan perlu diberi perhatian oleh pihak berwajib bagi membangunkan modal insan yang berjaya pada masa hadapan dan mampu menterjemahkan amalan al-Quran dalam kehidupan.

Kata kunci: Pendidikan, Tahfiz; Pengajian; Pondok

PENGENALAN

Pendidikan tahfiz telah bertapak di alam melayu sejajar dengan kedatangan Islam. Ia diperkenalkan di surau, masjid dan rumah tuan guru dalam bentuk yang tidak formal (Fazlullah Shuib, 1995) dan digandingkan bersama-sama mata pelajaran asas Islam yang berkaitan fardhu ain dan fardhu kifayah. Sarjana menggelarkannya sebagai pengajian *Alif Ba Ta* atau sekolah al-Quran (Abdullah Ishak 1995, Shamsul A.B. 2002, Rosnani Hashim 2004). Kaedah pembelajaran memberi fokus kepada proses mengenal,mengeja dan menghafaz bermula dari Mukaddham hinggalah kepada surah lain di dalam al-Quran. Guru pula terdiri dari mereka yang arif tentang ilmu al-Quran (Md. Jani Naim 1980). Sememangnya “title” seorang hafiz atau hafizah al-Quran sangat tinggi darjat dan martabatnya di sisi Allah S.W.T dan dipandang mulia di sisi manusia. Kemuliaan ini kerana ia adalah satu amanah langsung dari Allah S.W.T ke atas mereka untuk bertanggungjawab terhadap penjagaan hafazan. Selepas seseorang itu menghafaz keseluruhan al-Quran, ia hendaklah memelihara dan mengekalkannya supaya hafazan tersebut tidak hilang dari ingatan (Mohd Fauzi, 1999). Firman Allah swt, ayat 29 surah Fathir:

إِنَّ الَّذِينَ يَتْلُونَ كِتَابَ اللَّهِ وَأَقَامُوا الصَّلَاةَ وَأَنفَقُوا مِمَّا رَزَقْنَاهُمْ سِرًّا وَعَلَانِيَةً يَرْجُونَ تِجَارَةً لَّن تَبُورًا الَّذِينَ يَتْلُونَ كِتَابَ اللَّهِ وَأَقَامُوا الصَّلَاةَ وَأَنفَقُوا مِمَّا رَزَقْنَاهُمْ سِرًّا وَعَلَانِيَةً يَرْجُونَ تِجَارَةً لَّن تَبُورًا

Sesungguhnya orang-orang yang selalu membaca kitab Allah dan mendirikan shalat dan menafkahkan sebahagian dari rezeki yang Kami anugerahkan kepada mereka dengan diam-diam dan terang-terangan, mereka itu mengharapakan perniagaan yang tidak akan merugi,

(*Fatir:29*)

Daripada Uthman bin Affan r.a, Rasulullah saw bersabda:

خَيْرُكُمْ مَنْ تَعَلَّمَ الْقُرْآنَ وَعَلَّمَهُ

Sebaik-baik daripada kamu adalah yang belajar al-Quran dan mengajarnya

Pengajian pondok merupakan satu institusi pengajian berteraskan Islam yang telah berkembang pesat di alam Melayu khususnya di Malaysia. Ia merupakan tempat pengajian formal yang terawal dibentuk oleh pengasasnya mengikut kekuatan pegangan agama Islam pada masa itu sehingga terbentuknya satu organisasi di dalam kawasan tertentu. Institusi pengajian pondok merupakan antara sistem pengajian awal yang tumbuh di negara ini selepas melalui suatu zaman di mana kebanyakan rakyat jelata belajar ilmu secara tidak formal dengan tiadanya sebarang institusi tersusun dan tetap. Kita dapat melihat bagaimana dari dahulu sehingga sekarang sistem pengajian ilmu agama sama ada pengajian kitab atau ceramah di masjid dan surau terus berlangsung sebagai tambahan dan juga pengisian yang penting walau pun telah wujud sistem pengajian yang semakin berkembang dengan pesat melalui sistem pengajian formal yang lebih tersusun. Begitulah juga yang berlaku terhadap institusi pengajian pondok yang terus kekal walau pun tidak serancak zaman kegemilangannya dalam mengeluarkan golongan faham agama yang mampu bergerak bersama arus perdana dalam menyumbangkan khidmat dan bakti demi kepentingan agama dan negara. Institusi pengajian pondok dengan falsafah pendidikannya yang tersendiri di samping beberapa keistimewaan yang tidak mampu diambil alih oleh sistem pendidikan moden tetap menjadi pilihan sebagai pusat pendidikan alternatif sehingga ia mampu bertahan sehingga hari ini.

Dengan permasalahan yang dibentangkan diharap kajian ini dapat menganalisis keberkesanan pengajian tahfiz di pondok dan maahad tahfiz dan menetapkan elemen-elemen

yang menjadi kekuatan untuk memartabatkan lagi pendidikan tahfiz di institusi pengajian pondok Kelantan.

SOROTAN KAJIAN

Isu berkenaan pendidikan tahfiz telah lama dibincangkan oleh sarjana pendidikan ahli akademik di Malaysia. Aspek ini meliputi teknik pengajaran, sistem pendidikan dan sebagainya. Secara umumnya, terdapat faktor yang menjadikan pendidikan tahfiz berkesan di institusi pengajian pondok.

Keberkesanan Pendidikan Tahfiz Di Institusi Pengajian Pondok

Al-Quran merupakan sebuah kitab yang penuh dengan pelbagai mukjizat serta satu elemen yang terpenting di dalam kehidupan umat Islam selaras dengan matlamat penurunan Al-Quran sebagai sebuah kitab suci yang memberi peringatan, rahmat dan mawaddah kepada seluruh manusia, juga menerapkan nilai-nilai murni yang amat penting dalam diri masyarakat Islam. Matlamat terpenting pendidikan al-Quran ialah mendidik manusia supaya mengabdikan diri kepada Allah SWT. Dalam masyarakat yang dilanda arus globalisasi, pembelajaran al-Quran secara hafalan mampu menjadi pemangkin ke arah membentuk minda manusia yang bakal melahirkan generasi yang hafiz, alim, dai'e dan sekali gus memenuhi matlamat pendidikan al-Quran.

Menurut Ismail Masyhuri (1993), antara kelebihan-kelebihan lain yang diperoleh oleh penghafaz al-Quran adalah selalu dilindungi oleh Allah SWT, menjadi umat Nabi Muhammad SAW yang mulia, tidak merasa takut pada hari kiamat dan doanya akan dimakbulkan oleh Allah SWT. Selain itu, mereka yang menghafaz al-Quran juga merupakan mereka yang paling layak untuk menjadi imam serta dipermudahkan segala urusan mereka. Oleh itu, Allah SWT telah mempermudah kepada manusia untuk menghafaz al-Quran dan memelihara isi kandungannya supaya al-Quran terpelihara dari segala bentuk penyelewengan dan perubahan. Pendapat ini disokong dan diperkukuhkan pula oleh Mohd Aderi (2003) yang menyatakan untuk menghasilkan pengajaran dan pembelajaran tahfiz yang berkesan kepelbagaian bentuk pengajaran dan pembelajaran perlu dilaksanakan. Penggunaan pendekatan, kaedah, teknik dan aktiviti perlu digabungkan bagi meningkatkan kualiti hafazan al-Quran. Kesemua bentuk pengajaran dan pembelajaran ini apabila digabungkan akan memberi kesan yang baik kepada pencapaian hafazan murid.

Pengajaran dan pembelajaran tahfiz di institusi pondok berlaku dengan dua acara iaitu secara formal dan tidak formal. Secara formal pelajar-pelajar akan memasuki kelas mengikut masa yang telah ditetapkan oleh institusi dan berada untuk sesi pembelajaran sehingga satu masa yang telah termaktub dalam jadual. Secara tidak formal, pelajar-pelajar akan menghafaz di mana-mana saja pada waktu lapang dan bersama dengan ustaz untuk memperdengarkan hafazan mereka. Hal ini berlaku apabila kedua-dua pihak mempunyai kelapangan dan bersedia untuk hafazan. Ini juga merupakan satu faktor keberkesanan hafazan di kalangan pelajar. Kesediaan kedua-dua belah pihak membolehkan pembelajaran boleh berlaku di mana-mana sahaja.

Pendekatan Pendidikan Tahfiz Di Pondok Dan Pengajian Tahfiz

Walaupun keadaan ekonomi global masa kini kian merudung dan bergolak, masih ada juga ibu bapa yang sanggup melabur kewangan mereka dalam pendidikan tahfiz anak-anak mereka. Kadar yuran pengajian yang agak tinggi tidak menghalang ibu bapa untuk memberikan ilmu kebahagiaan akhirat yang dapat membantu mereka menuju syurga Allah. Hal ini disokong oleh

Abd Rahman Abd Ghani (2016) yang mana ibu bapa umat Islam di Malaysia begitu berminat dan ingin terus menghantar anak-anak mereka belajar di institusi tahfiz walupun yuran yang mereka terpaksa bayar agak tinggi. Mereka komited dalam memenuhi gagasan satu keluarga satu hafiz. Ibu bapa merasakan bahawa selain bidang ini mampu membentuk akhlak anak-anak mereka kearah positif, ia juga sebenarnya suatu amalan yang sangat mulia dalam Islam. Mereka juga telah menyedari bahawa dewasa ini sistem pendidikan tahfiz sudah menyamai sistem pendidikan bidang-bidang lain di mana sistem pengajiannya sudah begitu teratur iaitu bermula dari peringkat sekolah rendah lagi sehinggalah ke peringkat universiti. Mereka juga sangat percaya dengan masa depan anak-anak mereka, lebih-lebih lagi telah terbukti bahawa bidang ini mampu melahirkan individu yang cemerlang dalam kerjaya sama ada dalam bidang professional atau pendidikan. Hal ini diperkukuhkan lagi dengan pendapat beliau yang menyatakan bahawa untuk menjadi seorang guru hafiz yang cemerlang, seseorang itu perlu memahirkan diri dalam dua bidang iaitu bidang konten dan pedagogi. Kemahiran dalam bidang konten bermaksud, seseorang guru perlu menguasai kandungan matapelajaran yang berkaitan dengan al-Quran. Para guru hafiz semestinya wajib memiliki kemahiran dalam bidang konten ini kerana tanpanya bagaimana sesuatu ilmu itu dapat dipindahkan. Untuk mejadi seorang guru tahfiz, seseorang perlu lancar dalam bacaan al-Quran serta dapat membaca dengan tajwid yang betul, disamping dapat menguasai teori ilmu tajwid dengan baik. Kaedah pengajaran tahfiz yang diamalkan masa kini lebih tertumpu kepada bidang konten sahaja, sementara bidang pedagogi pula kurang didedahkan. Kalau adapun teknik dan strategi yang dijalankan ia hanyalah yang bersifat tradisional seperti latih tubi (takrar) terhadap hafazan dan ulangan yang dilakukan hamper sepanjang waktu pembelajaran. Guru tahfiz masuk ke kelas dan duduk di hadapan menunggu pelajar tasmik kepadanya. Pelajar yang datang tasmik pula terus datang membaca dan ditegur sekiranya berlaku kesalahan dalam bacaan mereka. Itulah yang berlaku sehingga pelajar khatam 30 juzuk al-Quran. Mungkin kaedah PdP itu akan lebih menarik sekiranya diselitkan dengan elemen-elemen pedagogi seperti diakan terlebih dahulu set induksi, menggunakan ABM yang sesuai seperti laptop dan lcd, ada komunikasi dua hala, penutup dan refleksi. Kaedah pengajaran itu pasti akan lebih berkesan kerana penekannya bukan hanya terhadap talaqqi dan musyafahah semata-mata. Semua elemen ini boleh dan sesuai dilaksanakan, Cuma ia memerlukan pengetahuan, kesungguhan dan kreativiti daripada guru-guru.

METODOLOGI

Metodologi kajian adalah meliputi cara, kaedah dan pendekatan yang digunakan untuk mencapai objektif dan matlamat kajian. Metodologi kajian menjadikan kajian yang dijalankan lebih bersistematik dan perjalanan kajian lebih terarah dalam mencapai objektif. Kajian ini menggunakan pendekatan campuran kuantitatif dan kualitatif. Dalam kajian ini, penyelidik telah membuat kajian rintis bagi menguji kesahan soal selidik, membaiki kesahan dan menambah baik kualiti instrument kajian. Selain itu juga, kajian rintis ini juga bertujuan melatih penyelidik mentadbir dan menguasai sebaik mungkin instrumen yang dibina. Penyelidik menggunakan soalan soal selidik, temubual beberapa orang yang mempunyai kepentingan dalam pentadbiran tahfiz dan pemerhatian sekeliling. Penyelidik juga membuat tinjauan keperpustakaan bagi melengkapkan lagi hasil dapatan kajian ini. Sebanyak 42 borang soal selidik diedarkan kepada responden sebagai pra ujian kajian ini. Soalan soal selidik yang penyelidik sediakan telah disahkan oleh pakar instrumen setelah mendapat kelulusan dari pihak Universiti Malaysia Kelantan. Penyelidik memilih secara rawak 42 orang responden daripada 4 buah pusat tahfiz yang terpilih untuk mendapatkan data dan maklumat. Soalan soal selidik dibahagikan kepada empat bahagian yang meliputi soalan tentang demografi, penilaian terhadap keberkesanan hafazan al-Quran, elemen-elemen untuk memartabatkan institusi tahfiz

dan cadangan serta saranan untuk memartabatkan lagi pendidikan tahfiz di institusi pondok. Hasil daripada soalan soal selidik yang dijawab oleh responden kemudiannya dianalisis dengan menggunakan kaedah *SPSS (Statistical Package for the Social Sciences) versi 22*. Kadar pulangan soal selidik untuk kajian rintis ini ialah 100% dan berjaya dipungut dalam tempoh yang ditetapkan. Data-data yang dikumpulkan ini kemudiannya dianalisis dan diuji melalui ujian kebolehppercayaan menggunakan nilai Cronbach`s Alpha.

ANALISIS DAN DAPATAN KAJIAN

Demografi Pelajar

Rajah 1 di bawah menunjukkan bahawa 42 orang responden bagi kajian rintis ini adalah dari kalangan pelajar yang terdiri 71.4% lelaki dan 28.6% pelajar perempuan (42 orang). Ini membuktikan bahawa pelajar tahfiz di institusi pondok negeri Kelantan didominasi oleh golongan pelajar lelaki.

Rajah 1 Carta Jantina Pelajar

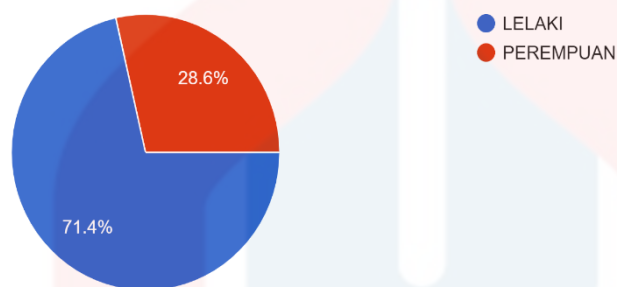

Rajah 2 di bawah menunjukkan kemahiran menghafaz al-Quranyang dimiliki oleh pelajar sebelum memasuki institusi. Keputusan analisis menunjukkan bahawa 52.4% pelajar memiliki kemahiran terlebih dahulu dan 47.6% pelajar yang belum ada kemahiran menghafaz al-Quran. Maka, dapatlah disimpulkan disini bahawa, pelajar yang memiliki kemahiran menghafaz al-Quran adalah lebih ramai daripada yang tidak memiliki kemahiran menghafaz al-Quran. Ini bermakna kualiti penghafaz al-Quran yang memasuki institusi adalah lebih baik.

Rajah 2 Carta Kemahiran Menghafaz Al-Quran

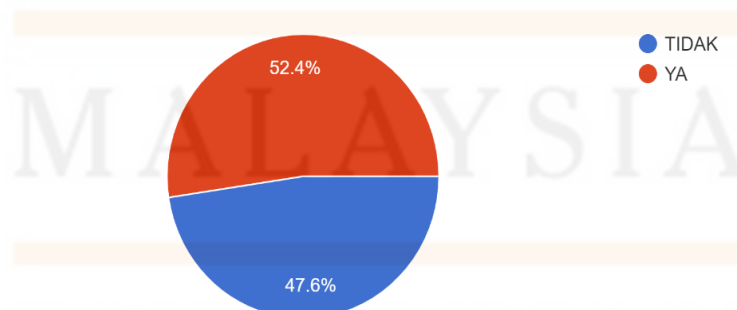

Rajah 3 di bawah menunjukkan bahawa setiap pelajar yang memasuki institusi mempunyai kelayakkan yang diambil kira oleh pusat pengajian. Daripada analisis data yang dibuat seramai 73.8% pelajar lepasan UPSR (Ujian Penilaian Sekolah Rendah) memasuki pusat

pengajian mengatasi pelajar lulusan SPM (Sijil Pelajaran Malaysia) seramai 21.4%. Hanya 4.8% sahaja yang memasuki pusat pengajian yang menggunakan STAM (Sijil Tinggi Agama Malaysia). Kesimpulannya, pelajar yang memasuki institusi pengajian bermula dari peringkat rendah lagi iaitu seawall umur 12-13 tahun.

Rajah 3 Carta Kelulusan Pelajar Sebelum Memasuki Institusi

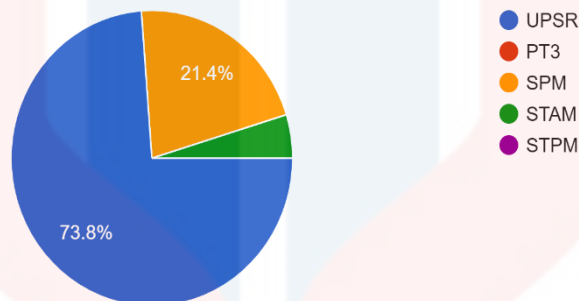

Rajah 4 di bawah menunjukkan bilangan juzuk yang telah dihafaz oleh pelajar sepanjang berada di institusi pengajian. Keputusan analisis menunjukkan bahawa seramai 66.7% pelajar telah menghafaz sebanyak 26-30 juzuk. Diikuti pula seramai 7.1% yang telah menghafaz 1-5 juzuk dan 21-25 juzuk. Hanya 4.8% sahaja yang telah menghafaz 11-15 juzuk dan 16-20 juzuk. Ini menunjukkan bahawa pelajar dapat menguasai hafazan sebanyak 26-30 juzuk mempunyai peratusan yang paling tinggi iaitu 28 orang daripada 42 orang responden.

Rajah 4 Carta Bilangan Juzuk

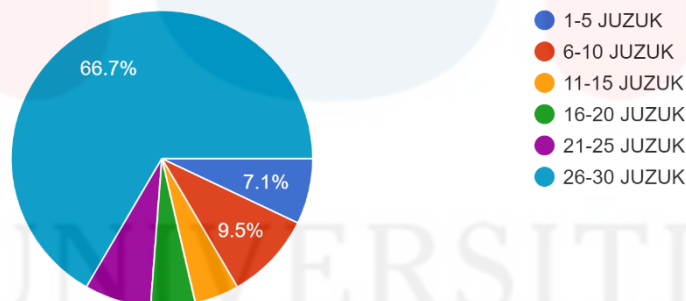

Rajah 5 di bawah menunjukkan keputusan analisis data mengenai tahap penguasaan al-Quran pelajar tahfiz. Pelajar yang mempunyai tahap baik dalam penguasaan al-Quran seramai 73.8% iaitu seramai 31 orang. Sementara yang mempunyai tahap penguasaan sangat baik iaitu 11.9% seramai 5 orang daripada 42 orang. Hanya 14.3% sahaja yang lemah dalam penguasaan al-Quran. Kesimpulannya peratusan yang baik dan sangat baik adalah tinggi dari peratusan yang lemah. Ini menunjukkan pelajar tahfiz mempunyai tahap penguasaan al-Quran yang berkualiti.

Rajah 5 Carta Tahap Penguasaan Al-Quran

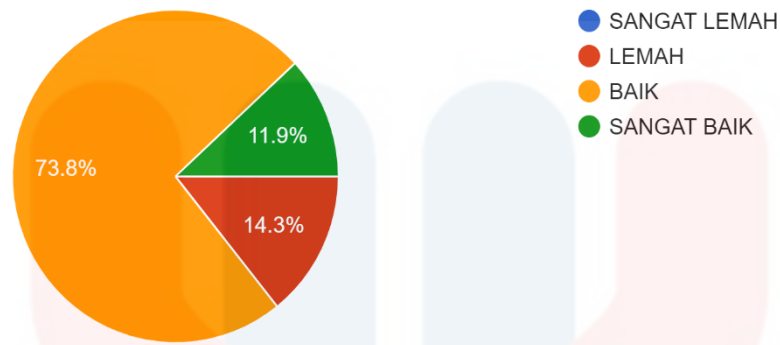

Rajah 6 di bawah menunjukkan tahap penguasaan tajwid dalam pembelajaran al-Quran. Keputusan menunjukkan tiada pelajar yang lemah dan sangat lemah dalam penguasaan ilmu tajwid iaitu 0%. Analisis menunjukkan seramai 61.9% pelajar dalam kategori baik dan 38.1% pelajar dalam kategori sangat baik. Dapat disimpulkan disini bahawa pelajar tahfiz adalah golongan pelajar yang menguasai ilmu tajwid dengan baik.

Rajah 6 Carta Tahap Penguasaan Tajwid

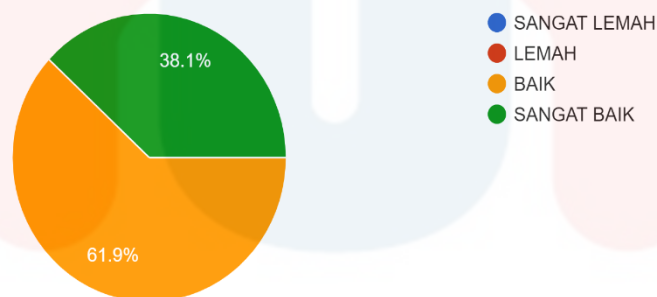

Rajah 7 di bawah menunjukkan analisis hasil keputusan peperiksaan akhir tahun pelajar tahfiz samaada safawi(lisan) atau tahriri (bertulis). Keputusan menunjukkan seramai 35.7% pelajar mendapat keputusan Mumtaz dalam peperiksaan akhir. Kemudian diikuti dengan Jayyid Jiddan seramai 38.1% yang mencatatkan paling ramai. Tahap Jayyid pula adalah seramai 21.4% dan makbul seramai

Rajah 7 Carta Keputusan Peperiksaan Akhir Tahun

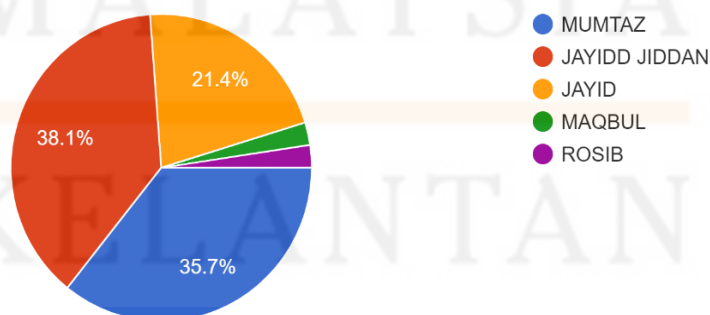

Nilai Cronbach`s Alpha Kajian Rintis

Menurut Cooper dan Schindler (1998) pekali Cronbach`s Alpha digunakan sebagai alat pengukuran tahap konsisten atau reliability yang mempunyai skala interval. Semakin hampir nilai pekali Cronbach`s Alpha kepada 1.0, semakin tinggi kebolehpercayaan item-item tersebut mengukur konsep yang sama. Menurut Sekaran (2003), secara umumnya, nilai kebolehpercayaan di bawah 0.6 dianggap lemah, 0.7 dianggap munasabah untuk diterima dan nilai melebihi 0.8 dikira baik. Walau bagaimanapun bagi Nunnally dan Bernstein (1994), nilai Cronbach`s Alpha di antara 0.6-0.7 boleh diterima. Dalam kajian ini, analisis kebolehpercayaan yang dilakukan selepas analisis reliability mendapati kesemua konstruk yang dibina mempunyai nilai kebolehpercayaan yang baik iaitu

Hasil dapatan kajian yang diperolehi menerusi instrumen soal selidik yang dijalankan ke atas kumpulan responden yang dipilih seramai 42 orang responden. Dapatan kajian ini dianalisis dengan huraian deskriptif bagi melihat Cronbach`s Alpha untuk variabel yang dianalisis. Dapatan kajian ini juga dibentangkan dengan mudah dan jelas serta dipaparkan dalam bentuk jadual yang mudah difahami serta penghuraian yang lebih berkesan. Dalam kajian ini hanya beberapa variabel yang diambil dalam setiap bahagian untuk mengetahui keputusan dapatan yang dikaji. Menurut Mohd Majid (1990), statistik deskriptif merupakan organisasi dan ringkasan data yang diperolehi daripada pemprosesan data atau maklumat.

Dalam kajian ini, analisis kebolehpercayaan yang dilakukan selepas analisis reliability mendapati kesemua konstruk bahagian B mengandungi 26 item yang dibina mempunyai nilai kebolehpercayaan yang baik (melebihi 0.6) dengan reliabiliti keseluruhan ialah 0.899.

Jadual 1 Analisis Ujian Reliabiliti Bahagian B dari Kajian Rintis

Cronbach`s Alpha Based on Standardized Items	No. of Items	Penilaian	Scale if item deleted	Corrected Item-Total Correclation	Cronbach`s Alpha if Item Deleted
0.899	3	Pelajar hanya menggunakan satu mashaf sahaja semenjak mula menghafaz	184.467	.140	.888
		Pelajar menghafaz al-quran lebih dari satu maqra` sehari	170.742	.538	.880
		Guru akan memperdengarkan bacaan dan pelajar mengikutnya sebelum menghafaz	167.780	.661	.887

Berdasarkan rajah 1 di atas, keputusan analisis reliabiliti bahagian tentang penilaian terhadap keberkesanan pendidikan tahfiz di institusi pondok mempunyai nilai kebolehpercayaan yang baik melebihi 0.6 dengan realibiliti 0.899. Ini menunjukkan ujian penilaian terhadap Pra Keberkesanan Pendidikan Tahfiz di Institusi Pondok adalah sangat berkesan dan boleh diterima.

KESIMPULAN

Kesimpulan yang diperolehi hasil daripada analisis dapatan kajian Keberkesanan Pra Ujian Terhadap Pendidikan Tahfiz di Institusi Pengajian Pondok Negeri Kelantan secara umumnya menunjukkan ianya sangat baik dan memuaskan. Walaupun pendidikan tahfiz masih lagi berada di institusi pondok, namun begitu ia sama sekali tidak menjejaskan pembelajaran hafazan serta pendidikan tahriri pelajar. Bahkan, ia dapat melahirkan ramai huffaz yang berkualiti dalam bidang hafazan dan ilmu kitab pondok serta mampu untuk menyebarkan kepada komuniti serta masyarakat setempat. Pendidikan tahfiz di institusi pondok sewajarnya dipandang sebagai cabang pendidikan yang boleh diberikan pengiktirafan dan diangkat sebagai contoh institusi klasik yang sangat memberikan manfaat yang besar dalam dunia pendidikan masa kini.

Faktor profil latar belakang pelajar tahfiz juga menyumbang keberkesanan terhadap pendidikan ini. Ini adalah kerana peratusan pelajar yang mempunyai asas tentang hafazan dan bacaan al-Quran adalah tinggi. Ini menunjukkan bahawa pelajar tahfiz yang memasuki institut pengajian mempunyai asas dalam al-Quran yang baik dari segi bacaan, hafazan dan ilmu tajwid. Berdasarkan asas yang dimiliki ilmu hafazan akan menjadikan pelajar-pelajar huffaz yang disegani harapan bangsa dan agama. Semoga pendidikan tahfiz akan terus bertapak dalam dunia pendidikan sebagai satu cabang ilmu yang diwajibkan dipelajari dan diamalkan dalam kehidupan seharian.

RUJUKAN

Al-Quran al-Karim

- Abdullah, A. R. A.-Q. B. (2011). *Pengajian Tahfiz Al-Quran Dan Qira`At Di Kelantan: Tumpuan Terhadap Sumbangan Dato` Hj Muhammad Nor Bin Ibrahim*. (Phd). Universiti Malaya, Kuala Lumpur.
- Naufal, A. R. (1973). *Al-Quran Wa Al-Ilmu Al-Hadith*. Bairut: Dar Al Arabi.
- Abdullah, A. R. H. (1997). *Pemikiran Islam di Malaysia: sejarah dan aliran*: Gema Insani.
- Mohd Rafi Yaacob, M. K. (2019). *SPSS Versi 22*. UMK.
- Abdullah, A. H., Safar, A., Mustari, M. I., Muhammad, A., & Ismail, I. (2003). Keberkesanan kaedah hafazan di Pusat Tahfiz. *Laporan Penyelidikan, Pusat Pengajian Islam & Pembangunan Sosial: Universiti Teknologi Malaysia*.
- Jemali, M., Daud, M. N., & Ismail, A. M. (2016). Pelaksanaan kurikulum Tajwid di sekolah-sekolah pondok negeri Perak. *Perspektif Jurnal Sains Sosial dan Kemanusiaan*, 8(2), 54-69.
- Jusoh, A. A. B. (1984/85). *Penghayatan Al-Quran Di Kalangan Pelajar-Pelajar Sekolah Menengah; Satu Kajian Khusus Di Sekolah-Sekolah Menengah Jajahan Tanah Merah Kelantan*. (Ijazah Sarjana Muda). UNIVERSITI KEBANGSAAN MALAYSIA, SELANGOR.
- Ahmad, N. (2015). *Memperkasa Darul Quran ke arah memartabat pendidikan tahfiz di Malaysia*.
- Bin Mohamad, S., & bin Hashim, M. D. A. (2016). *Pembangunan Kurikulum Pendidikan Tahfiz: Prinsip Dan Kaedah Dalam Membina Kurikulum Tahfiz Al-Quran. Memperkasa Generasi Penghafaz Al-Quran*, 145.
- Muchlis, M., Maya, R., & Muslim, M. (2020). *Upaya Guru Tahfiz Dalam Meningkatkan Hafalan Juz 30 Kelas Iii Di Sdit Aliya Kota Bogor Tahun Ajaran 2019/2020*. *Prosa PAI: Prosiding Al Hidayah Pendidikan Agama Islam*, 2(2), 102-111.

- Muhammad, D. A. H. (1984). Pendekatan Al-Quran Dalam Penyelesaian Masyarakat Di Malaysia *Jurnal Dakwah Ke Arah Penerapan Nilai-Nilai Islam* (III).
- Muriyah Abdullah, A. H. A., Arieff Salleh Rosman. (2019). *Pendidikan Tahfiz Di Malaysia: Satu Sorotan Sejarah*.
- Noornajihan Jaafar, Z. A. G., Siti Rugayah Hj Tibek. (2017). *Cabaran Institusi Pendidikan Pondok Serta Impak Terhadap Pembentukan Diri Pelajar*. *Journal Of Islamic, Social, Economics And Development*, 2.
- Muhammad, D. A. H. (1984). Pendekatan Al-Quran Dalam Penyelesaian Masyarakat Di Malaysia *Jurnal Dakwah Ke Arah Penerapan Nilai-Nilai Islam* (Iii).
- Ismail, M. J., Mohamad, S., Puji, T. I. Z. T., & Yusof, N. H. (2017). *Strategi Kecemerlangan Institusi Pendidikan Tahfiz Al-Quran Di Malaysia: Satu Tinjauan Literatur*. *Jurnal Islam dan Masyarakat Kontemporari*, 15(1), 55.
- Rianie, N. (2015). *Pendekatan dan Metode Pendidikan Islam (sebuah perbandingan dalam konsep teori pendidikan Islam dan barat)*. *Management of Education*, 1(2).
- Rahim, R. A. A., Yusuff, N. A., Desa, R., & Zakaria, N. B. (2010). *Institusi pondok sebagai penjana intelektual ummah di Kelantan*.

Kepentingan Ihsan dalam Pembentukan Afektif Mahasiswa

Nur Syazwani Othman

Universiti Teknologi Mara (UiTM), Kampus Pasir Gudang, Cawangan Johor
2022550277@student.uitm.edu.my

Mahfuzah Mohammed Zabidi

Universiti Teknologi MARA (UiTM), Kampus Pasir Gudang, Cawangan Johor
mahfuzah3051@uitm.edu.my

Norhapizah Mohd Burhan

Universiti Teknologi MARA (UiTM), Kampus Jengka, Cawangan Pahang
izahuiaum@uitm.edu.my

ABSTRACT

In this era of globalization, the world is filled with various challenges and tribulations. The issue of social symptoms that is getting more and more widespread coverage shows that the affective formation of students is collapsing. In the affective formation of students, good values need to be applied to produce holistic students from the point of responsibility towards themselves, God, society and nature. Thus, the value of ihsan should be highlighted and given priority for affective formation involving the spiritual and emotional domains of humans. This article aims to explain the concept of ihsan and its importance in the affective formation of students. This study applies the design of content analysis by analyzing the text in an inductive and deductive logic that contains debates about ihsan and affective in the context of higher education. The results of the study summarize the importance of ihsan in the affective formation of students from the aspects of i) presenting godly awareness in the student's personality, ii) being a yardstick in determining the quality of worship or work, iii) the formation of noble attitudes and morals and iv) doing good to fellow human beings. All these aspects need to be given attention in order to produce students who are prosperous from a physical, emotional, spiritual and intellectual point of view.

Keywords: *ihsan; affective formation; students; value*

ABSTRAK

Era globalisasi ini, dunia dipenuhi dengan pelbagai cabaran dan tribulasi. Isu gejala sosial yang semakin mendapat liputan meluas menunjukkan pembentukan afektif mahasiswa semakin merundum. Dalam pembentukan afektif mahasiswa, nilai yang baik perlu diterapkan bagi melahirkan mahasiswa yang holistik dari sudut kebertanggungjawaban terhadap diri, Tuhan, masyarakat dan alam. Justeru, nilai ihsan wajar diketengahkan dan diberi keutamaan untuk pembentukan afektif yang melibatkan domain rohani dan emosi manusia. Artikel ini bertujuan menghuraikan konsep ihsan dan kepentingannya dalam pembentukan afektif mahasiswa. Kajian ini mengaplikasikan reka bentuk analisis kandungan dengan menganalisa teks secara logik induktif dan deduktif yang mengandungi perbahasan mengenai ihsan dan afektif dalam konteks pengajian tinggi. Hasil kajian merumuskan kepentingan ihsan dalam pembentukan afektif mahasiswa dari aspek i) menghadirkan kesedaran bertuhan dalam keperibadian mahasiswa, ii) menjadi kayu ukur dalam menentukan kualiti ibadah atau pekerjaan, iii) pembentukan sikap dan akhlak mulia dan iv) berbuat baik kepada sesama manusia. Kesemua aspek ini perlu diberikan perhatian bagi melahirkan mahasiswa yang sejahtera dari sudut jasmani, emosi, rohani dan intelek.

Kata Kunci: *ihsan; pembentukan afektif; mahasiswa; nilai*

PENGENALAN

Peradaban manusia yang diimpikan ialah mahasiswa yang cemerlang akademik dan akhlak. Dalam zaman pembangunan yang serba moden dan berasaskan teknologi, peranan mahasiswa menjadi lebih komprehensif. Mahasiswa merupakan gambaran ataupun imej pemimpin pada masa hadapan (Marzuki et al., 2021). Hal ini kerana mahasiswa merupakan penerus legasi dalam pembangunan, pentadbiran dan pengurusan bagi sesebuah negara.

Selain itu, mahasiswa juga menjadi keperluan di dalam masyarakat dengan memainkan peranan penting antaranya dengan menjadi agen perubahan (*agent of change*), kontrol sosial (*social control*), tulang belakang generasi (*iron stock*) dan suri teladan (*moral force*) (Cahyono, 2019). Matlamat Falsafah Pendidikan Kebangsaan juga memberikan penekanan dari aspek jasmani, emosi, rohani dan intelek (JERI) kepada mahasiswa. Falsafah Pendidikan Kebangsaan (FPK) seperti yang dijelaskan berikut:

“Memperkembangkan lagi potensi individu secara menyeluruh dan bersepadu untuk mewujudkan insan yang seimbang dan harmonis dari segi intelek, rohani, emosi dan jasmani berdasarkan kepercayaan dan kepatuhan kepada Tuhan. Usaha ini adalah bagi melahirkan rakyat Malaysia yang berilmu pengetahuan, berketerampilan, berakhlak mulia, bertanggungjawab, dan berkeupayaan mencapai kesejahteraan diri serta memberi sumbangan terhadap keharmonian dan kemakmuran keluarga, masyarakat dan negara.”

Jelas di sini, FPK membawa matlamat bahawa mahasiswa yang ingin dilahirkan bukan sahaja mahasiswa yang cemerlang dari sudut intelek tetapi juga menyeluruh dari aspek kerohanian. Semua elemen ini membantu dalam proses pembentukan ke arah insan kamil (Marzuki et al., 2021).

Berdasarkan Falsafah Pendidikan Kebangsaan, aspek emosi dan rohani boleh dihubungkan dengan afektif iaitu mengenai perasaan dan kejiwaan (Ismail, 2015). Aspek emosi memainkan peranan penting dalam pembangunan insan sepadu. Hal ini kerana emosi mempunyai perkaitan rapat dengan hati yang menjadi sumber dalam pembinaan jiwa dan keharmonian perasaan (Salleh, 2022).

Dalam arena pendidikan, terdapat tiga domain pembelajaran yang ditekankan iaitu kognitif, afektif dan psikomotor. Domain kognitif memberi penekanan dari sudut pengetahuan manakala domain afektif dari sudut emosi dan nilai. Domain psikomotor pula menekankan dari sudut kemahiran motor dan fizikal. Domain afektif ini membentuk nilai dan moral mahasiswa bagi melahirkan sikap dan tingkah laku yang baik.

Namun begitu, nilai-nilai yang dipraktikkan di institusi pengajian tinggi (IPT) lebih menumpukan nilai dari sudut kemahiran insaniah seperti kemahiran berkomunikasi, kemahiran pemikiran kritis dan menyelesaikan masalah, kemahiran kerja berpasukan, kemahiran pembelajaran berterusan dan pengurusan maklumat, kemahiran keusahawanan, kemahiran etika moral dan profesional, dan kemahiran kepimpinan seperti mana digariskan oleh Kementerian Pendidikan Tinggi (KPT) (Zakaria & Daud, 2021). Walaubagaimanapun, kemahiran-kemahiran ini lebih berkesan jika elemen ihsan diterapkan. Hal ini kerana, pembentukan sikap mahasiswa perlulah bermula dari aspek dalaman iaitu hati. Maka, ihsan merupakan nilai utama yang membantu dalam membentuk sikap dan akhlak yang baik.

Oleh itu, ihsan adalah suatu nilai yang berbentuk kesedaran bahawa manusia perlu sentiasa amanah dalam setiap tindakan kerana merasa pengawasan daripada Allah S.W.T. Justeru itu, perbincangan di dalam penulisan ini akan mengfokuskan tentang konsep dan kepentingan ihsan dalam pembentukan afektif mahasiswa.

PEMBENTUKAN AFEKTIF

Afektif bermaksud suatu nilai (*value*) yang bersifat tersembunyi dan sentiasa berada di dalam fikiran manusia. Nilai juga berkaitan dengan pandangan seseorang terhadap sesuatu perkara seperti melihat orang yang adil dan tidak adil, orang yang baik dan orang yang jahat dan sebagainya (Mursal, 2013). Seterusnya, afektif ialah domain yang meliputi sikap, perasaan dan moral dalam membangunkan mahasiswa yang bukan sahaja bijak dalam pengetahuan bahkan mempunyai kesedaran terhadap persekitaran serta membantu dalam pembinaan akhlak baik yang selari dengan syariat Islam.

Ciri-ciri afektif boleh dilihat melalui sikap, minat, nilai, moral dan konsep diri seseorang (Alifah, 2019; Pulungan, 2013; Sukanti, 2011; Suliswiyadi, 2020). Selain itu, ciri afektif juga ialah belajar menghayati nilai dari suatu perkara yang dihadapi melalui bentuk perasaan, situasi dan mampu untuk mengeluarkan ekspresi yang sesuai mengikut keadaan (Alifah, 2019).

Selain itu, aspek rohani yang mempunyai hubungan dengan roh, jiwa dan elemen kepercayaan dan kepatuhan kepada Tuhan dapat membantu dalam pembentukan afektif mahasiswa (Salleh, 2022). Elemen rohani yang merupakan kekuatan dalaman menjadi kayu ukur bagi menentukan tahap kejayaan seseorang (Ismail, 2015). Justeru itu, afektif ini menjadi tunjang utama dalam penerapan dan penghayatan nilai bagi pembentukan akhlak dan adab dalam diri mahasiswa tersebut.

KONSEP IHSAN

Perkataan ihsan berasal daripada bahasa Arab berdasarkan kata kerja *ahsana-yuhsinu-ihsanan* yang bermaksud perbuatan baik. Definisi ihsan ini mengandungi pengertian yang luas. Secara literal, ihsan bermaksud cantik atau menjadikan sesuatu lebih baik atau indah atau kecemerlangan (Nawi & Othman, 2016; Qadir et al., 2020). Menurut Imam Raghīb al-Isfahani, seorang ahli bahasa Arab terkemuka menjelaskan bahawa ihsan bermaksud penciptaan keindahan dalam tingkah laku seseorang yang dicapai melalui keindahan dalam pengetahuan dan keindahan dalam tindakan (Al-Isfahani, 1992).

Berdasarkan sebuah hadis daripada Imam Nawawi iaitu hadis kedua dalam hadis 40 melalui riwayat hadis Abu Hurairah, Rasulullah S.A.W bersabda:

قَالَ: فَأَخْبِرْنِي عَنِ الْإِحْسَانِ قَالَ: أَنْ تَعْبُدَ اللَّهَ كَأَنَّكَ تَرَاهُ، فَإِنْ لَمْ تَكُنْ تَرَاهُ فَإِنَّهُ يَرَاكَ

Maksudnya: Beritahukan kepadaku tentang ihsan. Rasulullah S.A.W menjawab: Engkau beribadah kepada Allah seakan-akan engkau melihat-Nya, jika engkau tidak melihatnya, sesungguhnya Dia pasti melihatmu.

(Sahih Muslim: no.5)

Berdasarkan hadis di atas, pengertian ihsan ialah seseorang menyembah Allah S.W.T seolah-olah dia melihat-Nya. Jika dia tidak berupaya untuk melihat Allah S.W.T, maka sesungguhnya Allah S.W.T melihat segala amal perbuatannya. Hadis ini menghuraikan

bahawa kehadiran ihsan ini sebagai pengawasan dalam melaksanakan ibadah bahawa Allah S.W.T sentiasa melihat kita dan kita perlu sentiasa memperbaiki ibadah yang dilakukan.

Selain itu, ihsan merupakan suatu istilah yang penting di dalam Islam kerana perkataan ihsan ini diajarkan oleh Allah S.W.T melalui perantaraan malaikat Jibril bersama-sama dengan perkataan iman dan islam. Perkataan iman, islam dan ihsan ini menunjukkan bahawa ia mempunyai perkaitan dan hubungan yang kuat dalam menjadi asas kepada agama Islam. Berpandukan perbahasan ihsan menurut Sayyid Qutub (2000) dan Imam Al-Ghazali (1990), ihsan (amal kebaikan) lahir dari kesempurnaan iman dan Islam. Ihsan merupakan hasil atau impak yang diperolehi daripada keyakinan iman dan pelaksanaan Islam

Untuk mencapai iman yang sempurna, selaku mahasiswa perlulah mempunyai keyakinan yang mendalam terhadap Allah dan menjadikan iman sebagai dasar akidah dalam kehidupan. Kesempurnaan Islam boleh diperolehi dengan melaksanakan dan patuh dengan segala suruhan Allah S.W.T. Oleh itu, kebenaran iman dan pelaksanaan Islam dapat melahirkan sifat tunduk dan taat kepada Allah. Rasa kehambaan yang terbit dalam diri seorang hamba mampu mendidik jiwanya menjadi tenang dan ikhlas dalam beribadah.

Selain itu, sifat Allah yang Maha Mengawasi juga mampu dirasai oleh seorang hamba dan merasakan Allah S.W.T sentiasa mengawasi setiap perbuatan hamba-Nya. Justeru itu, manusia perlu menyedari bahawa hakikat ihsan ini membantu dalam memperbaiki dan memperbetulkan amalan serta membentuk akhlak yang mulia (Ali & Puteh, 2017).

Ihsan merupakan peringkat tertinggi dalam menentukan bukti keislaman dan keimanan seseorang serta memberi hasil dan kesan kepada kehidupan di dunia dan akhirat. Kehadiran dan kebersamaan Allah dalam setiap ibadah dan tindakan yang dilakukan dalam kehidupan merupakan salah satu hubungan dalam penyaksian kepada Allah (Pamungkas, 2019). Dengan wujudnya ihsan, segala amalan yang dilaksanakan dalam setiap aspek kehidupan dilakukan semata-mata untuk mendapat keredaan Allah. Uniknyanya, segala amalan atau ibadah yang dilaksanakan atas dasar ihsan, manfaatnya akan kembali kepada diri sendiri. Antara firman Allah S.W.T:

إِنْ أَحْسَنْتُمْ أَحْسَنْتُمْ لِأَنْفُسِكُمْ وَإِنْ أَسَأْتُمْ فَلَهَا

Maksudnya: Jika kamu berbuat kebaikan, maka faedah kebaikan yang kamu lakukan ialah untuk diri kamu dan jika kamu berbuat kejahatan maka (kesannya yang buruk) berbalik kepada diri kamu juga.

(Surah al-Isra' 17:7)

Menurut perspektif Islam, ihsan ini membentuk hati agar meyakini bahawa Allah sentiasa melihat setiap perbuatan hamba-Nya dan akhirnya membentuk tingkah laku yang lebih baik. Hati merupakan antara anggota penting dalam membantu proses pembangunan insan yang sempurna dari sudut spiritual. Dari An Nu'man bin Basyir R.A, Nabi S.A.W bersabda:

أَلَا وَإِنَّ فِي الْجَسَدِ مُضْعَةً إِذَا صَلَحَتْ صَلَحَ الْجَسَدُ كُلُّهُ ، وَإِذَا فَسَدَتْ فَسَدَ الْجَسَدُ كُلُّهُ أَلَا وَهِيَ الْقَلْبُ

Maksudnya: Ingatlah bahawa di dalam jasad itu ada segumpal daging. Jika ia baik, maka baik pula seluruh jasad. Jika ia rosak, maka rosak pula seluruh jasad. Ketahuilah bahawa ia adalah hati (jantung).

(HR Bukhari: no.52 dan Sahih Muslim: no.1599)

Elemen ihsan

Dalam mencapai ihsan, terdapat dua peringkat yang perlu dilalui iaitu *muraqabah* dan *musyahadah*. *Musyahadah* adalah beribadah seakan-akan kita melihat Allah (أَنْ تَعْبُدَ اللَّهَ كَأَنَّكَ تَرَاهُ) manakala *muraqabah* adalah merasakan bahawa Allah S.W.T Maha Memerhati setiap makhluk-Nya (فَإِنْ لَمْ تَكُنْ تَرَاهُ فَإِنَّهُ يَرَاكَ). Menurut Syeikh Soleh Ali Syeikh, ihsan ini ialah memperbaiki amalan.

Ihsan yang diharuskan dalam beribadah mempunyai dua peringkat iaitu pertama, peringkat *muraqabah*. *Muraqabah* ialah seseorang melakukan ibadah dan merasakan bahawa Allah sentiasa memerhati dan mengawasi setiap tindakan yang dilakukan (Ali, 2010). Ini berdasarkan sabda Nabi S.A.W:

فَإِنْ لَمْ تَكُنْ تَرَاهُ فَإِنَّهُ يَرَاكَ

(jika kamu tidak melihat-Nya maka sesungguhnya Dia melihatmu)

Peringkat *muraqabah* ini merupakan peringkat yang dimiliki oleh kebanyakan manusia. Hal ini kerana apabila seseorang tidak mampu untuk menyaksikan sifat-sifat Allah maka dia yakin bahawa Allah S.W.T melihatnya. Sebagai contoh, apabila seseorang menunaikan solat dan merasakan bahawa Allah S.W.T sedang memerhatikannya lalu dia memperbaiki solatnya dengan lebih baik. Sebagaimana firman Allah S.W.T dalam surah Yunus, ayat 61:

وَمَا تَكُونُ فِي شَأْنٍ وَمَا تَتْلُوا مِنْهُ مِنْ قُرْآنٍ وَلَا تَعْمَلُونَ مِنْ عَمَلٍ إِلَّا كُنَّا عَلَيْكُمْ شُهُودًا إِذْ تُبَيِّضُونَ فِيهِ

Maksudnya: Dan tidaklah engkau (wahai Muhammad) dalam menjalankan sesuatu urusan, dan tidaklah engkau dalam membaca sesuatu surah atau sesuatu ayat dari Al-Quran dan tidaklah kamu (wahai umat manusia) dalam mengerjakan sesuatu amal usaha, melainkan adalah Kami menjadi saksi terhadap kamu, ketika kamu mengerjakannya.

Menurut Ibnu Ajibat bahawa dalam kalangan manusia ini ada tiga jenis *muraqabah* iaitu: *muraqabah al-zawahir*, *muraqabah al-qulub* dan *muraqabah al-sara'ir* (Ajibat, 2002) (Jasmi, 2017).

- i) Pengawasan Zahir / *Muraqabah al-zawahir*
Kepercayaan seseorang bahawa Allah S.W.T melihatnya dan Dia sentiasa ada di setiap tempat. Hasil daripada *muraqabah* ini menyebabkan hamba itu berasa malu kepada-Nya untuk melakukan perkara keburukan di hadapan Allah S.W.T.
- ii) Pengawasan Hati / *Muraqabah al-qulub*
Kepastian seseorang bahawa Allah berada di dalam hatinya maka dia malu untuk melakukan perkara yang tidak berfaedah atau berfikir perkara yang tidak bermanfaat untuk dirinya. Sekiranya dia terfikir atau melakukan keburukan, maka dia akan beristighfar dan bertaubat kepada Allah.
- iii) Pengawasan Rohani / *Muraqabah al-sara'ir*
Tersingkap hijab dari rohnya sehingga rohnya boleh melihat Allah S.W.T sangat dekat dengannya berbanding apa pun di dunia ini. Oleh itu, dia malu untuk melakukan perkara yang tidak berfaedah dan tidak wajar. Jika dia melakukannya, maka dia akan segera beristighfar dan memohon taubat kepada Allah.

Peringkat yang kedua ialah *musyahadah*. Peringkat ini merupakan peringkat yang lebih tinggi berbanding yang pertama. *Musyahadah* bermaksud penyaksian seseorang kepada sifat-sifat Allah S.W.T dan menghubungkan setiap amalan atau ibadahnya dengan sifat-sifat tersebut. Ini berkaitan dengan hadis Jibril yang disabdakan oleh Nabi S.A.W:

أَنْ تَعْبُدَ اللَّهَ كَأَنَّكَ تَرَاهُ

(Engkau beribadah kepada Allah S.W.T seakan-akan engkau melihat-Nya)

Hadis ini menekankan bahawa bukan dengan melihat zat Allah S.W.T tetapi melihat sifat-sifat-Nya iaitu dengan memerhatikan kesan nama-nama Allah S.W.T dan sifat-sifat-Nya pada makhluk-Nya. Apabila seseorang memiliki ilmu dan keyakinan kepada sifat-sifat Allah S.W.T maka dia akan mengembalikan semua tanda-tanda kekuasaan Allah kepada nama-nama dan sifat-sifat-Nya. Oleh itu, peringkat *musyadah* ini merupakan peringkat yang tertinggi dalam mencapai ihsan (Ali, 2010; Inayah, 2015).

Ciri-ciri Ihsan

Orang yang memiliki ciri-ciri ihsan digelar sebagai *muhsin*. Antara ciri ihsan seperti berikut (Rafiq, 2020) :

- i. Selalu mengingati Allah S.W.T
Ihsan merupakan kesedaran bahawa Allah sentiasa bersama. Istilah lain dari kesedaran ini adalah selalu berzikir kepada Allah di mana-mana. Keadaan ini menjadi faktor utama membentuk jiwa seseorang menjadi tenang dan tenteram.
- ii. Mudah untuk melakukan kebaikan
Keadaan jiwa yang tenang dan tenteram akan dapat membentuk perilaku dan tindakan yang baik. Manusia akan berasa ringan dalam melakukan perbuatan-perbuatan baik dan bermanfaat, baik bagi dirinya sendiri atau bermanfaat kepada orang lain.
- iii. Meninggalkan hal-hal yang tidak bermanfaat.
Seorang muhsin adalah mereka mampu meninggalkan sesuatu yang tidak ada manfaatnya. Perbuatan yang dilakukan sentiasa mengandungi manfaat dan tujuan yang mulia. Tidak ada satupun perbuatannya yang tidak bermanfaat bagi dirinya sendiri mahupun orang-orang di sekitarnya.
- iv. Istiqamah atau berterusan
Istiqamah merupakan sikap yang tidak boleh dipisahkan dari ihsan. Ketiga ciri di atas belum cukup membuktikan bahawa seseorang itu menjadi muhsin jika ketiga-tiga ciri ini tidak dilakukan secara terus menerus atau istiqamah. Istiqamah merupakan syarat agar amalan yang dilakukan itu mencapai hasil yang dikehendaki.

KEPENTINGAN IHSAN DALAM PEMBENTUKAN AFEKTIF MAHASISWA

Bagi membentuk afektif mahasiswa, nilai ihsan perlulah diterapkan dalam melahirkan mahasiswa yang holistik. Kepentingan ihsan ini dapat membantu dalam menghadirkan kesedaran bertuhan dalam keperibadian mahasiswa, menjadi kayu ukur dalam menentukan kualiti ibadah atau pekerjaan, pembentukan sikap dan akhlak mulia dan berbuat baik kepada sesama manusia.

Rajah 1. Kepentingan ihsan dalam pembentukan afektif mahasiswa

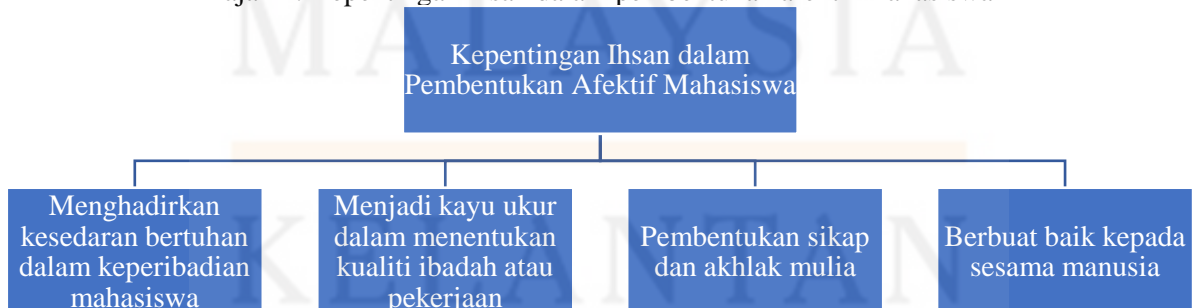

Menghadirkan kesedaran bertuhan dalam keperibadian mahasiswa.

Rasulullah S.A.W bersabda:

قَالَ: فَأَخْبِرْنِي عَنِ الْإِحْسَانِ قَالَ: أَنْ تَعْبُدَ اللَّهَ كَأَنَّكَ تَرَاهُ، فَإِنْ لَمْ تُكُنْ تَرَاهُ فَإِنَّهُ يَرَاكَ

Maksudnya: Beritahukan kepadaku tentang ihsan. Rasulullah S.A.W menjawab: Enngkau beribadah kepada Allah seakan-akan engkau melihat-Nya, jika engkau tidak melihat-Nya sesungguhnya Dia pasti melihatmu.

(Sahih Muslim: no.5)

Setiap amalan yang dilakukan perlulah disertai dengan ihsan dalam diri. Ihsan ini memberikan kesedaran bahawa kita ada Allah yang Maha Melihat setiap gerak geri dan tingkah laku kita. Ilmu dan kesedaran tentang ihsan memandu mahasiswa dalam mengetahui tentang manfaat dan tujuan apabila melakukan sesuatu perbuatan. Setiap amalan kebaikan yang dilakukan manusia itu merupakan ihsan dan ihsan itu bersumberkan daripada tauhid dan keimanan kepada Allah S.W.T. (Qutub, 2000).

Dalam melakukan kebaikan, manusia menyedari tentang pahala dan ganjaran yang akan diperolehi. Kebaikan yang dilakukan itu semata-mata kerana mentaati perintah Allah S.W.T. Manusia yang memiliki ihsan akan meninggalkan keburukan atau kemaksiatan kerana mengetahui dosa dan kesan yang akan diperolehi daripada perbuatan itu (Ali & Puteh, 2017).

Hakikatnya, martabat ihsan itu lebih tinggi berbanding iman. Hal ini kerana ihsan itu memperbaiki dan meningkatkan keimanan seseorang ke arah yang lebih baik. Dengan hadirnya ihsan membuktikan bahawa Allah S.W.T itu sentiasa wujud dan melihat setiap tingkah laku hamba-Nya (Zakaria & Azahari, 2019).

Sebagai hamba Allah S.W.T, kita wajib menghadirkan rasa ihsan dalam beribadah seperti menunaikan solat dan berpuasa dengan cara yang betul mengikut syarat, rukun, sunnah serta adab-adab yang sempurna. Kenikmatan beribadah itu tidak dapat dirasai apabila kita tidak merasakan diri kita diawasi oleh Allah S.W.T. Pelaksanaan ibadah itu juga menjadi tidak sempurna tanpa kehadiran ihsan dalam diri.

Kehadiran ihsan juga dapat melahirkan kepercayaan dan tanggapan bahawa segala suatu perkara atau usaha yang dilakukan hakikatnya bergantung pada ketentuan Allah S.W.T. Apabila manusia mengalami kekecewaan atau kerugian, mereka tidak akan bersedih atau berputus asa. Mereka akan lebih berusaha kerana yakin dengan rezeki dan ketentuan yang ditetapkan untuk hamba-Nya (Ali & Puteh, 2017). Oleh itu, ihsan ini dapat melahirkan mahasiswa yang sentiasa ikhlas beribadah atau bekerja kerana ingin mendapatkan keredaan Allah S.W.T.

Menjadi kayu ukur dalam menentukan kualiti ibadah atau pekerjaan

Allah S.W.T berfirman:

إِنَّ الَّذِينَ ءَامَنُوا وَعَمِلُوا الصَّالِحَاتِ إِنَّا لَا نُضِيعُ أَجْرَ مَنْ أَحْسَنَ عَمَلًا

Maksudnya: Sebenarnya orang-orang yang beriman dan beramal soleh sudah tetap Kami tidak akan menghilangkan pahala orang-orang yang berusaha memperbaiki amalnya.

(Surah Al-Kahfi: 30)

Berdasarkan huraian ayat di atas, amal ibadah atau pekerjaan yang mempunyai unsur ihsan akan sentiasa mendapat pahala dan ganjaran oleh Allah S.W.T. Ihsan menjadi kayu ukur dalam menentukan kualiti ibadah atau pekerjaan seseorang. Dengan kewujudan ihsan, seseorang dapat mewujudkan komitmen yang tinggi dalam diri tanpa melampaui

tanggungjawab yang diberikan untuk menyempurnakan pekerjaannya. Merasai ihsan dalam diri mampu menjadikan seseorang bekerja dengan cekap dan ikhlas kerana merasakan Allah S.W.T memerhati dan menilai kualiti kerjanya.

Mahasiswa yang mempunyai ihsan akan melaksanakan tanggungjawab atau tugas mereka dengan kerelaan hati walaupun bukan menjadi kewajipannya untuk melaksanakannya. Hal ini juga dapat menutup ruang-ruang ketidaksempurnaan tanggungjawab yang diamanahkan dan itu merupakan amalan sunnah atau mustahab (pahala tambahan) (Wahab & Ismail, 2019). Seterusnya, mahasiswa yang mencapai tahap ihsan akan sangat berwaspada dalam melaksanakan tanggungjawab mereka dan akan berusaha lebih gigih untuk mencapai kecemerlangan. Setiap tanggungjawab yang digalas oleh mahasiswa diniatkan hanya kerana Allah S.W.T bukan kerana manusia.

Selain itu, ihsan mendidik mahasiswa untuk sentiasa memperbaiki mutu sesuatu amalan (Al-Ghazali, 1990). Amalan yang dilaksanakan menjadi lebih baik dan tidak sentiasa berada pada tahap yang sama. Hal ini dapat menjadi galakan kepada mahasiswa untuk sentiasa mempertingkatkan ibadah atau pekerjaan yang dilakukan kepada usaha yang lebih optimum.

Di samping itu, ihsan menjadikan seseorang untuk bekerja bersungguh-sungguh (*itqan*) dan melakukan sebaiknya. Bukan sahaja penuh kesungguhan dalam melaksanakan pekerjaan bahkan mengerahkan segala kemampuannya dalam mencapai hasil serta kualiti yang terbaik.

Pembentukan sikap dan akhlak mulia.

Pembentukan sikap dan akhlak mulia merupakan kepentingan ihsan dalam pembentukan afektif mahasiswa. Ihsan yang diterapkan dalam pembentukan akhlak menjadikan mahasiswa memiliki sikap dan tingkah laku yang baik. Penghayatan ihsan dalam pembentukan akhlak memberi kesan kepada mahasiswa sebagai pengawal kepada sikap mahasiswa itu sendiri. Kehadiran ihsan menjadi motivasi kepada mahasiswa dalam melakukan perkara-perkara kebaikan. Ihsan juga boleh mengawal mahasiswa dengan menghindari daripada perkara-perkara keburukan (Ali & Puteh, 2017).

Mahasiswa yang menjiwai ihsan akan sentiasa berakhlak mulia kerana menyedari dirinya yang sentiasa diawasi oleh Allah S.W.T. Penjiwaan terhadap ihsan ini juga mampu mewujudkan budaya saling menghormati dan toleransi seterusnya menjaga keharmonian antara mahasiswa. Selain itu, apabila mahasiswa menyedari Tuhan sentiasa mengawasi segala gerak-geri menyebabkan mereka dapat mengawal nafsunya daripada perkara-perkara yang dimurkai Allah S.W.T. Budaya negatif seperti melepak, bergosip, mengumpat, bertanggung kerja dapat dielakkan kerana rasa tanggungjawab yang tinggi terhadap amanah yang diberikan.

Berbuat baik kepada sesama manusia

Perkataan ihsan di dalam ayat Al-Quran membawa konteks yang sangat luas dan lebih memberi penumpuan kepada melakukan kebaikan dan berbuat baik kepada orang lain seperti ibu bapa, kerabat, jiran tetangga, anak yatim dan haiwan. Berdasarkan firman Allah S.W.T dalam surah An-Nahl ayat 90:

إِنَّ اللَّهَ يَأْمُرُ بِالْعَدْلِ وَالْإِحْسَانِ وَإِيتَايَ ذِي الْقُرْبَىٰ وَيَنْهَىٰ عَنِ الْفَحْشَاءِ وَالْمُنْكَرِ وَالْبَغْيِ يَعِظُكُمْ لَعَلَّكُمْ تَذَكَّرُونَ

Maksudnya: Sesungguhnya Allah menyuruh berlaku adil, dan berbuat kebaikan, serta memberi bantuan kepada kaum kerabat; dan melarang daripada melakukan perbuatan-perbuatan yang keji dan mungkar serta kezaliman. Ia mengajar kamu (dengan suruhan dan laranganNya ini), supaya kamu mengambil peringatan mematuhiNya.

Imam Al-Qurtubhi menjelaskan bahawa penurunan surah an-Nahl, ayat 90 ini diturunkan dan dibacakan kepada Ali bin Abi Talib, beliau lantas berkata bahawa “Demi Allah, sesungguhnya Dia mengutuskan Rasulullah S.A.W dengan akhlak yang mulia.” Berdasarkan ayat ini menunjukkan bahawa ihsan juga termasuk dalam lingkungan berbuat baik dan melakukan kebaikan kepada manusia (Al-Qurtubhi, 2007; Masroom et al., 2013).

Umumnya, ihsan kepada manusia adalah dengan bersikap ramah di dalam pergaulan dan ketika berkomunikasi, mengajak kepada kebaikan dan mencegah daripada keburukan atau kemungkaran, berlaku adil serta tidak menyakiti antara satu sama lain. Kepentingan ihsan ini mendidik mahasiswa agar sentiasa melakukan kebaikan kepada semua orang tanpa mengira pangkat, harta atau kerjaya yang dimiliki.

Berdasarkan ayat Al-Quran surah an-Nisa ayat 36, Allah S.W.T berfirman:

وَأَعْبُدُوا اللَّهَ وَلَا تُشْرِكُوا بِهِ شَيْئًا ۚ وَبِالْوَالِدَيْنِ إِحْسِنًا ۚ وَبِذِي الْقُرْبَىٰ وَالْيَتَامَىٰ وَالْمَسْكِينِ وَالْجَارِ ذِي الْقُرْبَىٰ
وَالْجَارِ الْجُنُبِ وَالصَّاحِبِ بِالْجَنبِ وَابْنِ السَّبِيلِ وَمَا مَلَكَتْ أَيْمَانُكُمْ ۚ إِنَّ اللَّهَ لَا يُحِبُّ مَن كَانَ مُخْتَالًا فَخُورًا

Maksudnya: Dan hendaklah kamu beribadat kepada Allah dan janganlah kamu sekutukan Dia dengan sesuatu apa jua; dan hendaklah kamu berbuat baik kepada kedua ibu bapa, dan kaum kerabat, dan anak-anak yatim, dan orang-orang miskin, dan jiran tetangga yang dekat, dan jiran tetangga yang jauh, dan rakan sejawat, dan orang musafir yang terlantar, dan juga hamba yang kamu miliki. Sesungguhnya Allah tidak suka kepada orang-orang yang sombong takbur dan membangga-banggakan diri.

Ayat ini menekankan bahawa kita perlu berbuat baik kepada ibu bapa, kaum kerabat, anak yatim, jiran tetangga dan sahabat karib. Menurut Falih Muhammad (2009), ihsan kepada ibu bapa itu dijelaskan bahawa kita perlu mentaati mereka selama mana tidak menyimpang daripada ajaran Islam, selalu membuat kebaikan serta mendoakan dan memohon keampunan bagi mereka. Manakala, ihsan kepada sahabat karib dan kaum kerabat adalah berbuat baik dan berlemah lembut kepada mereka serta melakukan perkara yang menyenangkan serta meninggalkan segala perbuatan yang menyusahkan mereka. Seterusnya, ihsan kepada anak yatim adalah menjaga harta dan hak-hak mereka seperti memberikan pendidikan, kasih sayang dan sebagainya (Ali & Puteh, 2017; Muhammad, 2009).

Ihsan juga dapat menjaga keharmonian dalam kehidupan bermasyarakat. Dengan berbuat ihsan dalam masyarakat juga dapat menimbulkan rasa cinta, persaudaraan, kasih sayang, tolong-menolong dan saling menghormati anantara satu sama lain. Oleh itu, berbuat ihsan dalam hidup bermasyarakat dapat menjamin keamanan dan kesejahteraan kepada individu, masyarakat dan negara.

PENUTUP

Ihsan dan afektif merupakan dua perkara yang saling berhubung. Pembentukan afektif mahasiswa boleh dibentuk dengan menerapkan kesedaran bertuhan agar mampu untuk membentuk sikap dan tingkah laku yang baik. Kesedaran bertuhan ini ialah asas kepada semua kebaikan yang sebenar. Hal ini selari dengan kandungan Rukun Negara dan Falsafah Pendidikan Kebangsaan yang menekankan “kepercayaan dan kepatuhan kepada Tuhan.” Setiap pihak perlu memainkan peranan dalam menerapkan pengetahuan dan pengaplikasian tentang ihsan ini kepada mahasiswa. Kehadiran ihsan ini dapat mengawal tingkah laku dan sikap mahasiswa supaya sentiasa berhati-hati dalam setiap tindakan yang dilakukan sama ada di kala bersendirian atau di tengah ramai. Kesan daripada kehadiran ihsan ini dapat menjadikan mahasiswa sentiasa melakukan kebaikan dengan ikhlas dan sedar serta berusaha memberikan yang terbaik dalam kehidupan mereka. Dengan penghayatan sifat ihsan ini maka terbentuklah

mahasiswa holistik yang merasai kesejahteraan dalam dirinya dan membawa kesejahteraan kepada dunia.

RUJUKAN

- Al-Quran Al-Karim & Terjemahan. Al-Quran Darul Iman. Kuala Lumpur: Pustaka Darul Iman Sdn. Bhd
- Ajibat, A. M. I. (2002). *Al-Bahr al-Madid fi Tafsir al-Quran Al-Majid* (Ahmad Abdu). Dar Al-Kutub Al-Ilmiyyah.
- Al-Ghazali, M. H. (1990). *Al-Janib Al-Athifi Min Al-Islam, Bahts Fi Al-Khulq Wa Al Suluk Wa Al-Tashawwuf*. Dar Al- Da'wah.
- Al-Isfahani, R. (1992). *Al-Mufradat fi Gharib al-Quran*. Dar al-Elm.
- Al-Qurtubhi, I. (2007). *Tafsir Al-Qurthubi*. Pustaka Azzam.
- Ali, N. A. H. M., & Puteh, A. (2017). Penghayatan Ihsan Sebagai Medium Pengukuhan Budaya Kerja Berintegriti. *Fikiran Masyarakat*, 5(3), 112–118.
- Ali, S. A. A. M. I. (2010). *Syarah Arbain Nawawi* (A. M. M. Rifaie (ed.); 1st ed.). Darul Asimah.
- Alifah, F. N. (2019). Pengembangan Strategi Pembelajaran Afektif. *Tadrib: Jurnal Pendidikan Agama Islam*, 5(1), 68–86. <https://doi.org/10.19109/tadrib.v5i1.2587>
- Cahyono, H. (2019). Peran Mahasiswa di Masyarakat. *Jurnal Pengabdian Masyarakat Setiabudhi*, 1(1), 32–43. <https://doi.org/10.4000/adlfi.2398>
- Darmanto, S. (2019). *Konsep Ihsan dalam Tafsir Al-Ibriz* [Institut Agama Islam Negeri Tulungagung]. <http://repo.uinsatu.ac.id/13523/>
- Inayah, M. (2015). *Konsep Ihsan Sebagai Pendidikan Karakter Dalam Pemikiran Sachiko Murata dan William C Chittick*. Universitas Islam Negeri Maulana Malik Ibrahim Malang.
- Ismail, S. (2015). Pembangunan Insan Dalam Falsafah Pendidikan Kebangsaan. *Journal of Human Capital Development (JHCD)*, 8(2), 83–100.
- Jasmi, K. A. (2017). *Ensiklopedia Pendidikan Islam* (Kamarul Azmi Jasmi (ed.); 2nd ed.). Universiti Teknologi Malaysia.
- Marzuki, M., Abd Rahman, M. H., Kaspin, K. G., Jamal, M. B., Mohd Nor, N. M., & Othman, I. W. (2021). Universiti Sebagai Medan Pembentukan Kecemerlangan Akhlak Mahasiswa. *International Journal of Education, Psychology and Counseling*, 6(39), 90–100. <https://doi.org/10.35631/ijepc.639005>
- Masroom, M. N., Muhammad, S. N., & Rahman, S. A. P. (2013). Iman, Islam dan Ihsan: Kaitannya dengan Kesehatan Jiwa. *Seminar Pendidikan & Penyelidikan Islam, Januari*, 582–590.
- Muhammad, F. (2009). *Meraih Puncak Ihsan. Cet 1. Tjmh. Darwis*. Darussunah.
- Mursal. (2013). Pendidikan Afektif dalam Perspektif Hassan Langgulung. *Al-Fikra: Jurnal Ilmiah Keislaman*, 12(1), 53–69.
- Nawi, N. H. M., & Othman, B. (2016). Personaliti: Konsep, Kunci dan Sumber Menurut Perspektif Islam. *International Journal of Islamic and Civilization Studies*, 3(3), 15–24. [www.http://jurnalumran.utm.my/index.php/umran](http://jurnalumran.utm.my/index.php/umran)
- Pamungkas, D. D. (2019). *Konsep Ihsan dalam Perspektif Tasawuf*. UNiversitas Negeri Raden Intan Lampung.
- Pulungan, M. Y. (2013). Pembelajaran Ranah Afektif Antara Harapan dan Kenyataan. *Jurnal Darul 'Ilmi*, 01(2), 45–76.
- Qadir, J., Raquib, A., & Saeed Ahmed, H. (2020). Chapter 12: Spiritual Excellence (Ihsān) for Professionals: A Ḥadīth-Based Perspective. In *Handbook of Ethics of Islamic Economics and Finance* (pp. 217–237). De Gruyter.

- <https://doi.org/10.1515/9783110593419-012>
- Qutub, S. (2000). *Tafsir Fil Zilalil Quran, Di Bawah Bayangan Al-Quran*. Tjmh. YusoffZaky Haji Yacob. Pustaka Aman Press Sdn. Bhd.
- Rafiq, M. F. (2020). Peran Ihsan Dalam Pembentukan Akhlak Manusia. *Jurnal Keislaman*.
- Salleh, M. J. (2022). Falsafah Pendidikan Kebangsaan Paradigma J.E.R.I.S.A.H Membina Insan Sejahtera Bertaqwa: Perspektif Kepimpinan Pendidikan Dan Guru-Guru. *Jurnal Dunia Pendidikan*, 4(1), 197–215. <https://doi.org/10.55057/jdpd.2022.4.1.15>
- Sukanti. (2011). Penilaian Afektif dalam Pembelajaran Akuntansi. *Jurnal Pendidikan Akutansi Indonesia*, IX(1), 74–82.
- Suliswiyadi. (2020). Hierarki Ranah Pembelajaran Afektif Pendidikan Agama Islam dalam Perspektif Taksonomi Qur’ani. *Jurnal Tarbiyatuna*, 11(1), 61–76. <https://doi.org/10.31603/tarbiyatuna.v11i1.3451>
- Wahab, M. A., & Ismail, Y. (2019). Mas’uliyya and Ihsan as High-Performance Work Values in Islam. *International Journal of Economis, Management and Accounting*, 27(1), 187–212.
- Zakaria, N. D., & Azahari, R. (2019). Menghayati Nilai Iman, Islam dan Ihsan dalam Mendepani Cabaran Kontemporari. *Ar-Ra’iq*, 5(1), 20–74.
- Zakaria, S. K., & Daud, M. N. (2021). Penjanaan Kemahiran Insaniah Melalui Gaya Pembelajaran dan Kecerdasan Pelbagai. *Jurnal Dunia Pendidikan*, 3(4), 65–76. <https://doi.org/10.55057/jdpd.2021.3.4.6>

Adakah Sama Atau Berbeza? Satu Perkongsian Penggunaan Dialek Melayu Kelantan dan Dialek Melayu Patani dalam Kalangan Pelajar Jurusan Bahasa Melayu di Universiti Yala Rajabhat, Thailand dalam Kursus Pengacaraan Majlis Tempatan

Khuzaiton Zakaria
Universiti Malaysia Kelantan
khuzaiton@umk.edu.my

Nurul Huda Sa'dama
Yala Rajabhat University, Thailand
nurhuda.s@yru.ac.th

ABSTRAK

Dialek dipertuturkan dari satu generasi ke satu generasi dalam sesuatu daerah yang berbeza daripada bahasa standard. Dialek Melayu Kelantan dipertuturkan oleh masyarakat Kelantan manakala dialek Melayu Patani dipertuturkan oleh masyarakat Melayu di tiga wilayah selatan Thai iaitu Narawathiwat, Yala dan Patani. Dialek Melayu Patani masih digunakan oleh orang-orang Melayu di tiga wilayah tersebut walaupun bahasa Thai menjadi bahasa harian yang digunakan apabila mereka berkomunikasi. Kertas kerja ini adalah berdasarkan pengalaman pengkaji mengajar kursus Pengacaraan Majlis Tempatan kepada pelajar Jurusan Bahasa Melayu di Yala Rajabhat University, Thailand. Kursus ini telah diadakan dalam bahasa Melayu selama 6 minggu dengan kerjasama pensyarah bahasa Melayu dari universiti tersebut. Semasa kursus berlangsung, pengkaji mendapati banyak perkataan dalam dialek Melayu Patani yang digunakan oleh pelajar Jurusan Bahasa Melayu di dalam kelas mempunyai persamaan dengan dialek Melayu Kelantan. Namun, terdapat juga perbezaan dari segi sebutan tetapi mempunyai maksud yang sama. Kertas kerja ini membentangkan persamaan dan perbezaan 100 perkataan yang terdiri daripada kata nama, kata kerja, kata adjektif dan kata penguat dalam dialek Melayu Patani dan dialek Melayu Kelantan yang digunakan oleh pelajar dalam kursus Pengacaraan Majlis Tempatan.

Kata kunci : *bahasa Melayu; Dialek Melayu Kelantan; Dialek Melayu Patani ; pelajar Jurusan Bahasa Melayu; Kursus Pengacaraan Majlis Tempatan*

PENGENALAN

Dialek adalah kelainan bahasa yang digunakan sebagai bahasa pertuturan harian oleh penutur di sesebuah tempat atau kawasan yang mempunyai kesantunan bahasa dan keunikannya tersendiri. Penggunaan sesuatu dialek itu ditentukan oleh kedudukan geografi sesuatu kawasan atau kelompok sosial.

Dialek Melayu Kelantan bukan sahaja dituturkan oleh penutur jati di negeri Kelantan, malah turut dituturkan juga oleh penduduk yang bersempadan dengan negeri Kelantan, iaitu Terengganu, Pahang dan Perak. Manakala, dialek Melayu Patani dituturkan oleh penduduk di Sungai Golok, Narathiwat, Yala dan Patani sebagai bahasa pertuturan harian yang sering kali dicampur dengan bahasa Thai. Kedua-dua dialek ini mempunyai kesantunan bahasa, keindahan bahasa serta keunikan bahasa tersendiri yang dapat dibanggakan oleh penuturnya kerana dialek juga melambangkan cara hidup dan budaya di sesebuah kawasan dan masyarakat penuturnya.

Pengamatan pengkaji semasa mengajar kursus Pengacaraan Majlis Tempatan selama enam minggu kepada pelajar Jurusan Bahasa Melayu di Yala Rajabhat University (YRU), Thailand mendapati pelajar-pelajar menggunakan dialek Melayu Patani yang bercampur dengan bahasa Thai semasa berkomunikasi sesama mereka di dalam kelas. Pengkaji juga mendapati dialek Melayu Patani mempunyai persamaan dari segi maksud atau makna yang sama dengan dialek Melayu Kelantan cuma berbeza sedikit dari segi intonasi ataupun nada sebutan. Antaranya, perkataan gaduh yang bermaksud cepat dalam ayat “baco ayak tu jange dok gaduh. Bia ayak tu jelah”. Ayat dalam dialek Melayu Patani itu bermaksud “Baca ayat itu jangan cepat. Biar ayat itu jelas”.

Kursus Pengacaraan Majlis Tempatan ialah kursus yang mempersiapkan diri pelajar untuk menjadi seorang pengacara majlis dengan memberi pengetahuan dan kefahaman mengenai teori dan amalan protokol, etiket sosial dan tatacara pengacaraan majlis agar menjadi pengacara majlis yang berkebolehan, tidak kekok untuk tampil ke hadapan serta mampu berkomunikasi dengan baik, seterusnya memastikan majlis berjalan lancar. Kursus Pengacaraan Majlis Tempatan ini diadakan dalam bahasa Melayu secara dalam talian selama enam minggu kepada pelajar Jurusan Bahasa Melayu di Yala Rajabhat University, Thailand. Kursus ini diadakan selama dua jam pada hari Rabu setiap minggu bermula pada pukul 10.00 pagi dan berakhir pada pukul 12.00 tengah hari. Kursus ini memberi pendedahan dan peluang kepada pelajar untuk menjadi pengacara majlis dalam majlis rasmi atau tidak rasmi dengan memberi tunjuk ajar dalam melaksanakan tugas dengan mengikut protokol majlis rasmi atau tidak rasmi.

Tugas menjadi pengacara majlis selalu dianggap mudah. Namun begitu, sebenarnya tugas sebagai seorang pengacara bukanlah mudah seperti yang kita sangkakan dan jangkakan kerana kelancaran sesebuah majlis itu bergantung kepada pengacara majlis itu sendiri. Pengacara atau juruacara mestilah seorang yang fasih dalam berbahasa dan berkomunikasi serta mampu mengendalikan perjalanan acara sesuatu majlis. Pengacara majlis berperanan memudahkan kelangsungan majlis mengikut atur cara yang ditetapkan oleh penganjur. Justeru, Kursus Pengacaraan Majlis Tempatan diadakan kepada pelajar-pelajar tahun dua (2) Jurusan Bahasa Melayu di YRU sebagai pendedahan bagi membolehkan para pelajar menjadi pengacara majlis yang berani, yakin dan mampu mengendalikan sesuatu majlis dengan menggunakan bahasa Melayu yang betul dan menarik.

Kajian ini adalah untuk membuat perbandingan sama ada wujudnya persamaan atau perbezaan antara dialek Melayu Patani dan dialek Melayu Kelantan berdasarkan pengamatan dan pengalaman pengkaji semasa mengendalikan kursus tersebut. Pengkaji mendapati banyak perkataan dalam dialek Melayu Patani yang digunakan oleh pelajar Jurusan Bahasa Melayu semasa mereka berkomunikasi sesama mereka. Perkataan-perkataan itu meliputi kata nama, kata kerja, kata adjektif, dan kata penguat yang mempunyai persamaan dengan dialek Melayu Kelantan cuma berbeza dari segi sebutan dan intonasi namun mempunyai maksud yang sama. Kajian ini menyenaraikan 100 perkataan yang mempunyai persamaan dan perbezaan dalam kata nama, kata kerja, kata adjektif dan kata penguat yang digunakan dalam pertuturan pelajar Jurusan Bahasa Melayu di YRU seperti perkataan [tɔhoʔ] “buang”, [pɛkoŋ] “melontar” di samping menyenaraikan perkataan yang sudah jarang digunakan dalam dialek Melayu Kelantan tetapi masih digunakan oleh penutur dalam dialek Melayu Patani.

KAJIAN LITERATUR

Bahasa sangat penting bagi manusia. Bahasa ialah alat komunikasi yang paling efektif dalam memastikan proses komunikasi berjalan lancar antara penutur dan pendengar. Pastinya komunikasi tidak dapat dijalankan sekiranya tiada bahasa (Saidatul Nornis, 2012). Tambahan pula, bahasa mempunyai bentuk-bentuk kata yang mempunyai makna dan tersusun mengikut aturan tatabahasa yang dimiliki oleh setiap bahasa dalam masyarakat tertentu contohnya bahasa Melayu dan masyarakat pula hanya dapat disatukan secara efisien melalui bahasa. Terdapat banyak kajian mengenai perbezaan variasi bahasa dari segi dialek geografi bahasa Melayu (BM) telah dijalankan disebabkan keunikan tertentu berdasarkan kawasan di Malaysia (Nur Adibah Hasan & Sharifah Raihan Syed Jaafar, 2017). Justeru, kajian berkaitan dialek Melayu menjadi tumpuan untuk dilaksanakan oleh para pengkaji bahasa.

Kelantan yang terletak di pantai timur Semenanjung Malaysia juga dikenali sebagai negeri Cik Siti Wan Kembang menggunakan dialek yang tersendiri iaitu dialek Melayu Kelantan dalam kalangan penuturnya. Kajian Sturrock A.J. (1912) bertajuk *Some Notes on Kelantan Dialects and Some Comparison with Dialects of Perak and Central Pahang* menjelaskan dialek Melayu Kelantan mempunyai keistimewaan yang tersendiri berbanding dengan dialek-dialek Melayu yang lain. Hal ini demikian kerana, beliau telah mengkaji dialek Melayu Pahang dan dialek Melayu Perak dengan dialek Melayu Kelantan dan hasil kajian jelas menunjukkan terdapat perbezaan dari segi kosa kata dan kata ganti nama diri. Hubungan yang sangat kuat jelas terbukti antara dialek Melayu Pahang dengan dialek Melayu Perak dan beliau mendapati dialek Melayu Kelantan mempunyai lebih kuat hubungan dengan dialek Melayu Patani.

Abdul Hamid Mahmood (1994), menyatakan bahawa dialek Melayu Kelantan adalah salah satu daripada dialek-dialek Melayu yang dituturkan oleh penutur-penutur natif yang sememangnya berasal dari Kelantan dan yang menduduki negeri Kelantan.

C.C. Brown seorang pengkaji luar telah menulis sebuah buku yang bertajuk *Studies in Country Malay*. Buku ini ialah kajian beliau tentang dialek Melayu Kelantan di samping kajian tentang dialek Melayu Terengganu dan dialek Melayu Perak. Beliau menyatakan terdapat sedikit persamaan antara dialek Melayu Kelantan dengan dialek Melayu Terengganu berdasarkan buku yang dihasilkan.

Asmah (1985) menganggap dialek adalah kelainan bahasa yang bukan merupakan bahasa standard dan tidak menggolongkan dialek Melayu Patani sebagai salah satu daripada dialek-dialek Melayu Semenanjung. Halliday (1968) menyatakan variasi bahasa dapat dilihat melalui dua aspek, iaitu pengguna atau penutur dan penggunaan. Secara umumnya, dialek merupakan variasi bahasa yang dituturkan oleh sekumpulan penutur dalam satu-satu komuniti bahasa di sesebuah kawasan dan tempat. Jika sekiranya ada perbezaan dialek di kawasan-kawasan tersebut, namun kadar untuk memahami terhadap semua dialek adalah tinggi. Malah penyebaran semua dialek masih menunjukkan kesinambungan yang ketara walaupun sebutannya berbeza (Siti Noraini Hamzah & Nor Hashimah Jalaludin, 2018).

Ajid Che Kob (1985), dalam bukunya yang bertajuk *Dialek Geografi Pasir Mas* telah melakukan kajian dialek Melayu Kelantan dengan memberi tumpuan kepada perbandingan aspek fonologi dan leksikal sahaja di sepuluh buah daerah di Pasir Mas. Kajian yang dijalankan ini tidak meliputi aspek morfologi, sintaksis, dan semantik. Perbandingan aspek fonologi ini dikaji dari segi sebutan vokal dan konsonan sahaja serta penyebaran kata-kata dari segi leksikal

yang bertujuan untuk melihat kesejajaran dari aspek fonologi dan leksikal dialek Melayu Kelantan di daerah Pasir Mas, Kelantan.

Masyarakat Melayu merupakan masyarakat peribumi yang tinggal di tiga wilayah sempadan selatan Thai dan masyarakat ini adalah golongan penduduk terbesar di wilayah sempadan selatan Thai. Masyarakat Melayu ini mempunyai sosiobudaya tersendiri yang meliputi bahasa pertuturan dan amalan budaya dalam kehidupan bermasyarakat. Mereka mempunyai bahasa ibunda iaitu dialek Melayu Patani yang serumpun dengan bahasa Melayu, mengamalkan budaya Melayu dan menjalankan kehidupan harian yang hampir sama dengan masyarakat Melayu di Malaysia.

Berdasarkan latar belakang persejaraan masyarakat Melayu di tiga wilayah sempadan selatan Thai, dibuktikan penduduk masyarakat ini ialah orang Melayu yang menggunakan dialek Melayu Patani sebagai bahasa pertama dan bahasa perantaraan dalam komunikasi harian atau semasa berinteraksi dalam masyarakat. Sejarah juga membuktikan sejak zaman dahulu hingga sekarang, dialek Melayu Patani digunakan oleh masyarakat dalam berbagai-bagai latar tempat dan latar waktu.

Dialek Melayu Patani digunakan secara meluas dalam pelbagai situasi dan keadaan peristiwa komunikasi seperti dalam situasi formal, antaranya ketika berkhutbah, berceramah, majlis ilmiah, majlis keagamaan dan majlis keraian. Dialek Melayu Patani sering kali digunakan dalam situasi tidak formal, seperti dalam komunikasi harian (Kamaruddin, 2019). Bahkan terdapat siaran Radio Yala Sovotho 95.0 megahertz yakni siaran radio yang menjadikan dialek Melayu Patani sebagai bahasa komunikasi dan bahasa untuk menyampaikan berita dan maklumat kepada para pendengar. Siaran radio ini bersiaran pada setiap hari dengan juruhebah yang berkomunikasi dalam dialek Melayu Patani sebagai bahasa pertuturan. Namun begitu, faktor kemasyarakatan dan politik tempatan merupakan faktor yang membezakan kedua-dua masyarakat iaitu masyarakat Melayu di Kelantan dan masyarakat Melayu di wilayah sempadan selatan Thai.

Collins (1986) dalam buku *Antologi Kajian Dialek Melayu* telah menghuraikan secara ringkas tentang dialek Melayu yang digunakan di Sungai Pahang. Beliau juga turut mengkaji tentang vokal sengau dialek Melayu Kelantan. Berdasarkan penelitian yang dibuat, beliau menyatakan corak pertuturan orang-orang Melayu di Kelantan dan Patani menunjukkan banyak persamaan dan mempunyai ikatan yang sangat kuat.

Tuntasnya, berdasarkan kajian lepas yang telah diteroka oleh pengkaji tentang dialek Melayu yang dituturkan oleh penutur atau masyarakat di sesebuah tempat adalah wujudnya persamaan dan perbezaan dalam variasi dialek yang melibatkan dua aspek iaitu pengguna dan penggunaan dialek Melayu sama ada dialek Melayu Kelantan atau dialek Melayu Patani. Persamaan dan perbezaan yang wujud dalam kedua-dua dialek ini melambangkan keunikan dan keindahan bahasa atau dialek itu sendiri yang merangkumi budaya dan bangsa Melayu walaupun terpisah lokaliti dek persempadanan negara namun, keindahan dialek ini masih tetap utuh digunakan dalam kehidupan seharian dan ia melambangkan jati diri orang Melayu walau di negara mana mereka berada di dunia ini.

METODOLOGI

Kajian ini dijalankan dengan menggunakan metodologi kualitatif iaitu kaedah temu bual, pemerhatian dan catatan serta perbualan dengan pelajar-pelajar Jurusan Bahasa Melayu tahun

2, di Yala Rajabhat University, Thailand semasa kelas Pengacaraan Majlis Tempatan diadakan selama dua jam pada setiap minggu.

Responden bagi sesi temu bual adalah 17 orang pelajar dan seorang pensyarah Jurusan Bahasa Melayu dari Yala Rajabhat University, Thailand. Temu bual diadakan selepas kelas Pengacaraan Majlis Tempatan dengan cara bersahaja sambil berbual-bual santai. Perbualan dengan pelajar-pelajar selalu diadakan selepas kelas bagi mengeratkan hubungan silaturahim walaupun secara dalam talian. Pengkaji mencatatkan perkataan-perkataan yang pelajar gunakan semasa mereka berinteraksi sesama mereka di dalam kelas. Perkataan yang mereka gunakan dalam dialek Melayu Patani itu ada persamaan dan perbezaan makna dengan Dialek Melayu Kelantan tetapi secara sebutannya sedikit berbeza.

Pengkaji juga mengamati percakapan penyampai radio dan masyarakat Melayu yang menggunakan dialek Melayu Patani melalui panggilan telefon yang dibuat dalam siaran Radio Sovotho Yala dalam ruangan Bahasa Melayu Tempatan 24 Jam. Siaran ini ke udara selama 24 jam dalam dialek Melayu Patani dan boleh didengari di Kelantan menerusi frekuensi 95.0 megahertz. Manakala siaran Radio Kelantan FM menerusi rancangan Apa Khabar Orang Kampung (AKOK) bermula dari jam 2.00 petang hingga 5.59 petang pada setiap hari. Penyampai menggunakan dialek Melayu Kelantan semasa mengendalikan rancangan tersebut. Justeru, pengkaji mencatat dan menyenaraikan perkataan-perkataan yang mempunyai persamaan dan perbezaan makna antara kedua-dua dialek ini dengan cara sebutan dan intonasi yang berbeza. Di samping itu, pengkaji juga merekod perkataan yang jarang digunakan sekarang oleh penutur dialek Melayu Kelantan tetapi masih digunakan oleh penutur dialek Melayu Patani. Sebanyak 100 perkataan yang dicatat dan disenaraikan mengikut golongan kata iaitu kata nama, kata adjektif, kata kerja dan kata penguat bagi tujuan kajian ini. Dapatan kajian ini dikumpul dan didokumenkan dalam bentuk jadual dan dibincangkan secara deskriptif.

HASIL KAJIAN

Berdasarkan kajian yang dijalankan, pengkaji mendapati wujudnya persamaan dan perbezaan yang tidak begitu ketara dari segi sebutan bagi perkataan yang telah disenaraikan oleh pengkaji. Namun begitu, pengkaji mendapati ada perkataan yang jarang digunakan oleh masyarakat Melayu di Kelantan tetapi masih digunakan oleh masyarakat Melayu di wilayah selatan Thai dalam pertuturan harian mereka. Dapatan kajian dapat dilihat dalam Jadual 1 bagi persamaan dan perbezaan kata nama, Jadual 2 bagi persamaan dan perbezaan kata adjektif, Jadual 3 persamaan dan perbezaan kata kerja, Jadual 4 persamaan dan perbezaan kata penguat dan Jadual 5 perkataan yang jarang digunakan oleh masyarakat di Kelantan tetapi masih digunakan oleh masyarakat di selatan Thai.

Beberapa Ciri Sebutan Dialek Melayu Kelantan dan Dialek Melayu Patani

Pengkaji mendapati terdapat beberapa ciri sebutan dialek Melayu Kelantan dan dialek Melayu Patani yang ketara iaitu perubahan bunyi konsonan tertentu yang berlaku pada kedudukan tertentu, antaranya ialah:

Suku kata tertutup dalam bahasa Melayu baku yang berakhir dengan bunyi [an], [am] dan [ang] akan berubah menjadi suku kata akhir terbuka [ɛ] dalam dialek Melayu Kelantan dan dialek Melayu Patani. Contohnya, hutan [hu.tɛ], hitam [hi.tɛ] dan arang [a.ɣɛ].

Suku kata tertutup yang berakhir dengan [ar] dalam bahasa Melayu baku akan berubah menjadi suku kata terbuka [a] dalam dialek Melayu Kelantan dan dialek Melayu Patani. Contohnya, akar [a.ka], belanar [bə.la.na] dan pakar [pa.ka].

Suku kata tertutup yang berakhir dengan [ur] dalam bahasa Melayu baku akan berubah menjadi suku kata terbuka [o] dalam dialek Melayu Kelantan dan dialek Melayu Patani. Contohnya, subur [su.bo], salur[sə.lo] dan alur [a.lo].

Suku kata tertutup dalam bahasa Melayu baku yang berakhir dengan [ir] akan berubah menjadi suku kata terbuka [e] dalam sebutan dialek Melayu Kelantan dan dialek Melayu Patani. Contohnya, tabir [ta.be], butir [bu.te] dan salir [sa.le].

Suku kata tertutup yang berakhir dengan [er] dalam bahasa Melayu baku akan berubah menjadi suku kata terbuka [ɛ] dalam dialek Melayu Kelantan dan dialek Melayu Patani. Contohnya, gedeber [gə.dɛ.bɛ], beleber [bə.lɛ.bɛ] dan jeleber [dʒə.lɛ.bɛ].

Bagi suku kata akhir diftong dalam bahasa Melayu baku, iaitu [ai] dan [au] berubah menjadi suku kata terbuka [a] dalam sebutan dialek Melayu Kelantan dan dialek Melayu Patani. Contohnya, pulau [pu.la], pantai [pa.ta] dan gulai [gu.la].

Bunyi konsonon [r] yang dilambangkan dengan huruf [r] dalam sebutan baku dilafazkan dengan bunyi yang seakan-akan bunyi [gh] di awal dan di tengah kata. Untuk bunyi ini digunakan lambang [ɣ]. Contohnya, beradu [bə. ɣa.du], bera [bə. ɣ ə], rajin [ɣa. dʒeŋ] dan rasa [ɣa.sə].

Bunyi [s] yang dilambangkan dengan huruf [s] dalam sebutan baku dilafazkan dengan bunyi [h] di akhir kata dalam dialek Melayu Kelantan dan dialek Melayu Patani. Contohnya, pedas [pə.dəh], pulas [pu. lah] dan panas [pa.nəh].

Penghilangan [m] berlaku apabila konsonon itu diikuti oleh konsonon [p], iaitu letupan bibir tak bersuara. Contohnya, lampu [la.pu], nampak [na.pəʔ] dan lumpuh [lu.poh].

Penghilangan [n] berlaku apabila konsonon itu diikuti oleh konsonon gigi-gusi [t], [s], [z] dan letusan langit keras [c]. Contohnya, bantal [ba.ta], tentu [tə.tu], ansur [a.so], insaf [i.sa], bancuh [ba. tʃoh] dan hancur [a.tʃo].

Penghilangan konsonon [ŋ] apabila diikuti oleh konsonon [k] dan [g], iaitu bunyi letupan langit lembut dan konsonon gigi-gusi [s]. Contohnya bangkai [ba.ka] dan pangkah [pa.kəh].

Persamaan dan Perbezaan Kata Nama

Pengkaji telah menyenaraikan 30 perkataan dari golongan kata nama hasil daripada pengamatan dan komunikasi yang berlaku antara pengkaji dengan pelajar-pelajar tahun 2 Jurusan Bahasa Melayu di YRU, pelajar-pelajar dari selatan Thai yang belajar di Universiti Malaysia Kelantan (UMK) dan mengambil kursus Bahasa Melayu Komunikasi serta pergaulan dengan rakan-rakan yang juga dari selatan Thai. Daripada 30 kata nama yang disenaraikan, hanya tiga kata nama yang digunakan dalam dialek Melayu Patani berbeza dengan dialek Melayu Kelantan iaitu /sughak/ bagi buku, doktor yang dipanggil /bomoh/ dan jendela yang disebut /pintu nate/ manakala 27 perkataan dalam dialek Melayu Patani adalah sama dengan dialek Melayu Kelantan seperti yang terdapat dalam Jadual 1. Senarai persamaan dan perbezaan kata nama dalam dialek Melayu Kelantan dan dialek Melayu Patani.

Jadual 1. Senarai Persamaan dan Perbezaan Kata Nama

No.	Dialek Melayu Kelantan	Dialek Melayu Patani	Bahasa Melayu Standard	Maksud Perkataan
1.	akok [a.kəʔ]	akok [a.kəʔ]	akok	sejenis kuih bakar yang dibuat daripada telur. tepung

				gandum, gula dan dibakar di dalam acuan
2.	awah [a.wah]	awah [a.wah]	rempah ratus	rempah ratus untuk masakan.
3.	awe [a.w ε]	awe [a.w ε]	awang	panggilan umum bagi orang lelaki yang muda daripada penutur
4.	balasoh [ba.la.s:ɔh]	balasoh [ba.la.s:ɔh]	surau	tempat beribadat (sembahyang, belajar agama, dan lain-lain) langgar, madrasah, surau
5.	baloh [ba.loh]	baloh [ba.loh]	kepek	rumah kecil yang dibuat khusus untuk menyimpan padi
6.	baroh [ba.ɣoh]	baroh [ba.ɣoh]	sawah	sawah padi
7.	bekwoh [b:εʔ.wɔh]	bekwoh [b:εʔ.wɔh]	kenduri	kenduri yang diadakan secara besar-besaran (majlis perkahwinan, kesyukuran, dan lain-lain)
No.	Dialek Melayu Kelantan	Dialek Melayu Patani	Bahasa Melayu Standard	Maksud Perkataan
8.	bidah [b:i.dah]	bidah [b:i.dah]	lastik	sejenis alat yang digunakan untuk melantingkan batu
9.	bledo [blə.dɔ]	bledo [blə.dɔ]	agar-agar	sejenis lumut laut yang telah diproses dan boleh digunakan untuk buat kuih
10.	blinde [blin.dɛ]	blinde [blin.dɛ]	belindan	kayu atau batu berbentuk empat segi bujur yang diletakkan di atas kubur
11.	bocong [bɔ.tʃɔŋ]	bocong [bɔ.tʃɔŋ]	termos	bekas menyimpan air panas (supaya tahan lebih lama)
12.	bute nako [bu.te na.kɔ]	bute nako [bu.te na.kɔ]	butir nangka/biji nangka	sejenis kuih yang diperbuat daripada tepuung pulut (berbentuk biji nangka), di masak bersama-sama santan, halba dan gula melaka.
13.	ca [tʃ:a]	ca [tʃ:a]	limbah	kawasan tanah rendah tempat menakung air kotor
14.	ceding [tʃə.din]	ceding [tʃə.din]	tunas	bahagian tumbuhan yang baru mengeuarkan daun
15.	cek [tʃeʔ]	cek [tʃeʔ]	ayah/emak	panggilan untuk ayah atau emak
16.	cek mek molek [tʃeʔ meʔ mɔl.εʔ]	cek mek molek [tʃeʔ meʔ mɔl.εʔ]	cek mek molek	sejenis kuih yang dibuat daripada keledak yang dilenyek, berbentuk lonjong, berisi gula pasir dan digoreng
17.	cek wo [tʃeʔ.wɔ]	cek wo [tʃeʔ.wɔ]	datuk	panggilan untuk datuk
18.	cekati [tʃə.ka.ti]	cekati [tʃə.ka.ti]	cekati	sejenis alat pembelah pinang yang diperbuat daripada besi (berbentuk seperti gunting)

19.	celeng [tʃɛ.lɛŋ]	celeng [tʃɛ.lɛŋ]	tabung	tempat menyimpan wang
20.	cepe [tʃɛ.pɛ]	cepe [tʃɛ.pɛ]	kuali	kuali
21.	cetong [tʃɛ.tɔŋ]	cetong [tʃɛ.tɔŋ]	gayung	gayung
22.	cok [tʃɔʔ]	cok [tʃɔʔ]	cangkul	cangkul
23.	colek [tʃ:ɔ.lɔʔ]	colek [tʃ:ɔ.lɔʔ]	sos pencicah	sambal cair dibuat daripada campuran cuka, lada, garam dan gula untuk dimakan bersama-sama keropok atau buah-buahan
24.	copong [tʃ:ɔ.pɔŋ]	copong [tʃ:ɔ.pɔŋ]	corong	corong asap
25.	cuco [tʃu.tʃɔ]	cuco [tʃu.tʃɔ]	baki	duit lebihan yang dipulangkan balik selepas membeli sesuatu
No.	Dialek Melayu Kelantan	Dialek Melayu Patani	Bahasa Melayu Standard	Maksud Perkataan
26.	dekcok [dɛʔ.tʃɔʔ]	dekcok [dɛʔ.tʃɔʔ]	tentang	permainan tradisional kanak-kanak yang dilakukan secara melompat-lompat menggunakan sebelah kaki mengikut petak-petak tertentu
27.	demo [dɛ.mɔ]	demo [dɛ.mɔ]	awak, engkau, kamu	kata ganti nama diri kedua
28.	bok [boʔ]	*sughak [suyɑʔ]	buku	buku
29.	dok.to [dɔʔ.tɔ]	*bomoh [bɔmɔh]	doktor	Orang yang berkelayakan dan bertauliah mengamalkan perubatan kesihatan
30.	jenelo [dʒɛnɛlɔ]	*pitu nate [pi.tu na.tɛ]	jendela/tingkap	tingkap rumah

Persamaan dan Perbezaan Makna Kata Adjektif

Hasil daripada pergaulan dan pengalaman dengan penutur dari tiga wilayah selatan Thai serta pengkaji sendiri penutur dialek Melayu Kelantan, pengkaji telah menyenaraikan 30 kata adjektif yang digunakan dalam kedua-dua dialek tersebut bagi mengenal pasti persamaan dan perbezaan kata adjektif yang digunakan. Jika diperhatikan kesemua kata adjektif yang disenaraikan oleh pengkaji adalah sama yang digunakan oleh penutur dialek Melayu Kelantan dan dialek Melayu Kelantan dalam perbualan harian mereka. Senarai kata adjektif ini dapat dilihat dalam Jadual 2. Senarai persamaan dan perbezaan kata adjektif seperti di bawah.

Jadual 2. Senarai Persamaan dan Perbezaan Kata Adjektif

No.	Dialek Melayu Kelantan	Dialek Melayu Patani	Bahasa Melayu Standard	Maksud Perkataan
1.	agah [ɑ.gah]	agah [ɑ.gah]	sombong, angkuh	sifat manusia sombong
2.	ayuk [ajuʔ]	ayuk [ajuʔ]	gayat	takut kerana berada di tempat tinggi

3.	bangak [ba.ŋaʔ]	bangak [ba.ŋaʔ]	segera, cepat, pantas	pergerakan yang laju
4.	beco [bɛ.tʃɔ]	beco [bɛ.tʃɔ]	bengkak dan bernanah	bengkak dan bernanah pada jar tangan atau kaki
5.	beduwa [bɛ.du.wã]	beduwa [bɛ.du.wã]	panas hati atau marah	perasaan marah
6.	bekrapoh [bɛ.kya.pɔh]	bekrapoh [bɛ.kya.pɔh]	berselerak	keadaan yang berselerak
7.	beleh [bɛ.lɛh]	beleh [bɛ.lɛh]	kurus	berkenaan orang, haiwan atau tumbuhan yang kecil dan kurus
No.	Dialek Melayu Kelantan	Dialek Melayu Patani	Bahasa Melayu Standard	Maksud Perkataan
8.	berek-berek [bɛ.ɣɛʔ. bɛ.ɣɛʔ.]	berek-berek [bɛ.ɣɛʔ. bɛ.ɣɛʔ.]	hujang berterusan	hujan yang turun secara berterusan
9.	bereng [bɛ.ɣɛŋ]	bereng [bɛ.ɣɛŋ]	jahat	perangai seseorang yang jahat seperti samseng
10.	berik [bɛ.yiʔ]	berik [bɛ.yiʔ]	kerdil	berkenaan saiz orang, pohon dan lain-lain yang tidak besar, bantut, terencat
11.	betak [bɛ.taʔ]	betak [bɛ.taʔ]	lembab	lambat melakukan sesuatu pekerjaan
12.	blana kokna [bla.na kɔʔ.na]	blana kokna [bla.na kɔʔ.na]	terlalu banyak	melimpah ruah
13.	bleming [blɛ.min]	bleming [blɛ.min]	berminyak	keadaan yang berminyak dan melekit
14.	bole [bɔ.lɛ]	bole [bɔ.lɛ]	hampir buta	penglihatan yang makin kabur
15.	cakduh [tʃaʔ.duh]	cakduh [tʃaʔ.duh]	tidak teliti	perangai yang cuai semasa melakukan sesuatu pekerjaan, tidak berhati-hati
16.	cemuh [tʃɛ.muh]	cemuh [tʃɛ.muh]	jemu, bosan	perasaan bosan
17.	cegek [tʃ:ɛ.ŋɛʔ]	cegek [tʃ:ɛ.ŋɛʔ]	terangkat sedikit	berkenaan kain, hidung dan lain-lain dalam keadaan terangkat sedikit
18.	cepelak [tʃɛ.pɛ.laʔ]	cepelak [tʃɛ.pɛ.laʔ]	celopar	mulut cakap lepas
19.	cering [tʃɛ.yin]	cering [tʃɛ.yin]	kering	keadaan kulit yang kering kerana kerap terdedah kepada cahaya matahari
20.	cero [tʃɛ.yɔ]	cero [tʃɛ.yɔ]	pudar	warna yang pudar
21.	jangok [dʒa.ŋɔʔ]	jangok [dʒa.ŋɔʔ]	cantik	perhiasan atau pakaian dalam keadaan yang sangat menarik apabila dipandang
22.	kesik [kɛ.siʔ]	kesik [kɛ.siʔ]	sunyi	perasaan sepi dan sunyi

23.	kere [kə.ɣɛ]	kere [kə.ɣɛ]	keras	buah atau kulit dan lain-lain yang menjadi keras
24.	lere[lɛ.ɣɛ]	lere[lɛ.ɣɛ]	tidak berdisiplin	tidak bersungguh membuat sesuatu
25.	nawok [n:a.wəʔ]	nawok [n:a.wəʔ]	bohong	bercakap tidak jujur
26.	petik [p:ə.tiʔ]	petik [p:ə.tiʔ]	berbintik-bintik	berbintik-bintik
27.	pohu [pɔ.hu]	pohu [pɔ.hu]	rapuh	biskut, kayu dan lain-lain yang mudah patah
28.	se'eh [sɛʔ.ɛh]	se'eh [sɛʔ.ɛh]	terlalu kenyang	terlalu kenyang selepas makan
No.	Dialek Melayu Kelantan	Dialek Melayu Patani	Bahasa Melayu Standard	Maksud Perkataan
29.	se'ik [s:ɛʔ.iʔ]	se'ik [s:ɛʔ.iʔ]	panas dan berpeluh	berkenaan badan yang panas dan berpeluh
30.	sebe [sə.bɛ]	sebe [sə.bɛ]	malap	cahaya yang malap dan suram

Persamaan dan Perbezaan Kata Kerja

Pengkaji telah mencatat 30 kata kerja yang digunakan oleh penutur dialek Melayu Kelantan dan dialek Melayu Patani semasa mereka bergaul sesama mereka. Pengkaji mendapati kesemua kata kerja yang disenaraikan itu adalah sama dan difahami oleh penutur dialek Melayu Kelantan dan dialek Melayu Patani. Hasil pengamatan pengkaji dapat dibuktikan dalam Jadual 3. Persamaan dan perbezaan kata kerja yang digunakan oleh masyarakat penutur dialek Melayu Kelantan dan dialek Melayu Patani seperti di bawah.

Jadual 3. Persamaan dan Perbezaan Kata Kerja

No.	Dialek Melayu Kelantan	Dialek Melayu Patani	Bahasa Melayu Standard	Maksud Perkataan
1.	badi [b:a.di]	badi [b:a.di]	bersaing, bertanding	perbuatan bersaing
2.	behe [bɛ.he]	behe [bɛ.he]	pukul	memukul sesuatu atau seseorang
3.	bloco [blɔ.tʃɔ]	bloco [blɔ.tʃɔ]	meleleh	mengalir biasanya darah, cecair
4.	bobok [b:ɔ.bəʔ]	bobok [b:ɔ.bəʔ]	berjenaka	melakukan perbuatan atau mengucapkankata-kata yang menimbulkan kelucuan, melawak
5.	bojeng [b:ɔ.ɖʒɛŋ]	bojeng [b:ɔ.ɖʒɛŋ]	gunting rambut	gunting rambut
6.	bolok [b:ɔ.ləʔ]	bolok [b:ɔ.ləʔ]	melekit, berair	berlumuran dengan sesuatu
7.	borak [b:ɔ.ɣəʔ]	borak [b:ɔ.ɣəʔ]	merebak	merebak daripada satu tempat ke satu tempat yang lain (menjalar, menular)
8.	bradu [bya.du]	bradu [bya.du]	berehat	berhenti daripada melakukan sesuatu

9.	brecek [byɛ.tʃɛʔ]	brecek [byɛ.tʃɛʔ]	lambat-lambat	membuat sesuatu secara beransur-ansur
10.	cakno [tʃaʔ.nɔ]	cakno [tʃaʔ.nɔ]	ambil berat	mengambil perhatian apabila disuruh berbuat sesuatu
11.	cekero [tʃə.kə.ʏɔ]	cekero [tʃə.kə.ʏɔ]	mengagak	mengagak
No.	Dialek Melayu Kelantan	Dialek Melayu Patani	Bahasa Melayu Standard	Maksud Perkataan
12.	cendeng [tʃ:ən.den]	cendeng [tʃ:ən.den]	halangan	rintangan semasa melakukan sesuatu pekerjaan atau majlis
13.	ceruk [tʃ:ə.yuʔ]	ceruk [tʃ:ə.yuʔ]	menyabit rumput	menyabit rumput
14.	dedeh [dɛ.dɛh]	dedeh [dɛ.dɛh]	menghabiskan	menghabiskan makanan dan lainlain perkara sehingga tidsk sedikit pun tertinggal
15.	glewak [glɛ.wãʔ]	glewak [glɛ.wãʔ]	menyibuk	mengganggu orang lain yang sedang membuat sesuatu
16.	gocoh [gɔ. tʃɔh]	gocoh [gɔ. tʃɔh]	menumbuk	memukul dengan tangan, meninju
17.	glecoh [glɛ.tʃɔh]	glecoh [glɛ.tʃɔh]	tergelincir	tergeluncur
18.	gori [g:ɔ.yi]	gori [g:ɔ.yi]	jualan awal	penjualan awal pada harga yang lebih rendah daripada harga asal agar jualan seterusnya laris
19.	grakak [gɣa.kãʔ]	grakak [gɣa.kãʔ]	ketawa	ketawa kanak-kanak yang masih kecil
20.	handeng [han.den]	handeng [han.den]	humban	membuang atau melemparkan sesuatua dengan kuat (kerana marah dan lain-lain)
21.	hungga [hun.ga]	hungga [hun.ga]	berlari	berlari dengan laju
22.	igak [i.gaʔ]	igak [i.gaʔ]	tangkap	tangkap
23.	jirek [dʒi.yɛʔ]	jirek [dʒi.yɛʔ]	pijak	meletakkan kaki pada sesuatu
24.	juwoh [dʒu.wɔh]	juwoh [dʒu.wɔh]	terserempak	terserempak
25.	kame [ka.mɛ]	kame [ka.mɛ]	mengadun, menguli	mengadun, menguli
26.	kapoh [ka.poh]	kapoh [ka.poh]	menggabungkan, mencantum	menggabungkan, mencantum
27.	kara [ka.ya]	kara [ka.ya]	menarik tali	menarik tali supaya bergerak ke arah diri sendiri

28.	keceh [kɛ,tʃɛh]	keceh [kɛ,tʃɛh] *keceh [kɛ,tʃɛh] nyekeh	menggores mancis api mengapi-apikan, menghasut mengetuk dengan ibu jari	menggores mancis api mengapi-apikan, menghasut mengetuk dengan ibu jari
No.	Dialek Melayu Kelantan	Dialek Melayu Patani	Bahasa Melayu Standard	Maksud Perkataan
29.	kecek [kɛ.tʃɛʔ]	kecek [kɛ.tʃɛʔ]	bercakap	bercakap
30.	lok [lɔʔ]	lok [lɔʔ] *halok [halɔʔ]	membiarkan	tidak peduli apa yang berlaku

Persamaan dan Perbezaan Kata Penguat

Pengkaji mendapati penggunaan kata penguat juga digunakan dalam dialek Melayu Patani dan dialek Melayu Kelantan. Kata Penguat ialah perkataan yang digunakan untuk menguatkan maksud kata adjektif. Kata penguat boleh hadir sebelum atau selepas kata adjektif. Antara kata penguat yang digunakan secara meluas dalam pertuturan dialek Melayu Kelantan dan dialek Melayu Patani adalah seperti begitu sekali, sungguh, sangat yang terdapat dalam Jadual 4.

Jadual 4. Senarai Persamaan Kata Penguat.

No.	Dialek Melayu Kelantan	Dialek Melayu Patani	Bahasa Melayu Standard	Maksud Perkataan
1.	gitu mo [g:i.tu mɔ]	gitu mo [g:i.tu mɔ]	begitu sekali	begitu sekali
2.	jolo [dʒo.lo]	jolo [dʒo.lo]	benarlah	memang demikian halnya, sungguh, sah, benar
3.	sengoti [sɛ.ŋɔ.ti]	sengoti [sɛ.ŋɔ.ti]	sungguh /betul	benar, sungguh, sah
4.	do'oh [d:ɔʔɔh]	do'oh [d:ɔʔɔh]	sangat	melampau

Perkataan yang masih digunakan dalam Dialek Melayu Patani tetapi jarang digunakan dalam Dialek Melayu Kelantan

Masyarakat Melayu di selatan Thai masih menggunakan perkataan-perkataan tertentu apabila berinteraksi secara bersemuka atau semasa berkomunikasi dengan juruhebah dalam siaran radio Yala-Savotho hasil daripada pengamatan pengkaji. Antara perkataan jarang digunakan di Kelantan tetapi masih dituturkan oleh masyarakat di selatan Thai adalah seperti yang tersenarai dalam Jadual 5.

Jadual 5. Perkataan masih digunakan dalam Dialek Melayu Patani tetapi jarang digunakan dalam Dialek Melayu Kelantan

No.	Dialek Melayu Patani	Dialek Melayu Kelantan	Bahasa Melayu Standard	Maksud Perkataan
1.	kelo [kə.lo]	kelo [kə.lo]	memanggil	memanggil
2.	henggo [hɛŋ.ɔ]	henggo [hɛŋ.ɔ]	lebih baik	rasa sakit yang makin baik
3.	jebo [dʒəbɔ]	jebo [dʒəbɔ]	jebul/ botol	bekas kecil seperti buyung yang dibuat daripada tembikar atau tembikar, cembul
4.	song [son]	song [son]	sesuai	serasi benar
5.	tepong [tə.pon]	tepong [tə.pon]	kuih	pelbagai jenis kuih

6.	gok [goʔ]	gok [goʔ]	penjara	jel
----	-----------	-----------	---------	-----

KESIMPULAN

Pada keseluruhannya, kajian ini menunjukkan bahawa dialek Melayu Kelantan adalah hampir sama dengan dialek Melayu Patani berdasarkan data yang disertakan dalam kajian ini. Sebanyak 100 perkataan yang dicatat dan disenaraikan sebagai data dalam kajian ini yang merangkumi 30 kata nama, 30 kata adjektif, 30 kata kerja, 4 kata penguat dan 6 kata yang jarang digunakan oleh penutur dialek Melayu Kelantan tetapi masih digunakan oleh penutur dialek Melayu Patani dalam perbualan harian mereka. Hanya 3 perkataan dalam golongan kata nama yang berbeza yang digunakan oleh penutur dialek Melayu Patani iaitu buku, bomoh dan jendela yang dikenal pasti daripada pengamatan pengkaji. Kesemua perkataan yang disenaraikan dalam golongan kata adjektif, kata kerja dan kata penguat adalah sama dituturkan dan difahami oleh penutur dialek Melayu Kelantan dan dialek Melayu Patani dalam kajian ini. Justeru, melalui senarai perkataan yang dicatat didapati dialek Melayu Kelantan yang dituturkan oleh masyarakat Kelantan lebih cenderung untuk mempunyai kedekatan dengan dialek Melayu Patani yang dituturkan oleh masyarakat Melayu yang tinggal di wilayah selatan Thai. Hal ini demikian kerana, dialek Melayu Kelantan dan dialek Melayu Patani adalah mempunyai hubungan kekeluargaan yang serumpun dan berlaku penyebaran dialek Melayu disebabkan kawasan geografinya yang bersempadan dan berjiran walaupun berbeza negara. Sekiranya ada perkataan yang berbeza, namun perbezaannya tidaklah begitu banyak. Ini bermakna dialek Melayu Kelantan dan dialek Melayu Patani memperlihatkan kesegaraman yang agak tinggi khususnya dari segi fonologi. Kadar keseragaman yang agak tinggi itu barangkali juga disebabkan oleh kurangnya pemasukan ciri-ciri dari luar. Jelas terbukti apabila penutur dialek Melayu Kelantan berkomunikasi dengan penutur dialek Melayu Patani, mereka dapat memahami antara satu lain kerana dialek yang diguna hampir sama dan proses komunikasi itu dapat berjalan lancar. Namun, apa yang dapat diperhatikan cara sebutan agak sedikit berbeza disebabkan kebiasaan penggunaan dalam kalangan penutur kedua-dua dialek tersebut namun ia tidak menghalang tujuan komunikasi itu diadakan. Kedua-dua dialek ini mempunyai keunikan yang tersendiri yang melambangkan keindahan dan kesantunan dialek serta menjadi kebanggaan penutur jati dalam masyarakat yang menuturkannya.

RUJUKAN

- Abdul Hamid Mahmood. 1994. *Sintaksis Dialek Kelantan*. Kuala Lumpur: Dewan Bahasa dan Pustaka.
- Ajid Che Kob. 1985. *Dialek Geografi Pasir Mas*. Bangi: Penerbit Universiti Kebangsaan Malaysia.
- Asmah Hj. Omar. 1985. *Susur Galur Bahasa Melayu*. Kuala Lumpur: Dewan Bahasa dan Pustaka.
- Brown, C.C. 1956. *Studies in Country Malay*. London: Luzac & Co.
- Collins. 1986. *Antologi Kajian Dialek Melayu*. Kuala Lumpur. Dewan Bahasa dan Pustaka.
- Halliday, M.A.K. 1968. The use and uses language. Dlm. *The Sociology of Language*, disunting oleh J. Fishman, 139-169. Mount: The Hague.
- Kamaruddin Isayah'.2019. Analisis Sosiolinguistik Masyarakat Melayu di Tiga Wilayah Sempadan Selatan Thai Berlandaskan Teori Etnografi Komunikasi. *Journal of Communication in Scientific Inquiry*. Vol (1), No. 1: 59-76.
- Nur Adibah Hasan & Syarifah Raihan Syed Jaafar. 2017. Struktur suku kata terbitan dialek Terengganu. *Akademika* 87 (1):165-175

- Saidatul Nornis Hj. Mahali. 2012. Situasi, peristiwa dan lakuan bahasa dalam kalang sama. *Akademika* 82(1):3-14
- Siti Noraini Hamzah & Nor Hashimah Jalaludin. 2018. Kepelbagaian varian leksikal dialek di Perak: Pendekatan Geographical Information System. *Akademika* 88(1):137-152.
- Sturrock, A.J. 1921. Some notes on Kelantan dialect, and some comparisons with the dialects of Perak and Central Pahang. *JMBRAS* 62(Disember)1-7.



Konsep Penerapan Nilai, Sahsiah dan Perpaduan dalam Program Sahsiah Unggul Murid (SUMUR) di Sekolah Menengah Kebangsaan

Mohd Shaleh Mislan
Universiti Kebangsaan Malaysia
p108442@siswa.ukm.edu.my

Mohd Isa Hamzah
Universiti Kebangsaan Malaysia
isa_hamzah@ukm.edu.my

Ab Halim Tamuri
Universiti Kebangsaan Malaysia
abhalim@ukm.edu.my

ABSTRAK

Pelan Pembangunan Pendidikan Malaysia 2013-2025 (PPPM 2013-2025) menggariskan 11 anjakan transformasi bagi mencapai aspirasi sistem pendidikan di Malaysia. Anjakan Ketiga iaitu melahirkan rakyat menghayati nilai telah menjadi indikator pelaksanaan program Sahsiah Unggul Murid (SUMUR) di Sekolah Menengah Kebangsaan (SMK). Kertas konsep ini meneliti beberapa kajian lepas tentang program SUMUR. Ia dikaji dari sudut modus operandi pelaksanaan program SUMUR serta konsep nilai, sahsiah dan perpaduan melalui medium usrah SUMUR. Kertas konsep ini menggunakan kaedah kepustakaan dan analisis dokumen. Kajian lepas secara umum mendapati terdapat kesan kepada elemen penerapan nilai, sahsiah dan perpaduan terhadap pelaksanaan program SUMUR. Hasil kajian ini diharapkan dapat memberi kefahaman ke atas matlamat pelaksanaan program SUMUR sekaligus berupaya melahirkan rakyat yang menghayati nilai.

Kata kunci: Nilai; Sahsiah; Perpaduan; Program; Sahsiah Unggul Murid (SUMUR)

PENDAHULUAN

Pembangunan nilai, sahsiah dan perpaduan di kalangan murid perlu seimbang dalam pembangunan intelek dan jasmani bagi menjamin kemakmuran dan kemajuan yang dicapai oleh Malaysia akan berkekalan di masa hadapan (Laporan Tahunan 2020 PPPM 2013-2025). Justeru, Anjakan Ketiga dalam PPPM 2013-2025 menekankan kepentingan untuk melahirkan masyarakat yang menghayati nilai. Inisiatif ini diambil bagi memastikan semua murid dilengkapi dengan nilai dan sahsiah yang murni seawal peringkat prasekolah hinggalah mereka tamat persekolahan pada peringkat menengah. Pelbagai usaha dan intervensi telah dirangka khusus oleh Kementerian Pendidikan Malaysia (KPM) untuk murid, guru dan pemimpin sekolah agar pembangunan nilai, sahsiah dan perpaduan ini berlaku secara holistik dan sistematik. Selain itu, identiti nasional yang kukuh melalui penghayatan prinsip Rukun Negara diperlukan untuk memastikan Malaysia berjaya menjadi sebuah negara bangsa serta memupuk rasa bangga dikalangan rakyat Malaysia tanpa mengira etnik, agama atau status sosioekonomi (PPPM 2013-2025).

Bagi mencapai aspirasi-aspirasi murni ini, tumpuan kepada pembangunan nilai, sahsiah dan perpaduan murid yang sebelum ini hanya terarah kepada aktiviti kokurikulum sahaja telah mula diperluaskan secara menyeluruh dengan turut memberi keutamaan kepada pengukuhan

program pembangunan sahsiah sedia ada di dalam dan di luar bilik darjah serta penyediaan perancangan strategik jangka panjang bagi pembangunan nilai dan sahsiah (KPM 2018). Selain itu, penerapan tiga nilai universal oleh Menteri Pendidikan iaitu kasih-sayang (*Love*), kegembiraan (*Happiness*) dan saling menghormati (*Mutual Respect*) telah menjadi teras dalam pemupukan nilai dan sahsiah murid (Maszlee 2021). Oleh itu, KPM melalui Bahagian Pendidikan Islam (BPI) telah melaksanakan pelbagai program pembangunan sahsiah murid. Beberapa program dalam kategori aktiviti kokurikulum telah diberi penekanan dan tumpuan. Antara program pembangunan sahsiah yang dirancang oleh BPI di sekolah-sekolah seluruh Malaysia ialah program Sahsiah Unggul Murid (SUMUR). Program ini pada asalnya hanya melibatkan sekolah menengah aliran agama iaitu Sekolah Menengah Kebangsaan Agama (SMKA) dan Sekolah Agama Bantuan Kerajaan (SABK). Pada tahun 2017, program ini kemudiannya telah diperluaskan kepada sekolah menengah harian seluruh Malaysia serta melibatkan murid bukan Islam (*non-muslim*). Hal ini kerana pihak KPM telah melaksanakan Indeks Kemenjadian Murid (IKM) bagi mengukur pencapaian murid dan mendapati bahawa Modul SUMUR bersesuaian dengan konsep pengukuran bagi dimensi Rohani (KPM 2017).

ISU DAN CABARAN SEMASA

Walaupun terdapat pelbagai inisiatif dan perancangan, usaha pemupukan nilai murni, sahsiah dan perpaduan dikalangan murid kini semakin mencabar berikutan asakan pengaruh negatif daripada persekitaran setempat dan juga pengaruh media sosial tanpa sempadan. Saban tahun, isu dan kes permasalahan sosial di kalangan murid menunjukkan peningkatan angka dan berada pada tahap yang membimbangkan khususnya masalah penzinaan, pembuangan bayi, khalwat, rogol dan penyalahgunaan dadah (Hasbullah, Ahmad Yussuf & Fakhrol Adabi 2020). Sebagai contoh, statistik daripada Agensi Anti Dadah Kebangsaan terhadap penyalahgunaan dadah dari bulan Januari hingga Jun 2020 mendapati taraf pendidikan di peringkat sekolah menengah merupakan angka yang dominan iaitu 62.4% melibatkan 59,555 orang (Agensi Anti Dadah Kebangsaan 2020). Manakala bagi kes remaja hamil luar nikah, Kementerian Kesihatan Malaysia melaporkan sebanyak 3,938 kes pada tahun 2016 dan 3,694 kes pada tahun 2017. Terdapat sedikit penurunan pada tahun 2018 iaitu sebanyak 2,873 kes yang telah dilaporkan (Kementerian Kesihatan Malaysia 2019). Statistik ini menunjukkan bahawa isu permasalahan sahsiah di kalangan remaja perlu diberi perhatian serius.

Selain itu, penghayatan akhlak yang cuba diterapkan dalam kehidupan murid melalui subjek Pendidikan Islam masih belum dapat membendung masalah akhlak muslim di dalam mahupun di luar sekolah (Ros Arniza Zakaria, Mohd Isa Hamzah & Khadijah Razak 2022). Menurut Norhisham dan Azmil Hashim (2017), selain pengaruh faktor pembelajaran subjek Pendidikan Islam, faktor persekitaran seperti cara seseorang itu dibesarkan dan menjalani kehidupan turut memberi pengaruh yang besar dalam melahirkan murid yang mempunyai pegangan, prinsip dan nilai Islam yang kukuh. Dalam hal ini, menurut Ibn Khaldun (1993), pembentukan sistem yang dikawal oleh akal manusia turut dibentuk melalui persekitaran. Melalui proses pembentukan sistem ini akan membentuk amalan budaya. Ini dapat dilihat melalui penerapan budaya *Iklm Dini* atau *Biah Solehah* di sekolah agama yang telah menjadi satu usaha berterusan ke arah pembentukan sahsiah unggul murid (Norhisham 2017). Menurut Norhisham (2017), konsep *Biah Solehah* merujuk kepada persekitaran keagamaan yang melibatkan pembangunan bersepadu diri manusia termasuk pembangunan intelek, rohani, emosi dan jasmani melalui penghayatan nilai dan amalan yang berterusan bersandarkan kepada ajaran tauhid serta berdasarkan Al-Quran dan Sunnah.

Dapatan berbeza dapat dilihat di dalam kajian oleh Sarimah et al (2011) yang membandingkan tahap penghayatan akhlak, amalan sosial dan penghayatan amalan agama murid sekolah menengah mengikut lima kategori sekolah dibawah KPM iaitu Sekolah Menengah Kebangsaan Agama (SMKA), Sekolah Berasrama Penuh (SBP), Sekolah Agama Bantuan Kerajaan (SABK), Sekolah Menengah Kebangsaan (SMK) dan Sekolah Menengah Teknik/Vokasional (SMT/V). Dapatan kajian menunjukkan tahap disiplin dan penghayatan agama murid Sekolah Menengah Kebangsaan Agama (SMKA) berada pada tahap cemerlang berdasarkan ketiga-tiga domain tersebut. Dapatan ini turut disokong oleh Wan Nor Adibah Wan Ahmad (2015), Muhammad Nordin (2017), Khalid Mat (2018) dan Mardziah Abd Aziz (2019) melalui pelaksanaan program SUMUR di SMKA. Kajian Wan Nor Adibah Wan Ahmad (2015) mendapati aspek amalan murid dalam ibadah dan amalan akhlak dan nilai murni dapat membentuk semangat jati diri muslim. Dapatan kajian Khalid Mat (2018) pula menunjukkan amalan murid dalam pelaksanaan modul SUMUR dalam aspek adab sopan, kualiti solat dan pemakaian adalah tinggi. Manakala dapatan Mardziah Abd Aziz (2019) menunjukkan pengamalan murid berdasarkan aktiviti modul SUMUR mencapai tahap sederhana tinggi merangkumi keempat-empat modul SUMUR. Manakala tahap penghayatan agama murid mencapai tahap tinggi bagi aspek akidah, ibadat dan akhlak. Dapatan pengkaji lepas telah menunjukkan bahawa tahap pengamalan murid terhadap pelaksanaan modul SUMUR adalah tinggi.

Walaupun terdapat kontradik isu dan permasalahan gejala sosial melibatkan nilai akhlak remaja kini, hakikatnya cabaran mendidik remaja tidak kira sama ada remaja tersebut bersekolah di sekolah agama atau sekolah harian biasa tetap wujud. Menurut Nurul, Wafaa dan Zuliza (2019), faktor penyumbang lain bermula dari faktor ibu bapa, kegagalan fungsi kekeluargaan, persekitaran sosiologi dan ekologi, ketegasan undang-undang dan ciri kanak-kanak sendiri turut diambil kira. Namun, iklim keagamaan dilihat mampu menangkis elemen tidak bermoral daripada meresapi jiwa murid di sekolah. Oleh itu, keperluan kajian pihak pemegang taruh dan para sarjana diperlukan bagi melihat bagaimana kualiti identiti diri murid dapat dibentuk (Nur Hanani et al 2021). Perubahan fizikal, emosi dan pemikiran yang dialami remaja merupakan fasa kritikal dimana mereka terdorong melakukan penyesuaian diri bagi mengatasi masalah identiti. Lantaran itu, sekolah yang merupakan medium pendidikan secara formal dan tidak formal berfungsi melibatkan murid dengan pelbagai aktiviti yang disediakan sekaligus mencorakkan penampilan dan jati diri murid secara tidak langsung.

Selain itu, agenda memupuk perpaduan turut mendapat perhatian di sekolah. Antaranya, pelaksanaan memperkukuh perpaduan melalui subjek Pendidikan Islam dan Pendidikan Moral telah meletakkan konstruk perpaduan dalam kedua-dua mata pelajaran ini (KPM 2015). Selaras dengan Dasar Perpaduan Negara (DPN) 2021-2030, KPM telah melakukan jajaran semula Pelan Hala Tuju Perpaduan dalam Pendidikan (2018-2023) yang sedia ada. Ini bagi memastikan satu pelan strategik yang bersepadu dapat mencapai aspirasi dan matlamat perpaduan dalam pendidikan serta difahami dan dihayati oleh warga pendidik dan murid. Manakala Laporan Kajian Pengukuran Tahap Perpaduan di Sekolah tahun 2021 mendapati tahap perpaduan di kalangan guru dan murid telah meningkat berbanding tahun 2018 dengan indeks 6.27 iaitu skor erat. Walau bagaimanapun, terdapat elemen yang perlu ditambah baik iaitu elemen perbezaan yang merangkumi toleransi, bersifat terbuka, bekerjasama dan percaya yang masih memerlukan tumpuan dan perhatian (Laporan Tahunan 2021 PPPM 2013-2025).

Justeru, memandangkan proses pembentukan nilai, sahsiah dan perpaduan merupakan proses berterusan, pada tahun 2017 pihak BPI telah mengambil inisiatif untuk meluaskan

pelaksanaan program SUMUR di SMK. Aspek pelaksanaan program SUMUR menggunakan empat teras utama iaitu Jati Diri, Penampilan Diri, Berbudi Bahasa dan Cara Hidup Beragama. Pelaksanaan program SUMUR turut melibatkan murid bukan beragama Islam. Oleh itu, pelaksanaan program SUMUR ini secara tidak langsung seiring dengan arahan penguatkuasaan Amalan Harian Bagi Perpaduan di Sekolah KPM iaitu memastikan penglibatan semua kaum dalam aktiviti atau program di sekolah.

PROGRAM SAHSIAH UNGGUL MURID (SUMUR)

Cetusan awal pelaksanaan program SUMUR bermula daripada idea Menteri Pendidikan Malaysia pada tahun 2007. Hasrat pelaksanaan program SUMUR telah disambut baik oleh Jabatan Pendidikan Islam dan Moral (JAPIM), KPM (yang kini dikenali sebagai BPI KPM). Beberapa siri bengkel anjuran BPI telah dijalankan pada tahun 2008 dan 2009 sehingga mencetuskan Modul 5C iaitu Murid Contoh, Murid Cerdas, Murid Cerdik, Murid Cergas dan Murid Ceria (KPM 2020). Matlamat program ini adalah untuk membentuk murid yang berakhlak mulia, boleh menjadi contoh tauladan dan *role model* kepada murid lain, berilmu pengetahuan, memiliki kesihatan yang baik, mempunyai jati diri yang mampan, berkarisma serta memiliki kemahiran kepimpinan dan semangat patriotisme. Program ini telah dilancarkan secara rasminya pada tahun 2007 di Sekolah Agama Bantuan Kerajaan (SABK) Tanjung Karang, Kuala Selangor. Susulan itu, sepuluh buah sekolah rintis telah terpilih untuk melaksanakan program ini.

Bermula tahun 2010, pelaksanaan program SUMUR telah dilaksanakan di semua SMKA dan SABK. Maka, pelaporan berpusat telah dilaksanakan bermula pada tahun 2012 melibatkan semua SMKA dan SABK di enam zon meliputi zon utara, zon tengah, zon selatan, zon timur, zon Sabah dan zon Sarawak. Aktiviti pemantauan turut dilaksanakan di beberapa buah sekolah terpilih di seluruh negara bagi memastikan pelaksanaan program ini berjalan sebagaimana dirancang (Panduan Sumur 2014). Sehubungan dengan itu, Mesyuarat Susulan Jemaah Menteri Bil.6/2014 memutuskan agar pihak KPM membina indeks pengukuran yang bersesuaian untuk mengukur pencapaian murid. Bahagian Perancangan dan Penyelidikan Dasar Pendidikan (BPPDP) yang dipertanggungjawabkan untuk membangunkan Indeks Kemenjadian Murid (IKM) telah mendapati bahawa Modul SUMUR bersesuaian dengan konsep pengukuran bagi dimensi rohani dalam indeks tersebut. Perkara ini seterusnya membawa kepada pelaksanaan program rintis SUMUR di 80 buah SMK terpilih seluruh negara bermula pada tahun 2017 hingga tahun 2019 (Panduan SUMUR 2019).

Dapatan pemantauan awal terhadap pelaksanaan rintis program SUMUR di 80 buah SMK terpilih seluruh negara sepanjang tahun 2017 hingga tahun 2019 membuktikan program SUMUR berjaya meningkatkan tahap budaya amalan baik di samping mengurangkan perbuatan salah laku disiplin dalam kalangan murid di sekolah tersebut sebagaimana dinyatakan dalam jadual 1 dibawah.

Jadual 1. Rekod Pemantaun Kes Disiplin 2019 (Panduan SUMUR 2020)

Tahun	Jumlah Kes Disiplin
2017	2,234
2018	1,487
2019	1,376

Pelaksanaan sepenuhnya program SUMUR di SMK menunjukkan usaha KPM dalam membangunkan potensi individu yang bersahsiah. Pelaksanaan program ini merupakan nilai

tambah pembelajaran diluar bilik darjah serta memperkukuhkan lagi pembelajaran kurikulum pendidikan Islam, pendidikan moral dan pendidikan sivik. Aktiviti dalam program SUMUR mampu mengelakkan murid daripada terjebak dengan aktiviti yang tidak sihat dan tidak berfaedah. Manakala pelaksanaan aktiviti SUMUR dilihat menjadi nilai tambah dalam amalan kehidupan seharian murid (Nor Anisa Musa, Nor Aniza Ahmad & Mohd Syaubari Othman 2022). Sejajar dengan itu, cadangan pelaksanaannya akan diperluaskan ke sekolah-sekolah rendah KPM menjelang pada tahun 2026.

KONSEP ASAS PROGRAM SUMUR

Konsep asas program SUMUR berteraskan objektif utama iaitu (i) memberi pengetahuan dan membina kesedaran murid terhadap akhlak (adab), kelakuan (etika dan tingkah laku) serta sahsiah (keperibadian); (ii) mengenal pasti nilai-nilai seperti kasih sayang (*love*), saling menghormati (*mutual respect*) dan bertanggungjawab (*responsibility*) dalam amalan seharian murid; dan (iii) menilai tahap peningkatan akhlak, kelakuan dan sahsiah murid. Kumpulan sasaran program ini melibatkan semua murid Islam dan bukan Islam di sekolah menengah KPM bermula daripada tingkatan peralihan hingga tingkatan 6 atas serta Institusi Pendidikan Swasta (IPS) yang berdaftar dengan KPM.

PELAKSANAAN PROGRAM SUMUR

Program SUMUR merupakan aktiviti tahunan yang merangkumi empat teras utama iaitu; Berbudhi Bahasa, Jati Diri, Penampilan Diri dan Cara Hidup Beragama. Keempat-empat teras utama SUMUR ini perlu dilaksanakan dan dinilai secara serentak. Rajah 1 dibawah merupakan kriteria setiap teras dalam program SUMUR.

Rajah 1. Kriteria Teras Program SUMUR



Pelaksanaan program SUMUR melibatkan aktiviti perbincangan dalam kumpulan antara murid iaitu aktiviti usrah SUMUR menggunakan modul yang terangkum dalamnya kandungan keempat-empat teras SUMUR. Aktiviti usrah SUMUR melibatkan kumpulan murid maksimum seramai 15 orang yang diketuai oleh seorang Mentor Murid (*Naqib*) dan guru bertindak sebagai pembimbing (*Murabbi*). Selain itu, aktiviti usrah menjadi medan untuk murid berbincang dan menjalankan aktiviti menggunakan modul yang dibekalkan oleh pihak

BPI KPM. Pelaksanaan aktiviti usrah SUMUR dilaksanakan pada kadar minimum sekali sebulan dengan peruntukan masa setengah jam (30 minit) di semua sekolah, sama ada di sekolah yang mempunyai asrama atau tiada asrama. Pelaksanaannya adalah diluar waktu persekolahan manakala masa pelaksanaan serta lokasi adalah mengikut kesesuaian sekolah.

Seterusnya, aktiviti penilaian program SUMUR adalah bersifat holistik dengan menilai individu murid bagi semua program dan aktiviti yang dilaksanakan disekolah menggunakan Borang Instrumen Penilaian SUMUR yang disediakan oleh BPI KPM. Kaedah penilaian individu adalah berdasarkan penilaian rakan sebaya dan pemerhatian guru melalui semua penglibatan murid dalam aktiviti dan program sekolah. Guru berperanan sebagai pembimbing dan pemudahcara yang bertanggungjawab untuk mengesahkan penilaian yang dibuat oleh murid (Mentor Murid) terhadap rakan-rakan mereka. Rubrik penilaian modul SUMUR adalah seperti jadual 2 dibawah.

Jadual 2. Rubrik Penilaian Modul SUMUR

Markah	Penerangan
1	AMALAN ASAS Pengetahuan pada perkara yang dinilai/masih dibimbing untuk mengamalkan/amalkan tanpa tahu sebab.
2	AMALAN MEMUASKAN Pengetahuan tentang perkara yang dinilai/amalkan dengan sendiri secara tidak konsisten.
3	AMALAN BAIK Amalkan perkara yang dinilai secara konsisten berdasarkan ilmu/mampu jelaskan kelebihan amalan itu.
4	AMALAN TERPUJI Amalkan perkara yang dinilai sebagai rutin seharian/menjadi <i>role model</i> yang membimbing orang lain.

Aktiviti pemantauan pelaksanaan SUMUR pula dijalankan oleh pegawai KPM, penyelarar SUMUR di Jabatan Pendidikan Negeri (JPN)/ Pejabat Pendidikan Daerah (PPD) dan pentadbir di sekolah masing-masing menggunakan Borang Pemantauan SUMUR KPM. Oleh itu, penilaian dan pemantauan wajar dilakukan agar program yang dijalankan kekal relevan mengikut situasi semasa. Hal ini kerana setiap penilaian program yang dilaksanakan akan menentukan sama ada program tersebut perlu kepada penambahbaikan, diteruskan atau digugurkan.

KAJIAN LEPAS BERKAITAN PROGRAM SUMUR

Kajian lepas antaranya memfokuskan aspek penilaian program SUMUR (Muhammad 2017), serta tahap penguasaan, amalan dan pembentukan murid terhadap modul SUMUR (Wan Nor Adibah (2015), Khalid Mat (2018), Mardziyah (2019), Nurul Nadirah & Hafizhah Zulkifli (2022). Secara umumnya, kajian-kajian ini mempunyai titik persamaan bahawa keterlibatan murid dalam program SUMUR mampu membangunkan sahsiah yang unggul dan penghayatan akhlak murid. Namun begitu, kajian lepas lebih memberi fokus kepada pelaksanaan program SUMUR di SMKA dan SABK berbanding di SMK.

Manakala, kajian oleh Nor Anisa, Nor Aniza & Mohd Syaubari (2022) menumpukan pelaksanaan program SUMUR di SMK dengan melihat faktor kecerdasan emosi, keterlibatan dan daya tahan murid. Walau bagaimanapun, kajian-kajian lepas berkaitan pelaksanaan program SUMUR kebanyakannya kurang memberi fokus terhadap aspek penerapan nilai, sahsiah dan perpaduan khususnya dalam aktiviti usrah SUMUR di SMK. Justeru itu, kajian mengenai pelaksanaan program SUMUR di SMK sewajarnya perlu diketengahkan memandangkan pelaksanaannya masih lagi diperingkat rintis. Tambahan pula, corak pelaksanaannya berbeza mengikut demografi kepelbagaian agama dan kaum.

USRAH SUMUR

Imam Hassan al-Banna merupakan salah seorang tokoh reformis massa pada abad ke 20. Melalui gerakan Ikhwanul Muslimin, beliau telah memperkenalkan konsep usrah atau keluarga. Konsep usrah merupakan sesi perjumpaan mengikut kumpulan sambil membincangkan hal ehwal semasa, keperluan ahli dan aktiviti-aktiviti tertentu. Kumpulan usrah ini diketuai oleh seorang *Naqib* yang berperanan untuk memimpin kumpulan masing-masing. Konsep usrah ini mementingkan ukhwah ataupun persaudaraan sesama ahli. Modus operandi usrah melibatkan perbincangan dan pandangan ahli usrah, seterusnya diterjemahkan melalui tindakan dan amalan. Dalam pelaksanaan program SUMUR, model usrah Hassan al-Banna diambil sebagai contoh dalam gerak kerja berkumpulan murid yang diketuai oleh seorang Mentor Murid (*Naqib*). Tiga objektif yang mendasari usrah SUMUR ialah At-Ta'aruf (Berkenalan), At-Tafahum (Persefahaman) dan At-Takaful (Bantu-membantu) (Modul Usrah SUMUR 2022).

At-Ta'aruf (Berkenalan)

At-Ta'aruf merupakan objektif pertama yang bermaksud sesi pengenalan bersama ahli kumpulan dengan menanamkan semangat berkasih sayang. Ahli kumpulan akan didedahkan dengan hakikat kepentingan ukhwah persaudaraan sejati diantara sesama saudara. Perkara yang boleh mengeruhkan perhubungan seboleh mungkin hendaklah dielakkan. Firman Allah SWT dalam Surah Al-Hujurat ayat 10:

إِنَّمَا الْمُؤْمِنُونَ إِخْوَةٌ فَأَصْلِحُوا بَيْنَ أَخَوَيْكُمْ وَاتَّقُوا اللَّهَ لَعَلَّكُمْ تُرْحَمُونَ ۝ ۱۰

Terjemahan: *Sebenarnya orang-orang yang beriman itu adalah bersaudara, maka damaikanlah di antara dua saudara kamu (yang bertelingkah) itu dan bertakwalah kepada Allah supaya kamu beroleh rahmat.*

Ibn Kathir menafsirkan bahawa seluruh muslimin adalah saudara seagama, apabila berlaku perselisihan antara dua golongan maka damaikanlah serta bertakwalah pada setiap urusan yang dilakukan agar beroleh rahmat daripada Allah SWT (Tafsir Ibn Kathir 2005). Hamka pula menafsirkan asas bagi keimanan ialah persaudaraan. Jika keimanan wujud dihati, tidak mungkin berlaku permusuhan melainkan kerana salah faham. Terdapat keperluan menyelidik punca kepada permusuhan supaya tidak timbul asbab kejahatan diri sendiri. Walaupun kedua belah pihak mempunyai pendapat masing-masing maka pihak ketiga perlu meleraikan perselisihan yang berlaku. Usaha membawa perdamaian tidak lain dan tidak bukan untuk mendapat keredhaan Allah semata-mata (Tafsir Al-Azhar 1989).

Daripada kedua-dua penafsiran ayat diatas tentang persaudaraan, dapat disimpulkan bahawa Allah SWT memerintahkan setiap orang yang beriman agar menjaga ukhwah persaudaraan sesama muslim. Apabila berlaku perselisihan antara dua golongan, maka

golongan ketiga diminta mendamaikan perselisihan yang berlaku. Maka sebagai seorang muslim, kemuncak kepada perdamaian adalah mengharap redha Allah SWT.

Selain itu, Allah SWT turut menukilkan hal berkenaan penciptaan manusia dari kepelbagaian bangsa dan suku. Firman Allah SWT dalam Surah Al-Hujurat ayat 13:

يَا أَيُّهَا النَّاسُ إِنَّا خَلَقْنَاكُمْ مِنْ ذَكَرٍ وَأُنثَىٰ وَجَعَلْنَاكُمْ شُعُوبًا وَقَبَائِلَ لِتَعَارَفُوا إِنَّ أَكْرَمَكُمْ عِنْدَ اللَّهِ أَتَقْوَاهُ إِنَّ اللَّهَ عَلِيمٌ خَبِيرٌ ۝١٣

Terjemahan: *Wahai umat manusia! Sesungguhnya Kami telah menciptakan kamu dari lelaki dan perempuan, dan Kami telah menjadikan kamu berbagai bangsa dan bersuku puak, supaya kamu berkenal-kenalan (dan beramah mesra antara satu dengan yang lain). Sesungguhnya semulia-mulia kamu di sisi Allah ialah orang yang lebih taqwanya di antara kamu, (bukan yang lebih keturunan atau bangsanya). Sesungguhnya Allah Maha Mengetahui, lagi Maha Mendalam Pengetahuannya (akan keadaan dan amalan kamu).*

Hamka menafsirkan bahawa seluruh manusia pada asalnya dari keturunan yang sama melalui susur galur Nabi Adam dan Siti Hawa. Walaupun telah jauh berpisah melalui peredaran zaman, asal keturunan tetap sama. Tiada perbezaan antara satu dengan lain melainkan menginsafi adanya persamaan keturunan. Oleh itu, perkara yang mulia di sisi Allah SWT ialah dari sudut kemuliaan hati, nilai, sahsiah dan ketaatan kepada Allah SWT (Tafsir Al-Azhar 1989).

Terdapat hubungan antara kedua-dua ayat diatas dalam pelaksanaan usrah SUMUR. Mengikut konteks usrah SUMUR, setiap ahli kumpulan mestilah menanamkan semangat persaudaraan sesama ahli. Walaupun wujud kepelbagaian agama dan kaum dalam ahli kumpulan, seharusnya semangat persaudaraan dan perpaduan wajar diterapkan. Hal ini menjadi bukti bahawa agama Islam sangat menitik beratkan unsur toleransi kepelbagaian kaum.

At-Tafahum (Persefahaman)

Objektif kedua ini bermaksud persefahaman antara sesama ahli kumpulan dalam hal saling nasihat menasihati. Permulaan nasihat dimulakan dengan melihat diri sendiri dahulu iaitu bermuhasabah jika ada melakukan kesilapan. Setelah bermuhasabah diri, ahli kumpulan pula saling nasihat menasihati di antara satu sama lain. Dalam konteks memberi nasihat terdapat beberapa etika yang diterapkan dalam kumpulan iaitu ahli yang diberi nasihat itu bersedia dan sanggup menerima nasihat dengan berlapang dada serta menghargai nasihat tersebut.

Seterusnya, pemberi nasihat tidak menganggap dirinya mulia serta tidak memandang rendah terhadap ahli yang dinasihatinya itu. Selain itu, adab memberi nasihat hendaklah menasihati dengan cara berhikmah tanpa menzahirkan secara terang kesilapan ahlinya dan tidak menceritakan kepada ahli lain. Jika tidak mampu menasihati ahlinya maka barulah ia menceritakan hal perilaku tersebut kepada Mentor Murid (*Naqib*). Dalam apa jua sekalipun, janganlah berasa tawar hati kepada ahli yang bersalah tersebut malah hendaklah sentiasa menjaga ukhwah sehingga muncul perubahan pada dirinya. Seharusnya, ahli yang diberi nasihat hendaklah tidak bersikap keras kepala kepada pemberi nasihat.

At-Takaful (Bantu-membantu)

Objektif ketiga ini bermaksud prinsip bantu-membantu memikul bebanan sesama sendiri. Dasar ini merupakan tunjang iman dan intisari ukhwah sejati. Untuk mengamalkan objektif ini

ahli kumpulan hendaklah sentiasa bertanya khabar sesama sendiri, ziarah-menziarahi dan segera menolong di antara satu sama lain. Dalam pada itu, Imam Al-Ghazali (2006) menukilkan ikatan persahabatan sebagai ikatan yang membawa kepada beberapa hak yang bersangkutan dengan harta, jiwa, lidah dan hati seperti memaafkan, mendoakan, ikhlas, memenuhi dan tidak memaksakan diri.

Dalam konteks pelaksanaan usrah SUMUR di SMK, adalah menjadi tanggungjawab ahli kumpulan usrah SUMUR untuk mencapai objektif ini dengan sebaik mungkin berdasarkan konsep saling percaya mempercayai dan menjaga etika kerahsiaan sesama ahli usrah SUMUR. Oleh itu, perbezaan yang merangkumi sosioekonomi, kaum, etnik, jantina, budaya, bahasa dan agama haruslah dilihat sebagai sesuatu yang melengkapikan dan menyatukan. Pelaksanaan usrah umumnya bersifat universal, tidak tertakluk kepada kumpulan tertentu dan tidak bergantung kepada pendekatan apa yang ingin disampaikan. Mengambil contoh antaranya kajian oleh Nor Nazihah & Razaleigh (2020) yang menumpukan pendekatan dakwah melalui usrah kepada golongan lesbian sebagai alternatif kembali kepada Islam. Pelaksanaan usrah ini sememangnya mampu menjadi medan tarbiyah dalam membangunkan sahsiah individu di samping membudayakan nilai-nilai moral dalam masyarakat (Fakhrul Adabi et al 2010). Sekolah merupakan institusi yang mudah bagi menghimpunkan murid untuk menjalankan aktiviti yang bermanfaat. Program usrah adalah aktiviti yang mustahak dan wajar digerakkan secara proaktif di sekolah (Salini 2009). Hal ini kerana peningkatan sahsiah secara sistematik melalui peringkat tertentu boleh diperolehi kerana program usrah yang dijalankan mempunyai matlamat tertentu (Mohd Said et al 2011). Rajah 2 di bawah merupakan model pembangunan sahsiah usrah SUMUR:

Rajah 2. Model Pembangunan Sahsiyah Usrah SUMUR

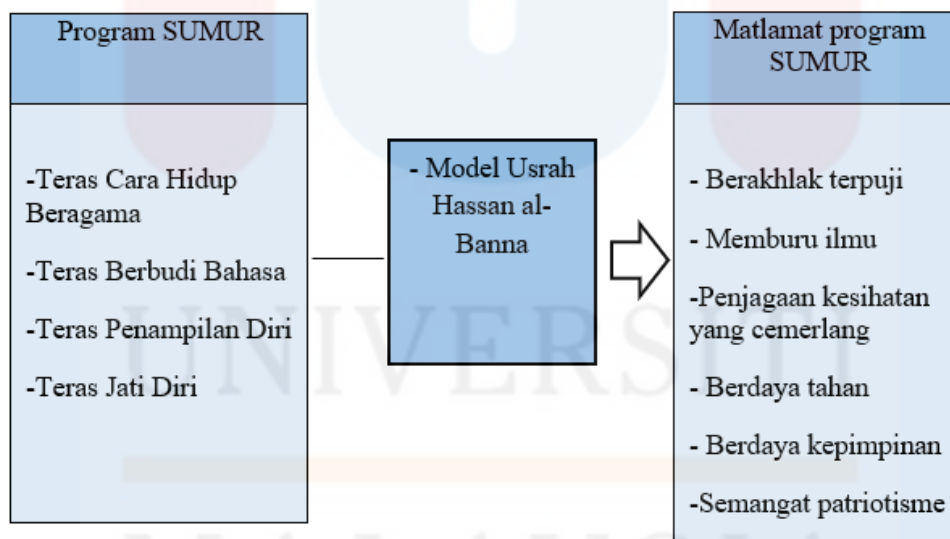

KESIMPULAN

Program SUMUR memasuki lembaran baru berikutan pelaksanaan program tersebut diperluaskan dari sekolah aliran agama kepada sekolah aliran perdana ataupun Sekolah Menengah Kebangsaan (SMK). Hal ini kerana, pihak Bahagian Perancangan dan Penyelidikan Dasar Pendidikan (BPPDP) yang dipertanggungjawabkan untuk membangunkan Indeks Kemenjadian Murid (IKM) telah mendapati bahawa Modul SUMUR bersesuaian dengan konsep pengukuran bagi dimensi Rohani dalam indeks tersebut. Pelaksanaan program SUMUR diselia dan dipantau oleh pihak BPI KPM. Pelaksanaan program SUMUR turut memperkukuhkan lagi program lain dibawah seliaan KPM seperti Program Pembangunan

Sahsiah Diri Murid (PPSDM) dan Rancangan Integrasi Murid Untuk Perpaduan (RIMUP). Selain itu, program SUMUR juga bertindak sebagai indikator bagi mencapai aspirasi murid dalam Pelan Induk Pembangunan Pendidikan 2013-2025. Oleh kerana penglibatan murid terdiri dari pelbagai latar belakang agama dan bangsa, peranan pihak sekolah dilihat memainkan peranan penting bagi memastikan konsep nilai, sahsiah dan perpaduan dapat dipupuk dengan sebaik mungkin. Secara keseluruhannya, kajian lepas membuktikan bahawa program SUMUR mampu memberi nilai tambah dari sudut sahsiah dan kemenjadian murid. Justeru itu, program ini akan disebar luas untuk semua sekolah rendah menjelang tahun 2025.

RUJUKAN

- Al-Imam Abul Fida Isma'il Ibnu Kasir Ad Dimasyqi. (1994). *Lubaabut Tafsiir Min Ibni Katsiir*. Mua'sasah Daar al-Hilal, Cairo
- Bahagian Pendidikan Kurikulum. (2015). *Buku Panduan Pelaksanaan Memperkukuh Perpaduan Melalui Mata Pelajaran Pendidikan Islam Dan Pendidikan Moral Dalam Kurikulum*. Kementerian Pendidikan Malaysia.
- Bahagian Pendidikan Islam. (2017). *Panduan Pelaksanaan Program Sahsiah Unggul Murid (SUMUR) di Sekolah Menengah / Sekolah Menengah Kebangsaan*. Kementerian Pendidikan Malaysia.
- Bahagian Pendidikan Islam. (2019). *Panduan Pelaksanaan Modul Sahsiah Unggul Murid (SUMUR) Di SMK*. Kementerian Pendidikan Malaysia.
- Bahagian Pendidikan Islam. (2022). *Panduan Pelaksanaan Modul Sahsiah Unggul Murid (SUMUR) Di SMK*. Kementerian Pendidikan Malaysia.
- Fakhrul Adabi Abdul Kadir, Kamarul Hazani Yusof, Ummu Hani Abu Hassan. (2010). Usrah Teras Pembangunan Insan: Tinjauan Pelaksanaannya Dalam Kalangan Para Pelajar Kolej Islam Sultan Alam Shah (Kisas). *Jurnal Usuluddin Universiti Malaya*.
- Hamka. (1989). *Tafsir Al-Azhar*. Pustaka Nasional PTE LTD.Singapura.
- Hasbullah Mat Daud, Ahmad Yussuf & Fakhrul Adabi Abdul Kadir. (2020) Pembentukan Akhlak Dan Sahsiah Pelajar Melalui Pembelajaran Sosial Menurut Perspektif Islam. *e-BANGI: Jurnal Sains Sosial dan Kemanusiaan*, 17 (9). pp. 75-89.
- Imam Al-Ghazali. (2006). Disunting oleh Abu Ezzat Al-Mubarak. *Mukhtasar Ihya' Ulumiddin*. Johor, Malaysia: Perniagaan JAHABERSA.
- Kementerian Pendidikan Malaysia. (2020). *Laporan Tahunan Pelan Pembangunan Pendidikan Malaysia 2013-2025 (PPPM 2013-2025)*.
- Kementerian Pendidikan Malaysia. (2021). *Laporan Tahunan Pelan Pembangunan Pendidikan Malaysia 2013-2025 (PPPM 2013-2025)*.
- Khalid Mat. (2018). *Pelaksanaan Modul Sahsiah Unggul Murid (SUMUR) Di Sekolah Menengah Kebangsaan Agama (SMKA) Dan Hubungannya Dengan Pembangunan Sahsiah Pelajar*. Tesis Ijazah Kedoktoran. Fakulti Pengajian Islam.Universiti Malaya.
- Mardziyah Ab Aziz. (2019). *Tahap Penghayatan Agama Murid Melalui Pengamalan Modul Sahsiah Unggul Murid (SUMUR) Di Daerah Rembau Negeri Sembilan*. Disertasi Sarjana. Universiti Kebangsaan Malaysia.
- Maszlee Malik. (2021). *Memori Bukan Memoir:20 Bulan Reformasi Pendidikan*. Malaysia: Perpustakaan Negara Malaysia.
- Mohd Said, Muhammad Nordin, Jamil Ahmad dan Ab Halim Tamuri. 2011. Pelaksanaan Program Usrah Badar di Sekolah Menengah Kebangsaan Agama (SMKA). (2011). *Prosiding Nadwah Ulama Nusantara (NUN) IV: Ulama Pemacu Transformasi Negara*. Fakulti Pendidikan, Universiti Kebangsaan Malaysia, Bangi, Selangor. 25-26 November 2011.

- Muhammad Nordin. (2017). *Penilaian Pelaksanaan Program Sahsiah Unggul Murid (SUMUR) Di SMKA*. Tesis Ijazah Kedoktoran. Fakulti Pendidikan. Universiti Kebangsaan Malaysia.
- Muhammad Norhisham. (2017). *Biah Solehah Dan Penghayatan Akhlak Pelajar Sekolah Menengah Kebangsaan Agama (SMKA)*. Tesis Ijazah Kedoktoran. Universiti Pendidikan Sultan Idris Shah.
- Nor Anisa Musa, Nor Aniza Ahmad & Mohd Syaubari Othman. (2022). Pembentukan Sahsiah Murid Melalui Program Sahsiah Unggul Murid (SUMUR) di Malaysia. *e-Jurnal Penyelidikan dan Inovasi*. Vol.9 No.1(April 2022): pp 109 -134.
- Nor Nazihah Awang @ Yaacob & Razaleigh Muhamat @ Kawangit. (2020). Pendekatan Dakwah Melalui Usrah Kepada Golongan Lesbian. *BITARA International Journal Of Civilizational Studies And Human Sciences*. Vol.3 Issue 1, 2020: 091-096.
- Nur Hanani Hussin, Mohamad Amin Abu Bakar, Mohd Syaubari Othman, Roslan Abu Hassan, Azizan Muhammad, Nor Anisa Musa, Salwa Awang & Siti Nur Fatimah Sahlan. (2021). *Kertas Laporan Kajian Keterlibatan dan Sahsiah Murid Sekolah Menengah Kebangsaan Yang Mengikuti Program Sahsiah Unggul Murid (SUMUR) Di Malaysia*. Bahagian Pendidikan Islam. Kementerian Pendidikan Malaysia.
- Nurul Izzah Izzati Hashim, and Wafaa Yusof, and Zuliza Mohd Kusrin. (2019) Pengabaian kanak-kanak dan jaminannya menurut syarak dan undang-undang di Malaysia. *Journal of Contemporary Islamic Law*, 4 (1). pp. 18-28.
- Nurul Nadirah Aw Ghazali & Hafizhah Zulkifli. (2022). Program Sahsiah Unggul Murid (SUMUR) Dalam Pembentukan Interpersonal Dan Intrapersonal Murid. *QALAM International Journal of Islamic and Humanities Research*.
- Ros Arniza Zakaria, Mohd Isa Hamzah & Khadijah Razak. (2021). Analisis Faktor Hisbah Sosial Terhadap Penghayatan Akhlak Murid Muslim Sekolah Menengah: Aplikasi Fuzzy Delphi Method. *ASEAN Comparative Education Research Journal on Islam and Civilization (ACER-J)*, Volume 4 (2) September 2021, 45-69.
- Salini Binti Mohd Salleh. (2009). *Persepsi Pelajar Terhadap Program Usrah Di SMKA (P) Al-Mashoor*. Disertasi Ijazah Sarjana Muda, Universiti Teknologi Malaysia.
- Sarimah Mokhtar, Mohd Kashfi Mohd Jailani, Ab. Halim Tamuri & Kamarulzaman Abdul Ghani. (2011). Kajian persepsi penghayatan akhlak islam dalam kalangan pelajar sekolah menengah di Selangor. *Global Journal AlThaqafah* 1(1): 71-78.
- Wan Nor Adibah bt Wan Ahmad. (2015). *Pembentukan Jati diri Muslim Melalui Pengamalan Modul Sahsiah Unggul Murid di Hulu Langat Dan Sepang Selangor*. Disertasi Sarjana. Universiti Kebangsaan Malaysia.

MALAYSIA

KELANTAN

Kesedaran Keselamatan Siber Semasa Pandemik COVID-19

Fatimah Rahmat
Politeknik Mersing, Johor, Malaysia
fatimah@tvet.pmj.edu.my

Nurul Shakirah Mohd Zawawi
Politeknik Mersing, Johor, Malaysia
shakirah@tvet.pmj.edu.my

Siti Rohani Sukaimi
Politeknik Mersing, Johor, Malaysia
sitirohani@tvet.pmj.edu.my

ABSTRACT

The emergence of the infectious disease COVID-19 has changed the daily activities of every individual around the world. Therefore, the use of applications based on telecommunications in the form of online video conferencing has become the main tool to communicate on a daily basis. However, this application is used by all internet users in a large user scale all of a sudden. This drastic change is the reason why this online meeting and collaboration platform is the main target for hackers to steal user's personal information without the user's permission for a specific purpose. This study aims to find out the factors of cyber security awareness, the importance of cyber security, and the best practices of internet users during COVID-19. This study is a quantitative research using a questionnaire method that has been carried out on 188 Diploma in Information Technology (Digital Technology) students who have followed the learning process using telecommunications in the form of video conferences provided by educational institutions. The results of the study found that the knowledge factor and the attitude factor were at a moderate level of interpretation, the need for cyber security awareness and the four best practices that internet users need to practice while online during the COVID-19 pandemic. Hopefully this study will benefit internet users regarding the importance of cyber security awareness.

Keywords: awareness; cyber security; COVID-19; video conferencing

ABSTRACT

Kemunculan penyakit berjangkit COVID-19 telah mengubah aktiviti harian setiap individu di seluruh dunia. Oleh yang demikian, penggunaan aplikasi yang berasaskan telekomunikasi berbentuk video konferensi secara dalam talian telah menjadi alat utama untuk berkomunikasi secara harian. Namun, aplikasi ini digunakan oleh semua pengguna internet dalam skala pengguna yang besar secara tiba-tiba. Perubahan drastik ini menjadi punca mengapa platform perjumpaan dan kolaborasi dalam talian ini adalah sasaran utama penggodam untuk mencuri maklumat peribadi pengguna tanpa kebenaran pengguna untuk tujuan tertentu. Kajian ini bertujuan untuk mengetahui faktor kesedaran keselamatan siber, kepentingan keselamatan siber, dan amalan terbaik pengguna internet semasa COVID-19. Kajian ini berbentuk kuantitatif menggunakan kaedah soal selidik yang telah dilaksanakan terhadap 188 orang pelajar Diploma Teknologi Maklumat (Teknologi Digital) yang telah mengikuti proses pembelajaran menggunakan telekomunikasi berbentuk video konferensi yang disediakan oleh institusi pengajian. Hasil kajian mendapati bahawa faktor pengetahuan dan faktor sikap berada pada tahap interpretasi sederhana, kepentingan kesedaran keselamatan siber semasa pandemik COVID-19 dan empat amalan terbaik yang perlu diamalkan oleh pengguna internet

semasa berada dalam talian. Semoga kajian ini mendapat manfaat kepada pengguna internet berkenaan kepentingan kesedaran keselamatan siber.

Kata Kunci: kesedaran; keselamatan siber; COVID-19; video kenferensi

PENGENALAN

World Health Organization (WHO) telah mengisytiharkan bahawa virus COVID-19 ini bersifat pandemik di mana wabak ini merebak secara besar-besaran ke seluruh dunia merentasi wilayah dan melibatkan populasi yang besar (WHO, 2020). Kementerian Kesihatan Malaysia (KKM) telah memperkenalkan tentang amalan kebersihan sebagai keutamaan dalam norma baharu semasa wabak pandemik ini (KKM, 2020). Rentetan daripada itu, semua urusan seperti perkhidmatan, pembelajaran, pembelian dan mesyuarat di semua organisasi telah berubah kepada bentuk transaksi secara atas talian secara sepenuhnya. Terdapat perbezaan yang ketara antara persekitaran norma biasa dan norma baharu. Berdasarkan Jadual 1, item keselamatan siber telah dijadikan keutamaan semasa pandemik ini bagi memastikan transaksi secara dalam talian berada dalam keadaan yang selamat semasa digunakan.

Jadual 1: Perbandingan norma biasa dan norma baharu.

Persekitaran Norma biasa	Persekitaran Norma baharu
<ul style="list-style-type: none">• Kelas bersemuka• Bekerja di pejabat• Orang ramai boleh keluar dengan mudah	<ul style="list-style-type: none">• Pendidikan pembelajaran dalam talian• Bekerja dari rumah• Keselamatan siber adalah keutamaan• Keutamaan penjagaan kesihatan• Perintah Kawalan Pergerakan Movement• Tiada perhimpunan besar

Sumber: Okereafor & Adebola (2020) dan Jayakumar et al. (2020)

KAJIAN LITERATUR

Keselamatan siber merupakan satu koleksi pengurusan yang melibatkan peralatan perisian, prosedur dan struktur pengoperasian organisasi yang bertujuan untuk melindungi sistem operasi digital daripada ancaman serangan pelanggaran hak milik (Craig et al., 2014). Menurut Khan et al. (2020), terdapat tiga jenis perisian berbahaya atau dikenali sebagai *malicious software* yang muncul semasa pandemik ini. Ia terdiri daripada domain berniat jahat, laman web berniat jahat dan pemesejan media sosial berniat jahat. Ketiga-tiga perisian berbahaya ini terhasil atas tindakan penyerang yang mengambil kesempatan terhadap pengguna Internet berkenaan isu pandemik COVID-19. Jika pengguna terdedah kepada perisian berbahaya ini, segala aktiviti dalam talian pengguna berada dalam keadaan tidak selamat. Oleh itu, keperluan pengetahuan berkenaan keselamatan siber adalah perlu bagi menjamin keselamatan dalam dunia digital masa kini.

Menurut Khan et al. (2020) dalam kajiannya, penggunaan aplikasi yang berasaskan telekomunikasi berbentuk video konferensi secara atas talian telah berlaku dalam skala besar tanpa ada pengujian daripada mana-mana pihak. Kesan terbesar daripada wabak pandemik ini menyebabkan tahap kebergantungan pengguna terhadap teknologi digital berada pada tahap yang tinggi (Okereafor & Adebola, 2020). Sebagai contoh, di awal penggunaan aplikasi Zoom, tetapan lalai aplikasi komunikasi Zoom adalah tidak selamat (Vigliarolo, 2020). Disebabkan itu, kajian Khan et al. (2020) mendapati penggunaan aplikasi komunikasi Zoom telah mendapat

kritikan daripada agensi dan institusi tertentu dan menyebabkan mereka mula mengelak daripada menggunakan aplikasi ini sebagai alat komunikasi. Ini adalah kesan daripada tiada fasa pengujian dalam skala yang besar dibuat terlebih dahulu. Disebabkan daripada kekurangan tersebut, aplikasi komunikasi Zoom telah mengemaskini tetapan lalai dan kini boleh digunakan dan dijamin selamat (Zoom Video Communications, Inc, 2020). Kesan daripada peristiwa hitam yang menimpa aplikasi komunikasi Zoom ini menyebabkan keselamatan siber telah menjadi keutamaan paling utama semasa pandemik ini (Jayakumar et al., 2020).

Institusi Pengajian Tinggi (IPT) menggunakan kaedah pembelajaran dalam talian ini sebagai keperluan utama antara tenaga pengajar dan pelajar (Chen et al., 2005). Platform pembelajaran dalam talian dibangunkan bertujuan untuk memudahkan pelaksanaan proses Pengajaran dan Pembelajaran (PdP) mengikut pedagogi sedia ada, tetapi isu keselamatan siber seperti isu kawalan keselamatan terhadap capaian data peribadi pelajar tidak diutamakan sepenuhnya (Bandara et al., 2014). Peralihan pembelajaran tradisional kepada pembelajaran dalam talian secara besar-besaran ini bermaksud lebih banyak data peribadi telah tersedia dalam talian yang boleh dicapai oleh penyerang dari pelbagai peranti (Samme-Nlar, 2020). Oleh sebab itu, platform perjumpaan dan kolaborasi atas talian adalah sasaran utama semasa wabak pandemik COVID-19 ini (Jayakumar et al., 2020). Penggunaan alat komunikasi berbentuk pembelajaran dalam talian segerak seperti Zoom yang beroperasi pada skala besar secara tergesa-gesa telah mewujudkan *vulnerabilities* (Samme-Nlar, 2020). *Vulnerabilities* ialah sesuatu kelemahan yang dapat dieksploitasi oleh penyerang siber untuk mendapatkan akses tanpa izin atau membuat tindakan yang tidak sah pada sistem komputer pengguna (Tunggal, 2020). Pengguna tahu akan berkenaan ancaman siber ini tetapi gagal dibuktikan melalui tindakan tingkahlaku mereka semasa menggunakan Internet (Furnell, 2008). Kajian Kruger & Kearney (2006), Parsons et al. (2014), Wahyudiwan et al. (2017) dan Yi & Hohashi (2019) telah membuktikan bahawa faktor tingkahlaku adalah salah satu faktor utama yang perlu ada untuk mengetahui kesedaran keselamatan siber pengguna. Tingkahlaku yang paling ketara ialah kecuaiannya (Furnell, 2008). Kajian (Saizan, 2018) merumuskan bahawa faktor persekitaran pengguna itu sendiri mempengaruhi kesedaran keselamatan siber pengguna.

Oleh itu, kajian ini bertujuan untuk mengetahui faktor kesedaran keselamatan siber, kepentingan keselamatan siber, dan amalan terbaik pengguna internet semasa COVID-19.

METODOLOGI

Kajian berbentuk deskriptif ini menggunakan pendekatan kuantitatif dengan soal selidik berskala Likert empat pilihan sebagai instrumen pengumpulan data. Proses pengumpulan data ini bermula pada 24 Disember 2020 sehingga 1 Julai 2021. Pembangunan instrumen soal selidik ini adalah merujuk kepada kajian Kruger & Kearney (2006), Parsons et al. (2014), (Wahyudiwan et al., 2017), (Yi & Hohashi, 2019) dan (Saizan, 2018). Responden diminta menilai tahap kesedaran keselamatan siber berdasar skala Likert 1 = Sangat Tidak Setuju (STS), 2 = Tidak setuju (TS), 3 = Setuju (S) dan 4 = Sangat setuju (SS). Soal selidik yang dibangunkan mengandungi empat bahagian seperti di dalam Jadual 2. Responden terdiri daripada 188 pelajar Diploma Teknologi Maklumat (Teknologi Digital) di Politeknik Mersing (rujuk Jadual 3). Skala Interpretasi Skor Min digunakan dalam kajian ini bagi tujuan interpretasi penilaian instrumen seperti Jadual 4. Oleh itu, kajian ini fokus untuk mengetahui kesedaran keselamatan siber terhadap pelajar Diploma Teknologi Maklumat (Teknologi Digital) Politeknik Mersing semasa wabak pandemik COVID-19 berlaku.

Jadual 2 : Bahagian komponen soal selidik

No.	Komponen
1	Profail responden
2	Pengetahuan Kesedaran Keselamatan
3	Sikap Kesedaran Keselamatan
4	Persekitaran Kesedaran Keselamatan

Jadual 3: Profail responden

	Item	Frekuensi	Peratus %
1	Jantina: Lelaki	74	39.4
	Perempuan	114	60.6
2	Umur: 20 ke bawah	147	78.2
	21	22	11.7
	22	9	4.8
	23	10	5.3
3	Semester pengajian: Semester 1	52	27.7
	Semester 2	21	11.2
	Semester 3	39	20.7
	Semester 4	41	21.8
	Semester 5	21	11.2
	Semester 6	14	7.45

Jadual 4: Skala Interpretasi skor min

Nilai Min	Tahap Interpretasi Min
0.00-2.33	Tahap Rendah
2.34-3.66	Tahap Sederhana
3.67-5.00	Tahap Tinggi

HASIL KAJIAN

Kajian ini bertujuan untuk mengetahui kepentingan keselamatan siber, faktor kesedaran keselamatan siber dan amalan terbaik pengguna internet semasa COVID-19. Hasil kajian adalah seperti berikut:

Faktor Kesedaran Keselamatan Siber Semasa COVID-19

Kajian Kruger & Kearney (2006), Parsons et al. (2014), Wahyudiwan et al. (2017) dan Yi & Hohashi (2019) telah membuktikan bahawa model KAB (Pengetahuan, Sikap, Tingkah laku) adalah model yang boleh digunapakai untuk mengetahui tahap kesedaran keselamatan siber pengguna. Kajian (Saizan, 2018) pula memperkenalkan model KAE (Pengetahuan, Sikap, Persekitaran) dalam kajiannya terhadap pengguna media sosial. Oleh itu, kajian ini telah menggabungkan model KAB dan KAE sebagai panduan asas untuk mengetahui faktor manakah yang mempengaruhi kesedaran keselamatan siber semasa pandemik COVID-19. Tiga faktor yang digunakan dalam kajian ini ialah Pengetahuan, Persekitaran dan Sikap (Rajah 1).

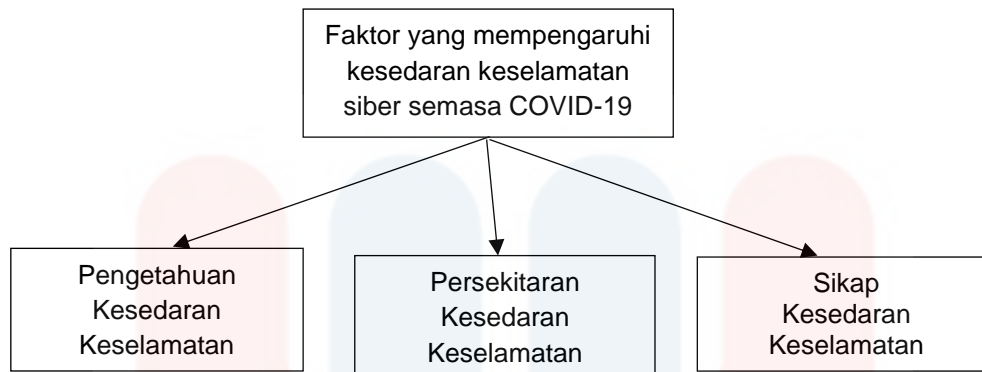

Rajah 1: Model Kesedaran keselamatan siber semasa COVID-19

Sumber: Kruger & Kearney (2006), Parsons et al. (2014), Wahyudiwan et al. (2017), Yi & Hohashi (2019) dan Saizan (2018)

Kepentingan Keselamatan Siber Semasa COVID-19

Kajian ini mendapati bahawa secara keseluruhannya, faktor pengetahuan kesedaran keselamatan bagi setiap responden adalah pada tahap sederhana (Jadual 5). Hanya 1 daripada 5 item soalan yang mencapai tahap interpretasi tinggi iaitu 94.1% peratus responden dengan nilai skor min 3.91 tahu berkenaan terma seperti HTTP, HTTPS, *spam* dan *phishing*. Walaupun responden sedang mengikuti pengajian teknologi maklumat, 4 item soalan masing-masing bernilai skor min 2.66, 2.44, 2.59 dan 2.80 pada tahap interpretasi sederhana. Oleh itu, perlunya tindakan peningkatan pengetahuan sendiri terhadap responden bagi memastikan pengetahuan responden sentiasa dipertingkatkan pada masa akan datang.

Jadual 5: Faktor Pengetahuan Kesedaran Keselamatan

Bil	Item	STS		TS		S		SS		Min	Interpretasi
		f	%	f	%	f	%	f	%		
1	Adakah anda menganggap diri anda mahir mengenai keselamatan siber?	5	2.7	67	35.6	103	54.8	13	6.9	2.66	Sederhana
2	Adakah anda mengetahui terma HTTP, HTTPS, <i>spam</i> dan <i>phishing</i> ?	0	0	6	3.2	5	2.7	177	94.1	3.91	Tinggi
3	Adakah anda fikir internet selamat?	14	7.4	87	46.3	78	41.5	9	4.8	2.44	Sederhana
4	Saya mempunyai pengetahuan yang mencukupi mengenai keselamatan maklumat	7	3.7	73	38.8	99	52.7	9	4.8	4.59	Sederhana

5	Saya mempunyai kemahiran untuk melindungi komputer dan data peribadi saya.	5	2.7	51	27.1	109	58.0	23	12.2	2.80	Sederhana
Purata Min										2.88	Sederhana

Faktor persekitaran kesedaran keselamatan bertujuan untuk mengetahui bagaimana persekitaran responden memberi impak kepada aktiviti atas talian (Jadual 6). 43.1% responden dengan nilai skor min 3.37 bersetuju program kesedaran siber perlu diterapkan di politeknik. 87.7% responden dengan nilai skor min 3.88 pula sentiasa memberi peringatan tentang ancaman siber kepada ibu bapa dan rakan-rakan. 77.7% responden dengan nilai skor min 3.77 bersetuju dengan kepentingan keperluan pendidikan keselamatan siber. Secara keseluruhannya, faktor persekitaran mempunyai tahap interpretasi yang tinggi dengan nilai skor min 3.67 berbanding faktor pengetahuan dan sikap.

Jadual 6: Faktor Persekitaran Kesedaran Keselamatan

num	item	STS		TS		S		SS		Min	Interpretasi
		f	%	f	%	f	%	f	%		
1	Adakah anda rasa perlunya program tambahan berkenaan kesedaran keselamatan siber di politeknik?	2	1.1	7	3.7	98	52.1	81	43.1	3.37	Sederhana
2	Saya sentiasa saling memperingati mengenai isu ancaman siber dengan ibubapa dan rakan-rakan	0	0	0	0	23	12.2	165	87.8	3.88	Tinggi
3	Education about information security is particularly necessary	0	0	1	0.5	41	21.8	146	77.7	3.77	Tinggi
Purata Min										3.67	Tinggi

Amalan Terbaik Pengguna Internet Semasa COVID-19

Berdasarkan hasil dapatan bagi faktor sikap kesedaran keselamatan, terdapat lima daripada tujuh item soalan yang mencapai tahap interpretasi tinggi (Jadual 7). Nilai skor min bagi lima item soalan tersebut ialah 4.00, 4.00, 3.96, 3.78 dan 3.94. Nilai skor min tersebut menunjukkan tahap kesedaran bagi faktor sikap adalah tinggi. Responden mengamalkan sikap penjagaan sendiri seperti penggunaan kata kunci yang kuat, penggunaan perisian daripada sumber yang

dipercayai, tidak berkongsi katakunci dan sentiasa menjaga peranti yang digunakan berada dalam pengawasan sendiri. Sikap tersebut adalah antara amalan baik yang telah diamalkan oleh responden terhadap peranti masing-masing semasa berada atas talian.

12.2% responden dengan nilai skor min 2.48 mengamalkan sikap penggunaan katakunci yang sama bagi akaun emel dan media sosial. Manakala hanya 3.2% responden dengan nilai skor min 2.86 sahaja yang mengemaskini perisian antivirus pada peranti mereka. Dua item tersebut meskipun berada pada tahap interpretasi sederhana, ia perlu sentiasa diingatkan bagi mencegah *vulnerabilities* untuk menyerang peranti semasa dalam talian. Secara keseluruhan sikap kesedaran keselamatan siber adalah berada pada tahap sederhana.

Jadual 7: Faktor Sikap Kesedaran Keselamatan

Bil	Item	STS		TS		S		SS		Min	Interpretasi
		f	%	f	%	f	%	f	%		
1	Saya selalu menggunakan kata laluan yang kuat pada komputer, e-mel dan akaun media sosial saya	0	0	0	0	0	0	188	100.0	4.00	Tinggi
2	Saya menggunakan kata laluan yang sama untuk kedua-dua akaun media sosial akaun e-mel	24	12.8	73	38.8	68	36.2	23	12.2	2.48	Sederhana
3	Saya sentiasa mengemas kini program antivirus komputer saya	6	3.2	46	24.5	105	55.9	31	16.5	2.86	Sederhana
4	Saya hanya memuat turun perisian atau program dari sumber yang dipercayai	0	0	0	0	2	1.1	186	98.9	4.00	Tinggi
5	Saya tidak berkongsi kata laluan saya kepada orang lain	0	0	0	0	8	4.3	180	95.7	3.96	Tinggi
6	Saya tidak akan meninggalkan komputer atau komputer riba tanpa pengawasan	0	0	3	1.6	35	18.6	150	79.8	3.78	Tinggi

7	Saya sentiasa mengamalkan tingkah laku amalan terbaik ketika menggunakan Internet.	0	0	0	0	12	6.4	176	93.6	3.94	Tinggi
Purata Min										3.57	Sederhana

KESIMPULAN

Kesimpulannya, kajian ini mendapati bahawa kesedaran keselamatan siber berada pada tahap memuaskan semasa pandemik COVID-19 berlaku. Kajian ini menemui penemuan bahawa faktor pengetahuan dan faktor sikap berada pada tahap interpretasi sederhana. Manakala faktor persekitaran adalah pada tahap interpretasi tinggi. Maklumbalas responden yang sentiasa peka dengan kewujudan ancaman keselamatan siber untuk diri sendiri dan juga orang tersayang membuktikan bahawa ilmu pengetahuan keselamatan siber perlu diberi keutamaan. Terdapat empat sikap amalan keselamatan siber yang wajar diamalkan oleh pengguna iaitu menggunakan kata kunci yang kuat, menggunakan perisian daripada sumber yang sah, tidak berkongsi atau mendedahkan kata kunci kepada orang lain dan sentiasa mengawasi peranti yang digunakan.

Secara keseluruhannya, kajian ini telah mencapai objektif kajian dengan baik. Kajian akan datang perlu fokus kepada perbincangan berkenaan kaedah bagi meningkatkan kesedaran keselamatan siber dari segi faktor pengetahuan dan sikap pengguna secara terperinci.

RUJUKAN

- Bandara, I., Ioras, F., & Maher, K. (2014). Cyber Security Concerns in E-Learning Education. *Proceedings of ICERI2014 Conference, November*, 728–734.
- Chen, N. S., Ko, H. C., Kinshuk, & Lin, T. (2005). A model for synchronous learning using the Internet. *Innovations in Education and Teaching International*, 42(2), 181–194. <https://doi.org/10.1080/14703290500062599>
- Craigien, D., Diakun-Thibault, N., & Purse, R. (2014). Defining Cybersecurity. *Technology Innovation Management Review*, 4(10), 13–21. <https://doi.org/10.22215/timreview835>
- Furnell, S. (2008). End-user security culture: A lesson that will never be learnt? *Computer Fraud and Security*, 2008(4), 6–9. [https://doi.org/10.1016/S1361-3723\(08\)70064-2](https://doi.org/10.1016/S1361-3723(08)70064-2)
- Jayakumar, P., Brohi, S. N., & Zaman, N. (2020). Top 7 Lessons Learned from COVID-19 Pandemic. *TechRxiv Powered by IEEE*, 1–6. https://www.techrxiv.org/articles/Ten_Deadly_Cyber_Security_Threats_Amid_COVID-19_Pandemic/12278792
- Khan, N. A., Brohi, S. N., & Zaman, N. (2020). Ten Deadly Cyber Security Threats Amid COVID-19 Pandemic. *TechRxiv Powered by IEEE*, 1–6. https://www.techrxiv.org/articles/Ten_Deadly_Cyber_Security_Threats_Amid_COVID-19_Pandemic/12278792
- Kruger, H. A., & Kearney, W. D. (2006). A prototype for assessing information security awareness. *Computers and Security*, 25(4), 289–296. <https://doi.org/10.1016/j.cose.2006.02.008>
- Okerefor, K., & Adebola, O. (2020). *Tackling the Cybersecurity Impacts of the Coronavirus Outbreak. February.*

- Parsons, K., McCormac, A., Butavicius, M., Pattinson, M., & Jerram, C. (2014). Determining employee awareness using the Human Aspects of Information Security Questionnaire (HAIS-Q). *Computers and Security*, 42, 165–176. <https://doi.org/10.1016/j.cose.2013.12.003>
- Saizan, Z. (2018). Cyber Security Awareness among Social Media Users: Case Study in German-Malaysian Institute (GMI). *Asia-Pacific Journal of Information Technology & Multimedia*, 07(02(02)), 111–127. [https://doi.org/10.17576/apjitm-2018-0702\(02\)-10](https://doi.org/10.17576/apjitm-2018-0702(02)-10)
- Samme-Nlar, T. (2020). *Cyberspace Security in Africa – Where Do We Stand? – Gefona*. <https://gefona.org/state-of-cyberspace-security-in-africa/>
- Wahyudiwan, D. D. H., Suchayo, Y. G., & Gandhi, A. (2017). Information security awareness level measurement for employee: Case study at ministry of research, technology, and higher education. *Proceeding - 2017 3rd International Conference on Science in Information Technology: Theory and Application of IT for Education, Industry and Society in Big Data Era, ICSITech 2017, 2018-Janua*, 654–658. <https://doi.org/10.1109/ICSITech.2017.8257194>
- Yi, Q., & Hohashi, N. (2019). Correction: Comparison of perceptions of domestic elder abuse among healthcare workers based on the Knowledge-Attitude-Behavior (KAB) model (PLoS One (2018) 13:11 (e0206640) DOI: 10.1371/journal.pone.0206640). *PLoS ONE*, 14(1), 1–14. <https://doi.org/10.1371/journal.pone.0210916>
- Zoom Video Communications, Inc (2020). Security Guide [White Paper]. <https://support.zoom.us/hc/en-us/articles/201362063-Security-White-Paper>

Konstruksi Falsafah Sains Islam Menerusi Ibnu Taymiyyah: Kerangka Teori Hubungan Akal dengan Wahyu dan Sebab-Akibat Sebagai Contoh

Muhammad Asrie bin Sobri

International Institute of Islamic Thought and Civilisation (ISTAC-IIUM)

asrie.sobri@live.iium.edu.my

Muhammad Fashan bin Ahmad Ziadi

International Institute of Islamic Thought and Civilisation (ISTAC-IIUM)

mfashan.z@live.iium.edu.my

Nik Md Saiful Aziz Nik Abdullah

International Institute of Islamic Thought and Civilisation (ISTAC-IIUM)

nikazizi@iium.edu.my

ABSTRACT

Among the approaches used in order to ward off prejudices of conflict between science and religion (revelation) is a philosophical approach that creates a philosophy of science that is parallel to the epistemology and point of view of Islamic metaphysics. One of the big issues in the formation of the Islamic philosophy of science is the theoretical framework of the relationship of revelation with science and the issue of cause-effect law. Among the leading Islamic figures in discussing these two issues is Ibn Taymiyyah (w.728 H/1328 C.E.). The researchers made his theory in the relationship of reason-revelation and his views on the law of causes as an example of the construction of the philosophy of Islamic science since his theoretical framework on the issue provided equality between Revelation and reason as well as his debate on the causality is successfully harmonizing between the law and the Divine destiny without compromising any party. The comparative approach of qualitative studies between the texts of Ibn Taymiyyah and the philosophical debate of modern science is used in this study by researchers, who further conclude that Ibn Taymiyyah's approach is suitable as a module of Islamic philosophy of science. The researchers believe that this study contributed new thoughts to the formation of the of Islamic philosophy of science.

Keywords: *Ibn Taymiyyah, Philosophy of Science, Modern Science, Islamic Epistemology, Law of Causality.*

ABSTRAK

Antara pendekatan yang digunakan dalam rangka menangkis prasangka wujudnya konflik antara sains dengan agama (wahyu) adalah pendekatan secara falsafah yang mewujudkan falsafah sains yang selari dengan epistemologi dan sudut pandang metafizik Islam. Antara isu besar dalam pembentukan falsafah sains Islam adalah kerangka teori hubungan wahyu dengan sains dan isu hukum sebab-akibat. Antara tokoh Islam yang terkedepan dalam membincangkan dua isu ini adalah Ibnu Taymiyyah (w.728 H/1328 M). Para pengkaji menjadikan teori beliau dalam hubungan akal-wahyu dan pandangan beliau berkenaan hukum sebab-akibat sebagai contoh pembinaan falsafah sains Islam memandangkan kerangka teori beliau dalam isu tersebut memberikan kesaksamaan antara Wahyu dengan akal demikian juga perbincangan beliau berkenaan sebab-akibat yang berjaya mengharmonikan antara hukum tersebut dengan takdir Ilahi tanpa mengkompromi mana-mana pihak. Pendekatan kajian kualitatif secara perbandingan antara teks-teks Ibnu Taymiyyah dengan perbincangan falsafah sains moden digunakan dalam kajian ini oleh para pengkaji yang seterusnya merumuskan bahawa pendekatan Ibnu Taymiyyah amat sesuai dijadikan sebagai modul falsafah sains Islam. Para

pengkaji percaya bahawa kajian ini menyumbangkan buah fikiran baharu dalam usaha pembentukan falsafah sains Islam.

Kata Kunci: *Ibnu Taymiyyah, Falsafah Sains, Sains Moden, Epistemologi Islam, Hukum Sebab-Akibat.*

PENDAHULUAN

Menjelang abad ke-20, isu konflik antara Sains dan Agama sudah menjadi tajuk asasi perdebatan teologi dan falsafah sama ada di Barat mahupun Timur. Umat Islam sendiri mempunyai pelbagai reaksi dalam menghadapi polemik ini.

Antara respon yang terbesar pernah digerakkan oleh Umat Islam untuk menghadapi polemik ini adalah gerakan Islamisasi Ilmu pada 1980-an menerusi tokoh-tokoh ilmuan Islam yang mendapat didikan campuran Barat dan Islam seperti *Isma'il Raji Al-Faruqi, Abdul Hamid Abu Sulayman, Syed Naquib Al-'Attas, Muhammad Kamal Hasan*, dan lain-lain (Berghout, 1433; *ISLAMIZATION OF KNOWLEDGE General Principles and Work Plan*, n.d.; Madani, 2016).

Islamisasi Sains menjadi salah satu lapangan utama gerakan Islamisasi Ilmu dalam usaha mengembalikan pendidikan sains kepada sudut pandang alam yang selari dengan Islam. Seruan untuk mewujudkan Sains Islam mula diperdengarkan dan muncul tokoh-tokoh yang mencurahkan usaha dalam merealisasikannya seperti *Syed Naquib Al-'Attas, Osman Bakar, Alparslan Acikgenc, Cemil Ekdogan, Muhammad Mumtaz Ali, Muzaffar Iqbal*, dan ramai lagi (Ahmad, 2008; Al-Attas, 1989; Mumtaz Ali, 2019).

Pendekatan yang popular diketengahkan oleh kebanyakan tokoh-tokoh Islamisasi Sains tersebut adalah pendekatan secara Falsafah iaitu dengan melakukan proses Islamisasi Falsafah Sains (Ahmad, 2008; Al-Attas, 1989).

Falsafah Sains merupakan cabang falsafah moden yang sangat penting, bertindak sebagai pemandu arah dan pengawal bagi kajian saintifik dan sains itu sendiri. Falsafah Sains mengkaji tiga lapangan asas berikut (Mumtaz Ali, 2019):

- Metodologi yang digunakan dalam kajian sains.
- Cara hipotesis dan undang-undang dirumuskan daripada bukti atau persoalan Epistemologi.
- Dasar-dasar yang digunakan oleh dakwaan sains untuk menjustifikasi keadaan alam atau isu-isu metafizik yang berkaitan sains.

Persoalan-persoalan yang ditimbulkan dan perlu dijawab oleh cabang falsafah ini antaranya (Blackburn, 2016; Chrisman & Pritchard, 2014; Mumtaz Ali, 2019; Thompson, 2013):

- Apakah sains itu sendiri? Apa yang membezakannya dengan bidang lain?
- Apakah itu teori sains dan kaitannya dengan dunia nyata? Bagaimana konsep sesuatu teori memperoleh maknanya dan kaitannya dengan pemerhatian?
- Apakah struktur konsep-konsep seperti: sebab-akibat, penjelasan, penegasan, teori, uji kaji, dan lain-lain?
- Apakah undang-undang yang mengawal perubahan teori dalam sains? Apakah fungsi eksperimen? Apakah peranan nilai etika dalam sains? Bagaimana nilai etika memberi kesan pada sosial, peradaban, dan isu gender?

Penentuan tabiat sains dan perbezaannya dengan cabang ilmu yang lain telah membawa kepada persoalan berkenaan hubungan sains dengan agama. Beberapa teori sains yang diterima secara meluas dalam kalangan saintis Barat moden dilihat sangat bercanggah dengan beberapa

ajaran asas agama secara umum dan Islam secara khusus seperti Teori Evolusi Darwin dan beberapa konsep metafizik yang menjadi asas sains seperti sebab-akibat mempunyai hubungan kait yang rapat dengan isu ketuhanan (Qada dan Qadar) (Brooke, 2014; Dixon, 2008; E. A. McGrath, 2010).

Oleh itu, isu hubungan sains dengan agama dan masalah sebab-akibat menjadi dua isu penting yang dibincangkan dalam Falsafah Sains dan juga Falsafah Agama sendiri. Memandangkan proses Islamisasi Ilmu merupakan kesinambungan daripada usaha para Ulama dan Ahli Falsafah Islam terdahulu, metodologi dan teori yang telah dirumuskan mereka menjadi panduan para tokoh Islamisasi moden, antaranya model Islamisasi yang dirumuskan oleh Al-Ghazali, Ibnu Rusyd, dan lain-lain.

Antara tokoh ilmuan Islam yang agung dan mempunyai jasa besar dalam Islamisasi Ilmu adalah Ibnu Taymiyyah ('Alwani, 1995). Para pengkaji di timur dan barat telah mengakui ketokohan beliau dan kepentingan mengkaji pemikiran dan falsafah beliau sebagai panduan menghadapi isu-isu pemikiran di masa kini.

Al-Imam Al-Akbar Muhammad Abdul Rahman Bisar²² menyatakan berkenaan Ibnu Taymiyyah (Al-Jalayand, 2000):

“dan Al-Imam Taqiyyuddin Ahmad bin Taymiyyah Al-Harrani adalah dalam kalangan mereka boleh dianggap sebagai Umat walaupun berseorangan, ke mana sahaja arah kamu hadapkan diri kamu untuk mengkaji ketokohan beliau, kamu akan bertemu pada setiap arahnya seorang tokoh yang menyerlah dan sangat layak untuk dilaksanakan kajian ilmiah ...”

Rapoport dan Ahmed (2015) menyatakan:

“Ibn Taymiyya was, by almost universal consensus, one of the most original and systematic thinkers in the history of Islam ... Reading Ibn Taymiyya is intellectually satisfying, as he is such a challenging and original thinker ... Because of his current standing in modern Islamic discourses, a faithful reading of his corpus matters for the future of Islam and of its relations with non-Muslims. Whether we like him or not, Ibn Taymiyya appears to be more relevant today than ever.”

Atas dasar pandangan yang sama berkenaan kepentingan mengkaji pemikiran dan falsafah Ibnu Taymiyyah dalam membina tamaddun baharu Islam, para penulis menyediakan kajian ini yang bertajuk: ***Konstruksi Falsafah Sains Islam Menerusi Ibnu Taymiyyah: Kerangka Teori Hubungan Akal dengan Wahyu dan Hukum Sebab-Akibat sebagai Contoh***.

Kajian ini akan memfokuskan pada isu hubungan sains dengan agama dengan berpandukan kerangka teori hubungan akal dengan wahyu yang digagaskan Ibnu Taymiyyah menerusi magnum-opus beliau: *Dar`u Al-Ta'arud bayna Al-'Aql wa Al-Naql* dan isu hukum sebab-akibat (Causation) yang sering dibahaskan oleh Ibnu Taymiyyah dalam beberapa karya beliau.

²² Beliau adalah mantan Syaikh Al-Azhar (1979-1982).

METODOLOGI

Metodologi yang para pengkaji gunakan adalah kajian kualitatif dengan melakukan penelitian terhadap teks-teks Ibnu Taymiyyah dalam isu berkaitan dibandingkan dengan pandangan falsafah sains barat moden dan penelitian para pengkaji muslim moden. Kajian ini diharapkan menyumbang kepada pengembangan dan pembentukan Falsafah Sains Islam yang dapat memurnikan kembali Sains Moden supaya selari dengan sudut pandang alam Islam dan nilai etikanya.

HUBUNGAN SAINS DENGAN AGAMA

Seperti yang telah disebutkan pada pendahuluan, pendekatan Ulama Islam terdahulu dalam kalangan Ahli Kalam seperti Al-Ghazali (Ahmed Malik, 2021) dan Ahli Falsafah seperti Ibnu Rusyd (Guessoum, 2011) telah menjadi pedoman dalam usaha Islamisasi Falsafah Sains. Namun, pendekatan Ahli Kalam dan Ahli Falsafah tersebut telah mendapat kritikan tajam daripada Ibnu Taymiyyah (El-Tobgui, 2020) dan beliau telah membentuk satu kerangka alternatif yang lebih kukuh dalam mengharmonikan akal dengan wahyu dan sekali gus pendekatan beliau ini akan menjadikan usaha Islamisasi Falsafah Sains lebih utuh jika dijadikan sebagai kerangka hubungan sains dengan agama.

Akal dan Wahyu atau Falsafah dan Agama Menurut Ibnu Taymiyyah:

Hubungan akal dengan wahyu menurut Ibnu Taymiyyah berteraskan keserasian dan kesepaduan antara kedua-duanya, akal adalah makhluk Allah ‘azza wa jalla sedangkal naqal atau wahyu adalah kalam Allah atau perkhbaran daripada Allah ‘azza wa jalla menerusi Rasul-Nya sallallahu ‘alaihi wa sallam. Segala percanggahan antara kedua-dua dalil ini pada hakikatnya adalah sangkaan sahaja, tiada percanggahan hakiki selama mana akal tersebut adalah akal yang sejahtera dan naqal pula adalah sah.

Secara asasnya, keseragaman antara ‘aqli dengan naqli dan ketiadaan percanggahan hakiki antara kedua-duanya adalah dasar yang telah disetujui antara semua Ulama Islam sama ada Ahli Kalam mahupun Ahli Falsafah, namun mereka berbeza dalam merungkai sangkaan percanggahan yang berlaku.

Ahli Kalam dan Ahli Falsafah mengambil pendekatan setiap kali berlaku sangkaan pertembungan antara dua jenis dalil, ‘aqli dan naqli, maka hendaklah dimenangkan sisi ‘aqli dengan dilakukan takwil atau tafwidh kepada teks-teks wahyu yang dianggap dalalnya bercanggah dengan ‘aqli (Al-Jalayand, 2000; Griffel, 2018). Ini kerana pada pandangan mereka, dalalah dalil naqli sama ada Al-Quran mahupun Sunnah tidak konklusif dan terdapat dalam teks-teks wahyu penggunaan lafaz yang tidak mewakili hakikat sebenar yang perlu diselidik dan dicari dengan pendalilan ‘aqli. (Al-Jalayand, 2000; El-Tobgui, 2020; Ibn Taymiyyah, 2008)

Ibnu Taymiyyah mengkritik tajam pendekatan ini yang ketara sekali melemahkan autoriti wahyu dan membuka ruang untuk interpretasi yang menyimpang berlaku terhadap agama. Maka beliau mengemukakan kerangka teori yang berteraskan tiga paksi berikut (Al-Fifi, 2021):

1. Menolak sebarang percanggahan antara dalil qat’i dengan dalil qat’i sama ada kedua-duanya ‘aqli atau naqli atau ‘aqli dan naqli.
2. Menerima kemungkinan berlaku percanggahan antara dalil yang bersifat zanni (tidak konklusif) dan dalam situasi ini hendaklah didahulukan dalil yang rajih (lebih kuat) berbanding marjuh (kurang kuat) baik yang didahulukan itu naqli atau ‘aqli.

3. Jika berlaku percanggahan antara dalil qat'i dengan zanni, maka semestinya didahulukan dalil qat'i sama ada ia naqli atau 'aqli ke atas dalil zanni baik ianya naqli mahupun 'aqli.

Ibnu Taymiyyah berpendirian bahawa kedua-dua jenis dalil sama ada 'aqli atau naqli, kedua-duanya berpotensi mempunyai dalalah qat'i atau zanni, maka pentarjihan mestilah bersandarkan kepada kekuatan dalalah tanpa mengambil kira jenis dalil sama ada 'aqli atau naqli kerana kedua-duanya adalah dalil yang diiktiraf syarak (Al-Fifi, 2021; El-Tobgui, 2020; Ibn Taymiyyah, 2008).

Maka hasilnya, kita boleh bahagikan situasi percanggahan antara dalil kepada empat situasi berikut (Al-Najjar, 2021):

1. Dalil Naqli yang qat'i dari sudut nisbah kepada sumbernya dan dalalahnya bercanggah dengan dalil qat'i 'aqli; situasi ini hanya sangkaan semata-mata kerana tidak mungkin berlaku percanggahan antara qat'i dengan qat'i.
2. Dalil Naqli yang zanni bercanggah dengan dalil 'aqli yang qat'i, maka yang didahulukan adalah 'aqli yang qat'i kerana ia qat'i bukan kerana ia daripada jenis 'aqli.
3. Dalil naqli qat'i bercanggah dengan dalil zanni 'aqli maka yang didahulukan dalil naqli kerana sifatnya yang qat'i bukan kerana ia dalil naqli.
4. Dalil 'aqli dan naqli, kedua-duanya zanni dan dilihat bercanggah, maka dilakukan pentarjihan dan didahulukan mana yang rajih ke atas marjuh.

Antara asas yang penting dalam pembinaan kerangka teori ini di sisi Ibnu Taymiyyah adalah:

Pertama: Dalil Naqli mengandungi dalil 'aqli, berbeza dengan sudut pandang Ahli Kalam dan Ahli Falsafah yang melihat kedua-dua jenis dalil ini terpisah, dalil naqli hanya bersifat memberitahu sahaja tanpa terkandung di dalamnya analogi akal dan petunjuk secara logik. Sebaliknya, di sisi Ibnu Taymiyyah, dalil-dalil 'aqli yang sahih, konklusif, dan sejahtera terkandung dalam naqli seperti kewujudan Tuhan, kebenaran Nabi dan Rasul, dan lain-lain.

Maka dalil yang absah di sisi syarak terdiri daripada dalil naqli dan dalil 'aqli dan kedua-duanya berlawanan dengan dalil 'aqli dan naqli yang tidak absah atau bidaah seperti syubhat dan hadis palsu. Ini tentu sekali berbeza dengan pandangan Ahli Kalam dan Ahli Falsafah yang membahagikan dalil kepada Syar'i iaitu dalil naqli dan dalil 'Aqli yang terpisah daripada Syar'i. (Al-Fifi, 2021; El-Tobgui, 2020; Ibn Taymiyyah, 2008)

Ibnu Taymiyyah menolak konsep ontologi Ahli Kalam dan Ahli Falsafah yang membahagikan hakikat yang wujud kepada *Mahsusat* dan *Ma'qulat*, menurut beliau setiap hakikat yang benar-benar wujud, mestilah ada kemungkinan untuk dicapai oleh pancaindera sama ada pancaindera zahir atau batin, maka realiti di sisi beliau terbahagi kepada *Al-Syahadah* dan *Al-Ghaib* sahaja (El-Tobgui, 2020; Ibn Taymiyyah, 2008; Samrin, 2020).

Kedua: Jalan untuk mencapai realiti ini tidak lain tidak bukan menerusi tiga perkara: pancaindera, akal, atau gabungan kedua-duanya seperti khabar. Maka ketiga-tiga jalan ini membawa kepada penyingkapan kebenaran maka tidak mungkin berlaku percanggahan. Manusia mencapai ilmu berkenaan perkara-perkara fizikal (*Syahadah*) menerusi pancaindera yang kemudian diproses akal, manakala maklumat berkenaan perkara *Ghaib* (Metafizik) diperoleh menerusi perkhbaran Wahyu yang terdiri daripada penggunaan pancaindera dan akal secara gabungan di mana akal tidak dapat memahami maksud berita yang disampaikan melainkan menerusi maklumat asas yang diperolehinya menerusi pancaindera. Sebagai contoh, apabila wahyu memberitahu adanya sungai daripada susu di dalam Syurga, berita ini hanya difahami menerusi pengalaman pancaindera berkenaan sungai dan

susu yang ada di dunia lalu akal mencapai maksud sungai susu di dalam Syurga secara Qiyas Al-Aula (Kiasan yang lebih utama). (El-Tobgui, 2020; Ibn Taymiyyah, 2008)

Ketiga: Capaian akal terhadap sesuatu hakikat adalah sebagai menyingkap kewujudan hakikat tersebut, bukan kerana sesuatu hakikat itu dicapai oleh akal maka ia wujud, sebaliknya sesuatu itu boleh dicapai oleh akal dan pancaindera kerana ia wujud. Maka secara asasnya, Ibnu Taymiyyah menolak pandangan Falsafah Idealisme dan menyokong fahaman empirisme yang menyatakan bahawa setiap benda yang wujud boleh dicapai oleh pancaindera dan kewujudan sesuatu realiti itu berbeza dengan capaian akal.

Oleh itu, apa jua perkhabaran wahyu adalah benar dan hakiki, sama ada akal mencapainya atau tidak, akal tidak menjadi sebab untuk sesuatu hakikat itu wujud atau benar, ia sekadar mencapai hakikat yang sedia ada dan diproses menjadi maklumat. (El-Tobgui, 2020; Ibn Taymiyyah, 2008)

Atas dasar keseragaman falsafah Ibnu Taymiyyah dalam Epistemologi dan Ontologi, beliau berjaya menghasilkan kerangka teori hubungan ‘aqli-naqli yang tidak menggadaikan autoriti mana-mana pihak dan mempertahankan autoriti wahyu daripada diremehkan.

Mengangkat Autoriti Naqal (Wahyu) Tidak Mencatatkan Autoriti Akal

Beliau juga mengemukakan hujah yang memperlihatkan bahawa mempertahankan kedudukan dan autoriti wahyu tidak merendahkan akal sama sekali bahkan ia merupakan kelaziman akal yang sejahtera untuk membenarkan wahyu dan sebaliknya jika akal mendepani wahyu dan meletakkan dirinya lebih tinggi berbanding autoriti wahyu, itulah yang mencatatkan akal dan merendahkan autoritinya. (Al-Fifi, 2021; Ibn Taymiyyah, 2008)

Analogi situasi ini diumpamakan akal seperti seorang awam mengenali Mufti yang berautoriti lalu dia memperkenalkan Mufti tadi kepada orang lain, jika berlaku pergeseran dan berbeza pandangan antara orang awam tadi dengan fatwa Mufti, maka perlulah diutamakan pandangan Mufti dan perbuatan mengutamakan pandangan Mufti tidak mencatatkan persaksian orang awam tadi bahawa Mufti tersebut adalah Mufti yang berautoriti. (Ibn Taymiyyah, 2008)

Maka demikianlah akal, telah menunjukkan kebenaran seorang Nabi dan mengakui kebenaran Nubuwwah baginda, maka setelah itu, jika terdapat beberapa pandangan akal yang dilihat bercanggah dengan apa yang disampaikan oleh Nabi maka wajiblah kita mengikut perkhabaran Nabi bukan mendustakan perkhabaran tersebut atas alasan untuk menjaga autoriti akal selaku saksi kebenaran Nabi. (Ibn Taymiyyah, 2008)

Demikian juga, hakikatnya, bukan semua pandangan akal itu berlawanan dengan wahyu, hanya sebahagian isu sahaja dan bukan dalam perkara yang zahir dan jelas. Isu-isu asasi dan jelas secara ‘aqli yang menjadi bukti kebenaran kenabian seorang Nabi tidak mungkin sama sekali bercanggah dengan wahyu kerana ia adalah syarat dan jalan untuk mencapai kebenaran tersebut.

Pandangan dan rumusan akal juga saling bercanggah antara seorang individu dengan individu dan ini dapat dilihat dengan nyata pada percanggahan dan perselisihan pendapat dalam kalangan Ahli Kalam dan Ahli Falsafah dalam teori-teori mereka, berbeza dengan Wahyu yang bersumber daripada Allah ‘azza wa jalla dan kita diperintahkan untuk kembali berhukum kepada keputusan Allah dan Rasul-Nya sallallahu ‘alaihi wa sallam ketika berlaku percanggahan, bukan kepada akal dan rumusannya. (Ibn Taymiyyah, 2008)

Isu Takwil dan Pendekatan Hermenueetik Terhadap Nas-nas Wahyu

Dalam rangka memartabatkan autoriti wahyu, Ibnu Taymiyyah menolak keras pendekatan Takwil (Hermenueetik) yang dilakukan oleh Ahli Kalam dan Ahli Falsafah kerana pada pandangan beliau, teks-teks Wahyu tidak membawa sebarang lafaz yang mengandungi makna yang bertentangan dengan logik. (Al-Fifi, 2021; Al-Jalayand, 2000; El-Tobgui, 2020; Ibn Taymiyyah, 2008)

Ibnu Taymiyyah menolak keras pendekatan Ahli Kalam dan Ahli Falsafah yang berpendirian nas-nas Wahyu diturunkan untuk bimbingan orang awam, sedangkan ahli akal (Ahli Kalam dan Ahli Falsafah) perlu mencari hakikat sebenar dengan pemikiran mereka kemudian mengubah makna nas wahyu supaya selari dengan kesimpulan pemikiran tersebut.

Sebarang teks atau ayat Al-Quran atau hadis Nabi sallallahu ‘alaihi wa sallam yang disangka membawa makna yang tidak layak berkenaan sifat-sifat Allah ‘azza wa jalla, sebagai contoh, tentu akan dijelaskan sendiri oleh nas-nas Wahyu dan tidak akan dibiarkan kepada akal semata-mata untuk mencari-cari maknanya.

Pendirian beliau ini terbina di atas keyakinan utuh beliau bahawa naqli dan ‘aqli adalah satu, bersumber daripada Allah ‘azza wa jalla dan wahyu diturunkan untuk membimbing akal, maka mustahil terdapat dalam mana-mana lafaz Al-Quran atau Sunnah Nabawiah percanggahan dengan logik akal walaupun terdapat pemberitahuan wahyu itu yang menghairankan akal namun tetap ia sesuatu yang logik dan serasi dengan akal. (Al-Fifi, 2021; Al-Jalayand, 2000; El-Tobgui, 2020; Ibn Taymiyyah, 2008)

Ibnu Taymiyyah menerima konsep Takwil dengan makna Tafsir yang berpandukan kepada pemahaman generasi Al-Salaf Al-Soleh; para Sahabat radiallahu ‘anhum, Tabi’in, dan Tabi’ Tabi’in. Tujuan takwil mestilah untuk mencapai maksud sebenar penutur bukan sekadar untuk mengubah makna kalam untuk bersesuaian dengan kesimpulan akal seseorang. (Al-Jalayand, 2000; Ibn Taymiyyah, 2008)

Hubungan Sains dengan Agama Berdasarkan Kerangka Hubungan ‘Aqli-Naqli

Setelah mana kita mengetahui konsep dan kerangka teori hubungan ‘aqli-naqli menurut Ibnu Taymiyyah, maka di sini para pengkaji akan melakukan konstruksi kerangka hubungan sains moden dengan agama yang telah menggantikan polemik ‘aqli-naqli di zaman kini.

Ulama Islam secara dasarnya berkeyakinan bahawa tiada percanggahan hakiki antara penemuan sains dengan nas-nas wahyu kerana alam ini adalah makhluk ciptaan Allah ‘azza wa jalla dan bukti ketuhanan, keesaan, dan keagungan-Nya dan disebut sebagai ‘Al-Kitab Al-Manzur’, manakala Wahyu Ilahi adalah kalam Allah ‘azza wa jalla atau pemberitahuan Allah menerusi Rasulullah sallallahu ‘alaihi wa sallam maka tidak mungkin berlaku pertembungan kerana sumbernya adalah sama. (Ahmad, 2008; Azmi, 2019)

Asas keharmonian ‘aqli-naqli yang digagaskan oleh Ibnu Taymiyyah menjadi teras dalam hubungan sains dan agama. Sebarang pertembungan antara fakta atau teori sains dengan perkhawaran wahyu bukanlah pertembungan hakiki dan dapat diharmonikan dengan kaedah yang sama mengharmonikan ‘aqli-naqli. (Azmi, 2019)

Dapatlah kita rumuskan satu kaedah: *“Jika berlaku sangkaan pertembungan antara sains dengan wahyu maka hendaklah dilihat; jika kedua-duanya bersifat qat’i maka pertembungan adalah mustahil sama sekali. Jika bertembung antara qat’i dengan zanni, maka didahulukan yang zanni baik ianya sains atau wahyu. Jika berlaku percanggahan antara zanni dengan zanni maka dilakukan tarjih dan didahulukan yang rajih atas yang marjuh baik ianya sains atau wahyu”*. (Al-Najjar, 2021; Azmi, 2019)

Antara isu asas sains moden yang membawa pertembungan dengan agama adalah kerana saintis barat moden menghadkan sudut pandang mereka kepada sumber pancaindera

dan menolak keimanan terhadap ghaib (Al-Attas, 1989; Mumtaz Ali, 2019). Jika kita merujuk kepada metode epistemologi dan ontologi Ibnu Taymiyyah, sumber ilmu mestilah merangkumi: pancaindera, akal, dan gabungan kedua-duanya seperti khabar(El-Tobgui, 2020; Samrin, 2020).

Maka hubungan antara Sains dengan agama boleh disifatkan sebagai berintegrasi dan separa bertindan kerana terdapat maklumat yang boleh kita perolehi menerusi pancaindera dan akal yang tidak perlu menunggu perkhawaran wahyu berkenaannya iaitu *Al-Syahadah* dan ada perkara-perkara ghaib yang perlu pemberitahuan wahyu.(Azmi, 2019)

Antara perkara yang jelas dalam Al-Quran apabila berbicara berkenaan Al-Syahadah, Allah ‘azza wa jalla memerintahkan kita melakukan pemerhatian dan penelitian seperti perintah supaya kita berjalan di muka bumi dan memerhatikan kesudahan umat terdahulu yang derhaka kepada Rasul mereka, perintah untuk kita memerhatikan keadaan unta yang merupakan tunggangan utama Arab, memerhatikan gunung-ganang, langit, dan permukaan bumi. Perkara-perkara sebegini yang boleh kita capai dengan penelitian pancaindera dan rumusan akal, tidak perlu lagi perkhawaran wahyu untuk memperincikannya.

Namun, ada kejadian dalam alam ini yang di luar jangkauan pancaindera kita sekarang seperti kewujudan Syurga dan Neraka, Malaikat, dan kejadian awal makhluk sendiri seperti penciptaan langit, bumi, dan manusia itu sendiri. Ini semua adalah perkara ghaib yang tidak disaksikan oleh pancaindera dan rumusan akal hanya mampu melakukan telahan dan tekaan sahaja, maka perkara sebegini menjadi autoriti wahyu sepenuhnya.

Kebanyakan teori sains bahkan beberapa perkara yang dianggap fakta sains juga, hakikatnya bersifat zanni (Mumtaz Ali, 2019; Thompson, 2013), sebagai contoh: *Teori Letupan Besar* sebagai permulaan kejadian alam adalah zanni kerana kejadian tersebut tidak dapat dicapai secara terus oleh pancaindera, hanya bersandarkan kesimpulan fakta yang dapat dicapai bahawa alam semesta ini berkembang. Namun, adakah mesti pengembangan dan perluasan itu bermula dengan letupan? Ini bukan sesuatu yang pasti (qat’i) kerana harus pada akal beberapa kemungkinan yang lain memandangkan sebelum kewujudan alam ini, hukum alam yang ada sekarang belum ada. Disebabkan tiada nas wahyu yang mengiakan atau menidakkan teori ini, maka ia boleh sahaja diterima namun bukan sebagai satu fakta yang muktamad.(Al-Najjar, 2021)

Berbeza pula dengan fakta bahawa kejadian alam ini meluas dan mengembang bahawa ia mempunyai permulaan, bahawa ada satu ketika alam ini belum wujud, ini adalah kesimpulan pancaindera dan hukum akal yang daruri bahawa setiap kejadian yang baharu berlaku mesti ada pembuatnya. Tentu sahaja fakta yang qat’i ini serasi dan sejalan dengan perkhawaran wahyu bahawa alam ini baharu dan diciptakan oleh Allah ‘azza wa jalla. (Meyer, 2021)

Antara teori sains yang sering dianggap sebagai titik pertembungan utama sains dengan agama adalah teori evolusi Darwin yang menganggap organisma hidup termasuk manusia berpunca daripada perubahan spesies yang berasal daripada moyang yang sama(Ahmed Malik, 2021; Azmi, 2016, 2019; Brooke, 2014; Harari, 2019; A. M. C. J. McGrath, 2007; *Religion and Science (Stanford Encyclopedia of Philosophy)*, n.d.; Stenger, 2012). Manusia itu -menurut teori ini- adalah perubahan daripada spesies *Ape* (Mawas) di mana ‘enam juta tahun yang lalu, seekor mawas betina mempunyai dua anak perempuan, salah satunya menjadi moyang chimpanzi dan satu lagi menjadi moyang manusia’(Azmi, 2016; Harari, 2019; Lo et al., 2020).

Teori sebegini sudah tentu jelas berlawanan dengan perkhawaran wahyu berkenaan asal-usul kejadian manusia yang diciptakan Allah ‘azza wa jalla secara langsung daripada tanah lalu ditiupkan ke dalam jasadnya ruh, lalu jadilah manusia pertama iaitu Adam ‘alaih salam yang kemudian berpasangan dengan isterinya Hawwa` dan melahirkan umat manusia.(Al-Najjar, 2021; Azmi, 2016, 2019)

Jika diperhatikan dengan saksama, kita akan dapati bahawa teori evolusi Darwin ini bukanlah sesuatu yang qat’i kerana ia tidak dicapai secara terus dengan pancaindera, bahkan,

kejadian manusia yang terawal adalah peristiwa ghaib yang tidak disaksikan oleh sesiapa pun daripada kita. Teori evolusi ini hanyalah telahan dan tekaan yang bersifat zanni, maka dalam situasi ini selayaknya perkhabaran wahyu didahulukan dan teori evolusi ini dihukum sebagai salah. Apatah lagi, teori ini sendiri bukanlah sesuatu yang diterima secara konsensus oleh saintis barat sendiri, bahkan kini sudah muncul gerakan khas dalam kalanga saintis barat yang dikenali sebagai 'Intelligent Design' yang mempertikaikan teori evolusi Darwin tersebut. (Al-Najjar, 2021; Azmi, 2016, 2019; Discovery Institute, 2008; Lo et al., 2020; A. M. C. J. McGrath, 2007; Meyer, 2021)

Pertembungan antara sains dengan agama hakikatnya adalah pernyataan hiperbola kerana hanya beberapa teori sains moden sahaja yang bertentangan dengan perkhabaran wahyu seperti teori evolusi Darwin. Kebanyakan teori sains pula bersifat zanni yang rajih dan tidak didustakan oleh wahyu bahkan memang dibiarkan autoritinya kepada capaian pancaindera dan taakulan akal. Terdapat penemuan-penemuan sains yang banyak juga yang selari dengan pemberitahuan wahyu seperti proses kejadian janin manusia. Maka membuat satu kenyataan umum seolah-olah sains keseluruhannya menentang agama adalah tidak tepat sama seperti kritikan Ibnu Taymiyyah terhadap kenyataan akal bertentangan dengan naqal, sedangkan bukan semua dalil 'aqli dan naqli begitu, hanya beberapa isu terpencil.

Demikian juga menerusi rumusan Ibnu Taymiyyah bahawa agama itu bersifat rasional, menolak asas yang dibina atasnya sangkaan pertembungan sains dengan wahyu iaitu wahyu atau agama itu bersifat tidak rasional dan bukan berteraskan bukti empirik, hanya bersifat menerima dan percaya semata-mata (Brooke, 2014; E. A. McGrath, 2010; Stenger, 2012). Asas ini hakikatnya adalah asas yang sama digunakan untuk membina percanggahan 'aqli-naqli. Hakikatnya, Islam dengan jelas menggalakkan kajian akal dan pancaindera dan Al-Quran pula sentiasa menegaskan bukti-bukti Tauhid dengan galakkan dan suruhan memerhatikan kejadian alam, sekali gus, menangkis sangkaan adanya dikotomi antara sains dengan wahyu dan agama.

Epistemologi Ibnu Taymiyyah yang memartabatkan kajian pancaindera atau empirik sebagai asas capaian ilmu tanpa mengira ianya ilmu naqli atau 'aqli menutup sebarang rekahan antara sains dengan agama. Kesatuan metodologi menjamin ketiadaan langsung pertembungan antara dua lapangan ini dan sudut pandang ini tentu berbeza sekali dengan mereka yang mendakwa ada pertembungan yang sering beralasan perbezaan metodologi sebagai asas dakwaan mereka. (Azmi, 2016, 2019)

Kesatuan sumber pengetahuan ini membawa kepada keharmonian di antara sebab fizikal dan sebab maknawi bagi sesuatu fenomena. Antara contoh praktikal bagi perkara ini adalah penjelasan Ibnu Taymiyyah berkenaan kejadian guruh dan kilat bahawa tiada percanggahan di antara apa yang datang dalam hadis Nabi sallallahu 'alaihi wa sallam ianya adalah hasil perbuatan Malaikat dengan apa yang dapat dicapai pancaindera ia terhasil daripada pertembungan jirim awan, kedua-dua sebab fizikal dan sebab maknawi atau ghaib mempunyai keseragaman dan keharmonian bukan saling menafikan antara satu sama lain. (Al-Tamimi, 2021; Azmi, 2019)

SEBAB-AKIBAT MENURUT IBNU TAYMIYYAH DAN APLIKASINYA DALAM FALSAFAH SAINS ISLAM

Hukum sebab-akibat (kausaliti) menurut Ibnu Taymiyyah merupakan lanjutan wacananya berdasarkan Al-Quran, Al-Sunnah dan pegangan jumhur ulama Islam iaitu menetapkan sebab dan musabab. Secara asasnya Allah menciptakan perbuatan hamba (*af'al al-'ibad*) yang mempunyai perkaitannya dengan perbuatan Allah SWT (*af'al Allah*). Ibnu Taimiyyah mengemukakan pandangannya dengan mengatakan bahawa jumhur Ahli Sunnah wal Jamaah berkeyakinan bahawa manusia melakukan perbuatannya secara hakiki. Manusia memiliki kudrat dan daya kemampuan yang hakiki. Ahli Sunnah tidak menafikan kesan yang terjadi

daripada sebab-sebab tabii. Mereka percaya apa-apa yang ditunjukkan oleh syarak dan logik akal. Allah SWT menjadikan awan dan angin, menurunkan hujan melalui awan dan menumbuhkan tanaman dengan air. Mereka meyakini bahawa kekuatan dan tabiat yang terdapat pada makhluk itu mempunyai kesan. (Ibn Taymiyyah, 1986)

Menurut Ibnu Taymiyyah sebagaimana dinyatakannya dalam *Al-Tadmuriyyah* (Al-Barrak, 2011) Ahli Sunnah wal Jamaah beriman bahawa Allah SWT mencipta segala sesuatu, Dialah Tuan dan PemilikNya, apa yang Allah kehendaki pasti terjadi dan apa yang tidak dikehendakinya tidak akan berlaku. Allah SWT Maha Berkuasa di atas segala sesuatu. IlmuNya meliputi segala sesuatu, semuanya telah termaktub dalam Loh Mahfuz (*Kitab Mubin*). Asas dalam menetapkan sebab ini menurut beliau adalah berlegar kepada menetapkan ilmu Allah, kudratNya, kehendakNya (*masyi'ah*), keesaanNya (*wahdaniyyah*) dan apa yang menjadi usul iman. Bersama dengan keyakinan teguh mereka terhadap keesaan Allah, mereka tidak mengingkari sebab-sebab yang diciptakan Allah SWT. Ibnu Taymiyyah mengemukakan tiga ayat yang menetapkan adanya sebab dan perbuatan Allah itu juga berkait dengan penciptaan sebab.

Firman Allah SWT yang bermaksud: *“Dan Dia lah (Allah) yang menghantarkan angin sebagai pembawa berita yang menggembirakan sebelum kedatangan rahmatnya (iaitu hujan), hingga apabila angin itu membawa awan mendung, Kami halakan dia ke negeri yang mati (daerah yang kering kontang), lalu Kami turunkan hujan dengan awan itu, kemudian Kami keluarkan dengan air hujan itu berbagai-bagai jenis buah-buahan..”* (Surah Al-‘Araf:57)

Firman Allah SWT yang bermaksud: *“Dengan (Al-Quran) itu Allah menunjukkan jalan-jalan keselamatan serta kesejahteraan kepada sesiapa yang mengikut keredaanNya, dan (dengannya) Tuhan keluarkan mereka dari gelap-gelita (kufur) kepada cahaya (iman) yang terang-benderang, dengan izinNya, dan (dengannya juga) Tuhan menunjukkan mereka ke jalan yang lurus”* (Surah Al-Ma’idah:16)

Firman Allah SWT yang bermaksud: *“Tuhan akan menjadikan banyak orang sesat dengan sebab perbandingan itu, dan akan menjadikan banyak orang mendapat petunjuk dengan sebabnya.”* (Surah Al-Baqarah:26)

Berdasarkan ayat-ayat yang dikemukakan, boleh didapati Ibnu Taymiyyah melihat sebab terbahagi kepada dua jenis, yang pertama sebab *Kauni* dan kedua sebab *Syarak*. Sebab *Kauni* seperti penurunan hujan melalui awan, penumbuhan tanaman melalui air. Menurut Ibnu Taymiyyah, huruf *“ba”* dalam ayat 57 surah Al-‘Araf itu membawa maksud sebab (*sababiyyah*). Sebab-sebab *Syarak* pula boleh ditinjau dengan melihat kepada penyesatan (*al-idlal*), hidayah petunjuk dengan Al-Quran sebagaimana yang termaktub dalam ayat 26 surah Al-Baqarah. Al-Quran pada zatnya adalah kebaikan, rahmat dan petunjuk. Boleh jadi ia bermanfaat dan boleh juga memudaratkan bergantung kepada sebab-sebab luaran dan pengabaian jalan yang benar dalam mengambil manfaatnya. Al-Quran boleh menjadi sebab hidayah bagi sesiapa yang dikehendaki Allah agar ia mendapat hidayah petunjuknya untuk beramal dengan sebab serta tuntutanNya. Al-Quran juga boleh menjadi sebab kepada kesesatan bagi sesiapa yang dikehendaki oleh Allah untuk menyesatkannya iaitu bagi mereka yang mendustakannya dan berpaling dari mengamalkannya. (Al-Barrak, 2011)

Perbuatan manusia terbahagi kepada dua bahagian, iaitu perbuatan *idtirariyyah* dan perbuatan *ikhtiyariyyah*. Perbuatan manusia yang terpaksa atau teragah seperti seorang yang terjatuh, terlupa sehingga termakan pada waktu siang bulan Ramadan merupakan perbuatan yang bukan pilihan manusia itu sendiri. Manakala perbuatan *ikhtiyariyyah* pula adalah tindakan

yang dipilih sendiri oleh manusia, dilakukan dengan kehendak, upaya dan pilihan akal yang pasti seperti dalam menentukan sesuatu kerja seperti membuat makanan, kediaman dan sebagainya. ((Sahad, 2019))

Menurut Ibnu Taymiyyah juga golongan menafikan sebab telah menyelisih Al-Quran dan pancaindera (*al-hiss*), dan turut mengingkari penciptaan Allah akan kekuatan dan keupayaan tabii (*Al-Tabaa'i*) dan ia seperti mengingkari penciptaan Allah terhadap kudrat dan keupayaan yang ada pada haiwan, dan ia sama seperti menafikan kudrat hamba. Pendapat beliau dalam isu sebab adalah pertengahan di antara dua golongan, iaitu antara pendapat golongan *Qadariyyah* yang menetapkan sebab itu dengan sendirinya memberi kesan secara tabii, lalu mengeluarkan perbuatan makhluk dari penciptaan Allah, dan mendakwa makhluk sendiri mencipta perbuatannya. Golongan berikutnya iaitu golongan pelampau (*ghulat*) Jabariyyah yang mengingkari dan menafikan sebab, iaitu dengan menafikan kesan (*ta'thir*) sebab-sebab serta turut menafikan perbuatan makhluk, kehendaknya dan pilihannya.

Punca yang menyebabkan golongan yang menafikan kesan sebab terjerumus dalam kesalahan itu dikemukakan oleh Ibnu Taymiyyah adalah berpunca dari pentafsiran pada huruf “ba” yang terdapat pada ayat-ayat Al-Quran yang menjelaskan tentang sebab, mereka mentafsirkan “ba” dengan *Al-Musahabah* bukan *Al-Sababiyyah*. Ayat-ayat yang mengandungi “*Lam Al-Ta'li*” menurut mereka pula ditafsirkan dengan maksud *Al-'Aqibah* dan *Al-Sayrurah* yang menatijahkan golongan yang menafikan kesan sebab turut terjebak dalam penafian terhadap hikmah Allah. Kesalahan golongan ini turut dibantah oleh Ibnu Taymiyyah.

Ibnu Taymiyyah juga menegaskan bahawa Allah SWT yang menciptakan sebab dan musabab, sebab tidak berlaku dengan bersendirinya, ia mesti berhajatkan bantuan sebab-sebab yang lain. Sebab juga boleh terhalang oleh sebab-sebab lain yang menghalang. Allah SWT yang mencipta seluruh sebab berdasarkan kehendak dan kudratnya seperti mana Dia mencipta seluruh makhluk. Kudrat makhluk adalah sebab dari sekalian sebab yang diciptakan Allah, perbuatan hamba tidak boleh berlaku dengan sendirinya. Ia mesti didahului dan diiringi oleh kehendak bersama dengan kudrat. Apabila seorang insan sudah berkehendak dan memiliki kudrat untuk melakukan sesuatu perkara, dia perlu pastikan pula segala ikatan dan halangan atau rintangan yang dapat menghalangnya untuk sampai kepada matlamatnya itu dapat dihilangkan. (Ibn Taymiyya, 2005)

Dapat difahami bahawa Ibnu Taymiyyah menetapkan adanya kesan kudrat hamba pada perbutannya. Ia sama seperti kesan sebab kepada akibat, kesan kudrat hamba pada perbuatannya tidak berbeza sama sekali dengan kesan api pada pembakaran, kesan tongkat pada pukulan dan yang seumpamanya. Dalam mengingkari dakwaan Ahli Kalam yang beranggapan menetapkan dua kudrat dalam perbuatan Allah dan makhluk melazimkan kesyirikan Ibnu Taymiyyah menjelaskan bahawa kudrat makhluk hanyalah sebab dan perantara dalam penciptaan Allah SWT yang mencipta perbuatan dengan kudrat, seperti penciptaan tumbuhan dengan sebab air, penciptaan hujan dengan sebab awan. Penyandaran kesan (*al-ta'thir*) ini kepada manusia langsung tidak melazimkan pentafsiran bagi kudrat hamba itu sebagai kesyirikan dan fatalistik (*al-jabr*), jika tidak sudah tentulah menyandarkan seluruh sebab kepada makhluk itu dikira sebagai kesyirikan dan fatalistik.

Penjelasan Ibnu Taymiyyah ini memberi kita kefahaman bahawa perbahasan dalam isu qadar ini iaitu dari sudut perbuatan hamba (*af'al al-'ibad*) bukanlah keseluruhannya hanya terbatas pada perbahasan perbuatan Allah (*af'al Allah*) dan kekuasaanNya semata-mata. Hakikatnya perbahasan topik ini merupakan perbahasan *wujudi*, iaitu perbahasan berkaitan

setiap sebab yang wujud di alam ini antaranya termasuklah keupayaan makhluk (Al-'Umairi, 2019)

Justeru jelas dapat dilihat betapa relevannya wacana Ibnu Taymiyyah dalam topik hukum sebab-akibat ini dalam mengharmonikan antara hukum agama dan sains serta tidak mengengapikan peranan kedua-duanya dalam kehidupan. Menerusi pendekatan Ibnu Taymiyyah ini, kepercayaan terhadap sebab-akibat tidak melunturkan sama sekali keimanan terhadap kekuasaan Allah 'azza wa jalla bahkan setiap kejadian dalam 'alam ini berlaku menurut kehendak kauni Allah dan ditetapkan-Nya dengan Dia meletakkan sistem sebab-akibat yang berada di bawah kawalan dan seliaan-Nya.

KESIMPULAN DAN PENUTUP

Berdasarkan dapatan kajian ini, para pengkaji dapat menyimpulkan isu ini bahawa pendekatan Ibnu Taymiyyah dalam kerangka teori hubungan 'aqli-naqli dan hukum sebab-akibat bersifat saksama dan wasatiyyah, memberikan kedudukan yang sewajarnya kepada akal dan wahyu, kajian sains dan wahyu, tidak menafikan autoriti mana-mana pihak.

Pendekatan Ibnu Taymiyyah yang mengiktiraf kepelbagaian sumber ilmu yang membawa kepada keharmonian sumber-sumber ini membolehkan satu hubungan harmoni antara sains dengan agama diwujudkan. Persoalan seperti undang-undang alam berkaitan sebab-akibat dapat diharmonikan dengan baik dengan kekuasaan Tuhan sebagai pentadbir 'alam dan memberikan perspektif yang lebih harmoni antara sains dengan agama.

Walaupun sudah terdapat pelbagai pendekatan ulama Islam yang lain digunakan dalam pembinaan Falsafah Sains Islam, namun kritikan dan ulasan Ibnu Taymiyyah perlu diberi perhatian sewajarnya dalam menilai pandangan-pandangan ulama Islam yang lain bagi membolehkan kita membentuk kerangka teori yang lebih utuh dan konklusif.

Para pengkaji mencadangkan satu kajian yang lebih luas dilakukan berkaitan pandangan epistemologi dan ontologi Ibnu Taymiyyah untuk membina falsafah sains Islam yang lebih menyeluruh dibandingkan dengan ahli falsafah dan ahli Kalam Islam yang lain. Mengengapikan kritikan dan ulasan Ibnu Taymiyyah dalam isu-isu falsafah dan teologi akan mencacatkan kajian dan menjadikannya tidak mendapat sudut pandang yang menyeluruh.

Pengkaji percaya, kajian ini membuka satu ruang yang lebih luas untuk para pengkaji khususnya dalam bidang falsafah sains menambah pilihan modul dan kerangka teori mereka dalam usaha Islamisasi Sains. *Wallahualam.*

RUJUKAN

- Ahmad, B. (2008). *Falsafah Sains Dari Perspektif Islam* (2nd ed.). Dewan Bahasa dan Pustaka.
- Ahmed Malik, S. (2021). *Islam and Evolution; Al-Ghazālī and the Modern Evolutionary Paradigm*. Routledge.
- Al-Attas, N. S. M. (1989). *Islam and The Philosophy of Science* (1st ed.). ISTAC.
- Al-Barrak, A. R. (2011). *Sharh Al-'Aqidah Al-Tadmuriyyah* (A. R. bin S. Al-Sudais, Ed.; 1st ed.). Dar Al-Tadmuriyah.
- Al-Fifi, A. D. (2021). *Taqrib Dar` Ta'arud Al-'Aql wa Al-Naql* (1st ed.). Dar Taiba Al-Khadra.
- Al-Jalayand, M. A.-S. (2000). *بن تيمية وقضية التأويل* (5th ed.). Dar Quba`.

- Al-Najjar, A. 'Isom. (2021). *Al-Qira`ah Al-'Ilmawiyah lil Islam: Ahmad Khayry Al-'Amry Annudzajan* (1st ed.). Tabseer li Al-Nashr wa Al-Tawzi'.
- Al-Tamimi, A. A. (2021, April 13). Nazarat li Ibn Taymiyyah fi Al-Tabi'iyat. *Al-Bayan*.
- Al-'Umairi, S. D. (2019). *Al-'Uqud Al-Zahabiyah 'ala Maqasid Al-'Aqida Al-Wasitiyyah* (1st ed., Vol. 2). Dar Madarij.
- 'Alwani, T. J. F. al., (1995). *Ibn Taymiyah wa Islamiyat Al Ma'rifah* (2nd ed.). International Islamic Publishing House.
- Azmi, H. D. (2016). *Al-Tatawwur Al-Muwajjah Bayna Al-'Ilm wa Al-Diin* (2nd ed.). Braheen Center For Research and Studies.
- Azmi, H. D. (2019). *Al-Islam wa Al-'Ilm* (1st ed.). Braheen Centre for Research and Studies.
- Berghout, A. (1433). Islamisation in Modern Sciences: The Way Forward. *Revelation and Science*, 01(03), 21–34.
- Blackburn, S. (2016). *The Oxford Dictionary of Philosophy* (3rd ed.). Oxford University Press.
- Brooke, H. (2014). *Science and Religion: Some Historical Perspectives*. Cambridge University Press.
- Chrisman, M., & Pritchard, D. (2014). *Philosophy for Everyone* (M. P. D. Chrisman, Ed.). Routledge.
- Discovery Institute. (2008). *A Brief History of Discovery Institute | Discovery Institute*. <https://www.discovery.org/f/4441/>
- Dixon, T. (2008). *Science and Religion: A Very Short Introduction* (1st ed.). Oxford University Press.
- El-Tobgui, C. S. (2020). *Ibn Taymiyyah on reason and revelation : a study of Dar' ta'arud al-'aql wa-l-naql*. Brill.
- Griffel, F. (2018). Ibn Taymiyya and his ash'arite opponents on reason and revelation: Similarities, differences, and a vicious circle. *Muslim World*, 108(1), 11–39. <https://doi.org/10.1111/muwo.12228>
- Guessoum, N. (2011). *Islam's Quantum Question: Reconciling Muslim Tradition and Modern Science*. I.B Tauris.
- Harari, Y. N. (2019). *Sapiens*. Vintage Classics.
- Ibn Taymiyya, A. bin A. H. (2005). *Majmu' Al-Fatawa* (A. Al-Baz & 'Amir Al-Jazzar, Eds.; 3rd ed., Vol. 8). Dar Al-Wafa.
- Ibn Taymiyyah, A. bin A. H. (1986). *Minhaj Al-Sunnah Al-Nabawiyya* (M. R. Salim, Ed.; Vol. 3). Muassasah Qurtubah.
- Ibn Taymiyyah, A. bin A. H. (2008). *Dar` Ta'arudh Al-'Aql wa Al-Naql* (M. R. Salim, Ed.; 1st ed., Vol. 4). Dar Al-Fadilah.
- ISLAMIZATION OF KNOWLEDGE General Principles and Work Plan*. (n.d.).
- Lo, T. Y., Chien, P. K., Anderson, E. H., Alston, R. A., & Waltzer, R. P. (2020). *Evolution and Intelligent Design in a nutshell* (First). Discovery Institute Press.
- Madani, R. A. (2016). Islamization of Science. *International Journal of Islamic Thought*, 9. <https://doi.org/10.24035/ijit.9.2016.006>
- McGrath, A. M. C. J. (2007). *The Dawkins Delusion*. InterVarsity Press.
- McGrath, E. A. (2010). *Science and Religion A New Introduction* (2nd ed.). Blackwell.
- Meyer, S. C. (2021). *Return of the God Hypothesis* (1st ed.). Harper Collins.
- Mumtaz Ali, M. (2019). *Islamization of Modern Science and Its Philosophy* (2nd ed.). IIUM Press.
- Rapoport, Y., & Ahmed, S. (2015). *Ibn Taymiyya and His Times*. Oxford University Press.
- Religion and Science (Stanford Encyclopedia of Philosophy)*. (n.d.). Retrieved September 20, 2022, from <https://plato.stanford.edu/entries/religion-science/#BrieHist>
- Sahad, M. N. (2019). *Pemikiran Mengenai Ilahiyyat: Sejarah Perkembangan dan Aliran Akidah* (1st ed.). Dewan Bahasa dan Pustaka.

- Samrin, Y. (2020). *Nazariyyat Ibn Taymiyyah fi Al-Ma'rifa wa Al-Wujud* (1st ed.). Markaz Al-Fikr Al-Gharbiy.
- Stenger, V. J. (2012). *God And The Folly of Faith: The Incompability of Science and Religion*. Prometheus Books.
- Thompson, M. (2013). *Philosophy in A Week* (Revised and Expanded). Hodder and Stoughton.



UNIVERSITI



MALAYSIA

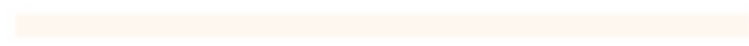

KELANTAN

Stres Dalam Kalangan Pelajar Semasa Pandemik Covid-19: Pengaruh Faktor Emosi Dan Pengurusan Kewangan

Low, Kah Choon

Pusat Pengajian Kerajaan, Universiti Utara Malaysia, Malaysia
Institut Kajian Indonesia, Thailand and Singapura, Universiti Utara Malaysia, Malaysia
kahchoon@uum.edu.my / kclow85uum@gmail.com

Nor Syamila Mohamed

Pusat Pengajian Kerajaan, Universiti Utara Malaysia, Malaysia

ABSTRAK

Kajian ini bertujuan menyelidik stres dalam kalangan pelajar semasa pandemik COVID-19 dengan mengenal pasti hubungan antara faktor emosi dan faktor pengurusan kewangan terhadap tahap stres pelajar. Kajian ini telah dilaksanakan dengan menggunakan kaedah soal selidik yang melibatkan sejumlah 223 responden terdiri daripada pelajar yang tinggal di Inapan Siswa Yayasan al-Bukhary (YAB). Dalam kajian ini, responden telah dipilih secara rawak mudah menggunakan senarai nama dan nombor bilik. Data kajian yang dikutip seterusnya diuji dan dianalisis menggunakan statistik deskriptif dan inferensi. Dapatan kajian menunjukkan bahawa tahap stres dalam kalangan pelajar tahun akhir di Universiti Utara Malaysia adalah berada di tahap yang tinggi. Hasil kajian juga menunjukkan hubungan korelasi antara faktor emosi dan tahap stres pelajar tahun akhir di Universiti Utara Malaysia adalah positif pada tahap sederhana ($r=0.505$). Seterusnya, hubungan korelasi antara faktor pengurusan kewangan dan tahap stres pelajar tahun akhir di Universiti Utara Malaysia adalah positif pada tahap lemah ($r=0.277$). Dapatan kajian menyumbang kepada hubungan yang signifikan antara kedua-dua faktor yang dikaji bagi memastikan kestabilan emosi pelajar dijaga dan daya tindak pelajar berada dalam keadaan yang baik serta memahami kepentingan menjaga kesihatan mental yang baik.

Kata Kunci: *Stres; Emosi; Pengurusan Kewangan; Pelajar, Pandemik COVID-19*

PENDAHULUAN

Stres atau tekanan adalah tindak balas fizikal, emosi dan mental seseorang terhadap perubahan atau tuntutan. Sebagai manusia biasa, pastinya setiap daripada kita pernah merasai pengalaman tertekan atau stres dalam kehidupan seharian. Isu stres ini seharusnya dikenal pasti dan perlu dikawal pada tahap yang lebih awal bagi mengelakkan perkara yang tidak diinginkan berlaku. Sama ada kita suka atau tidak, kita perlu berhadapan dengan situasi tertentu yang boleh menyebabkan tekanan hampir setiap hari.

Pelajar hari ini lebih cenderung daripada remaja dahulu menghadapi tekanan. Di United Kingdom, misalnya, terdapat peningkatan dalam bilangan remaja yang memerlukan bantuan dalam menangani tekanan. Pada fasa akhir remaja antara 1980 dan 1993, bilangan remaja yang mengalami tekanan psikologi (keimbangan, kemurungan, dan gangguan makan) meningkat dengan ketara (McNamara, 2000).

Manakala di Malaysia pula, Kementerian Kesihatan Malaysia (KKM) menunjukkan satu daripada tiga rakyat Malaysia mengalami gangguan mental. Menurut angka tersebut, 20 hingga 30 orang daripada setiap 100,000 orang membunuh diri setiap tahun. Bilangan orang yang mendapatkan rawatan untuk masalah kesihatan mental di hospital kerajaan meningkat sebanyak 15.6 peratus, atau 400,227 pesakit, pada 2008 berbanding 346,196 pesakit pada

2017. Ini menggambarkan bagaimana keadaan kesihatan mental dalam masyarakat moden semakin merosot. Malah, statistik mencatatkan pelajar tidak terlepas daripada mengalami gangguan mental terutamanya mereka yang berumur 16 tahun hingga 19 tahun antara paling ramai mengalami masalah stres. Statistik itu membabitkan individu yang berumur 16 tahun dengan purata iaitu merangkumi 4.2 juta penduduk daripada lebih 31 juta rakyat Malaysia yang mengalami gangguan mental (Subramaniam, 2016).

Dalam persekitaran kampus baharu, pelajar universiti menghadapi pelbagai cabaran yang boleh memberi kesan kepada kesejahteraan psikososial dan keputusan akademik mereka. Ini adalah kerana proses peralihan hidup mereka di universiti, pelajar universiti amat terdedah kepada tekanan pada awal tahun persekolahan (Towbes & Cohen, 1996), lebih-lebih lagi semasa pandemik COVID-19. Pandemik COVID-19 ini telah mengubah landskap universiti dan ia memberikan suatu cabaran kepada generasi yang baru memasuki menara gading. Semasa dalam pandemik COVID-19, golongan mahasiswa tidak dapat dielakkan daripada isu stres kerana mereka sentiasa berdepan dengan pelbagai cabaran di alam kampus. Hal ini demikian kerana universiti merupakan persekitaran unik yang sering kali menuntut pelajar mengimbangkan pelbagai tugas yang perlu dilaksanakan oleh mereka. Sekiranya tidak berjaya, mereka akan mudah mengalami stres.

Kegagalan menguruskan emosi akan menyebabkan stres kepada pelajar tersebut. Pelajar yang banyak dibebani tugas dari pensyarah merupakan satu contoh stres yang baik. Ini kerana pelajar tersebut akan fokus dan belajar untuk menyiapkan tugas tersebut tanpa mengganggu kehidupan sehariannya. Bahkan hasil kerja yang baik akan memberikan kelebihan berganda kepada mereka. Tanpa tekanan yang positif, kebarangkalian pelajar tidak akan mampu menyiapkan tugas yang diberikan pada masa yang telah ditetapkan. Namun ia berbeza apabila pelajar yang banyak dibebani tugas menyebabkan pelajar mengalami tekanan emosi kerana tidak dapat mengawal tekanan tersebut menyebabkan kehidupan menjadi lebih teruk dan tidak teratur.

Selain itu, stres dalam kalangan pelajar juga disebabkan oleh masalah kewangan semasa pandemik COVID-19 melanda. Hal ini demikian kerana sumber kewangan merupakan aset penting bagi seseorang pelajar dalam menuntut ilmu dan melanjutkan pengajian mereka. Wang diperlukan untuk pembayaran yuran, keperluan pengajian yang selesa dan sempurna serta kos sara hidup diri pelajar semasa pandemik melanda dunia. Tambahan pula, pada musim pandemik ini lebih banyak pengeluaran wang yang digunakan terutamanya terhadap pelajar itu sendiri untuk menampung keperluannya dalam pelajaran dan juga keluarga secara tidak langsung. Kesempitan wang yang dialami oleh pelajar boleh menyebabkan mereka berasa tertekan.

Begitulah senario yang akan berlaku sekiranya pelajar tidak dapat menyesuaikan diri dengan perubahan ketara yang berlaku apabila mereka mendaftar di IPTA yang memerlukan pembelajaran yang bersungguh-sungguh untuk mencapai keputusan peperiksaan yang cemerlang di samping menggalas tanggungjawab sebagai anak yang diharapkan untuk membantu ibu bapa dalam membiayai kos hidup keluarga. Pelajar akan menghadapi banyak tekanan untuk mencapai matlamat mereka kerana persaingan yang sengit untuk kecemerlangan akademik dalam suasana pandemik COVID-19 serta harapan ibu bapa.

Maka, kajian ini cuba untuk merungkai permasalahan ini dengan mengenal pasti tahap stres pelajar tahun akhir di Universiti Utara Malaysia (UUM) dan mengkaji pengaruh faktor emosi serta faktor pengurusan kewangan terhadap tahap stres mereka. Kajian ini adalah

penting untuk memahami faktor-faktor penyebab stres bagi tujuan kesedaran serta hasil kajian digunakan oleh pihak pentadbiran universiti, khususnya pihak Hal Ehwal Pelajar untuk inisiatif pemantauan sekali gus menjamin tahap pengurusan stres dalam kalangan pelajar ke arah yang lebih optimistik.

REKA BENTUK KAJIAN

Dalam kajian ini, pemboleh ubah tidak bersandar adalah faktor emosi dan faktor pengurusan kewangan. Manakala pemboleh ubah bersandar adalah tahap stres. Kajian ini difokuskan untuk meneliti tahap stres serta mengkaji pengaruh kedua-dua faktor pemboleh ubah tidak bersandar dengan pemboleh ubah bersandar seperti dalam Rajah 1.

Rajah 1. Kerangka Penyelidikan

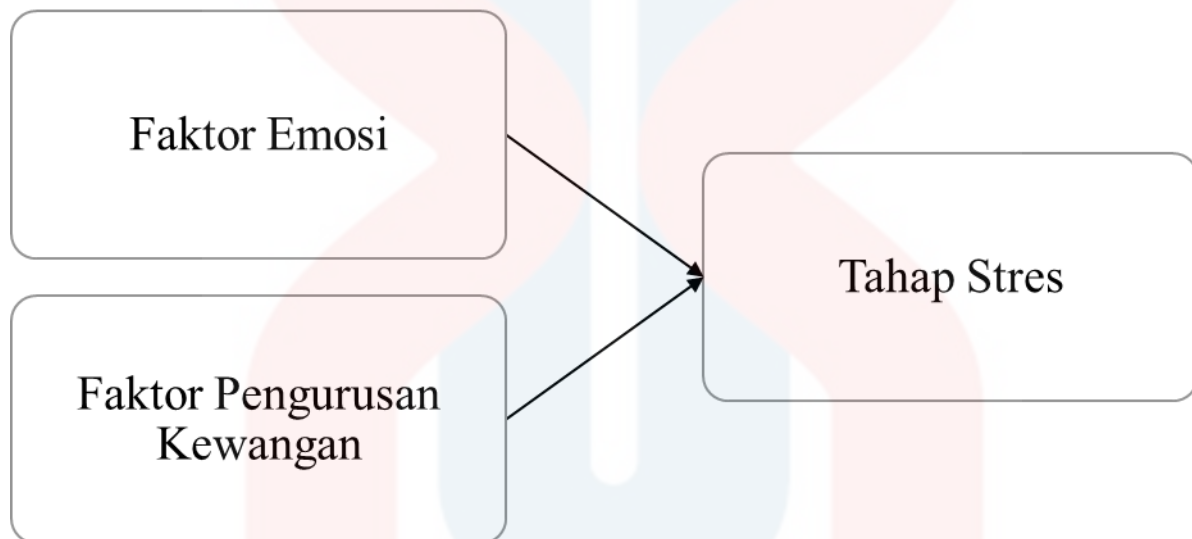

Kajian ini menggunakan pendekatan kuantitatif secara kaedah tinjauan bagi mengukur tahap stres dalam kalangan pelajar universiti tahun akhir. Instrumen soal selidik pula dilaksanakan dan dijalankan bagi tujuan memperoleh maklumat daripada responden. Kajian ini menggunakan kaedah pensampelan rawak mudah dan penentuan saiz sampel dibuat dengan merujuk kepada jadual Krejcie dan Morgan (1970).

Tempat kajian umum adalah di UUM. Penyelidik ingin mengkaji sejauh mana tahap stres di kalangan pelajar tahun akhir UUM. Populasi kajian merupakan semua pelajar tahun akhir UUM. Pemilihan sampel ini dilakukan dengan menyenaraikan semua Inasis di UUM yang terdiri daripada (1) MAS, (2) TNB, (3) TRADEWINDS, (4) PROTON, (5) PETRONAS, (6) SIME DARBY, (7) TM, (8) GRANTT, (9) MISC, (10) BSN, (11) YAB, (12) MUAMALAT, (13) BANK RAKYAT, (14) SME BANK dan (15) MAYBANK. Kemudian nama-nama Inasis disenaraikan dalam 15 keping kertas kecil. Kertas-kertas kecil ini dimasukkan ke dalam sebuah kotak. Kotak tersebut digoncang dan satu keping kertas kecil dicabut. Nama Inasis yang terdapat pada kepingan kertas kecil itu dijadikan sebagai sampel kajian. Hasil cabutan merupakan Inasis YAB. Jumlah nama di YAB berjumlah 535 orang dan saiz sampel yang dicadangkan oleh Krejcie dan Morgan (1970) adalah 223 responden.

Responden akan diberi borang soal selidik yang mengandungi empat bahagian utama iaitu bahagian A, B, C, dan D. Bahagian A merupakan soalan yang merangkumi data demografi responden seperti jantina, umur, bangsa, tempat tinggal, dan kolej pengajian. Manakala bahagian B terdiri daripada sepuluh item soalan yang menggambarkan tahap stres terhadap

pelajar universiti. Bahagian C pula merangkumi set soalan mengenai aspek yang menghubungkan masalah emosi dan tahap stres pelajar. Akhir sekali, bagi bahagian D pula, terdiri daripada sembilan soalan yang merangkumi masalah kewangan dan tahap stres pelajar. Pengkaji telah memberi masa yang cukup kepada responden untuk mengisi borang soal selidik. Pengkaji juga telah memberi penerangan ringkas sebelum mengedarkan borang soal selidik dan kesemua responden telah memberi kerjasama yang amat baik.

Responden perlu mengisi borang soal selidik pada hari yang sama ianya diedarkan. Hal ini dilakukan agar borang yang diberikan dapat dikembalikan semula. Dalam mengisi borang soal selidik ini, tiada had masa diberikan kepada responden. Ini kerana jumlah masa yang ditetapkan dalam mengisi borang soal selidik membuatkan responden tidak dapat memberikan jawapan yang terbaik. Setiap borang soal selidik ditandakan dengan nombor mengikut turutan bagi memastikan tidak berlaku sebarang kesilapan semasa merekodkan data. Kemudian, jawapan borang soal selidik yang dikumpul dimasukkan ke dalam data statistik yang telah ditetapkan.

DAPATAN KAJIAN

Analisis Deskriptif (Demografi Kajian)

Secara keseluruhannya, aspek analisis deskriptif responden merangkumi aspek jantina, umur, bangsa, tempat tinggal dan kolej pengajian pelajar yang belajar di Universiti Utara Malaysia (UUM). Secara keseluruhannya, analisis deskriptif ini dapat digambarkan dalam Jadual 1 dalam bentuk peratusan dan kekerapan berdasarkan soalan soal selidik.

Jadual 1. Profil Demografi

Item	Frekuensi	Peratusan (%)
Jantina		
Lelaki	107	48.0
Perempuan	116	52.0
Umur		
20 – 21 tahun	63	28.3
22 – 23 tahun	89	39.9
24 – 25 tahun	71	31.8
Bangsa		
Melayu	65	29.1
Cina	58	26.0
India	73	32.7
Lain-lain	27	12.1
Tempat Tinggal		
Luar bandar	107	48.0
Bandar	116	52.0
Kolej Pengajian		
COB	89	39.9
COLGIS	100	44.8
CAS	34	15.2

Analisis Taburan Data

Analisis taburan data dijalankan untuk memastikan andaian normaliti bagi kesemua pemboleh ubah. Jadual 2 memaparkan skor deskriptif bagi kesemua pemboleh ubah berdasarkan 223 responden yang telah diperolehi. Jadual ini juga menunjukkan nilai *skewness* dan *kurtosis* untuk setiap pemboleh ubah dalam penyelidikan ini. Daripada Jadual 2, nilai *skewness* untuk ketiga-tiga pemboleh ubah adalah diantara -0.902 dan -0.346. Secara amnya, nilai *skewness* antara -1 dan +1 adalah diklasifikasikan sebagai taburan normal dan diterima untuk menjalankan ujian parametrik yang sesuai. Sementara itu, George & Mallery (2010) menyatakan bahawa nilai *skewness* dan *kurtosis* di antara -2 dan +2 adalah dianggap diterima untuk membuktikan taburan univariat yang normal. Kesimpulannya, skor taburan tidak tersasar daripada anggapan normaliti disebabkan nilai *skewness* untuk keseluruhan pemboleh ubah adalah dalam kalangan -1.0 dan +1.0. Memandangkan semua data adalah normal, maka andaian yang dibuat bagi menggunakan ujian parametrik untuk analisis selanjutnya boleh diteruskan.

Jadual 2. Statistik Deskriptif untuk Kesemua Pemboleh Ubah

Pemboleh Ubah	Jumlah Sampel	Skor Minimum	Skor Maksimum	Skewness	Kurtosis
Stres	223	1.60	4.60	-0.793	0.508
Emosi	223	1.50	4.60	-0.902	0.539
Masalah Kewangan	223	2.11	4.44	-0.346	0.170

Analisis Min

Antara objektif penyelidikan ini adalah untuk mengkaji tahap stres pelajar tahun akhir di Universiti Utara Malaysia. Analisis min telah dijalankan untuk melihat tahap stres pelajar tahun akhir di Universiti Utara Malaysia. Dengan nilai min melebihi 3.0 menunjukkan bahawa tahap stres dalam kalangan pelajar tahun akhir di Universiti Utara Malaysia adalah berada di tahap yang tinggi (min= 3.3776, SP= 0.43953).

Jadual 3. Tahap Stres

Item	Jumlah Sampel	Min	Sisihan Piawai (SP)
Stres	223	3.3776	0.43953
Emosi	223	3.4049	0.45661
Masalah Kewangan	223	3.4624	0.38535

Analisis Korelasi

Korelasi secara umumnya menerangkan kesan bahawa dua atau lebih fenomena berlaku bersama-sama dan oleh itu ia dikaitkan. Nilai korelasi adalah daripada -1.00 hingga +1.00. Antara objektif kajian ini adalah ingin mengenal pasti hubungan antara faktor emosi dan tahap stres pelajar dan juga ingin mengenal pasti hubungan antara faktor pengurusan kewangan dan tahap stres tahun akhir di Universiti Utara Malaysia. Bagi mencapai objektif kajian ini, analisis ujian Korelasi Pearson telah dilakukan untuk memeriksa sama ada terdapat hubungan antara

emosi dan masalah kewangan dengan tahap stres. Penyelidikan ini dijalankan menggunakan panduan yang dicadangkan Evans (1996) untuk mendapatkan nilai *rs* seperti dalam Jadual 4.

Jadual 4. Tahap Koefisien Korelasi Pearson

Koefisien Korelasi Pearson (<i>rs</i>)	Nilai Korelasi
0.00 - 0.19	Sangat Lemah
0.20 - 0.39	Lemah
0.40 - 0.59	Sederhana
0.60 - 0.79	Kuat
0.80 - 1.00	Sangat Kuat

Sumber: Adaptasi daripada Evans (1996)

Hipotesis 1

H1: Terdapat hubungan yang signifikan di antara faktor emosi dan tahap stres pelajar tahun akhir di Universiti Utara Malaysia.

Berdasarkan Jadual 5, dapat disimpulkan bahawa terdapatnya hubungan yang signifikan di antara faktor emosi dan tahap stres pelajar tahun akhir di Universiti Utara Malaysia. Hal ini berdasarkan nilai *p-value* antara dua pemboleh ubah iaitu emosi dengan tahap stres adalah signifikan berdasarkan nilai *p-value* = 0.000 adalah lebih rendah daripada $\alpha = 0.05$. Oleh itu, H1 gagal ditolak dan membuktikan bahawa terdapat hubungan yang signifikan antara faktor emosi dan tahap stres pelajar tahun akhir di Universiti Utara Malaysia. Berpandukan kepada Jadual Korelasi yang diusulkan oleh Evans (1996), hubungan korelasi antara faktor emosi dan tahap stres pelajar tahun akhir di Universiti Utara Malaysia adalah positif pada tahap sederhana ($r=0.505$). Kesimpulannya, terdapat hubungan yang positif dengan tahap sederhana antara faktor emosi dan tahap stres pelajar tahun akhir di Universiti Utara Malaysia.

Jadual 5. Korelasi Antara Emosi Dan Tahap Stres

		Stres
Emosi	Pearson Correlation	0.505
	Sig. (2-tailed)	0.000
	N	223

Hipotesis 2

H2: Terdapat hubungan yang signifikan di antara faktor pengurusan kewangan dan tahap stres pelajar tahun akhir di Universiti Utara Malaysia.

Berdasarkan Jadual 6, dapat disimpulkan bahawa terdapatnya hubungan antara faktor pengurusan kewangan dan tahap stres pelajar tahun akhir di Universiti Utara Malaysia. Hal ini berdasarkan nilai Korelasi Pearson antara dua pemboleh ubah iaitu pengurusan kewangan dan tahap stres adalah signifikan iaitu $p = 0.000$ lebih rendah daripada $\alpha = 0.05$. Oleh itu, H2 gagal ditolak dan membuktikan bahawa terdapat hubungan yang signifikan antara faktor pengurusan kewangan dan tahap stres pelajar tahun akhir di Universiti Utara Malaysia. Berpandukan kepada Jadual Korelasi yang diusulkan oleh Evans (1996), hubungan korelasi antara faktor pengurusan kewangan dan tahap stres pelajar tahun akhir di Universiti Utara Malaysia adalah positif pada tahap lemah ($r=0.277$). Oleh yang demikian, terdapat hubungan yang positif dengan tahap lemah antara faktor pengurusan kewangan dan tahap stres pelajar tahun akhir di Universiti Utara Malaysia.

Jadual 6. Korelasi Antara Pengurusan Kewangan Dan Tahap Stres

		Stres
Pengurusan Kewangan	Pearson Correlation	0.277
	Sig. (2-tailed)	0.000
	N	223

PERBINCANGAN

Berdasarkan dapatan kajian, terdapat konsistensi daripada segi dapatan kajian penyelidik dengan pengkaji-pengkaji lepas. Dapatan kajian juga menunjukkan bahawa faktor emosi dalam kalangan pelajar merupakan faktor dominan yang menyumbang kepada berlakunya stres dalam kalangan pelajar berbanding dengan faktor pengurusan kewangan. Hasil kajian mencatatkan hubungan signifikan wujud antara faktor emosi dan tahap stres pelajar tahun akhir Universiti Utara Malaysia pada tahap sederhana yang selari dengan kajian yang dilakukan oleh Abdul Aziz et al. (2020). Kesihatan mental boleh menjejaskan cara berfikir, tingkah laku, perasaan dan emosi seseorang. Oleh itu, tahap kesejahteraan mental boleh menjejaskan kebolehan seseorang untuk membuat keputusan yang tepat dalam kehidupan, menyelesaikan masalah serta berinteraksi dengan orang lain. Apabila seseorang mempunyai tahap kesihatan mental yang baik maka dia dapat berfikir secara positif dan tenang untuk menangani segala tekanan hidup yang dilalui. Keadaan stres ini boleh menimbulkan kecelaruan mental dan juga fizikal serta kesan terhadap pencapaian akademik (Plucker, 1997).

Selain itu, hasil kajian berkenaan faktor pengurusan kewangan dan tahap stres pelajar tahun akhir di Universiti Utara Malaysia juga menunjukkan hubungan yang signifikan dengan stres pelajar pada tahap lemah. Oleh itu, hasil kajian telah menerima bahawa faktor pengurusan kewangan juga mampu memberi pengaruh dan juga kesan terhadap stres pelajar dalam meneruskan pembelajarannya terutamanya semasa pandemik COVID-19 ini dan disokong melalui kajian lepas yang telah dilakukan oleh Ramli & Sheikh Dawood (2020).

Hasil analisis kajian ini juga mendapati bahawa pelajar tahun akhir Universiti Utara Malaysia ini mengalami stres pada tahap yang tinggi dan ianya berbeza dengan hasil kajian lain yang mencatatkan tahap sederhana (Daud et al., 2021; Che Bakar & Surat, 2022). Justeru, pelajar perlulah diajar kemahiran berdaya tindak dan juga diberikan sokongan sosial terutamanya daripada ibu bapa, adik-beradik, rakan dan orang sekeliling semasa menghadapi sesuatu masalah supaya mereka terhindar daripada kesan-kesan yang tidak diingini.

KESIMPULAN

Keputusan dan objektif kajian ini telah memberikan satu gambaran yang jelas bahawa pelajar sememangnya dibelenggu oleh masalah stres dalam diri mereka akibat daripada faktor emosi dan juga faktor pengurusan kewangan. Stres yang tinggi boleh memberi kesan yang besar dan mendalam kepada pelajar berkenaan jika tidak diurus dengan baik. Sebagai contoh, pelajar akan lebih suka untuk bersendirian serta membuat perkara-perkara yang menyalahi undang-undang seperti pengambilan minuman keras dan juga pengambilan dadah.

Oleh itu, adalah mustahak bagi pihak universiti untuk merancang dan melaksanakan langkah-langkah atau kaedah alternatif bagi membantu para pelajar yang menghadapi stres ini terutamanya daripada pihak Jabatan Hal Ehwal Pelajar (HEP) dan Pusat Kaunseling. Faktor emosi yang menjadi faktor utama stres perlu diberikan perhatian. Hal ini secara tidak langsung

menyebabkan pelajar yang mengalami stres itu tidak fokus dalam pelajaran serta boleh menyebabkan mereka terdorong untuk gagal dalam sesuatu subjek pengajian yang diambilnya.

Kesimpulannya, stres dalam kalangan pelajar dapat diatasi sekiranya semua pihak bersama-sama dalam menangani masalah stres dalam kalangan pelajar ini. Hal ini seterusnya menunjukkan bahawa dimensi yang diguna pakai dalam kajian ini adalah bersesuaian dan juga ianya perlu diterapkan oleh semua pelajar dan juga orang di sekeliling mahupun organisasi lain dari dalam dan juga luar UUM.

PENGHARGAAN

Kajian ini disokong secara langsung dan tidak langsung oleh pihak Pusat Pengajian Kerajaan, UUM dan Institut Penyelidikan Indonesia, Thailand dan Singapura, UUM dalam menggalakkan kolaborasi strategik antara ahli akademik dan pelajar.

RUJUKAN

- Abdul Aziz, A. R., Shafie, A. A. H., Mohd Soffian Lee, U. H., & Raja Ashaari, R. N. S. (2020). Strategi pembangunan aspek kesejahteraan sendiri bagi mendepani tekanan akademik semasa wabak COVID-19. *Malaysian Journal of Social Sciences and Humanities (MJSSH)*, 5(12), 16 - 30. <https://doi.org/10.47405/mjssh.v5i12.594>
- Che Bakar, W. M. A., & Surat, S. (2022). Stres akademik dan strategi daya tindak dalam kalangan pelajar: Satu kajian sistematik. *Malaysian Journal of Social Sciences and Humanities (MJSSH)*, 7(3), e001330. <https://doi.org/10.47405/mjssh.v7i3.1330>
- Daud, Z., Mohd Haridi, N., Alias, N., & Hasin, A. (2021). Kajian perbandingan kalangan pelajar Institusi Pengajian Tinggi terhadap simptom stres yang dialami ketika sesi pengajaran dan pembelajaran dalam talian era Covid-19. *Al-Irsyad: Journal of Islamic and Contemporary Issues*, 6(1), 615–627. <https://doi.org/10.53840/alirsyad.v6i1.136>
- Evans, R. H. (1996). An analysis of criterion variable reliability in conjoint analysis. *Perceptual and Motor Skills*, 82(3), 988-990. <https://doi.org/10.2466/pms.1996.82.3.9>
- George, D., & Mallery, M. (2010). *SPSS for Windows step by step: A simple guide and reference* (10th ed.). Pearson.
- Krejcie, R. V., & Morgan, D. W. (1970). Determining sample size for research activities. *Educational and Psychological Measurement*, 30(3), 607–610. <https://doi.org/10.1177/001316447003000308>
- McNamara, S. (2000). *Stress in young people: What's new and what can we do?* Continuum.
- Plucker, J. A. (1997). Debunking the myth of the "highly significant" result: Effect sizes in gifted education research. *Roeper Review: A Journal on Gifted Education*, 20(2), 122–126. <https://doi.org/10.1080/02783199709553873>
- Ramli, M. W., & Sheikh Dawood, S. R. (2020). Faktor tekanan dalam kalangan pelajar Universiti Sains Malaysia: Satu tinjauan awal. *Jurnal Sains Sosial dan Kemanusiaan*, 17(7), 66-76.
- Subramaniam, S. (2016, September 28). Masalah kesihatan mental di Malaysia. *Kementerian Kesihatan Malaysia*. https://www.moh.gov.my/index.php/database_stores/attach_download/337/796
- Towbes, L. C., & Cohen, L. H. (1996). Chronic stress in the lives of college students: Scale development and prospective prediction of distress. *Journal of Youth and Adolescence*, 25(2), 199–217. <https://doi.org/10.1007/BF01537344>

Mat Kilau: Kebangkitan Pahlawan (2022) Sebuah Filem Cerminan Ummah

Fatimah Muhd Shukri

Fakulti Teknologi Kreatif dan Warisan, Universiti Malaysia Kelantan
fatimah.s@umk.edu.my

Nur Asfarina Ab Aziz

Fakulti Teknologi Kreatif dan Warisan, Universiti Malaysia Kelantan
asfarina.ab@umk.edu.my

Mohd Saipuddin Suliman

Fakulti Teknologi Kreatif dan Warisan, Universiti Malaysia Kelantan
saipuddin.s@umk.edu.my

ABSTRACT

Mat Kilau: Kebangkitan Pahlawan (MKKP), a movie on the British occupation of Malaya, was shown on June 23, 2022. (2022). After 33 days of showings, this movie generated RM90 million in ticket sales, and it also stoked the nationalism that is prevalent today. This movie highlights the importance of history, nationality, and interethnic unity. Film is a vital tool for spreading ideas in the emerging digital age, as well as for bridging racial communication gaps. However, Malaysia remains unable to produce films that accurately portray its community or ummah. This study seeks an answer to the question, "Does MKKP film represent the oneness of the ummah?". The basic research study with a qualitative research design serves as the foundation for this paper. It is also used to gather information in print and digital form. Digital form data from MKKP films is analysed using content analysis. The five principles of the Theory of Satisfaction and Uses, developed by Katz, Gurevitch, and Haas, are applied in this work to the social and psychological demands that media users must satisfy. Overall, this article finds that MKKP films, whether in the production or filming process or the substance of the film, meet five principles for social and psychological demands that media users need to be addressed. According to the author's opinion, more attention is paid to the cognitive, affective, and social integrative needs among these five needs than to the integrative and stress-reduction needs. Due to the fact that the three wants are examined more thoroughly and have an effect on the audience by being seen by them when they watch in the theatre.

Keywords: *MKKP; Ummah; Nationalism; Race; Theory of Satisfaction and Uses.*

ABSTRAK

Tanggal 23 Jun 2022, masyarakat Malaysia telah disajikan dengan sebuah filem mengenai pendudukan British di Tanah Melayu iaitu filem Mat Kilau: Kebangkitan Pahlawan (MKKP) (2022). Filem ini telah mencetuskan fenomena iaitu dari segi kutipan tiket yang mencecah RM90juta selepas 33 hari tayangan dan telah merangsang semangat nasionalisme. Filem ini memaparkan nilai sejarah, nasionalisme dan perpaduan ummah. Dalam pembangunan era digital, filem memainkan peranan penting dalam menyampaikan mesej dan sebagai medium hubungan bagi merapatkan jurang antara kaum. Namun begitu, filem Malaysia yang mencerminkan ummah atau masyarakat Malaysia masih kurang dihasilkan di Malaysia. Sehubungan dengan itu, timbulnya satu persoalan yang ingin dijawab dalam makalah ini iaitu, adakah filem MKKP memaparkan aspek perpaduan ummah?. Makalah ini bersandarkan kepada kajian penyelidikan asas dengan reka bentuk kajian kualitatif. Kajian perpustakaan turut diaplikasikan bagi mengumpul data dalam bentuk cetakan dan digital. Analisis kandungan diaplikasikan bagi menganalisis data bentuk digital yang diperolehi daripada filem MKKP. Makalah ini menerapkan lima panduan keperluan sosial dan psikologi yang perlu

dipenuhi oleh pengguna media dalam Teori Kepuasan dan Kegunaan yang diperkenalkan oleh Katz, Gurevitch, dan Haas. Secara keseluruhannya, makalah ini merakamkan, lima panduan keperluan sosial dan psikologi yang perlu dipenuhi oleh pengguna media dan didapati terdapat dalam filem MKKP sama ada dalam proses produksi atau penggambaran mahupun kandungan filem tersebut. Berdasarkan penilaian peribadi pemakalah, antara lima keperluan ini, keperluan kognitif, afektif dan integratif sosial diteliti melebihi keperluan integratif dan keperluan mengurangkan tekanan. Hal ini kerana, tiga keperluan tersebut diteliti lebih menyerlah dan memberi impak kepada penonton dengan disaksikan sendiri semasa melakukan penontonan di panggung wayang.

Kata Kunci: MKKP; Ummah; Nasionalisme; Bangsa; Teori Kepuasan dan Kegunaan.

PENGENALAN

Tanggal 23 Jun 2022, masyarakat Malaysia telah disajikan dengan sebuah filem biografi epik mengenai pendudukan British di Tanah Melayu iaitu filem *Mat Kilau: Kebangkitan Pahlawan* (ditulis sebagai MKKP selepas ini) (2022). Filem ini diarahkan oleh Mohd Syamsul bin Mohd Yusof atau lebih dikenali dengan nama Syamsul Yusof. Filem MKKP merupakan filem keluaran Studio Kembara dan Skop Productions Sdn. Bhd. Filem MKKP ini dibintangi oleh beberapa barisan pelakon terkenal antaranya Datuk Adi Putra, Beto Kusyairy, Fattah Amin, Wan Hanafi Su, Datuk Jalaluddin Hassan, Datuk Rahim Razali, Mubarak Majid, Shaharuddin Thamby, Namron, A. Galak, Ellie Suriaty, Khir Rahman dan pelakon Indonesia yang mencipta nama di *Hollywood* iaitu Yayan Ruhian (Bernama, 2022).

Gambar 1: Judul filem MKKP



(sumber: MKKP, 2022)

Filem MKKP telah berjaya menaikkan nama industri perfileman Malaysia. Kejayaan yang membanggakan yang diraih oleh filem ini antaranya adalah kutipan tiket berjumlah RM 97 juta, filem pecah panggung tertinggi bagi kategori filem tempatan dan antarabangsa selepas *Munafik 2* dan *Avengers: End Game* (RM 87 juta kutipan di Malaysia). Selain daripada itu, filem MKKP juga berjaya mendapat kedudukan pertama selama lima minggu berturut-turut dalam carta *box office* Malaysia dan dalam kedudukan carta *Top 10* di hampir 20 buah negara antaranya Singapura, Korea Selatan, Sweden, Romania, Arab Saudi, Oman, Filipina, Finland dan Greece (Zaidi, 2022; Bernama, 2022; Astro Awani, 2022).

Lebih menarik untuk dibincangkan, filem MKKP ini sarat dengan mesej berunsurkan patriotik dan nasionalisme. Antara mesej patriotik yang diangkat dalam kandungan filem MKKP adalah mutiara kata dalam dialog, kepimpinan berkualiti dan ketokohan watak yang tercatat dalam sejarah. Menurut Bilal Jailani seorang Pengkaji Filem, beliau menyatakan bahawa filem *Mat Kilau* telah meniupkan rasa bangga dan patriotisme dalam diri penonton Malaysia menerusi kata-kata mutiara yang diungkapkan dalam dialog yang menusuk kalbu dan

berunsur nasihat (Bilal dalam Bernama, 2022). Menurut Nisah Haron seorang penulis buku dan Sasterawan Muda pula berkata bahawa, filem Mat Kilau memaparkan kepimpinan yang berkualiti (Nisah dalam Bernama, 2022). Seterusnya, Abdul Rahman Dali iaitu penerbit filem MKKP pula menerangkan bahawa filem MKKP bertujuan mengangkat ketokohan watak yang tercatat dalam sejarah (Abdul dalam Bernama, 2022).

Pencapaian dan kandungan filem MKPP telah terbukti dalam memaparkan nilai sejarah, tokoh, nasionalisme dan semangat patriotisme. Selain daripada itu, filem MKKP ditonton oleh segenap lapisan masyarakat tanpa mengira umur, bangsa dan agama. Ini juga menunjukkan bahawa dalam pembangunan era digital, filem bukan sekadar sebuah media hiburan malah, filem bertujuan untuk menyampaikan mesej dan sebagai medium hubungan bagi merapatkan jurang antara kaum apabila ia dikongsi oleh segenap lapisan masyarakat untuk sama-sama menonton filem tersebut. Namun begitu, filem Malaysia yang mencerminkan perpaduan ummah masih kurang dihasilkan di Malaysia. Sehubungan dengan itu, timbulnya satu persoalan, iaitu adakah filem MKKP memaparkan perpaduan ummah?.

Bagi menjawab persoalan di atas, perbincangan lanjut akan diteruskan di bawah dengan meneliti kandungan filem MKKP. Penelitian ini akan bersandarkan kepada Teori Kepuasan dan Kegunaan yang diperkenalkan oleh Katz, Gurevitch, dan Haas. Justeru itu, bagi melaksanakan perbincangan ini, beberapa pecahan topik dan subtopik dilakukan.

KAJIAN KESUSASTERAAN

Kajian kesusasteraan dibahagikan kepada dua subtopik iaitu pengaruh elemen perpaduan dalam pembangunan jati diri dan penyatuan ummah di dalam konteks filem. Sebelum membincangkan dua subtopik ini dengan lebih lanjut, maksud “perpaduan ummah” akan terlebih dahulu diterangkan di sini. Ummah mengikut Leha @ Zaleha (2004) membawa maksud “...semua rakyat yang menjadi warganegara bagi sesebuah negara.” Perpaduan ummah menurut Islam pula membawa maksud “Permuafakatan rakyat pada usaha untuk sama-sama membangun dan mengekalkan keselamatan, kesejahteraan dan kemakmuran negara.” (Leha @ Zaleha, 2004). Justeru itu, ingin kami rumuskan di sini bahawa “perpaduan ummah” yang diertikan di dalam makalah ini adalah komuniti masyarakat Malaysia tanpa mengira kaum, bangsa atau ras yang bersama-sama dalam menjaga keharmonian, keselamatan, kesejahteraan dan kemakmuran negara. Oleh itu, bersandarkan kepada maksud “perpaduan ummah” dalam makalah ini, kajian literatur bagi dua subtopik yang dinyatakan di atas diperincikan di bawah.

Pengaruh Elemen Perpaduan Dalam Pembangunan Jati Diri

Isu keretakan perpaduan dan perkauman di Malaysia bukanlah sesuatu yang baharu untuk diperdebatkan malahan pelbagai usaha telah diambil bagi mengurangkan jurang perselisihan antara ummah. Razid (2017) berpendapat negara Malaysia adalah sebuah negara *heterogeny* (pelbagai) yang terdiri daripada pelbagai jenis etnik, agama, asal usul tetapi melalui perpaduan ianya mampu menyemarakkan kesedaran nasional.

Pembikin filem di Malaysia kini menggunakan filem sebagai salah satu wadah untuk menyampaikan propaganda bersifat semangat patriotik dalam usaha menyatukan masyarakat yang berbilang bangsa. Ini selari dengan cadangan pembikin filem yang menekankan kepentingan keharmonian antara kaum serta sifat simpati sebagai tunjang utama kepada keutuhan bangsa yang terdiri daripada pelbagai budaya dan etnik seperti di Malaysia (Deraman & Razak, 2018). Antara filem yang pernah dihasilkan di Malaysia bertemakan perpaduan

adalah seperti *Paloh* (2003), *Muallaf* (2008), *Talentine* (2009), *Setem* (2009), *Estet* (2010), dan *Ola Bola* (2016).

Filem yang mengintegrasikan elemen perpaduan sebegini bertujuan mendidik rakyat Malaysia untuk hidup secara harmoni di bawah satu bumbung sebagai satu bangsa yang saling melengkapi. Shariff, Sualman & AdiIrawan (2013) pula berpendapat penonton akan terdidik dan termotivasi untuk menerima dan menyesuaikan diri dengan perbezaan bangsa, agama, sentimen politik serta perkauman sekiranya isu sedemikian dikupas di dalam filem.

Elemen perpaduan ini seharusnya mencari titik persamaan antara manusia yang terdiri daripada pelbagai latar belakang dan berbeza kepercayaan. Dari situ akan terhasilnya ummah yang bersatu padu serta mampu hidup dalam suasana harmoni meskipun berbeza dalam pelbagai aspek. Oleh hal yang demikian, makalah ini khusus dalam membincangkan aspek perpaduan ummah dalam kandungan filem MKKP dengan bersandarkan kepada Teori Kepuasan dan Kegunaan.

Penyatuan Ummah di dalam Konteks Filem

Filem merupakan simbol perpaduan yang berpotensi untuk menyatupadukan penonton (Shariff, Sualman & AdiIrawan, 2013). Filem yang memperkenalkan barisan pelakon daripada pelbagai kaum dilihat sebagai salah satu usaha untuk memupuk perpaduan antara kaum berbilang bangsa di Malaysia. Pelakon dan pengarah terkenal Malaysia, Allahyarham Tan Sri P.Ramlee yang terkenal dengan filem beliau yang mencuit hati diangkat sebagai pelopor kepada usaha dalam menyatupadukan pelakon berbilang bangsa seperti kaum Melayu, Cina dan India untuk terlibat sama dalam penghasilan filem di bawah arahan beliau sebagai contoh *Pendekar Bujang Lapok* (1959).

Usaha ini merupakan satu promosi kepada perpaduan nasional khususnya di negara Malaysia. Menurut Adnan (1988), kerajaan Malaysia mulai menilai filem sebagai satu wadah dalam memupuk identiti dan penyatuan nasional. Ini terbukti melalui penghasilan filem yang berkisar kepada elemen perjuangan dan perpaduan yang bukan sekadar berjaya mengutip pulangan yang lumayan malahan meninggalkan kesan yang mendalam terhadap penonton seperti filem MKKP.

Pengarah filem Allahyarham Mamat Khalid turut mencadangkan agar pembikin filem di Malaysia menghasilkan lebih banyak filem berkisarkan isu perkauman (Umi, 2017). Hal ini disebabkan mesej perpaduan kelihatan lebih kritikal dan penonton akan lebih menghargai kepentingan penyatupaduan antara ummah. Ini kerana beliau melihat filem yang bersifat perpaduan semata kurang berjaya menarik minat sesetengah golongan kaum seperti filem arahan Allahyarham Yasmin Ahmad. Kaum Melayu dilihat memprotes kandungan filem arahan beliau seperti *Sepet* (2005) dan *Gubra* (2006) akan tetapi berjaya menarik minat dan perhatian kaum Cina dan India.

Kajian tentang penyatuan ummah telah dilaksanakan oleh sarjana-sarjana terdahulu. Selain daripada itu, konsep perpaduan ummah telahpun disajikan dalam beberapa kandungan filem Malaysia dan telah dipaparkan kepada khalayak. Walau bagaimanapun, filem MKKP merupakan filem yang diterbitkan pada tahun 2022 yang memaparkan tentang perpaduan ummah (kaum Melayu). dan konteks perpaduan ummah dalam filem ini masih belum dibincangkan.

METODOLOGI

Makalah ini bersandarkan kepada kajian jenis penyelidikan asas dengan reka bentuk kajian kualitatif. Kajian kepustakaan turut diaplikasikan bagi menggumpul data sekunder dalam bentuk cetakan seperti buku, tesis, majalah dan akhbar. Manakala dalam bentuk digital pula

seperti artikel digital, akhbar digital, tesis digital dan portal-portal yang mempunyai autoriti. Data primer pula adalah dalam bentuk digital iaitu menerusi kandungan filem MKKP. Analisis kandungan diaplikasikan sebagai instrumen kajian bagi menganalisis kandungan filem MKKP. Analisis kandungan yang dijalankan menerusi filem MKKP adalah bersifat peribadi. Pemakalah yang merupakan salah seorang penonton filem MKKP menjadi individu yang menilai dan menganalisis naratif filem MKKP. Sehubungan dengan itu Teori Kepuasan Dan Kegunaan diaplikasikan berdasarkan pengalaman peribadi pemakalah selepas menonton filem MKKP. Selain daripada itu, sumber sekunder menjadi sokongan kepada pandangan peribadi pemakalah dalam menilai filem MKKP.

Makalah ini menerapkan Teori Kepuasan Dan Kegunaan yang diperkenalkan oleh Katz, Gurevitch, dan Haas pada tahun 1973-1974. Teori ini amat berkait rapat dengan media dan mempunyai objektif dalam menerangkan kepuasan para audien. Teori ini memperkenalkan lima panduan keperluan sosial dan psikologi yang perlu dipenuhi oleh pengguna media. Lima panduan keperluan sosial dan psikologi yang perlu dipenuhi oleh pengguna media ini akan diperincikan seperti di bawah:

Keperluan Kognitif

Keperluan kognitif atau keperluan untuk memperoleh maklumat dan pengetahuan bagi meningkatkan pemahaman. Keperluan kognitif akan diteliti dalam keseluruhan kandungan filem MKKP. Persoalan seperti siapa Mat Kilau dalam filem MKKP? Siapakah tokoh-tokoh lain yang terlibat dalam filem tersebut? Dan bagaimana naratif filem MKKP menceritakan kembali tokoh-tokoh ini dalam bentuk kandungan filem untuk difahami oleh penonton yang memilih untuk menonton filem ini?

Keperluan Afektif

Keperluan afektif atau keperluan untuk mempunyai pengalaman estetik atau emosi. Bagi keperluan efektif, persoalan seperti adakah naratif filem MKKP berjaya dalam memberi sentuhan emosi dan juga pengalaman estetika kepada penonton? Persoalan ini diteliti berdasarkan pengalaman peribadi penonton semasa menonton filem MKKP. Selain itu, visual dan dialog dalam filem MKKP juga boleh mengusik emosi penonton. Oleh itu, keperluan afektif lebih tertumpu kepada emosi seorang penonton.

Keperluan Integratif

Keperluan integratif atau keperluan untuk mengukuhkan keyakinan, status atau kredibiliti. Keperluan ini mempunyai komponen kognitif dan afektif. Bagi meneliti keperluan integratif, ia diukur kepada bagaimana naratif filem MKKP mencerminkan tokoh sehingga mampu menimbulkan keyakinan, status dan kredibiliti watak-watak kepada penonton yang menonton filem MKKP?

Keperluan Integratif Sosial

Keperluan integratif sosial atau keperluan untuk mengukuhkan hubungan dengan rakan dan keluarga. Bagi keperluan ini, pertama ia diteliti dan dinilai kepada krew produksi yang bersama-sama dalam menjayakan penggambaran filem MKKP. Kedua, ia juga dinilai dan diteliti berdasarkan siapa penonton yang datang untuk menonton filem MKKP ini? Dua perkara ini menjadi aspek untuk meneliti dan membincangkan keperluan integratif sosial dalam filem MKKP.

Keperluan Mengurangkan Tekanan

Keperluan mengurangkan ketegangan atau keperluan untuk berehat. Keperluan ini merupakan suatu keperluan yang dicari oleh penonton semasa memilih karya filem yang ingin ditonton. Oleh itu, bagi meneliti keperluan mengurangkan tekanan, ia bersangkutan dengan keperluan integratif sosial. Persoalan yang ditanya dalam keperluan mengurangkan tekanan adalah adakah dengan menonton filem ini mengurangkan tekanan kepada penonton? Adakah filem MKKP memberi impak baik selepas selesai menonton filem MKKP? Penilaian keperluan mengurangkan tekanan juga lebih kepada penilaian peribadi pemakalah yang menonton filem MKKP ini.

PERBINCANGAN KANDUNGAN FILEM MKKP (2022)

Perbincangan kandungan filem MKKP dibahagikan kepada lima subtopik berdasarkan lima panduan keperluan sosial dan psikologi yang perlu dipenuhi oleh pengguna media. Sehubungan dengan itu, di bawah merupakan perbincangan lanjut kandungan filem MKKP bersandarkan kepada Teori Kepuasan Dan Kegunaan, lima panduan keperluan sosial dan psikologi yang perlu dipenuhi oleh pengguna media.

Filem MKKP berinspirasi watak dan kisah kepahlawanan Mat Kilau atau nama sebenarnya Mat Kilau bin Imam Rasu yang dibintangi oleh Dato Adi Putra. Filem ini merupakan filem fiksyen semata-mata. Babak filem MKKP dimulakan dengan suasana kampung di Kuala Tembeling dan kelihatan penduduknya sedang menjalankan masing-masing di bendang padi. Kemunculan orang-orang British telah mengganggu-gugat keamanan penduduk kampung dan British datang untuk menangkap tiga pemuda yang dikatakan sebagai pemberontak. Lalu berlaku pertikaman lidah dan menyebabkan British bertindak membunuh semua penduduk kampung yang berada di bendang padi tersebut. Peristiwa ini menjadi titik penolak naratif filem MKKP dan menyebabkan pembesar-pembesar Pahang sepakat untuk menentang British. Di sinilah Mat Kilau dan rakan-rakannya memainkan peranan sebagai pahlawan yang menentang kekejaman British. Filem diakhiri dengan kemenangan di pihak Melayu dengan pembunuhan pembesar British dalam naratif MKKP.

Gambar 2: Babak pertama di bendang padi merupakan pembukaan filem MKKP



(sumber: filem MKKP, 2022)

Keperluan Kognitif

Berdasarkan visual dan dialog yang diungkapkan dalam naratif filem MKKP, penonton diperkenalkan dengan beberapa tokoh pahlawan di Pahang. Antara tokoh-tokoh yang diperkenalkan dalam naratif filem tersebut adalah Dato Raja Haji Muhamad, Mufti Botok Haji Uthman, Tok Gajah, Dato' Bahaman dan Haji Sulong Semantan yang merupakan pembesar-pembesar negeri Pahang. Menurut penulis asal skrip filem MKKP, 60% daripada naratif

tersebut adalah diangkat daripada kisah benar (Abdul dalam Bernama, 2022). Walaupun filem MKKP adalah filem fiksyen, namun sebahagiannya adalah berdasarkan fakta sebenar.

Keperluan Afektif

Menerusi visual dan dialog MKKP, terdapat banyak visual dan dialog yang mengusik emosi penonton. Antaranya adalah, pada minit ke 00:03:40 sehingga minit ke 00:03:54, Salmah (dibintangi oleh Ellie Suriaty Omar) mengungkapkan satu dialog kepada British selepas pihak British iaitu pembunuh upahan British membunuh dengan menikam suaminya. Dialog tersebut berbunyi:

“Tidak ada istilah orang Melayu memberontak di bumi sendiri, kami mempertahankan hak. Kamu datang ke tanah kami untuk merompak hasil bumi kami.” (Salmah, MKKP, 2022).

Seterusnya, Salmah menambah lagi dengan mengungkap dialog:

“Demi Allah, demi Rasullullah, aku berpijak di bumi Pahang ini di bawah langit Allah yang aku junjung, kamu.., kamu.., kamu.., akan menyaksikan kebangkitan orang Melayu menentang kekejaman penjajah orang Putih.” (Salmah, 00:04:18 – 00:04:41, MKKP, 2022).

Disusuri dialog di atas, lalu pembesar British menembak mati Salmah. Perkara ini menyebabkan orang-orang kampung yang berada di tempat kejadian bangkit melawan. Terjadilah kejadian pembunuhan beramai-ramai yang dilakukan oleh pihak British. Semua yang berada di tempat kejadian, orang tua, wanita dan kanak-kanak tidak dilepaskan dan semuanya telah dibunuh oleh British.

Gambar 3: Penduduk kampung yang dikumpulkan di bendang sawah padi



(sumber: MKKP, 2022)

Gambar 4: Salmah ditembak selepas selesai mengungkapkan dialog pada minit 00:04:18 – 00:04:41



(sumber: MKKP, 2022)

Selain daripada itu, krew produksi yang terlibat berpeluang melihat sendiri suasana penuh emosi perjuangan Mat Kilau yang penuh tragis bersulam emosi walaupun hanya di set penggambaran. Antara babak lain yang tragis adalah kematian Rokiah isteri kepada Wahid rakan seperjuangan Mat Kilau yang sama-sama menentang British.

Gambar 5: Rokiah isteri Wahid yang sarat mengandung diseksa sebelum dibunuh



(sumber: MKKP, 2022)

Gambar 6: Wahid ditahan oleh Mat Kilau yang telah menyaksikan kematian isterinya Rokiah di tangan British



(sumber: MKKP, 2022)

Pengalaman estetik ini dapat menyuburkan semangat cintakan tanah air dan memetik tunas kemanusiaan serta penyatuan ummah. Penonton juga berpeluang menyelusuri pengalaman penuh emosi perjuangan tokoh negeri Pahang hinggakan ada yang memakai pakaian tradisional Melayu seperti Kebaya dan lelaki memakai pakaian silat dan tanjak sewaktu ke panggung wayang atas kapasiti kesatuan ummah serta mengapresiasi nilai estetik dan kemanusiaan.

Keperluan Integratif

Bagi keperluan integratif, naratif filem MKKP cuba menonjolkan dan mencerminkan kisah kepahlawanan dan kehebatan Mat Kilau dalam melawan penjajahan British. Dari sudut kepahlawanan, filem MKKP dipenuhi dengan adegan seni silat yang dipersembahkan oleh Mat Kilau dan rakan-rakannya. Sementara itu, penjajah British pula berlawan dengan menggunakan peralatan canggih pada zaman tersebut seperti senapang dan meriam untuk melawan kemaraan Mat Kilau dan rakan seperjuangannya. Cerminan kepahlawanan ini mampu menerapkan sifat yakin akan status dan kredibiliti Mat Kilau sebagai seorang pahlawan yang menentang kuasa British.

Pada peringkat ini juga, krew produksi cuba sedaya mungkin untuk berkongsi kemahiran masing-masing dan saling bantu-membantu tidak mengira kaum bagi mengukuhkan keyakinan bahawa filem Mat Kilau ini mampu mengubah landskap perfileman tanah air.

Keyakinan para penonton semakin bercambah apabila pihak Kerajaan dan NGO turut sama menyokong penayangan filem ini. Semestinya kredibiliti dan impak filem ini sukar dipertikaikan walaupun hakikatnya tidak semua penciptaan itu sempurna. Sesungguhnya perbezaan pendapat itu satu rahmat dan wajar diraikan.

Keperluan Integratif Sosial

Pembikinan filem MKKP melibatkan pelbagai etnik di Malaysia. Etnik Melayu, Cina dan India didapati bersama-sama dalam membangunkan produksi filem MKKP. Etnik Melayu diangkat sebagai perwira dalam filem MKKP manakala, etnik Cina dipilih sebagai pelakon sampingan yang bekerja di lombong emas, manakala etnik India, Punjabi sebagai tentera British.

Gambar 7: Etnik Cina sebagai pelakon sampingan yang bekerja di lombong emas



(sumber: MKKP, 2022)

Gambar 8: Etnik India, Punjabi, sebagai tentera British



(sumber: MKKP, 2022).

Penyatuan krew produksi amat penting dalam menjayakan sesebuah produksi filem. Dalam konteks filem MKKP, babak siang dan malam dilihat seimbang dan sama banyak. Justeru, krew produksi bersatu hati bersengkang mata demi mencapai matlamat untuk melahirkan buah tangan berunsur sejarah ini. Semestinya gratifikasi (ganjaran) akan diperolehi setara dengan usaha masing-masing.

Selain itu, penonton juga terdiri daripada keluarga, sahabat dan pelbagai etnik Malaysia. Mereka bersama-sama dalam sebuah panggung wayang menyaksikan filem MKKP ini. Hal ini telah disaksikan sendiri oleh pemakalah. Pemakalah sempat menyaksikan terdapat beberapa buah keluarga membawa seluruh keluarganya untuk menyaksikan filem MKKP ini. Terdapat juga penonton daripada pelbagai etnik Malaysia datang menyaksikan filem MKKP. Detik sebegini merupakan waktu terbaik untuk berkumpul sahabat taulan dan ahli keluarga bagi menonton kisah sejarah ini. Penyatuan ini wajar diteruskan pada masa akan datang agar wujud penyatuan ummah dan tema Keluarga Malaysia yang harmoni dan cintakan tanah air dapat direalisasikan.

Keperluan Mengurangkan Tekanan

Krew produksi dapat menarik nafas panjang dan tersenyum dengan sambutan filem MKKP ini. Gratifikasi daripada pihak penerbit pasti akan menyusul dan kesemua krew tidak kira bangsa dan agama akan mendapat habuan masing-masing dan dikesempatan ini mereka wajar berehat menghilangkan keluh lelah sewaktu penggambaran tempoh hari.

Sesungguhnya filem merupakan wadah cerminan masyarakat. Sekiranya kita ingin melihat milieu sesuatu masyarakat, maka tontonlah filem. Namun, usah terlalu rigid dalam mengatur mainan fakta berikutan produk filem bukanlah seperti kajian tesis Ph.D yang memerlukan rujukan, kesahan dan sebagainya. Cukup sekadar mengapresiasi jalan penceritaan sesebuah filem dan pada masa yang sama merehatkan cakerawala minda setelah penat seharian mengayuh hidup.

RUMUSAN DAN KESIMPULAN

Pemaparan kandungan ummah menerusi filem Malaysia merupakan suatu konsep yang perlu dirangkul oleh masyarakat Malaysia. Berdasarkan analisis filem MKKP, lima panduan keperluan sosial dan psikologi yang perlu dipenuhi oleh pengguna media telah disajikan kepada penonton dan krew produksi. Kesemua lima panduan keperluan ini iaitu keperluan kognitif, keperluan afektif, keperluan integratif, keperluan integratif sosial dan keperluan mengurangkan tekanan memenuhi keperluan penonton.

Berdasarkan penilaian peribadi pemakalah, dalam kelima-lima keperluan ini, keperluan kognitif, afektif dan integratif sosial diteliti melebihi keperluan integratif dan keperluan mengurangkan tekanan. Hal ini kerana, tiga keperluan tersebut diteliti lebih menyerlah dan memberi impak kepada penonton dengan disaksikan sendiri semasa melakukan penontonan di panggung wayang. Pemakalah dapat mendengar bisikan, esakan daripada para penonton dan panggung wayang yang dipenuhi dengan ahli keluarga masing-masing.

Pemakalah sendiri turut merasakan keperluan kognitif, afektif dan integratif sosial dalam memilih filem MKKP sebagai wadah hiburan dan ilmu. Filem yang berkisar semangat patriotik dilihat penting dalam menyemarakkan semangat penyatuan sebelum ianya hilang ditelan arus kemodenan (Deraman & Razak, 2018). Sehubungan dengan itu, garapan pengisian dalam filem MKKP yang sarat dengan nilai sejarah serta perjuangan pahlawan Melayu pada zaman penjajahan British di Pahang diteliti sebagai satu usaha yang jitu dalam menyatupadukan rakyat Malaysia yang berbilang bangsa.

RUJUKAN

- Adnan, M. H. (1988). Malaysian Films: Survival or Revival. *Media Asia*, Vol. 15, no 3. pp.155&156.
- Bernama. (2022, Jun 22). Filem Mat Kilau sarat dengan mesej patriotisme. *Astro Awani*. <https://www.astroawani.com/berita-hiburan/filem-mat-kilau-sarat-dengan-mesej-patriotisme-367608>.
- Bernama. (2022, Julai 25). Kutipan filem Mat Kilau cecah RM90 juta selepas 33 hari tayangan. *Sinar Harian*. <https://www.sinarharian.com.my/article/212939/berita/nasional/kutipan-filem-mat-kilau-cecrah-rm90-juta-selepas-33-hari-tayangan>.
- Deraman, N. A., & Razak, F. H. (2018). A Study of Unity and Patriotism Elements in Film *Ola Bola*: A Thematic Analysis. *Journal of Media and Information Warfare*.

- Elliott, P. (1974). Uses and gratifications research: A critique and a sociological alternative. In J. G. Blumler & E. Katz (Eds.), *The uses of mass communications: Current perspectives on gratifications research* (pp. 249–268). Beverly Hills, CA: Sage.
- Jumrah, M. H. (2019). Multiethnic Audiences Interpretation of National Identity in Malaysia Through ALternative Film of Nasi Lemak 2.0. *International Journal of Multicultural and Multireligious Understanding*. Vol. 6 Special Issue 2.
- Leha @ Zaleha Muhamat. (2004.) perpaduan Ummah Menurut Kacamata Islam. Kertas kerja dalam seminar Yayasan Dakwah Islamiah Malaysia (YADIM) dan Kolej Universiti Kejuruteraan Utara Malaysia (KUKUM), 27-29 Februari 2004, di Eagle Bay Resort Resort, Pulau Langkawi, Kedah <http://dspace.unimap.edu.my/xmlui/bitstream/handle/123456789/6428/Perpaduan%20Ummah%20Menurut%20Kacamata%20Islam.pdf?sequence=1&isAllowed=y>.
- Mat Kilau masuk senarai 'Top 10' dilebih 15 buah negara, tangga keempat di Israel. (2022, September 23). *Astro Awani*. <https://www.astroawani.com/berita-hiburan/mat-kilau-masuk-senarai-top-10-di-lebih-15-buah-negara-tangga-keempat-di-israel-382486>.
- Palmgreen, P. (1984). Uses and gratifications: A theoretical perspective. In R. Bostrom (Ed.), *Communication Yearbook 8* (pp. 20–55). Beverly Hills, CA: Sage.
- Razid, M. A. (2017). Patriotisme Nilai Jati Diri Dorong Rakyat Gigih Bangunkan Negara. Dlm. *Ariah Judah*. Mentari. Bil 2. Putrajaya: Bahagian Penerbitan Dasar Negara, Jabatan Penerangan Malaysia.
- Rosengren, K. E. (1974). Uses and gratifications: A paradigm outlined. In J. G. Blumler & E. Katz (Eds.), *The uses of mass communications: Current perspectives on gratifications research* (pp. 269–286). Beverly Hills, CA: Sage.
- Rubin, A. M. (1994b). Media uses and effects: A uses and gratifications perspective. In J. Bryant & D. Zillmann (Eds.), *Media effects: Advances in theory and research* (pp. 417–436). Hillsdale, NJ: Lawrence Erlbaum Associates, Inc.
- Shariff, S. Z., Sualman, I., & AdiIrawan, E. D. (2013). Fostering Unity Among Malaysians: A Case Study on the Local Film Industry. *International Journal of Humanities and Social Science*. Vol. 3 No. 10.
- Swanson, D. L. (1987). Gratification seeking, media exposure, and audience interpretations. *Journal of Broadcasting & Electronic Media*, 31, 237–254.
- Umi Atikah Mohd Kamil. (2017). *Kritikan Sosial Filem Talentime (2009)*. Kertas Penyelidikan Ijazah Sarjana Pengajian Melayu, Akademi Pengajian Melayu Universiti Malaya. Kuala Lumpur: Universiti Malaya.
- Zaidi Mohamad. (2022, Julai 25). Diangkat hero semula selepas fenomena Mat Kilau. *Berita Harian*. <https://www.bharian.com.my/hiburan/selebriti/2022/07/980187/diangkat-hero-semula-selepas-fenomena-mat-kilau>.

MALAYSIA
KELANTAN

Pengaruh Media Komunikasi Terhadap Perkembangan Bahasa Malaysia Pelajar Penutur Dialek Kelantan

Nuradlin Syafini
Universiti Malaysia Kelantan
adlinsyafini@yahoo.com

Zaleha Embong
Universiti Malaysia Kelantan
zaleha.e@umk.edu.my

Azman Bidin
Universiti Malaysia Kelantan
azman.bidin@umk.edu.my

ABSTRACT

Verbal communication techniques are where human communication began. Message sharing is expanding from verbal to electrical to digital communication as the Industrial Revolution 4.0 era develops. People may now engage more easily, even when they are separated by great distances, thanks to the revolution in communication media gadgets. However, the use of networks in communication media not only bridge the distance and facilitate communication. In reality, it has an impact on how school students learn the national language. As a result, the objective of this article is to examine how communication media have influenced the growth of national language of dialect speakers in Kelantan. In-depth interviews and a thematic analysis approach are used in this article's qualitative data analysis. Forteen form two students in total were chosen as respondents. The study's findings revealed that communication media networks can have a good impact on how well school students who regularly speak in the Kelantan dialect learn the national language. Enhancing dialect students' national language is one of positive consequence. This is an important reference for the government, educators, and parents in empowering the use of communication media content as a learning medium among teenagers.

Keywords: Media; Communication; National Language; Student; Dialect

ABSTRAK

Sejarah komunikasi manusia bermula dengan kaedah komunikasi secara lisan. Seiring dengan perkembangan zaman Revolusi Industri 4.0, perkongsian mesej berkembang daripada hanya secara lisan kepada media elektronik seterusnya komunikasi digital. Revolusi peranti media komunikasi telah memudahkan manusia berinteraksi walaupun dalam jarak jauh. Namun begitu, penggunaan rangkaian dalam media komunikasi bukan sahaja menghubungkan jarak dan melancarkan komunikasi. Malah, mempengaruhi perkembangan bahasa Malaysia dalam kalangan pelajar. Maka, objektif artikel ini adalah untuk meneliti pengaruh media komunikasi terhadap perkembangan bahasa Malaysia pelajar penutur dialek di Kelantan. Artikel ini menggunakan kaedah kualitatif iaitu temu bual secara mendalam dan kaedah tematik diguna untuk menganalisis data. Seramai 14 orang pelajar tingkatan 2 dipilih sebagai responden. Hasil dapatan mendapati rangkaian media komunikasi boleh mempengaruhi secara positif perkembangan bahasa Malaysia pelajar yang mengamalkan dialek Kelantan dalam pertuturan seharian. Pengaruh positif termasuklah menambah baik bahasa Malaysia pelajar berdialek. Hal ini menjadi rujukan penting kepada pihak kerajaan, para pendidik, dan ibu bapa dalam memperkasakan penggunaan kandungan media komunikasi sebagai medium pembelajaran dalam kalangan remaja.

Kata Kunci: *Media; Komunikasi; Bahasa Malaysia; Pelajar; Dialek*

PENGENALAN

Media komunikasi atau komunikasi massa adalah singkatan kepada perkataan istilah bahasa Inggeris, Mass Media Communication (Hadi et al, 2020). Komunikasi media massa terjadi apabila kaedah komunikasi yang berlaku mempunyai jarak dan menggunakan instrumental media seperti pembesar suara (*speaker*). Sebagai contoh, melalui telefon, siaran radio dan terbitan kandungan di televisyen. Media merupakan suatu perkataan berasal dari bahasa Latin iaitu medium yang membawa maksud penghubung, penyampai, atau pemberitahu (Riyana, 2012). Justeru, media komunikasi menjadi penghubung atau pengantara menyampaikan mesej (komunikator) kepada penerima apabila jarak menjadi suatu permasalahan dalam proses komunikasi tersebut.

Sejarah komunikasi manusia bermula dengan kaedah komunikasi secara lisan. Seiring dengan perkembangan zaman Revolusi Industri 4.0, perkongsian mesej berkembang daripada hanya secara lisan kepada media elektronik seterusnya komunikasi digital. Generasi remaja masa kini lahir di era media komunikasi tradisional seperti radio, akhbar, dan televisyen tidak lagi menjadi saluran utama untuk memenuhi keperluan hiburan dan informasi dalam masyarakat (Ahmad 'Afif Hamid & Norfarizah Mohd Bakhir, 2015). Kemajuan teknologi komunikasi telah membentuk rangkaian media komunikasi baharu iaitu media sosial. Media sosial telah mengubah cara manusia berinteraksi, bekerja, dan berkongsi informasi (Van Dijk, 2003; Ami Joselina Abu Bakar, 2018). Pelbagai pendapat telah dinyatakan tentang perkembangan media komunikasi terhadap remaja. Secara positif, media komunikasi telah menjadikan dunia seperti perkampungan global. Setiap individu dapat mengetahui tentang individu lain hanya dengan menekan satu klik butang (Yin, 2013).

Kekuatan media komunikasi dimanfaatkan oleh para pendidik dengan melibatkan pelajar mereka dalam perkampungan global untuk meningkatkan pengetahuan, kemahiran, dan keperluan membangunkan komuniti global bagi pelajar (Sawyer & Chen, 2012; Nichols, 2014; Dwyer, 2016; Meda, 2019, & Bastos, 2021). Walau bagaimanapun, konsep perkampungan global kurang diterima baik di negara Asia seperti Indonesia dan Malaysia berbanding di barat (Al Arifin, 2012). Hal ini kerana dikhuatiri dapat menghapuskan budaya asal sesebuah negara atau sesuatu tempat dengan normalisasi gaya hidup barat (Surahman, 2016).

Tidak dinafikan pengaruh media komunikasi memainkan peranan besar dalam pembentukan peribadi pelajar. Namun demikian, penggunaan media komunikasi merupakan satu keperluan kepada pelajar terutama dalam keadaan dunia dibatasi had pergerakan dan wabak (Engko & Usmany, 2020; Gumelar & Dinnur, 2020; Gusty et al., 2020). Rangkaian dalam media komunikasi telah memudahkan urusan pembelajaran, komunikasi, dan perkongsian maklumat. Maka, lebih wajar memikirkan langkah mengurangkan pengaruh buruk perkembangan teknologi daripada menafikan kepentingan media komunikasi dalam kehidupan harian para pelajar ini (Nadia Fauzi, 2017).

Selain itu, setiap rangkaian media komunikasi seperti televisyen, radio, akhbar, atau media sosial mempunyai kebaikan dan keburukannya. Manfaat yang diperolehi sepatutnya bergantung kepada cara pengguna mengurusnya. Hal ini kerana sesuatu kaedah seperti penggunaan komunikasi mungkin berfungsi lebih baik daripada kaedah yang lain dalam proses komunikasi bersama pelajar (Zaman, B., & Eliyawati, C., 2010). Revolusi peranti media komunikasi telah memudahkan manusia berinteraksi walaupun dalam jarak jauh. Namun

begitu, penggunaan rangkaian dalam media komunikasi secara berlebihan dan tidak terkawal boleh menimbulkan masalah sosial. Malah, mempengaruhi perkembangan bahasa Malaysia dalam kalangan pelajar. Maka, objektif artikel ini adalah untuk meneliti pengaruh media komunikasi terhadap perkembangan bahasa Malaysia pelajar penutur dialek di Kelantan.

SOROTAN LITERATUR

Terdapat banyak artikel berkenaan dengan pengaruh media komunikasi terhadap penyebaran dialek tetapi tidak banyak artikel yang dilakukan untuk meneliti pengaruh media komunikasi terhadap perkembangan bahasa Malaysia pelajar penutur dialek. Oleh itu, fokus utama artikel ini tertumpu kepada perkembangan bahasa Malaysia pelajar penutur dialek Kelantan menggunakan media komunikasi. Dialek merupakan kelainan dalam sesuatu bahasa yang menjadi ciri golongan tertentu dalam kalangan penutur sesuatu bahasa yang disebut sebagai bahasa daerah atau loghat (Abdul Jalil Anuar et al., 2016). Memetik kenyataan Ayatrohaedi dalam kajian Abdul Hamid Mahmood (1990), istilah dialek berasal daripada perkataan Yunani iaitu dialektos yang digunakan dalam hubungan dengan keadaan bahasa suatu tempat itu kerana wujudnya perbezaan-perbezaan kecil di dalam bahasa yang digunakan oleh setiap penduduk di sesuatu tempat itu. Nik Safiah Karim (1981) pula mendefinisikan dialek sebagai satu bentuk bahasa yang dikelaskan mengikut penggunaannya. Hal ini kerana setiap dialek mempunyai ciri-ciri tersendiri yang membezakannya dengan dialek-dialek yang lain.

Selain itu, Malaysia mempunyai 13 buah negeri yang menggunakan pelbagai dialek di daerah tersendiri. Menurut Norazila Alias (1986), sesuatu bahasa atau dialek itu boleh dipengaruhi daripada kelainan dalam unsur alam dan persekitaran di sesebuah tempat bahasa itu dituturkan. Sebagai contoh, masyarakat Kelantan mengutamakan dialek Kelantan dalam proses komunikasi (Maria Liza Latiff, 2002). Dengan erti kata lain, dialek Kelantan turut digunakan dalam proses pembelajaran antara guru dan pelajar di sekolah. Dialek Kelantan merupakan bahasa pertama masyarakat Kelantan tanpa mengira bangsa atau agama.

Pelajar yang berasal dari Kelantan terkenal dengan identiti ketimuran yang tinggi menggunakan dialek dalam komunikasi harian mereka termasuk di peringkat sekolah (Zuraidah Mohd Don, 2005). Para pelajar menggabungkan bahasa Malaysia dengan dialek tempatan dalam pertuturan harian mereka semasa proses pembelajaran di sekolah (Siti Rahimah Mustaffa et al., 2014). Hal ini menyebabkan kewujudan ragam bahasa Melayu dalam komunikasi harian mereka. Dialek Kelantan tergolong dalam bahasa tidak standard digunakan dalam komunikasi harian oleh masyarakat Kelantan yang hanya difahami oleh lingkungan masyarakat atau kawasan yang mempraktikannya sahaja (Siti Rahimah Mustaffa et al., 2017).

Menurut Siti Rahimah Mustaffa et al. (2017), pengaruh dialek dalam komunikasi boleh membawa kepada kemerosotan tahap keyakinan diri seseorang individu untuk berkomunikasi dengan berkesan. Kajian Ahmad (2006) menunjukkan terdapat hubungan yang signifikan antara kelemahan sebutan penutur yang dipengaruhi sebutan dialek tempatan yang disebabkan oleh proses peleburan terhadap setengah-setengah perkataan. Hal ini mengurangkan tahap keyakinan diri penutur untuk berdaya saing dengan pihak lain kerana lemah dalam komunikasi berkesan (Ahmad, 2006; Peng, 2016).

Menurut Krish et al. (2014), pelajar yang menggunakan dialek yang pekat dalam proses komunikasi yang bakal menempuhi banyak cabaran dan halangan berbanding pelajar yang menggunakan bahasa Malaysia dalam semua urusan. Antaranya, masalah dalam pembelajaran dan temu duga untuk mendapatkan pekerjaan setelah menamatkan zaman persekolahan. Oleh

hal yang demikian, pelajar ini memilih untuk bersosial dalam kalangan mereka sahaja dan bersosial secara berkelompok walaupun menetap di negeri lain (Krish et al., 2014).

Menurut Shahidi A. H. dan Rahim Aman (2010), kesedaran tentang pengaruh kuat dari penggunaan dialek perlu ditingkatkan kerana situasi ini bakal menyukarkan proses komunikasi semasa di alam pekerjaan kelak. Hal ini berlaku kerana para panel temu duga tidak dapat memahami perkataan-perkataan yang digunakan oleh calon-calon yang terpengaruh dengan penggunaan dialek. Jelas bahawa penguasaan kemahiran komunikasi berkesan sangat penting dalam mendapatkan pekerjaan (Berita Harian, 2016; Rahazimah Ibrahim & Abdul Razaq Ahmad, 2018).

Sayed Mahussain dan Fathiah (2010) pula menyatakan bahawa faktor pengaruh dialek turut berperanan menimbulkan gangguan terhadap perkembangan kemahiran komunikasi bahasa Malaysia pelajar dan merupakan satu faktor yang dominan dalam menentukan berlakunya perkara tersebut. Ang dan Che Radiah Mezah (2012) menegaskan pelajar Cina yang membesar dalam persekitaran menggunakan bahasa ibunda tidak mencapai keputusan yang baik dalam peperiksaan awam.

Malahan, mutu bahasa dalam komunikasi lisan dan tulisan pelajar dalam proses pembelajaran di dalam kelas turut terjejas (Siti Rahimah Mustaffa et al., 2017). Rusidah (2010) menjelaskan bahawa para pelajar sukar menguasai kemahiran komunikasi bahasa Malaysia dengan baik kerana subjek ini dianggap sekadar mata pelajaran yang wajib dipelajari sahaja dalam sistem pendidikan. Pengaplikasiannya di dalam urusan harian tidak dititikberatkan seperti bahasa-bahasa yang lain.

Pelajar yang membesar dalam persekitaran bertutur dalam dialek sering mengalami kesukaran dalam kemahiran komunikasi berkesan walaupun para pelajar itu memperoleh markah peperiksaan yang tinggi dalam mata pelajaran bahasa Malaysia di sekolah (Hassan Ahmad, 2000). Hal ini seiring dengan kenyataan Salinah Jaafar (2015) bahawa terdapat ramai pelajar terutama pelajar bukan Melayu yang mendapat keputusan yang cemerlang dalam subjek bahasa Malaysia namun gagal berkomunikasi dengan baik.

Oleh itu, cara penyampaian atau kemahiran berkomunikasi menggunakan bahasa Malaysia perlu diutamakan. Proses komunikasi tidak berjalan dengan baik sekiranya mesej yang dihantar tidak dapat difahami oleh pihak yang lain. Hal ini disebabkan oleh beberapa halangan seperti bahasa dan ejaan seterusnya mempengaruhi keyakinan pelajar dalam berkongsi pendapat (Lee, 2018).

Penguasaan kemahiran komunikasi dalam bahasa Malaysia perlu ditekankan di peringkat sekolah lagi terutama di sekolah-sekolah jenis kebangsaan agar para pelajar mampu berkomunikasi dan menulis dengan baik. Menurut Lee (2018), kelemahan berkomunikasi dalam bahasa Malaysia perlu diambil langkah yang tegas kerana mampu merosakkan bahasa kebangsaan malah menyebabkan generasi akan datang hilang kemahiran bertutur bahasa Malaysia dengan betul. Hal ini menunjukkan tanda-tanda kemerosotan sistem pendidikan negara (Berita Harian, 2015; Lee, 2018).

Di samping itu, Ma'sum Mohammad (2012) turut berpendapat bahawa masalah pelajar yang menggunakan dialek ialah lemah dalam kemahiran komunikasi berkesan. Sebagai contoh, aktiviti yang melibatkan pengucapan awam dan aktiviti yang melibatkan kemahiran komunikasi. Hal ini berlaku kerana mereka kurang mahir dalam kemahiran penukaran kod

bahasa dan menyingkirkan lengkok dialek secara langsung atau tidak langsung. Menurut Kreidler (1989), sebutan yang betul dan jelas adalah sangat penting supaya mesej yang disampaikan mudah difahami dan penutur juga perlu berkeyakinan tinggi ketika bercakap supaya mesej senang diterima oleh pihak lain. Tambahan pula, penutur mampu menghasilkan komunikasi yang berkesan jika mereka mempunyai sebutan dan intonasi yang baik walaupun tatabahasa mereka tidak tepat.

Kajian Huat (2003) menyatakan pengaruh dialek juga sering membelenggu guru kerana penguasaan asas bahasa Malaysia yang lemah dalam kalangan pelajar. Hal ini mempunyai hubungan dengan pengaruh dialek atau gangguan bahasa ibunda pelajar yang menjejaskan proses pembelajaran lisan. Menurut Peng (2016) pula pelajar juga terbawa-bawa pengaruh dialek mereka dalam aktiviti penulisan.

Kajian mengenai keunikan dan pemahaman tentang dialek di Malaysia bukanlah sesuatu kajian yang baru dalam kalangan para sarjana. Namun begitu, kajian yang meneliti pengaruh media komunikasi terhadap perkembangan bahasa Malaysia pelajar penutur dialek masih kurang diteliti oleh pengkaji lain. Oleh hal yang demikian, dalam kajian ini pengkaji ingin melihat pengaruh media komunikasi terhadap perkembangan bahasa Malaysia pelajar penutur dialek di Kelantan.

METODOLOGI KAJIAN

Kaedah Kajian

Artikel ini memfokuskan penelitian pengaruh media komunikasi terhadap perkembangan bahasa Malaysia pelajar penutur dialek di Kelantan. Data bagi artikel ini diambil daripada sebuah kajian kes berbentuk kualitatif. Kaedah kajian ini digunakan untuk mendapatkan data yang terperinci mengenai pengalaman yang dilalui oleh para responden yang bertutur dalam dialek dalam kehidupan seharian. Kaedah kualitatif lebih sesuai dipraktikkan jika melibatkan permasalahan melibatkan emosi, motivasi dan empati yang mengenai individu atau kumpulan tertentu, keadaan sosial atau peristiwa tertentu (Chua, 2006; Wimmer dan Dominick, 2014). Malahan, beberapa aspek tidak dapat dijelaskan berdasarkan angka-angka dalam data kuantitatif sahaja. Oleh itu, temu bual separa berstruktur bersama setiap responden telah dijalankan. Temu bual separa berstruktur memerlukan responden menjawab soalan terbuka yang diajukan. Bagi mendapatkan maklumat yang lengkap, kaedah temu bual mendalam digunakan untuk mengumpul data. Temu bual separa berstruktur merupakan temu bual mendalam yang sering digunakan dalam kaedah kualitatif (Jamshed, 2014). Sebanyak 10 soalan asas telah dibina bagi menjawab persoalan kajian. Temu bual dilaksanakan secara berasingan bagi setiap responden bagi memastikan isu kerahsiaan terjamin.

Sampel Kajian

Seramai 14 orang responden telah dilibatkan dengan bantuan guru dan menandatangani borang persetujuan yang dikemukakan. Profil demografi adalah seperti berikut:

Jadual 1. Profil Demografi Responden

Responden (Kod)	Umur Responden	Jantina Responden	Bahasa Pertuturan
P1	14	L	Dialek Kelantan
P2	14	L	Dialek Kelantan

P3	14	L	Dialek Kelantan
P4	14	L	Dialek Kelantan
P5	14	L	Dialek Kelantan
P6	14	L	Dialek Kelantan
P7	14	L	Dialek Kelantan
P8	14	P	Dialek Kelantan
P9	14	P	Dialek Kelantan
P10	14	P	Dialek Kelantan
P11	14	P	Dialek Kelantan
P12	14	P	Dialek Kelantan
P13	14	P	Dialek Kelantan
P14	14	P	Dialek Kelantan

Bagi proses pensampelan, teknik persampelan bertujuan telah digunakan. Responden merupakan pelajar tingkatan dua di tiga buah sekolah menengah kebangsaan di Kota Bharu, Kelantan. Kriteria pemilihan responden terbahagi kepada dua iaitu (i) responden merupakan penutur dialek (ii) kedua-dua ibu bapa pelajar berasal dari Kelantan.

Lokasi temu bual pula telah dipilih mengikut ketetapan guru bertugas serta melindungi privasi setiap responden dan tempat temu bual ditetapkan dalam sekitar kawasan sekolah responden sahaja. Pelajar sekolah tingkatan dua dipilih kerana mematuhi protokol pemilihan responden kajian lapangan yang ditetapkan oleh Kementerian Pendidikan Malaysia bahawa responden harus dari kelas bukan kelas peperiksaan. Senarai sekolah yang terlibat:

Jadual 2. Senarai Sekolah.

Nama Sekolah (Kod)
SMK1
SMK2
SMK3

Bahan Kajian

Dalam proses pengumpulan data ini, alat perakam suara (*recorder*) telah digunakan bagi merakam perbualan antara penemu bual dan pelajar. Proses rakaman temu bual ini menggunakan alat perakam suara sahaja tanpa alat rakaman video. Hal ini kerana penggunaan alat rakaman video didapati tidak sesuai untuk pelajar sekolah yang terdiri daripada individu berumur bawah 18 tahun. Sekiranya, sampel memberikan kebenaran sekalipun, hasil temu bual tidak begitu berkesan dan tidak berjalan lancar kerana sampel bakal lebih terganggu serta malu untuk memberi maklum balas kepada soalan-soalan yang diajukan. Hal ini akan menggugat keaslian rakaman temu bual sekaligus memberi nilai rendah terhadap dapatan kajian dan menggugat proses analisis dapatan kajian untuk menjawab objektif yang dibina. Proses temu bual responden secara lisan telah dijalankan selama 5 minit sehingga 15 minit. Tempoh masa temu bual yang relevan adalah tidak terlalu pendek dan tidak terlalu lama. Hal ini dinyatakan oleh Cook (1989) melalui Cutting (2005) bahawa ciri-ciri percakapan lisan yang boleh dikelaskan sebagai temu bual memerlukan bilangan individu perbualan yang sedikit, tempoh masa perbualan yang singkat, dan difokuskan kepada individu yang bakal menjawab soalan sahaja bukan orang sekeliling.

Analisis Kajian

Selepas proses temu bual mendalam, hasil temu bual diterjemahkan ke dalam bentuk transkrip, pengkaji telah menjalankan proses analisis tematik bagi mendapatkan tema-tema yang muncul daripada data mentah tersebut. Kaedah analisis ini dijalankan seperti berikut:

Rajah 1. Kaedah analisis.

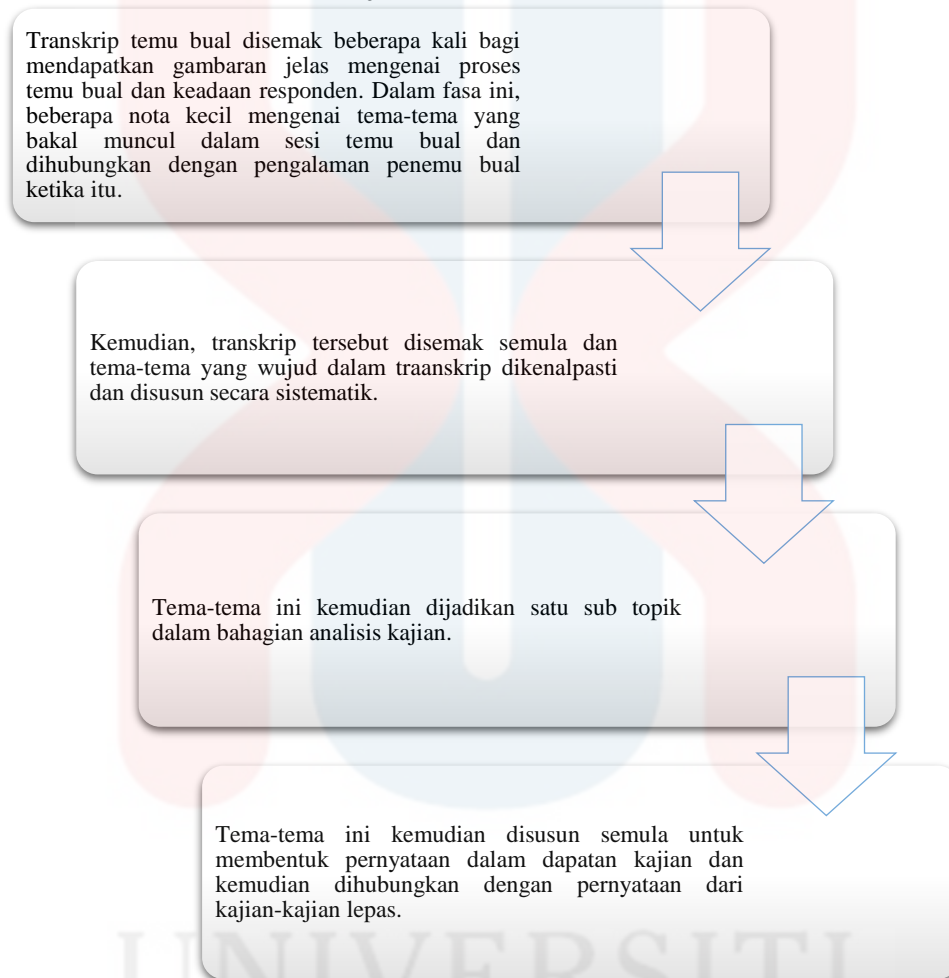

DAPATAN DAN PERBINCANGAN

Temu bual yang telah dijalankan terhadap responden telah menemukan pelbagai pengalaman dan perspektif. Tema media komunikasi telah dikenalpasti hasil daripada kekerapan pengulangan perkataan menonton drama dan kartun (animasi) di televisyen atau alat peranti. Tema-tema ini menggambarkan pengaruh media komunikasi kepada penguasaan bahasa Malaysia pelajar sekolah penutur dialek. Tema media komunikasi yang dikenalpasti akan menghuraikan lagi kesan-kesannya:

Media Komunikasi

Keadaan pelajar sekolah penutur dialek berbeza dengan pelajar sekolah yang lain terutamanya bagi pelajar sekolah penutur dialek di Kelantan khususnya keluarga yang aslinya berasal dari Kelantan. Hal ini kerana pelajar sekolah menengah kebangsaan di Kota Bharu, Kelantan menggunakan dialek Kelantan sepenuhnya dalam komunikasi di sekolah walaupun sesetengah

ibu bapa kepada pelajar berasal dari negeri lain. Para pelajar ini mengamalkan penggunaan dialek Kelantan dalam komunikasi bersama keluarga sehingga proses sosialisasi bersama rakan-rakan. Hal ini menjadikan dialek Kelantan menjadi bahasa pertama manakala bahasa Malaysia menjadi bahasa kedua dan diikuti bahasa Inggeris sebagai bahasa ketiga (Huat, 2003; Mohammad Fadzeli Jaafar et al., 2015).

Hasil penelitian menunjukkan para responden juga menjalankan penukaran kod bahasa semasa proses temu bual dijalankan. Para responden beberapa kali menjawab soalan-soalan temu bual menggunakan bahasa Malaysia bagi menyesuaikan keadaan semasa dan bahasa yang digunakan oleh penemu bual. Selain itu, responden-responden ini juga dapat menyesuaikan bahasa dengan lancar walaupun dibesarkan menggunakan dialek tempatan iaitu dialek Kelantan dalam komunikasi harian.

Berdasarkan temu bual yang dijalankan bersama responden-responden perempuan, para responden ini menyatakan bahawa penguasaan bahasa Malaysia mereka dikembangkan melalui tontonan drama Melayu di televisyen dan alat peranti. Penyiaran drama Melayu banyak membantu mereka menguasai kosa kata bahasa Malaysia. Drama Melayu yang ditonton juga mendedahkan mereka kepada unsur bunyi sebutan yang betul bagi sesetengah perkataan bahasa Malaysia. Hal ini disokong oleh Ainun Rahmah Iberahim et al. (2017) bahawa kemudahan-kemudahan teknologi yang digunakan sekarang memudahkan dan meningkatkan minat pelajar untuk mempelajari bahasa Malaysia dengan lebih mendalam.

Jadual 2: Contoh pernyataan pelajar perempuan tentang drama Melayu

Pernyataan pelajar

“...Boleh je cakap luar. Dah biasa duduk dengar cikgu mengajar guna bahasa standard. Lagi pon, kat tv banyak drama Melayu saya duduk tengok...”
(P8, SMK1)

“...Saya takde masalah nak cakap luar sebab suka tengok drama kat tv. Tak rasa kekok pon kalau sepupu bukan dari Kelantan balik sebab dah biasa dengar orang luar cakap kat tv...”
(P9, SMK 2)

Di samping itu, beberapa responden perempuan dan lelaki yang lain turut menyebut tontonan drama dan animasi dari negara lain juga antara faktor membantu mereka lancar berkomunikasi menggunakan bahasa Malaysia. Hal ini kerana tontonan drama atau animasi asing mampu mengembangkan kosa kata bahasa Malaysia mereka dengan membaca sari kata yang disediakan dalam bahasa Malaysia.

Jadual 3: Contoh pernyataan pelajar tentang drama dan animasi dari negara lain.

Pernyataan pelajar

“...saya kurang sikit tengok drama Melayu sebab saya lagi minat drama Korea. Tengok drama Korea pon banyak boleh belajar jugak sebab ada *substitle* bahasa Melayu. Saya guna *substitle* bahasa Melayu. Best sikit senang faham...”
(P10, SMK3)

“...sebab tengok drama Korea. Kan ada sari kata bahasa Melayu. Jadi kita tahu lah. Berlatih situ...”
(P11, SMK1)

“...saya suka tengok kartun Jepun. *Pehe* (Faham). *Kei ado substitle* bahasa Melayu (Kan ada *substitle* bahasa Melayu). *Belajar kecek luar situ* (Belajar bercakap bahasa Melayu di situ)...”

(P1, SMK2)

Berbeza pula dengan beberapa responden lelaki yang lain, mereka mengembangkan penguasaan bahasa Malaysia mereka melalui menonton animasi yang menggunakan suara latar bahasa Malaysia.

Jadual 4: Contoh pernyataan responden tentang animasi bersuara latar bahasa Malaysia
Pernyataan pelajar

“...Kalau dulu kan ada kartun macam Spongebob, Dora. Kartun tu kan guna bahasa Melayu. Sebab tu lah. *Berehi dulu tengok* (Suka tengok)...”
(P2, SMK3)

“...Belajar guna kartun. Tengok kartun macam Upin Ipin. Dulu ada banyak kartun kat TV9. Loni tengok di You Tube banyak (Sekarang banyak tengok di You Tube)...”
(P3, SMK1)

“...biasa *jah* (biasa je). *Tadok* masalah sebab *beso* tengok cerita kat tv (Tiada masalah sebab biasa tengok cerita di televisyen). *Kecek luar bulih* (Boleh bercakap bahasa Melayu baku). Tak takut...”
(P6, SMK3)

Ternyata, responden menguasai bahasa Malaysia mereka menggunakan media komunikasi selain penggunaan bahasa Malaysia oleh guru semasa sesi pembelajaran di sekolah. Hal ini sejajar dengan pernyataan Hazlin Falina Rosli et al. (2016) bahawa media komunikasi merupakan suatu medium yang dapat mendidik masyarakat tentang sesuatu isu dan membantu mereka untuk menghadapi sesuatu isu tersebut. Peningkatan dalam penguasaan bahasa Malaysia responden adalah hasil daripada tontonan drama dan animasi tempatan atau asing yang disiarkan di televisyen atau alat peranti. Rangkaian dalam media komunikasi bukan sahaja menjadi alat hiburan dan alat penghubung komunikasi bahkan mampu berfungsi sebagai medium pembelajaran kepada pelajar sekolah penutur dialek terutama di Kelantan. Hal ini seiring dengan prinsip komunikasi yang dikemukakan oleh Schramm (1971) bahawa komunikasi itu berfungsi sebagai proses memberitahu, mendidik, memujuk, dan menghibur. Selain itu, dapat dilihat juga bahawa latar belakang ibu bapa tidak mempengaruhi perkembangan bahasa Malaysia pelajar. Kesimpulannya, dapatan menunjukkan bahawa rangkaian dalam media komunikasi boleh mempengaruhi secara positif perkembangan bahasa Malaysia pelajar yang mengamalkan dialek Kelantan dalam pertuturan seharian. Pengaruh positif termasuklah menambah baik bahasa Malaysia pelajar penutur dialek.

RUMUSAN

Kepelbagaian dialek yang terdapat di Malaysia telah membuka ruang kepada para sarjana bidang komunikasi untuk mengkaji dan meneliti secara mendalam lagi kepentingan teknologi seperti media komunikasi kepada masyarakat. Perbincangan di dapatan kajian menunjukkan peranan yang dimainkan oleh media komunikasi dalam menyebarkan ilmu pengetahuan mengenai bahasa Malaysia. Hal ini secara tidak langsung membantu mengasah kemahiran komunikasi berbahasa Malaysia pelajar di luar bilik darjah. Tidak dinafikan penyalahgunaan media sosial banyak berlaku dalam kalangan remaja di bangku sekolah. Namun demikian, media komunikasi juga telah menjadi satu keperluan kepada pelajar terutama dalam dunia dibatasi had pergerakan dan wabak (Engko & Usmany, 2020).

Para remaja masa kini dikatakan seolah-olah mempunyai genetik internet sejak dilahirkan (Jamiah Manap et. al, 2016). Hal ini kerana remaja ini lahir dalam era aplikasi internet telah mula digunakan secara meluas di seluruh dunia. Media komunikasi telah banyak mempengaruhi masyarakat hari ini sehingga sukar dipercayai jika seseorang individu itu tidak menggunakan mana-mana alat peranti. Kini, hampir semua orang memiliki alat peranti canggih dari orang muda, tua, kaya, miskin dan lain-lain.

Oleh itu, lebih wajar memikirkan langkah pencegahan dan rawatan dalam isu penyalahgunaan media komunikasi dalam kalangan remaja berbanding menafikan kepentingan pendekatan media komunikasi dalam kehidupan seharian para pelajar (Nadia Fauzi, 2017). Kelebihan kaedah pembelajaran tradisional berbanding kaedah pembelajaran moden sepatutnya tidak diutamakan sekarang. Namun, perlu difikirkan bagaimana kedua-dua kaedah mampu membantu dalam mencapai matlamat meningkatkan penguasaan bahasa Malaysia para pelajar terutama pelajar penutur dialek. Hal ini kerana baik atau buruk penggunaan media komunikasi itu seharusnya bergantung kepada cara penggunaan seseorang individu. Seiring dengan pernyataan Tuch et al., (2016) dan Shamsul Amri Baharuddin (2022) bahawa setiap pengalaman baik atau buruk seseorang individu itu menggunakan teknologi bergantung kepada carian dan keperluan semasa menggunakannya.

RUJUKAN

- Abdul Hamid Mahmood. (1990). *Dialek Terengganu: Satu Tinjauan Ringkas*. Jurnal Dewan Bahasa. Kuala Lumpur: Dewan Bahasa dan Pustaka.
- Abdul Jalil Anuar, Abd. Hamid Mahmood, Tengku Fauziah Ku Mat, Abdullah Salleh & Ismail Salleh. (2016). *Glosari Dialek Kelantan*. Kuala Lumpur: Dewan Bahasa dan Pustaka.
- Ahmad. (2006). *Sebutan Bahasa Melayu Baku Dalam Kalangan Penutur Satu Kajian Kes*. (Doctoral dissertation, Fakulti Bahasa, Universiti Pendidikan Sultan Idris).
- Ahmad 'Afif Hamid & Norfarizah Mohd Bakhir. (2015). *Penerokaan Teknologi Melalui Seni dan Warisan Dalam Kearifan Tempatan (Penerbit USM)*. Penerbit USM.
- Ainun Rahmah Iberahim, Zamri Mahamod, & Wan Muna Ruzanna Wan Mohammad. (2017). Pembelajaran abad ke-21 dan pengaruhnya terhadap sikap, motivasi dan pencapaian bahasa melayu pelajar sekolah menengah (21th century learning and the influence of attitude, motivation and achievements Malay language secondary school student). *Jurnal Pendidikan Bahasa Melayu*, 7(2), 77-88.
- Al Arifin, A. H. (2012). Implementasi Pendidikan Multikulutral dalam Praksis Pendidikan di Indonesia. *Jurnal Pembangunan Pendidikan: Fondasi dan Aplikasi*, 1(1).
- Ami Joselina Abu Bakar. (2018). *Faktor Yang Mempengaruhi Sikap Pengguna Terhadap Pemasaran Media Sosial*. Universiti Utara Malaysia.
- Ang, L. H. & Che Radiah Mezah. (2012). *Masalah Penggunaan Bahasa Melayu dalam Kalangan Pelajar Etnik Cina di Malaysia*. *SOSIOHUMANIKA*, 5(2).
- Bastos, M. T. (2021). *From Global Village to Identity Tribes: Context Collapse and the Darkest Timeline*. Media and Communication.
- Berita Harian. (2015). *Bahasa Melayu Bahasa Rasmi ASEAN Hanya Mimpi?* Berita Harian Online. Retrieved October 13, 2018, from <https://www.bharian.com.my/node/97263>
- Berita Harian. (2016). *Kemahiran Komunikasi Tuntutan Utama Semua Jenis Pekerjaan*. Berita Harian Online. Retrieved November 9, 2018, from <https://www.bharian.com.my/node/211876>
- Cutting, J. (2005). *Pragmatics and discourse: A resource book for students*. Routledge.

- Chua, Y. P. (2006). *Kaedah dan Statistik Penyelidikan: Kaedah Penyelidikan Buku 1*. Selangor: McGraw-Hill Sdn Bhd.
- Dwyer, B. (2016). Teaching and learning in the global village: Connect, create, collaborate, and communicate. *The Reading Teacher*, 70(1), 131-136.
- Engko, C., & Usmany, P. (2020). Dampak Pandemi Covid-19 Terhadap Proses Pembelajaran Online. *Jurnal Akuntansi*, 6(1), 23-38.
- Gumelar, D. R., & Dinnur, S. S. (2020). Digitalisasi Pendidikan Hukum dan Prospeknya Pasca Pandemi Covid-19. *Al-Ahwal Al-Syakhsyiyah: Jurnal Hukum Keluarga dan Peradilan Islam*, 1(2), 111-122.
- Gusty, S., Nurmiati, N., Muliana, M., Sulaiman, O.K., Ginantra, N.L.W.S.R., Manuhutu, M.A., Sudarso, A., Leuwol, N.V., Apriza, A., Sahabuddin, A.A. & Hastuti, P. (2020). *Belajar Mandiri: Pembelajaran Daring di Tengah Pandemi Covid-19*. Yayasan Kita Menulis.
- Hadi, I. P., Wahjudianata, M., Sos, S., Indrayani, I. I., & SIP, M. S. (2020). *Komunikasi Massa*. Penerbit Qiara Media: Surabaya.
- Hassan Ahmad. (2000). *Ragam Bahasa Melayu*. Utusan Melayu (Malaysia).
- Hazlin Falina Rosli, Wan Amizah Wan Mahmud & Maizatul Haizan Mahbob. (2016). Peranan media sebagai alat kesedaran sosial dalam kalangan orang kurang upaya di Malaysia. *Jurnal Komunikasi: Malaysian Journal of Communication*, 32(2).
- Huat, T. M. (2003). Satu tinjauan terhadap sikap dan masalah guru Bahasa Melayu di sekolah rendah jenis kebangsaan. *Jurnal Penyelidikan MPBL*, 4, 16-25.
- Jamshed, S. (2014). Qualitative research method-interviewing and observation. *Journal of basic and clinical pharmacy*, 5(4), 87.
- Kreidler, C. W. (1989). *Pronunciation of English*. Basil Blackwell, Oxford, UK.
- Krish, P., Kamisah Osman, Subahan T. & Zanaton Iksan. (2014). *Persepsi Pelajar Prasiswazah Program Pengajian Bahasa Inggeris Mengenai Kecekapan Kendiri Dalam Kemahiran Kebolehgajian Dalam Sektor Pekerjaan*. Kajian Malaysia: Journal of Malaysian Studies, 32(2).
- Lee, L. T. (2018). *Antara Bahasa Kebangsaan Dan Bahasa Rojak*. Utama, Utusan Melayu Online. Retrieved May 10, 2020, from <https://www.utusan.com.my/rencana/utama/antara-bahasakebangsaan-dan-bahasa-rojak1.734178>
- Ma'sum Mohammad. (2012). *Strategi Komunikasi Dalam Kalangan Pelajar Bahasa Arab Di Jakarta* (Doctoral dissertation, University of Malaya).
- Maria Liza Latiff. (2002). *A Study On The Phonological Features Of Kelantanese Students'pronunciation Of English Consonants*. Academia Journal.
- Meda, L. (2019). Higher education curriculum in a global village. In *Globalization*. IntechOpen.
- Mohammad Fadzeli Jaafar, Norsimah Mat Awal, Mohammed Azlan Mis & Hayati Lateh. (2015). *Bahasa Sempadan Malaysia-Thailand: Pengekalan Vs Peralihan Bahasa*. Jurnal Pendidikan Bahasa Melayu, 5(1), 1-9.
- Nadia Fauzi. (2017). Penggunaan media sosial dalam dunia tanpa sempadan: Suatu kebaikan atau keburukan. *Institut Latihan Kehakiman dan Perundangan*.
- Nichols, C. N. (2014). *Facebook, Twitter, Blogs and the Global Village: A Content Analysis of Language and Formatting in Social Media*. The Pennsylvania State University the Graduate School School of Humanities.
- Nik Safiah Karim. (1981). *Beberapa Persoalan Sosiolinguistik Bahasa Melayu*. Dewan Bahasa dan Pustaka.
- Norazila Alias. (1986). *Dialek Kuala Pilah: Satu tinjauan fonologi dan leksikal* (Doctoral dissertation, Jabatan Pengajian Melayu, Universiti Malaya).

- Peng, C. F. (2016). *Masalah Pembelajaran Bahasa Melayu Dalam Kalangan Murid Cina Sekolah Rendah (Learning Problem of Malay Language among the Chinese Pupils Primary School)*. *Jurnal Pendidikan Bahasa Melayu*, 6(2), 10-22.
- Rahazimah Ibrahim & Abdul Razaq Ahmad. (2018). *Pengukuhan Kemahiran Insaniah Pelajar Tahun Akhir Di Ipts: Cabaran Menempuhi Alam Kerjaya*. Seminar Antarabangsa Isu-isu Pendidikan (ISPEN2018)|eISBN978-967-2122-54-8).
- Riyana, C. (2012). *Media pembelajaran*. KEMENAG RI.
- Rusidah. (2010). *Perbandingan Pengujaran Kata-kata Dua Subdialek Terengganu*. (Doctoral dissertation, Universiti Malaya).
- Salinah Jaafar. (2015). *Penggunaan Bahasa Ibunda Secara Inklusif Dalam Pendidikan Dengan Rujukan Kepada Bahasa Melayu*. In *Seminar Sambutan Hari Bahasa Ibunda Antarabangsa, Kelantan*.
- Sawyer, R., & Chen, G. M. (2012). The Impact of Social Media on Intercultural Adaptation. *Intercultural Communication Studies*, vol. 21, no. 2, 2012, pp. 151-169.
- Sayed Mahussain & Fathiah. (2010). *Kemahiran Berkomunikasi Secara Berkesan Dalam Kalangan Pelajar Sarjana Muda Sains Serta Pendidikan (Pengajian Islam)*.
- Schramm, W. (1971). *The Nature Of Communication Between Humans*. *The Process and Effects Of Mass Communication*, 3-53.
- Shahidi, A. H., & Rahim Aman (2010). Pengaruh dialek dalam pertuturan bahasa Melayu standard: Pencerakinan bunyi berasaskan spektrogram. *Jurnal Bahasa*, 10(2), 287-297.
- Siti Rahimah Mustaffa, Raja Masittah Raja Ariffin & Normahdiah Sheikh Said. (2014). *Kekeliruan Jati Diri Punca Bahasa Bercampur Aduk*. *Jurnal Bahasa*, 14(1), 134-158.
- Siti Rahimah Mustaffa, Raja Masittah Raja Ariffin, Adi Yasran Abdul Aziz & Mohd Sharifudin Yusop. (2017). *Pelestarian Dialek Kelantan di Besut dan Kaitannya Dengan Pembentukan Jati Diri*. *Jurnal Bahasa*, 17 (1). pp. 145-173. ISSN 1511-9084; ESSN: 2462-1889.
- Surahman, S. (2016). Determinisme teknologi komunikasi dan globalisasi media terhadap seni budaya Indonesia. *Rekam: Jurnal Fotografi, Televisi, Animasi*, 12(1), 31-42.
- Tuch, A. N., Schaik, P. V., & Hornbæk, K. (2016). Leisure and work, good and bad: The role of activity domain and valence in modeling user experience. *ACM Transactions on Computer-Human Interaction (TOCHI)*, 23(6), 1-32.
- Van Dijk, J. (2003). Divides in Succession: Possession, Skills, and Use of New Media for Societal Participation. In *Media Access* (pp. 253-274). Routledge.
- Wimmer, R.D. & Dominick, J.R. (2014). *Mass Media Research: An Introduction*. 10th Edition, Wadsworth, Cengage Learning.
- Yin, J. (2013). Global Village? What Global Village? *The 3rd World Journalism Education Congress Mechelen, Belgium*, July pg 3-5.
- Zaman, B., & Eliyawati, C. (2010). *Media Pembelajaran Anak Usia Dini*. Pendidikan Guru Pendidikan Anak Usia Dini (Pg-Paud) Jurusan Pedagogik Fakultas Ilmu Pendidikan Universitas Pendidikan Indonesia.
- Zuraidah Mohd Don. (2005). *Persepsi Pelajar Kelantan: Suatu Kajian Vitaliti Etnolinguistik*. *Jurnal Universiti Pendidikan Sultan Idris*. 1-17.

SENARAI TEMU BUAL

Temu bual bersama Prof. Ulung Datuk Dr. Shamsul Amri Baharuddin di Fakulti Pengajian Bahasa dan Pembangunan Insan, Universiti Malaysia Kelantan melalui rangkaian Google Meet pada 27 September 2021, jam 10.00 pagi.

PENGHARGAAN

Sebahagian sitasi dalam artikel ini adalah hasil daripada geran penyelidikan. Jutaan terima kasih ditujukan khas untuk Kementerian Pengajian Tinggi (KPT) yang telah menaja penyelidikan ini di bawah Fundamental Research Grant Scheme (FRGS), Grant no.: FRGS/1/2020/SS0/UMK/02/3, Fasa 1, bagi tahun 2020.



UNIVERSITI
MALAYSIA
KELANTAN

Pelaksanaan Tasmik di Sekolah Rendah Pasca PdPR dalam Kalangan Guru Pendidikan Islam Daerah Johor Bahru

Mohd Syafiq Azami bin Mohd. Helmi
Fakulti Pendidikan, Universiti Kebangsaan Malaysia
p111224@siswa.ukm.edu.my

Mohd. Isa bin Hamzah
Fakulti Pendidikan, Universiti Kebangsaan Malaysia
isa_hamzah@ukm.edu.my

ABSTRACT

This concept paper discusses the challenges in the implementation of tasmik after the home teaching and learning session (PdPR) is implemented. Tasmik is a method carried out to listen to the recitation of the Quran or memorization of students in front of the teacher face to face. Through this method, the teacher or counselor will be able to correct the student's reading mistakes directly. Face-to-face tasmik activities also allow the teacher to directly assess the reading, understanding, achievement and individual skills of the students, allowing the teacher to classify or record their performance. However, due to the recent COVID-19 pandemic, the tasmik method had to be adapted to online learning since the entire country was undergoing the Movement Control Order (MCO). As such, many students fall behind in tasmik achievement due to various constraints faced such as the absence of gadgets, limited internet access and the student's own commitment to study at home. The implication is that students face difficulties in starting over during face-to-face implementation of tasmik, causing tasmik objectives to be difficult to achieve. Even student achievement in tasmik also dropped sharply.

Keywords: *Tasmik, pasca PdPR challenges, face-to-face learning, pandemic COVID-19*

ABSTRAK

Kertas konsep ini membincangkan mengenai cabaran dalam pelaksanaan tasmik selepas sesi pengajaran dan pembelajaran di rumah (PdPR) dilaksanakan. Tasmik merupakan satu kaedah yang dijalankan untuk memperdengarkan bacaan al-Quran atau hafalan murid di hadapan guru secara bersemuka. Menerusi kaedah ini guru atau pembimbing akan dapat memperbetulkan kesalahan bacaan murid secara langsung. Aktiviti tasmik secara bersemuka juga membolehkan guru untuk menilai secara terus bacaan, kefahaman, pencapaian serta kemahiran individu murid seterusnya membolehkan guru mengklasifikasikan atau merekodkan prestasi mereka. Namun disebabkan pandemik COVID-19 yang lalu, kaedah tasmik terpaksa disesuaikan dengan pembelajaran dalam talian memandangkan seluruh negara ketika itu menjalani Perintah Kawalan Pergerakan (PKP). Oleh yang demikian, ramai murid ketinggalan dalam pencapaian tasmik berikutan pelbagai kekangan yang dihadapi seperti ketiadaan gajet, capaian internet yang terhad dan komitmen murid itu sendiri untuk belajar di rumah. Implikasinya murid berhadapan kesukaran untuk bermula semula semasa pelaksanaan tasmik secara bersemuka menyebabkan objektif tasmik sukar untuk dicapai. Malah pencapaian murid dalam tasmik juga menurun dengan mendadak.

Kata kunci: *Tasmik, cabaran pasca PdPR, pembelajaran bersemuka, pandemik COVID-19.*

PENGENALAN

Matlamat pendidikan di sesebuah negara akan dapat dicapai menerusi sistem yang berkesan serta wujudnya sekolah yang menepati aspek dan aspirasi pendidikan negara. Di Malaysia, sistem pendidikan negara telah mengalami pelbagai perubahan seiring dengan perkembangan

teknologi dalam era globalisasi ini. Dalam Rancangan Malaysia Ke-9 (RMK) turut dicatatkan perubahan dalam dasar pendidikan negara seperti Pelan Pembangunan Pendidikan Malaysia 2013-2025 (PPPM) yang bermatlamat melahirkan modal insan kelas pertama yang menepati aspek (JERI) iaitu seimbang dari segi jasmani, emosi, rohani dan inteletiknya sebagaimana yang terkandung dalam Falsafah Pendidikan Kebangsaan (Ainun Rahmah Iberahim, Zamri Mahamod & Wan Muna Ruzanna Wan Mohamad 2017).

Namun dalam keghairahan manusia dalam mengejar kemajuan, seluruh dunia dikejutkan dengan pandemik COVID-19 yang melanda bermula penghujung tahun 2019. Sesungguhnya wabak berkenaan telah membawa perubahan kepada hidup manusia khususnya di negara kita yang kini terpaksa mengharungi cabaran hidup dalam norma baharu. Bermula dengan Perintah Kawalan Pergerakan (PKP) yang pertama sehinggalah yang ketiga seperti yang telah dikuatkuasakan oleh kerajaan pada tahun lepas, seluruh aspek kehidupan seharian kita terjejas dan berubah sepenuhnya.

Sistem pendidikan juga tidak terkecuali daripada menerima kesannya. Rentetan daripada itu, Kementerian Pendidikan Malaysia (KPM) menetapkan supaya setiap sesi persekolahan dijalankan secara atas talian bagi menggantikan kelas secara bersemuka atau lebih dikenali sebagai pengajaran dan pembelajaran di rumah (PdPR). Hal ini menjadikan tugas dan tanggungjawab guru lebih mencabar kerana kecemerlangan serta keberhasilan seseorang murid bergantung kepada komitmen dan kualiti guru (Mohd Ridhuan, Shariza Said & Mohd Ibrahim 2014). Justeru, situasi berkenaan menyebabkan cabaran yang besar khususnya dalam pelaksanaan *tasmik* dan bacaan al-Quran secara dalam talian.

Namun ramai murid ketinggalan dalam pencapaian *tasmik* berikut pelbagai kekangan yang dihadapi seperti ketiadaan gajet, capaian internet yang terhad dan komitmen murid itu sendiri untuk belajar di rumah. Malah apa yang membimbangkan kini, kadar keciciran yang tinggi berpunca daripada PdPR mempengaruhi pencapaian kadar khatam al-Quran di peringkat sekolah rendah terutamanya murid tahun enam. Oleh yang demikian, langkah yang drastik dan produktif perlu difikirkan bagi mendepani cabaran berkenaan.

ISI-ISI UTAMA

Perkembangan Pengajaran Pembacaan al-Quran

Iqra' yang bererti bacalah, merupakan ayat atau wahyu pertama yang diturunkan kepada Nabi Muhammad s.a.w di Gua Hira' yang menggambarkan peri pentingnya menuntut ilmu dalam ajaran Islam. Malah, pengajaran pembelajaran al-Quran telah mula berkembang sejak dari peristiwa baginda menerima wahyu yang pertama tersebut. Menurut Kamarul Azmi dan Mohd Aderi (2013), secara umumnya terdapat dua kaedah pengajaran tilawah al-Quran di Malaysia iaitu kaedah *Baghdadiyyah* dan kaedah *Iqra'*.

Kaedah *Baghdadiyyah* merupakan teknik pengajaran yang dimulai dengan mengenal huruf-huruf hijaiyyah, diikuti dengan huruf bersambung dan berbaris. Apabila selesai mengenal kedua-dua bentuk huruf ini, barulah dipindahkan membaca al-Quran. Sebelum membaca al-Quran yang sebenar, murid didedahkan dengan membaca juzuk yang ke-30 bermula dari surah an-Nas hingga surah an-Naba'. Pengajaran dan pembelajaran al-Quran melalui kaedah ini melalui tiga fasa atau peringkat iaitu:

- i. Pembacaan secara umum iaitu murid diajar untuk membaca secara betul serta ditekankan hukum tajwid. Guru juga ditugaskan untuk membina asas dalam mengenal huruf dan baris.

- ii. Peringkat pengulangan bacaan iaitu dengan menekankan penguasaan hukum tajwid melalui kaedah sebutannya agar lebih baik dan mantap.
- iii. Pembacaan berirama dan berlagu. Setelah murid lancar sepenuhnya pembacaan serta hukum asas tajwid, mereka akan diajari cara melagukan ayat-ayat al-Quran dengan kaedah yang betul seperti tarannum *Bayyati, Nahawand, Hijaz dan Rast*.

Teknik atau kaedah ini sememangnya sudah tidak asing lagi dalam kalangan masyarakat Melayu tradisional. Penggunaan buku muqaddam yang lebih memfokuskan kepada pembinaan kemampuan dan kemahiran membaca al-Quran dengan betul adalah kaedah pengajaran yang sememangnya telah dilalui zaman-berzaman sebelum munculnya kaedah *Iqra'* sebagaimana yang diketahui mula dipraktikkan dalam sesi *tasmik* di sekolah-sekolah seluruh Malaysia.

Kaedah *Iqra'* merupakan satu kaedah yang diperkenalkan oleh Almarhum Ustaz As'ad Humam yang mengandungi enam jilid kesemuanya mencakupi setiap aspek sukatan pembelajaran al-Quran. Secara umumnya teknik ini adalah proses mengajar murid untuk membaca dengan cepat melalui kaedah membunyikan secara terus huruf-huruf hijaiyyah yang telah diletakkan baris tanpa perlu mengeja yang berbeza dengan kaedah *baghdadiyyah*. Buku *iqra'* dikarang dan disusun secara bertahap antaranya barisan huruf, perkataan atau ayat pendek sebagai pengenalan, dan sedikit latihan pengukuhan pembacaan di bahagian akhir setiap jilid berkenaan sebelum murid boleh meneruskan pembelajaran ke jilid yang seterusnya.

Secara umumnya kaedah *iqra'* ini mengandungi 12 prinsip teknik pengajarannya sebagaimana yang telah disusun oleh Ustaz As'ad Humam (2000) berdasarkan rajah di bawah iaitu:



Rajah 1: 12 Prinsip pengajaran *iqra'*

Pelaksanaan *Tasmik*

Tasmik berasal daripada perkataan Bahasa Arab iaitu “*sama’a*” yang bermaksud dengar atau kata kerja bagi perbuatan mendengar. Jadi secara umumnya *tasmik* ini adalah perbuatan mendengar manakala dalam aspek pendidikan, *tasmik* merujuk kepada perbuatan guru mendengar bacaan atau hafalan murid khususnya bacaan al-Quran. Kaedah *tasmik* ini pada asalnya merupakan salah satu daripada lima model yang terdapat dalam kurikulum j-QAF di mana program ini adalah antara usaha kementerian untuk memperkasakan pelaksanaan Pendidikan Islam di sekolah rendah (JAPIM 2004). Bahan bantu mengajar bagi waktu *tasmik* di sekolah kebiasaannya adalah al-Quran rasm Uthmani atau iqra’ mengikut tahap murid serta buku rekod bacaan murid. Selaras dengan kecanggihan teknologi pada hari ini, kebanyakan sekolah telah menggantikan buku rekod bacaan murid ini dengan mengisinya secara dalam talian melalui sistem yang disediakan oleh Bahagian Pendidikan Islam (BPI) pejabat pendidikan daerah masing-masing.

Abdul Hafiz & Nursafazilah (2016) menyatakan kaedah *tasmik* membolehkan guru membimbing murid agar dapat meneruskan hafazan dengan baik dan catatan perlu dilakukan untuk mengukur tahap pencapaian mereka. Selain itu, kaedah *tasmik* boleh dilakukan dengan cara guru meminta murid supaya menguatkan bacaan sesuatu ayat yang telah ditentukan oleh guru itu sendiri. Guru akan mendengar bacaannya dengan teliti di samping berperanan untuk memperbetulkan kesalahan daripada bacaan tersebut jika ada. Guru juga boleh menyoal hukum bacaan pada ayat yang dibaca oleh murid sama ada tajwid ataupun makna bacaan tersebut bertujuan untuk mengenal pasti kemahiran serta penguasaan murid dalam hukum tajwid (Anisa Ida 2014).

Dari aspek yang lain, kaedah *tasmik* sebenarnya sangat sesuai untuk diaplikasikan pada semua peringkat sama ada dari kanak-kanak hingga dewasa kerana melalui kaedah ini, penguasaan murid terhadap ayat yang dibaca dan diajar akan dapat dikesan dengan cepat oleh guru di samping mengetahui kelemahan bacaannya (Musliza & Mokmin 2014). Secara tidak langsung guru dapat mengesan tahap sebenar kebolehan murid dan memastikan mereka tidak mengulangi kesilapan tersebut serta mendisiplinkan murid dengan cara yang lebih efektif (Abdul Hafiz & Nursafazilah 2016).

PENYATAAN MASALAH / ISU KAJIAN

Sepanjang tempoh penguatkuasaan Perintah Kawalan Pergerakan (PKP), Kementerian Pendidikan Malaysia (KPM) telah memperkenalkan Pengajaran dan Pembelajaran di Rumah (PdPR) menggantikan PdPc secara bersemuka termasuk dengan menyediakan manual pelaksanaannya. Manual tersebut adalah sebagai panduan guru untuk melaksanakan sesi pengajaran mengikut sukatan semasa. PdPR juga boleh dikenali sebagai pembelajaran atas talian di mana guru dan murid berada di rumah masing-masing dan menggunakan pelbagai medium elektronik seperti telefon pintar, komputer riba, tab dan sebagainya. Kementerian Pendidikan Malaysia (2020) turut mencadangkan alternatif sekiranya murid tidak mempunyai capaian internet, mereka boleh memuat turun soalan terlebih dahulu untuk mengulang kaji dan menyiapkan tugas yang diberikan dengan menggunakan alat peranti masing-masing.

Dalam dunia moden yang kian mencabar kini, pendidikan merupakan tunjang kepada pembangunan sesebuah negara termasuklah ekonomi dan kemajuan teknologi (Muhammad Sham Shahkat Ali 2006). Pendidikan juga boleh mengubah daripada nilai-nilai kebudayaan kepada individu masyarakat melalui pelbagai kaedah dan cara (Hassan Langgulung 1987). Oleh yang demikian, pelbagai usaha dilakukan oleh para guru demi memastikan murid-murid tidak ketinggalan sukatan pembelajaran yang telah ditetapkan. Hal ini kerana sistem

pendidikan tidak boleh terhenti begitu sahaja walaupun terdapat kekangan untuk menjalankannya secara konvensional ataupun bersemuka. Norma baharu inilah yang perlu dihadapi oleh setiap golongan yang terlibat dalam dunia pendidikan. Tambahan pula, pelaksanaan PdPR yang lepas bagi murid sekolah rendah dan pelajar sekolah menengah di seluruh negara dilihat bukan sahaja memberi cabaran baru kepada ibu bapa, malah guru dan pelajar sendiri turut berdepan dengan pelbagai isu (Harian Metro 2021).

Namun begitu, terdapat pelbagai inisiatif untuk menjalankan pembelajaran digital atau secara dalam talian di sebalik halangan untuk mengadakannya secara bersemuka atau di bilik darjah. Walaupun Zetty (2020) menyatakan bahawa tidak semua ilmu dan pembelajaran yang disampaikan secara digital atau atas talian berkesan, tetapi setidaknya-tidaknya usaha untuk menyampaikan ilmu kepada murid-murid agar tidak ketinggalan itu tetap ada. Di pihak guru, perasaan gusar dan sangsi timbul terhadap kaedah yang sesuai untuk dilakukan semasa kelas atas talian di mana kebanyakan guru akhirnya akan menggunakan kaedah cuba jaya, iaitu dengan menggunakan mana-mana cara atau platform dan melihat kepada kesesuaiannya (Roslinda 2020). Manakala isu di pihak murid pula ialah kekangan gajet ataupun telefon pintar peribadi di mana terdapat murid yang berkongsi gajet dengan adik beradik atau ibu bapa. Malah terdapat juga yang menghadapi masalah capaian internet yang tidak memuaskan dan data internet yang tidak mencukupi seterusnya menyukarkan mereka untuk mengikuti sesi PdPR tersebut.

Namun begitu, proses pelaksanaan *tasmik* amat penting untuk dilakukan secara bersemuka (Norhidayati 2020). Hal ini kerana apabila dilakukan secara dalam talian sebelum ini, antara cabaran yang ketara adalah sebutan murid yang kurang jelas atau lebih cepat daripada yang tertera pada skrin menyebabkan kesukaran bagi guru untuk menegur secara terus kesilapan murid berkenaan. Selain itu, apabila melibatkan *tasmik* hafazan al-Quran pula kebiasaannya melibatkan murid membaca hafalan mereka tanpa melihat mushaf al-Quran seperti ayat-ayat hafazan dan surah-surah pilihan. Namun apabila dilakukan secara tidak bersemuka, penilaian guru tentang hafalan tersebut agak terbatas dan bergantung kepada kejujuran murid itu sendiri.

Selain itu, kekangan masa juga merupakan isu yang perlu dihadapi guru semasa menjalankan kaedah *tasmik*. Dengan peruntukan masa hanya dua waktu atau satu jam seminggu, sudah pasti menyebabkan bilangan murid yang terlibat terhad. Menurut Hajarul Bahti, Mohd Huzairi, Bani Hidayat dan Nor Hayati Fatmi (2010), kekangan masa yang dihadapi oleh guru adalah berpunca daripada peruntukan masa Pendidikan Islam yang agak sedikit terutama dalam bidang Tilawah al-Quran. Kesannya proses pemantapan bacaan murid akan sedikit terbantut dengan peruntukan masa yang singkat. Hal ini kerana banyak aspek yang perlu dititikberatkan dalam pengajaran *tasmik* al-Quran ini seperti hukum asas tajwid, makhraj huruf, teknik bacaan dan sebagainya.

Tahap penguasaan pembacaan murid yang berbeza juga merupakan salah satu cabaran yang dihadapi guru terutama semasa PdPR yang lalu. Pada ketika itu guru terpaksa mencari inisiatif untuk tidak mencampurkan murid yang telah menguasai dengan tidak menguasai bacaan al-Quran supaya tidak mengganggu proses pembelajaran. Hal ini berbeza dengan kelas secara bersemuka kerana murid yang sudah menguasai bacaan al-Quran ini kebiasaannya akan menjadi pembimbing atau digelar sebagai murid turus untuk membantu guru mendengar bacaan murid yang masih lemah. Jadi guru hendaklah mencari jalan penyelesaian agar mereka tidak keciciran kerana murid yang lemah dan tidak mempunyai asas yang kukuh dalam

pembacaan al-Quran adalah berpunca daripada kurangnya penekanan di peringkat sekolah rendah lagi (Hajarul Bahti et al. 2010).

Implikasi PdPR Terhadap Pelaksanaan *Tasmik*

Pelaksanaan pengajaran dan pembelajaran khususnya *tasmik* semasa PdPR bukanlah sesuatu yang mudah. Ehwan Ngadi (2020) menyatakan bahawa pendidikan dalam talian adalah implikasi yang ketiga dalam pentaksiran holistik kerana masih terdapat sisi positif walaupun ianya kelihatan mempunyai kesan negatif sebagaimana yang dinyatakan oleh sesetengah pengkaji.

Namun, mahu atau tidak pembelajaran dalam talian tetap menjadi pilihan utama dan dilihat sebagai satu-satunya solusi yang terbaik sepanjang tempoh PKP yang lepas. Oleh yang demikian, guru atau pendidik perlu menyediakan bahan-bahan pengajaran yang diperlukan sebelum melaksanakan pembelajaran dalam talian. Pada waktu itu guru juga harus berusaha meningkatkan kemahiran diri terutamanya dalam teknologi maklumat, pedagogi dalam talian serta cara membuat penilaian dalam talian. Meskipun diketahui kekangan capaian internet merupakan isu utama yang dihadapi oleh murid-murid khususnya selain faktor lokasi juga antara penyebab pembelajaran dalam talian ini sukar untuk dilaksanakan. Namun begitu, kaedah pemilihan platform yang bersesuaian seperti penggunaan aplikasi *Zoom*, *Google Meet*, *Google Classroom*, *Whatsapp* dan *Telegram* perlu dipilih dengan bijak supaya memudahkan setiap pihak di samping dilihat berkesan kerana aplikasi berkenaan bukan dalam bentuk “*real time*”.

Dalam tempoh PKP Ketika itu juga, para guru mengakui cabaran pelaksanaan PdPR sememangnya tinggi dan dalam masa yang sama keciciran dalam kalangan murid tidak dapat dielakkan. Meskipun diakui pelbagai aplikasi yang dapat digunakan untuk tujuan tersebut namun sudah pasti ianya tidak sama dengan pengajaran secara bersemuka. Begitu juga dalam pelaksanaan *tasmik* secara dalam talian. Kekurangan kaedah dalam talian ini menyebabkan murid kurang fokus akan pembedaan bacaan yang dilakukan oleh guru dan menyebabkan mereka mengulangi kesalahan berkenaan berulang kali.

Implikasi lain adalah kesukaran untuk mencapai objektif *tasmik* itu sendiri. Memandangkan kurangnya tumpuan murid terhadap pembedaan yang dilakukan oleh guru mengakibatkan mereka akan mengulangi kesalahan yang sama dan akan menyebabkan proses khatam bacaan al-Quran akan lambat serta bertambah tempohnya. Sebagaimana yang diketahui, objektif pelaksanaan *tasmik* adalah untuk memastikan murid untuk menguasai bacaan al-Quran secara bertajwid ketika waktu rasmi persekolahan sebelum menempuh sekolah menengah (Ahmad 2011). Oleh yang demikian, secara tidak langsung objektif berkenaan akan sedikit terjejas tanpa pemantauan dan tindakan yang sepatutnya diambil oleh kedua belah pihak.

Implikasi seterusnya adalah akan berlakunya keciciran murid dalam pelaksanaan *tasmik*. Sebagai contoh keadaan di mana murid-murid tidak dapat dihubungi oleh guru melalui aplikasi-aplikasi yang telah disediakan, lalu guru terpaksa meminta rekod bacaan atau hafalan murid secara rakaman video. Walaupun boleh dilaksanakan, guru akan sukar untuk menegur kesalahan yang dilakukan murid secara langsung. Tambahan pula sekiranya melibatkan bilangan murid yang ramai dan terdapat segelintir murid yang tidak memberikan kerjasama untuk menghantar rakaman video yang diminta.

Justeru, guru terpaksa merakam teguran tersebut untuk dihantar semula kepada setiap individu berkenaan di mana akan mengambil masa yang panjang dan menyebabkan kurang keberkesanannya. Walaupun begitu, ianya tetap perlu dilaksanakan bagi mengelakkan murid dari keciciran daripada mengikuti proses pembelajaran tersebut. Dalam masa yang sama ianya

turut merangsang sistem kognitif pembelajaran murid walaupun dalam keadaan tidak segerak untuk terus belajar secara berterusan (Nor Hidayati 2020).

CADANGAN PENAMBAHBAIKAN

Sebagaimana yang telah dibincangkan seperti di atas, proses pelaksanaan *tasmik* pasca PdPR ini perlu bergerak seiring dengan kemajuan teknologi maklumat masa kini. Beberapa perubahan yang berlaku haruslah diambil kira oleh para guru khususnya guru Pendidikan Islam bagi memastikan pengajaran mereka berkesan di samping menarik, inovatif dan menyeronokkan murid meskipun sedia maklum bahawa waktu pengajaran *tasmik* merupakan antara waktu yang digeruni murid yang kurang berkebolehan membaca al-Quran atau menghafal.

Selain itu, guru juga perlu mencari inisiatif untuk menghidupkan suasana pembelajaran yang menyeronokkan sudah pasti akan mampu menarik minat murid untuk mengikuti sesi pengajaran *tasmik* seterusnya memberikan kerjasama yang sepatutnya. Hal ini kerana untuk menjamin keberkesanan PdP al-Quran, guru harus merancang dan mengurus langkah-langkah pengajaran dengan teratur supaya tiada aspek penting yang tertinggal (Mohd Yusof 2005). Berikut merupakan beberapa cadangan penambahbaikan yang boleh diambil kira dalam melaksanakan pengajaran *tasmik* semasa PdPR ini :

- i. Penggunaan media maya mengikut panduan pelaksanaan Pengajaran dan Pembelajaran (PdP): Murid perlu diberi pendedahan kepada pelbagai jenis aplikasi dan teknologi terkini yang mempunyai pelbagai faedah pengajaran dan pembelajaran. Tambahan pula dengan adanya pelbagai teknologi dan aplikasi moden pada hari ini, guru boleh memaksimumkan penggunaan aplikasi tersebut dengan memasukkan beberapa aktiviti dan mini permainan yang menarik seperti *Kahoot*, *Quizzies* dan sebagainya. Hal ini akan membuatkan murid lebih tertarik untuk mengikuti sesi pengajaran yang disampaikan oleh guru.
- ii. Penggunaan video animasi semasa proses *tasmik*: Alternatif ini sememangnya memerlukan sedikit kerja keras daripada guru dalam memastikan objektif *tasmik* tercapai. Guru boleh membentuk kumpulan dan menetapkan jadual berdasarkan tahap kebolehan setiap murid dan mengadakan *tasmik* mengikut tahap murid dalam satu-satu masa agar apa yang diajari guru menyamai dengan tahap kumpulan yang disasarkan. Sebagai contoh murid yang membaca *iqra'* 1 hingga 3 dalam satu kumpulan manakala 4 hingga 6 dalam kumpulan yang lain dan begitu juga dengan yang telah membaca al-Quran. Penetapan masa bagi setiap aktiviti yang diadakan bergantung kepada tahap kefahaman dan kebolehan murid sendiri.
- iii. Menjalankan kaedah 4M : 4M terdiri daripada empat langkah yang dilaksanakan semasa pengajaran *tasmik* iaitu mendengar, membaca, melihat dan menulis dan boleh dikatakan kebanyakan subjek di sekolah turut menerapkan kaedah yang sama. Kaedah ini juga turut dipraktikkan semasa pengajaran *tasmik* secara bersemuka sejak sekian lama.
- iv. Penggunaan aplikasi-aplikasi sedia ada dan mudah diakses : Aplikasi yang mudah dan telah menjadi kebiasaan bagi generasi masa kini seperti *Whatsapp*, *Telegram* dan *Youtube* juga boleh digunakan guru untuk menjalankan sesi pengajaran. Oleh itu, guru boleh menggunakan ruang tersebut untuk bersemuka dengan murid dan menjalankan sesi pengajaran *tasmik* bersama mereka.
- v. Penambahan peruntukan masa untuk *tasmik* dalam seminggu : Hajarul Bahti et al. (2010) menyatakan kekangan masa yang dihadapi oleh guru adalah berpunca daripada peruntukan masa Pendidikan Islam yang agak sedikit terutama dalam bidang Tilawah

al-Quran. Oleh yang demikian, Panitia Pendidikan Islam boleh mengambil inisiatif bersama pentadbir sekolah untuk memperuntukkan waktu yang lebih bagi sesi *tasmik* sekurang-kurangnya tiga waktu seminggu. Pembahagian kumpulan mengikut tahap beserta tambahan guru untuk sesi *tasmik* dalam satu-satu kelas juga boleh dijadikan jalan penyelesaian bagi kesuntukan masa tersebut.

- vi. Latihan dalam pendidikan dan pembangunan profesionalisme yang berterusan: Sebagai seorang profesional, guru seharusnya meningkatkan kemahiran sendiri dalam bidang teknologi maklumat ini dengan menyertai kursus-kursus *online* dan webinar yang melibatkan kemahiran pelaksanaan pengajaran dan pembelajaran dalam bilik darjah yang dianjurkan oleh KPM. Hal ini juga dapat membantu guru menjana idea yang baru dan segar untuk mempelbagaikan kaedah pengajaran dalam bilik darjah.

KESIMPULAN

Sememangnya diakui kesabaran yang tinggi sangat diperlukan sama ada di pihak guru ataupun murid semasa pelaksanaan *tasmik*. Dalam pengajaran al-Quran, kaedah *tasmik* amat penting supaya dapat dinilai kelancaran hafazan al-Quran oleh murid di samping bertujuan memelihara kalam Allah sebagaimana sunnah Nabi Muhammad s.a.w yang menerima wahyu daripada Malaikat Jibril secara *talaqqi* dan *musyafahah* yang juga termasuk dalam kaedah *tasmik*. Oleh itu, guru dan murid seharusnya bekerjasama untuk memastikan kaedah *tasmik* ini dapat dilaksanakan secara kondusif dengan berusaha mengatasi kekangan-kekangan yang ada. *Tasmik* juga adalah pembeza utama perbuatan menghafal ayat-ayat al-Quran dengan perbuatan menghafal selain daripada al-Quran. Walaupun di peringkat rendah, *tasmik* lebih tertumpu pada program Khatam al-Quran, namun masih juga terdapat beberapa surah pilihan yang mesti dihafal oleh murid dalam bidang ayat-ayat hafazan berdasarkan sillibus Pendidikan Islam.

Falsafah Pendidikan Islam dibentuk berteraskan kepada wahyu Allah s.w.t. Hal ini bagi memastikan usaha pembentukan modal insan yang sejahtera di dunia dan bahagia di akhirat serta warganegara yang baik melalui pembelajaran bidang-bidang dalam Pendidikan Islam tercapai (Maimun Aqsha 2009). Oleh yang demikian, sebagai seorang guru perlulah melengkapkan diri dengan ilmu dan kemahiran yang secukupnya untuk memastikan objektif yang disasarkan tercapai di samping niat ikhlas mengajarkan al-Quran semata-mata mendapatkan keredhaan Allah. Matlamat untuk melahirkan generasi celik al-Quran sebagai wawasan jangka masa panjang akan dapat direalisasikan melalui model *tasmik* ini cuma memerlukan inisiatif daripada guru untuk menjadikannya lebih berkesan ketika dilaksanakan semasa PdPR. Kajian daripada Raja Abdullah dan Saidi Mohd (2018) juga mendapati bahawa tahap pengurusan serta kemahiran guru dalam menjalankan program ini berada pada tahap yang baik walaupun dalam norma baharu.

Justeru, adalah penting untuk memastikan pengajaran *tasmik* ini dirancang dengan teliti pelaksanaannya supaya impaknya akan melahirkan generasi muda yang mahir membaca dan mengamalkan ajaran al-Quran dengan baik. Di samping itu, pelaksanaan *tasmik* yang baik berupaya untuk menjadikan murid-murid terbentuk dengan soleh dan bertingkah laku yang sempurna di samping mempunyai pemikiran serta tindakan berlandaskan ketaatan kepada Allah s.w.t (Mohd Yusof 2005).

RUJUKAN

Abdul Hafiz bin Haji Abdullah dan Nursafazilah binti Maksom. (2016). Sistem Pengajaran dan Pembelajaran Madrasah Tahfiz al-Quran Darul Ta'alim, Kg Tengah Kluang. Dlm.

- Zulkifli Mohd Yakub bin Mohd Yusoff dan Nordin Ahmad (pnyt.). *Memperkasa Generasi Penghafaz al-Quran*. Darul Quran JAKIM: Selangor.
- Ahmad Mohd Salleh. (2011). *Kurikulum, Metodologi, dan Pedagogi Pengajian Islam*, Edisi Kedua, KPLI Pengajian Islam & j-QAF. Selangor: Oxford Fajar Sdn Bhd.
- Ainun Rahmah Iberahim, Zamri Mahamod & Wan Muna Ruzanna Wan Mohamad. (2017). Pembelajaran Abad Ke-21 Dan Pengaruhnya Terhadap Sikap, Motivasi dan Pencapaian Bahasa Melayu Pelajar Sekolah Menengah. *Jurnal Pendidikan Bahasa Melayu – JPBM (Malay Language Education Journal-MyLEJ)*, 7(2), 77-88.
- Anisa Ida Khusniyah. (2014). Menghafal al-Quran dengan metode *muraja'ah*. Studi kasus di rumah *tahfiz* al-Ikhlash Karangrejo Tulungagung. Skripsi Jurusan Pendidikan Agama Islam (PAI) Fakultas Tarbiyah Dan Ilmu Keguruan Institut Agama Islam Negeri (IAIN) Tulungagung.
- As'ad Humam, (2000). *Iqra' Cara Cepat Belajar Membaca Al-Quran*. Buku 1, Selangor: Pustaka Dini.
- Dr. Muhamad Sham bin Shahkat Ali. (2006). *ICT: Peranan dan Potensi dalam Pembangunan Pelajar*. Persidangan Pembangunan Pelajar Peringkat Kebangsaan Pelajar 2006 (NASDEC 2006) Universiti Teknologi Malaysia (UTM)
- Ehwan Ngadi. (2020). COVID19: Implikasi Pengajaran dan Pembelajaran Atas Talian. dari <https://www.usim.edu.my/news/in-our-words/covid19-implikasi-pengajaran-dan-pembelajaran-atas-talian/> [Diakses pada 30 Mei 2022]
- Hajarul Bahti Zakaria, Mohd Huzairi Awang @ Husain, Bani Hidayat Mohd Shafie, Nor Hayati Fatmi Talib. (2010). *Isu Dan Cabaran Guru Dalam Pendidikan Al-Quran Pelajar Bermasalah Penglihatan*. Proceedings of The 4th International Conference on Teacher Education.
- Harian Metro*. (2021). PdPR : Cabaran Guru, Pelajar dan Ibu Bapa. Diakses dari : <https://www.hmetro.com.my/mutakhir/2021/01/667475/pdpr-cabaran-guru-pelajar-dan-ibu-bapa> [24 Mei 2022]
- JAPIM. (2004). *j-QAF Buku Panduan Perlaksanaan Model-model Pengajaran dan Pembelajaran dan Kokurikulum*. Kuala Lumpur: KPM, h. 1.
- Kamarul Azmi Jasmi, Mohd Aderi Che Noh. (2013). *Sejarah, Kaedah, Serta Model Pengajaran dan Pembelajaran*. Kuala Lumpur.
- Maimun Aqsha Lubis. (2009). *Perbandingan Antara Falsafah Pendidikan Barat dengan Falsafah Pendidikan Islam*. Fakulti Pendidikan, Universiti Kebangsaan Malaysia.
- Mohd Ridhuan Mohd Jamil, Shariza Said & Mohd Ibrahim K. Azeez. (2014). Kompetensi guru terhadap pengurusan pengajaran dan pembelajaran: suatu pendekatan teknik fuzzy delphi. *Jurnal kepimpinan pendidikan*, 1(3), 77–88.
- Mohd Yusof Ahmad. (2005). *Sejarah dan kaedah pendidikan al-Quran*. Kuala Lumpur: Penerbit Universiti Malaya.
- Musliza Musa dan Mokmin Basri. (2014). *Perbandingan Kaedah Hafazan Al-Quran Tradisional Dan Moden: Satu Kajian Awal*. *Proceeding of the Social Sciences Research*. 9-10 June, Kota Kinabalu, Sabah.
- Nor Hidayati Mokhtar. (2020). *Pembelajaran atas talian untuk pembelajaran sepanjang hayat*. Ulasan Pakar UTM mengenai Isu Semasa Covid-19, Fakulti Sains Sosial Dan Kemanusiaan UTM. <https://news.utm.my/ms/2020/04/pembelajaran-atas-talian-untuk-pembelajaran-sepanjang-hayat/> [Diakses pada 1 Jun 2022]
- Roslinda Rosli. (2020). *Pembelajaran Norma Baharu Tingkat Profesion Guru Berita Harian Online* Ogos 11, 2020 @ 11:00am. Atas talian 29 Oktober. <https://www.bharian.com.my/> [Diakses pada 26 Mei 2022]

- YM Raja Abdullah bin Raja Ismail dan Saidi Mohd. (2018). *Model khatam al-Quran dan tasmik program j-QAF berdasarkan norma baharu guru Pendidikan Islam: tinjauan dalam daerah Kuala Nerus, Terengganu*. Seminar Kebangsaan PdPc Abad ke-21.
- Zetty Raihan Mohd Yassin. (2020). *Menangani cabaran norma baharu pembelajaran dan pengajaran era COVID-19*. Ulasan Pakar UTM mengenai Isu Semasa COVID-19. <https://news.utm.my/ms/2020/05/menangani-cabaran-norma-baharu-pembelajaran-dan-pengajaran-era-Covid-19/> [Diakses pada 26 Mei 2022]

Pembentukan Pemimpin Masa Depan Melalui Program Kepimpinan: Kajian Kes Parlimen Belia Malaysia

Nasrul Hakim Bin Salleh,
Universiti Malaysia Kelantan

Marwan Bin Ismail
Universiti Malaysia Kelantan

Noor Hisyam Bin Md Nawi
Universiti Malaysia Kelantan

ABSTRACT

The formation of leaders requires systematic and organized planning. The Ministry of Youth and Sports (KBS) has introduced the Malaysian Youth Parliament (PBM) program to form holistic leaders. A total of 9 PBM Committee Chairmen were interviewed in depth in a semi-structured manner to obtain data regarding the theme of PBM implementation requirements. Analysis of interview transcripts on the theme of PBM implementation requirements resulted in seven sub-themes namely; preparation of training, layering leaders, continuation of the country's survival, preparation of leaders at the initial stage, experience exposure, honing leadership talent and medium of youth participation. Atlas ti has been used to analyze interview data. Analysis of research data shows that the formation process of leaders requires a special program or platform that is systematic and structured to produce holistic leaders.

Keywords: *future leaders, Malaysian Youth Parliament, needs, holistic*

ABSTRAK

Pembentukan pemimpin pelapis memerlukan perancangan yang sistematik dan tersusun. Kementerian Belia dan Sukan (KBS) telah memperkenalkan program Parlimen Belia Malaysia (PBM) untuk membentuk pemimpin yang holistik. Seramai 9 orang Pengerusi Jawatankuasa PBM telah ditemubual secara mendalam separa berstruktur untuk mendapatkan data berkenaan tema keperluan pelaksanaan PBM. Analisa transkrip temu bual tema keperluan pelaksanaan PBM menghasilkan tujuh sub tema iaitu ; penyediaan latihan, pemimpin pelapis, penerus kelangsungan negara, penyediaan pemimpin di peringkat awal, pendedahan pengalaman, mengasah bakat kepimpinan dan medium penyertaan belia. Atlas ti telah digunakan untuk menganalisa data temubual. Analisa data kajian menunjukkan proses pembentukan pemimpin pelapis memerlukan program atau platform khas yang sistematik dan tersusun bagi melahirkan pemimpin yang holistik.

Kata Kunci: *pemimpin pelapis, Parlimen Belia Malaysia, keperluan, holistik*

PENDAHULUAN

Generasi belia berperanan sebagai pelapis yang menentukan hala tuju kemajuan negara pada masa hadapan kerana gerakan belia mampu mengubah landskap ekonomi, sosial dan politik negara (Nadine Abdala, 2016). Proses pembentukan kepimpinan belia merupakan salah satu daripada proses pembangunan belia positif (Lerner et al, 2015) yang memfokuskan kepada prinsip pembangunan belia (Mohd Mursyid, 2016). Menurut Hershatter dan Epstein (2010) pemimpin belia perlu mempunyai bakat yang hebat, berpengetahuan luas dan berkepakaran tinggi sebagai pemimpin. Justeru, pembangunan kepimpinan belia merupakan aspek penting yang diperlukan dalam agenda pembangunan negara seperti yang digariskan dalam Dasar Belia Malaysia 2015-2035 (DBM 2015) (Mohd Mursyid Arshad et al, 2018).

TINJAUAN LITERATUR

Penyertaan belia dalam pembangunan negara merupakan aspek penting yang perlu diberikan perhatian di peringkat nasional dan juga antarabangsa. Oleh itu, belia perlu mengetahui ruang yang membolehkan mereka melaksanakan hak-hak sivik dan politik serta menyumbang kepada proses pembuatan keputusan yang memberi impak terhadap kehidupan mereka dan negara (Mohd Uzaini Mohamad Sani & Suhana Saad, 2018). Pembangunan belia yang berstruktur dan mampan adalah penting untuk meneruskan agenda masa depan negara (Mohd Mursyid Arshad et al. 2015). Justeru, pendekatan dan pengisian pembangunan generasi belia di Malaysia memerlukan perubahan perancangan pembangunan belia. Pendekatan tersebut diperlukan bagi memastikan jaminan terhadap keupayaan generasi belia Malaysia menghadapi cabaran-cabaran yang bakal dihadapi dengan berkesan (Institut Penyelidikan dan Pembangunan Belia Malaysia 2015). Belia perlu ditanam dengan nilai-nilai kepimpinan agar menjadi peneraju masa hadapan yang berdaya saing dan mempunyai gaya kepimpinan yang unggul. Pembangunan belia terutamanya dalam bidang kepimpinan perlu diberi perhatian dan tumpuan yang sewajarnya (Ahmad Zaharuddin Sani Ahmad Sabri & Aainaa Zawani Ahmad Fu-ad, 2016). Pembangunan belia digambarkan sebagai satu proses yang berterusan untuk memenuhi keperluan fizikal dan tuntutan sosial dalam membina kompetensi belia (Delgado, 2002), yang sangat berpotensi dalam proses pembangunan belia positif (PYD) (Lerner et al., 2005; 2015).

METODOLOGI

Informan kajian ini adalah APBM yang terpilih melalui pilihanraya PBM dan memegang jawatan pengerusi atau setiausaha Jawatankuasa PBM. Kajian ini menggunakan kaedah sampel bertujuan (purposive) dan berstrata (stratified) (Airasian & Gray, 2003). Seramai Sembilan orang informan yang mewakili Sembilan jawatankuasa PBM telah ditemubual dengan menggunakan pendekatan temu bual mendalam separa berstruktur.

DAPATAN KAJIAN DAN PERBINCANGAN

Platform khas untuk menyediakan belia sebagai pemimpin pelapis perlu dirangka secara berstruktur demi memastikan Hasrat tersebut tercapai. Dapatan kajian menunjukkan bahawa informan menegaskan perlaksanaan PBM merupakan inisiatif tepat kerajaan untuk melahirkan pemimpin pelapis.

Penyediaan latihan

PBM berfungsi sebagai institusi latihan kepimpinan belia. Menurut IN4, peranan paling besar PBM ialah sebagai tempat penyediaan latihan kepada pemimpin belia. Analisis lanjut dapatan kajian mendapati tema penyediaan tempat latihan dapat dipecahkan kepada empat sub tema iaitu pemimpin pelapis, penerus kelangsungan negara penyediaan pemimpin diperingkat awal, supaya menjadi pemimpin yang hebat dan mengasah bakat kepimpinan.

“....PBM ini seperti tempat latihan kepimpinan. Biasanya dalam persatuan belia, kami dapat ilmu kepimpinan melalui bengkel-bengkel yang dianjurkan KBS. Jadi dalam konteks sekarang PBM jadi tempat latihan pemimpin belia seperti saya” IN4

Pemimpin pelapis

Belia merupakan pemimpin pelapis masa hadapan negara. Justeru, belia yang berpotensi menjadi pemimpin pada masa hadapan perlu dibentuk secara berstruktur untuk memastikan pemimpin belia mampu mengalas tugas mengemudi negara pada masa hadapan. IN6 menyatakan pemimpin belia hari ini adalah pemimpin pelapis negara pada masa akan datang. Pandangan tersebut turut disokong oleh IN3, IN4, IN5 dan IN7 yang menyatakan belia merupakan aset negara yang perlu dibentuk untuk menjadi pemimpin pelapis negara pada masa hadapan.

“Kalau kita lihat perkembangan semasa, banyak program untuk belia seperti kami. Sudah banyak program yang kerajaan laksanakan untuk golongan belia. pada saya tend ini berlaku kerana kerajaan sedar belia adalah pemimpin masa hadapan” IN3

Penerus kelangsungan negara

Kemajuan dan kelangsungan negara bergantung sepenuhnya kepada modal insan yang dipunyai oleh sesebuah negara pada masa sekarang. Modal insan dalam konteks tersebut merujuk kepada generasi belia. Kegagalan menyediakan belia sebagai pemimpin masa hadapan bermakna seperti meletakkan negara dalam kehancuran pada masa akan datang.

“jatuh bangun sangat bergantung kepada pemimpin. Kalau pemimpin gagal urus negara dengan baik, boleh jadi hancur negara itu. So, kena bentuk daripada awal lagi pemimpin pelapis ni. Sekarang banyak negara dipimpin oleh orang muda” IN5

Fakta menunjukkan bahawa negara maju seperti Amerika Syarikat, German dan Perancis terus maju kerana berjaya membentuk pemimpin belia yang disediakan untuk terus memacu kelangsungan negara.

Penyediaan pemimpin di peringkat awal

Informan turut menyatakan bahawa perlaksanaan PBM merupakan langkah awal untuk melatih belia menjadi pemimpin pelapis. Perkara tersebut bersesuaian dengan objektif PBM yang berhasrat menyediakan proses latihan kepimpinan peringkat awal kepada belia (Mohd Uzaini, 2018).

“Objektif PBM sendiri pun adalah sebagai tempat latihan awal kepimpinan. Bukan mudah mahu jadi pemimpin. Itu kami sedar, kerana itulah apabila ada PBM ini saya tidak lepaskan peluang. I grab this oppurtinity” IN9

PBM merupakan platform yang sesuai dan tepat untuk melahirkan pemimpin belia yang mewakili suara akar umbi belia.

“Parlimen belia merupakan platform terbaik untuk membentuk pemimpin belia yang betul-betul membawa suara belia. Memang ada program kepimpinan lain untuk pemimpin belia seperti fello perdana. Tapi fello perdana ini lebih kepada pembangunan sendiri pemimpin itu sahaja,, bersifat eksekutif, tidak melibatkan two way communication dengan akar umbi belia” IN7

Dalam PBM politik kepartian tidak diamalkan sama sekali. Unsur-unsur politik kepartian tidak dibawa dalam PBM walaupun Ahli Parlimen Belia mempunyai sudut

pandangan yang tersendiri mengenai lansdskap politik negara. Kesemua informan menyatakan bahawa PBM hanya menfokuskan isu-isu berkaitan pembangunan belia sahaja.

“Saya tak nafikan ahlim parlimen belia ada fahaman politik masing-masing. Ada yang sokong kerajaan, ada yang sokong pembangkang, ada yang tidak minat mana-mana parti politik. Tapi dalam PBM isu politik kepartian kami tidak pernah timbulkan. Perbezaan fahaman politik hanya berlaku diluar sidang PBM sahaja. Dalam PBM kami betul-betul fokus pada isu pembangunan belia. Kami gunakan sepenuhnya peluang yang ada ni” IN6

Pendedahan pengalaman

Dalam proses pembangunan kepimpinan, pendedahan pengalaman merupakan aspek yang penting untuk memberikan kefahaman yang lebih jelas kepada belia mengenai proses kepimpinan (Mohd Mursyid, 2016). Dapatan kajian mendapati informan menyatakan pelaksanaan PBM telah memberikan pendedahan dan pengalaman kepimpinan kepada mereka. Menurut IN1, proses perjalanan PBM yang bersifat seperti parlimen sebenar telah memberikan gambaran yang jelas mengenai perjalanan menguruskan negara.

“Perjalanan PBM sama seperti perjalanan parlimen Malaysia. Ada persidangan, bahas usul dan pengundian usul. Perbahasan usul adalah perkara yang paling suka. Saya akan ambil bahagian penuh, beri perhatian dan turut sama berbahas. Rasa seperti ahli parlimen sebenar. Baru saya rasa, mungkin macam ni perasaan ahli parlimen Malaysia” IN1

Kesemua informan yang ditemui pengkaji menyatakan pendedahan pengalaman merupakan ilmu yang sangat penting untuk pemimpin belia belajar dan berpeluang dan terlibat secara langsung dalam proses kepimpinan. IN8 menyatakan ;

“saya bolehkan katakan banyak benda yang saya pelajari sepanjang terlibat dengan parlimen belia ni. Saya belajar bagaimana sesuatu usul itu dibentuk, dibahas dan diluluskan. Saya turut berpeluang duduk semeja dengan menteri berbincang mengenai isu-isu berkaitan pembangunan belia. saya rasa pengalaman yang saya dapat tu cukup mahal” IN8

Mengasah bakat kepimpinan

Penyediaan institusi latihan kepimpinan yang berstruktur mampu mengasah bakat kepimpinan kumpulan sasaran dengan lebih berkesan (Mumford, 2010). Pelaksanaan PBM telah memberikan peluang sepenuhnya kepada pemimpin belia mengasah bakat kepimpinan. Menurut informan, peluang tersebut telah digunakan untuk mengasah bakat kepimpinan yang ada pada mereka.

“Kepimpinan ini unik. Ada orang kata pemimpin lahir dengan bakat, dilahirkan untuk jadi pemimpin. Saya tidak setuju dengan kenyataan itu. Semua orang ada bakat jadi pemimpin, Cuma mungkin tidak ada peluang. Contohnya parlimen belia ni, sangat berguna untuk mengasah bakat kepimpinan. Kalau ada bakat ekali pun, tapi tidak tempat mahu asah bakat, tidak kemana jgk”IN1

Informan menyatakan terdapat APBM yang terpilih menjadi calon dalam pilihanraya umum ke lima belas (PRU14) yang lepas. Perkara tersebut membuktikan bahawa pemimpin belia sudah mendapat kepercayaan pemimpin dewasa untuk turut serta dalam proses kepimpinan negara.

“Ramai kawan-kawan saya dari parlimen belia yang mejadi calon dalam PRU14 yang lepas. Bagi saya perkembangan tersebut sangat positif. Kami sebagai pemimpin belia sudah mula mendapat tempat dalam parti politik” IN2

Melalui PBM informan berpeluang mempraktikkan ilmu komunikasi pengucapan awam seperti berpidato dan berbahas. IN9 menyatakan PBM menjadi platform terbaik pemimpin belia mengasah kemahiran komunikasi pengucapan. Malah IN7 turut menyatakan APBM mempunyai kualiti yang lebih baik dalam aspek pengucapan awam berbanding dengan Ahli Parlimen.

“terus terang saya katakan ahli parlimen belia jauh lebih berkualiti dalam aspek pengucapan awam. saya dan pengerusi jawatankuasa lain diberikan peluang untuk hadir dalam sesi persidangan Dewan Rakyat untuk melihat sendiri proses persidangan Dewan Rakyat. Saya lihat ada ahli parlimen yang bercakap entah apa-apa. Yang tak dapat berucap dalam bahasa Melayu yang fasih pn ada. Dalam PBM ada ahli parlimen belia yang bukan Melayu, tapi boleh berucap dengan sangat fasih. Kalau kita pejam mata sambil dengar ucapan itu, mesti kita fikir orang Melayu yang sedang berucap” IN9

Medium penyertaan belia

Hasrat utama perlaksanaan PBM adalah untuk memberikan peluang kepada pemimpin belia untuk turut terlibat sama dalam pengubalan dasar berkaitan pembangunan belia. Penglibatan belia dalam pengubalan dasar kerajaan adalah amat penting untuk memastikan dasar yang dirangka adalah bersesuaian dengan keperluan belia.

“Tujuan utama PBM adalah untuk membantu kerajaan merangka dasar-dasar berkaitan belia. corak kepimpinan diseluruh dunia sudah banyak berubah. Negara-negara maju telah mula melibatkan belia dalam proses pembuatan dasar. Malaysia pun turut mengambil langkah sama. Isu penglibatan belia dalam pembuatandasar ini, perkara yang cukup besar” IN6

Penyertaan belia yang tinggi dalam pembentukan dasar kerajaan menjadi faktor kejayaan kepada perlaksanaan dasar tersebut kerana kerajaan berupaya memahami kehendak dan keperluan sebenar belia di peringkat akar umbi.

“Sebarang dasar pembangunan belia mestilah melibatkan pandangan belia di peringkat grass root. Bukan suka-suka ikut rasa kementerian yang terlibat. Perlu ada satu kajian mendalam di peringkat akar umbi untuk memahami apa sebenarnya yang belia mahu. Sebagai contoh, salah satu usul yang kami bawa iaitu E-sport. Usul itu kami dapat hasil daripada pertemuan dan perbincangan dengan belia di peringkat bawah. Alhamdulillah usul itu diluluskan, malah usul tersebut telah pun dilaksanakan oleh kerajaan. Kalau tak silap saya kerajaan telah memperuntukan RM20 juta dalam pembentangan bajet untuk E-sport” IN6

Selain itu, IN4. Dan IN8 menyatakan PBM menjadi medium dan penghubung untuk pemimpin belia mendapatkan pandangan daripada belia di peringkat akar umbi kerana berdasarkan unjuran data yang dikeluarkan oleh KBS hanya 20% sahaja belia yang terlibat dengan persatuan. Manakala selebihnya 80% merupakan belia tidak berpersatuan.

“sebenarnya kalau ikut data, hanya 20% sahaja belia yang terlibat dengan persatuan. Yang tidak terlibat dengan persatuan belia masih terlalu ramai, jumlah 80% ni bukan sedikit tau. Kita sekarang lebih tumpu kepada belia yang berjaya. Ramai belia yang dropout dari sekolah. Bagaimana dengan nasib mereka? Siapa

yang akan dengar suara mereka. Dalam konteks ini, saya rasa PBM cukup berperanan sebagai medium untuk golongan tersebut menyuarakan pandangan mereka” IN8

KESIMPULAN

Inisiatif Kementerian Belia dan Sukan (KBS) memperkenalkan program kepimpinan khas seperti Parlimen Belia merupakan langkah tepat untuk melahirkan pemimpin pelapis yang holistik. Proses penyediaan generasi belia sebagai pemimpin merupakan proses berterusan yang perlu sentiasa memerlukan penambahbaikan sepanjang masa.

RUJUKAN

- Ahmad Zaharuddin Sani Ahmad Sabri & Aainaa Zawani Ahmad Fu-ad. (2016). Usha kerajaan ke arah pemantapan kepimpinan dalam pembangunan belia di Malaysia. *Journal on Leadership & Policy*. Volume1/2016.
- A.R Syaidatull Erni Zakiah, Razli Che Razak & Derweanna Bah Simpong. (2016). The influence of social media, social engagement and voluntterism towards university`s youth leadership participation in East Cost, Malaysia : A conceptual paper. *Journal of Applied Sciences* 11(11) : 1344-1349, 2016.
- Checkoway, B., and L. Gutierrez. (2006). Youth participation and community change: An introduction. *Journal of Community Practice* 14 (1): 1–9.
- Dasar Belia Malaysia. (2015). Institut Penyelidikan dan Pembangunan Belia Malaysia. Putrajaya : Kementerian Belia dan Sukan Malaysia
- Khairunesa Isa & Mohamed Azrul Syam Mohamed Yusof. (2011). Penyertaan belia dalam aktiviti Gerakan Belia 4B di komuniti Petaling Jaya Selatan, Selangor Darul Ehsan. PERSIDANGAN KEBANGSAAN SAINS SOSIAL UNIMAS 2011: Pembangunan ke Arah Masa Depan yang Mapan 20-21 April 2011 CTF1 Kampus Barat, Universiti Malaysia Sarawak
- Larson, R. W., & Angus, R. (2011). Pursuing paradox: The role of adults in creating empowering settings for youth. In M. Aber, K. Maton, & E. Seidman (Eds.), *Empowering settings and voices for social change* (pp. 65 – 93). New York: Oxford University Press
- Mohd Mursyid Arshad., Ismi Arif Ismail., Turiman Suandi., & Zoharah Omar. (2017). Linking Mentoring within a Community of Practice to Positive Youth Development among Participants of a Youth Leadership Program in Malaysia. *International Journal of Academic Research in Business and Social Sciences*, 7(8), 642-648. doi: 10.6007/IJARBS/v7-i8/3270
- Mohd Uzaini Mohamad Sani & Suhana Saad. (2018). Perlaksanaan dan Cabaran Penglibatan Belia Dalam Parlimen Belia Malaysia. *Journal of Social Science and Humanities*,13 (1): 1-17
- Wu, H-C., Akiva, T. & Van Egeren, L. (2014). Development of Leadership Conceptions among Adolescents in Youth-Adult Partnership Programs. Paper presented at 2014 Society for Research on Adolescence Conferenc
- MacNeil, C. A. (2006). Bridging generations: Applying “adult” leadership theories to youth leadership development. *New Directions for Youth Development*, 2006(109), 27-43. doi:10.1002/yd.153
- Safiah Suhaimi, 2Rozita Arshad, 3Asmah Laili Yeon (2018). YOUTH PARTICIPATION IN DECISION MAKING IMPROVE LEADERSHIP SKILLS. *International Journal of Social Science and Economic Research*. Volume:03, Issue:07 "July 2018"

Institut Penyelidikan Pembangunan Belia Malaysia (IYRES). 2015. Kajian Pembangunan Kesejahteraan, Aset Belia Malaysia. Putrajaya.

[Elizabeth Smythe](#), [Andrew Norton](#). [Thinking as Leadership/Leadership as Thinking](#). Leadership, vol. 3, 1: pp. 65-90. , First Published Feb 1, 2007.



UNIVERSITI



MALAYSIA

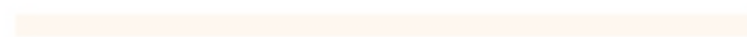

KELANTAN

Pembudayaan Inovasi Pengajaran Guru Pendidikan Islam dari Pemikiran Ibnu Khaldun

Siti Hazlini Binti Haris
Universiti Pendidikan Sultan Idris
hazlini86@gmail.com

Norhisham Bin Muhamad
Universiti Pendidikan Sultan Idris
nhisham@fsk.upsi.edu.my

ABSTRACT

Innovation is the catalyst of change. Teachers' acceptance of innovation is an aspect that is discussed and studied by many researchers, whether Islamic or western scholars. This is in line with the flow of time in the 4.0 industrial revolution. Therefore, this concept paper highlights the culture of teaching innovation among Islamic Education teachers from the perspective of Ibn Khaldun's thinking which is very synonymous with him as a sociological figure. Ibn Khaldun is a respected Islamic scholar. Kitab Muqaddimah is one of his famous works that discusses human civilization, politics, sociology, society and education. According to Ibn Khaldun, culture is civilization. Human action is born through thought. The discussion about the culture of the functionality of the human mind by Ibn Khaldun brought the culture of thought (Aql) to better appreciate, take wisdom and associate with the divine which ultimately leads to the civilization based on Islamic law.

ABSTRAK

Inovasi adalah pencetus perubahan zaman. Penerimaan guru terhadap inovasi merupakan aspek yang menjadi perbincangan dan kajian oleh ramai pengkaji sama ada sarjana Islam atau Barat. Ini bersesuaian dengan peredaran arus masa dalam revolusi industri 4.0. Oleh hal yang demikian, kertas konsep ini mengetengahkan pembudayaan inovasi pengajaran di kalangan guru Pendidikan Islam dari sudut pemikiran Ibnu Khaldun yang sangat sinonim dengan beliau sebagai tokoh sosiologi. Ibnu Khaldun merupakan tokoh sarjana Islam yang disegani dan dihormati. Kitab Muqaddimah merupakan antara karya beliau yang masyhur yang membincangkan tentang peradaban manusia, politik, sosiologi, kemasyarakatan dan pendidikan. Menurut Ibnu Khaldun, pembudayaan ialah peradaban dan perubahan dalam tamadun. Tindakan manusia lahir melalui pemikiran. Kemampuan berfikir akan melahirkan budaya. Pembahasan tentang budaya kefungsi-an akal manusia yang dibawa Ibnu Khaldun membawa budaya pemikiran (Aql) untuk lebih menghayati, mengambil hikmah dan mengaitkan dengan ketuhanan yang akhirnya membawa kepada pembudayaan peradaban berlandaskan hukum Islam.

PENDAHULUAN

Ledakan globalisasi dan kepesatan teknologi masa kini telah merubah perkembangan dunia termasuk dunia pendidikan. Maka, sepatutnya sistem pendidikan memerlukan pembaharuan bukan sahaja dalam bidang teknologi, namun dalam aspek pengetahuan serta aplikasi dalam pengajaran (Norazilawati Abdullah, 2020). Inovasi merupakan perkataan daripada bahasa Latin yang membawa maksud pembaharuan. (Nazariyah, 2014). Menurut Wan Ali Akbar, Khadijah Abdul Razak & Isa Hamzah, (2020a), Allah merupakan inovator atau pencipta yang pertama di muka bumi. Hal ini terbukti apabila Allah memerintahkan “jadi”, maka perintah itu

menunjukkan ada sesuatu yang diperintahkan untuk terjadi sebagaimana berdasarkan firman Allah dalam surah al-Baqarah ayat 117:

بَدِيعُ السَّمٰوٰتِ وَالْاَرْضِ وَاِذَا قَضٰى اَمْرًا فَاِنَّمَا يَقُوْلُ لَهُ كُنْ فَيَكُوْنُ

Maksudnya: “Jadi” maka jadilah ia (surah al-Baqarah, 2:117).

Oleh itu, transformasi guru terhadap kaedah pengajaran adalah perlu, seiring dengan perubahan iklim dunia yang semakin kompetitif. (Wan Ali Akbar, Khadijah Abdul Razak & Isa Hamzah, 2020b; Jessica Dora & Zamri Mahamod, 2021). Usaha untuk berinovasi hendaklah dibiasakan atau dibudayakan dalam kalangan guru Pendidikan Islam (Azrina Sobian, 2011). Proses pendidikan sentiasa sinonim dengan aktiviti perubahan. Maka, inovasi dalam pendidikan harus relevan dengan perkembangan zaman (Wan Mariana Wan Mohamad, Kamarul Shukri Mat Teh & Wan Ali Akbar Wan Abdullah, 2021). Inovasi pengajaran merupakan suatu pembaharuan kreatif guru Pendidikan Islam dimana kaedah atau cara yang baharu digunakan bagi seseorang GPI untuk memastikan objektif pengajarannya tercapai. (Wan Ali Akbar et. al, 2021). Oleh itu, teori pemikiran Ibnu Khaldun ditelusuri sebagai penanda aras dalam pembangunan peradaban atau pembudayaan inovasi.

BIODATA IBNU KHALDUN

Nama penuhnya ialah Abd Al Rahman bin Muhammad bin Muhammad bin Muhammad bin Al Hassan bin Muhammad bin Jabir bin Muhammad bin Ibrahim bin Abd Rahman bin Khaldun. Ibnu Khaldun dilahirkan di Tunisia pada bulan Ramadan 732H/1332M. Beliau dikenali dengan nama Ibnu Khaldun diambil daripada nama datuknya iaitu Khalid bin Usman yang dikenali sebagai Khaldun dan keluarga dipopularkan sebagai gelaran Bani Khaldun. (Mohd Zahirwan et al., 2017). Manakala gelaran intelektualnya ialah Wali al Din merujuk kepada jasa-jasa dan peranan beliau ketika memegang jawatan di Jabatan Kehakiman Mesir dan digelar sebagai *Guardian of the Religion* (Mohd Syaubari Othman, 2019).

Ibnu Khaldun merupakan keturunan keluarga yang masyhur dan terkenal. Bapanya merupakan guru pertamanya. Pendidikan awal Ibnu Khaldun ialah membaca al-Quran dan mempelajari hadis. Mendapat pendidikan formal di tempat lahirnya Tunis selama 18 tahun (Mohamad Zarkhuan Zainol, 2020). Beliau memulakan di Tunis apabila Ibnu Tafrakin menawarkannya jawatan sebagai pembawa mohor kepada Sultan Abu Ishaq (Mohamad Abdullah Enan, 2014).

Ibnu Khaldun dikenali dan dihormati hingga kini menerusi karya agung peninggalannya iaitu Muqaddimah. Kitab inilah yang menjadi rujukan awal dalam bidang sosiologi, politik, falsafah, ekonomi, pendidikan dan sebagainya. Sehingga kini, penelitian dan pemikiran beliau masih kekal relevan (Muhsin Mahdi, 2014).

FAKTOR-FAKTOR PEMBUDAYAAN INOVASI PENGAJARAN

Persepsi Guru

Jiwa yang rasional membuat persepsi dan menimbulkan tindakan melalui tindakan. Menurut Ibnu Khaldun (2002), manusia pada asalnya jahil tetapi mampu berubah dengan kemampuan berfikir yang akan membentuk pengetahuan. Seterusnya, pengetahuan ini akan diperkembangkan daripada asas sesuatu disiplin ilmu kepada suatu yang lebih terperinci iaitu kefahaman. Kefahaman bermaksud seseorang individu menguasai dan benar-benar mendalami sesuatu disiplin ilmu pengetahuan. Kefahaman ini adalah berasaskan kepada aspek berfikir,

menganalisis dan membentuk sesebuah konsep. Mohd Fahmi (2016) menyatakan bahawa kefahaman bermaksud kesediaan mental guru untuk belajar hal-hal yang berkaitan.

Oleh itu, kedua-dua tafsiran ini menjelaskan bahawa minat berkait langsung dengan persepsi seseorang. Namun, persepsi seseorang dipengaruhi oleh beberapa faktor. Salah satu sebab ialah pendirian tidak mahu turut terlibat. Jika seseorang itu tidak menerima sesuatu maklumat, ia akan menyumbang kepada pemikiran kritis untuk menerima maklumat tersebut. Namun, jika seseorang memihak kepada sesuatu pendapat, maka dia akan menerima serta merta setiap maklumat. Sikap buruk sangka akan menghalang seseorang daripada berfikir secara kritis. Akibatnya, sesuatu yang tidak sahah diterima dan disampaikan. (Ibnu Khaldun, 2002).

Faktor kedua ialah kerana terlalu bergantung kepada maklumat yang diceritakan oleh orang lain. Faktor seterusnya ialah kerana tidak menyedari tujuan sesuatu kejadian. Sebab yang keempat ialah andaian yang tidak berasas tentang kebenaran sesuatu hal. Ia berlaku disebabkan mempercayai maklumat yang disampaikan. Seterusnya ialah ketidaktahuan tentang bagaimana keadaan itu sesuai dengan realiti (Ibnu Khaldun, 2002).

Faktor minat guru turut mempengaruhi perubahan sama ada dari dalam, atau dari luar, ataupun melibatkan kedua-duanya. Motivasi ekstrinsik ialah motivasi yang berkait rapat dengan pengukuhan. Pengukuhan ini lazimnya dipanggil ganjaran. Ia merupakan rangsangan atau motivasi yang diwujudkan daripada ganjaran luar yang diberikan setelah sesuatu pekerjaan atau tugas dapat dilaksanakan dengan sempurna. Keinginan untuk menerima penghargaan daripada orang lain atau menerima ganjaran seperti hadiah, sijil, wang dan bonus. (Wan Ali Akbar et. al, 2020b).

Setiap orang memerlukan penilaian yang tinggi dan stabil tentang diri mereka. Oleh itu, mereka perlu menghormati diri sendiri dan dihargai oleh orang lain. Keperluan ini dapat dipenuhi apabila seseorang itu mempunyai keyakinan diri, pengiktirafan, perhatian dan penilaian daripada orang lain (Saedah Siraj et; al, 1996). Antara faktor yang boleh menghalang minat terhadap inovasi ialah faktor tekanan masa berlebihan. Isu tekanan masa adalah berkaitan dengan isu tekanan kerja dalam kalangan guru kini kian mendapat perhatian orang ramai dalam dan luar organisasi pendidikan. Keluhan yang sering kedengaran ialah guru dibebani kerja bukan di dalam ruang tugasnya (Abdul Said Ambotang & Norhayati Bayong, 2021).

Ternyata, tekanan kerja mengganggu gaya hidup seterusnya mempengaruhi pengurusan masa GPI. Usaha untuk menghabiskan standard kandungan dalam masa yang terhad menjadikan GPI kurang memikirkan inovasi dalam penyampaian mereka (Mohd Sayubari Othman & Yunus Ahmad Kasim, 2021). Terdapat juga persepsi GPI bahawa perubahan berkait rapat dengan penambahan beban tugas. Masa akan bertambah untuk menghasilkan inovasi. Perubahan dianggap menyusahkan justeru GPI tidak mahu menyusahkan diri mencuba, meneroka dan mengambil risiko mencuba inovasi dalam kelas kerana wujud kebimbangan bahawa inovasi memerlukan masa yang lama untuk menghasilkan sesuatu yang canggih (Mohd Hasril Amiruddin & Alias Masek, 2014). Motivasi intrinsik merupakan keinginan seseorang yang kuat untuk melaksanakan sesuatu disebabkan minat yang didorong oleh tanggapan dalam diri tentang kepentingan tugas tersebut kepada dirinya. Guru yang memiliki motivasi intrinsik akan menentukan matlamatnya dan akan berusaha untuk mencapai matlamat tersebut. (Saedah Siraj et; al, 1996).

Matlamat merupakan elemen yang penting kerana dengan matlamat tersebut, akan lahirnya dorongan dalaman. (Wan Ali Akbar et. al; 2020a). Jika seseorang mempunyai keperluan atau kemahuan terhadap sesuatu, individu tersebut akan berusaha mendapatkannya demi kepuasan diri (Chua Yan Piaw, 2014). Guru terpaksa melaksanakan kerja-kerja dari segi perancangan untuk mengajar, kerja-kerja perkeranian, kegiatan kokurikulum, dan menghadiri mesyuarat. Keadaan ini menyebabkan berlakunya ketidakpuasan bekerja di kalangan guru kerana merasa diri mereka dalam kelesuan (Mulyati Timbang & Abdul Said Ambotang, 2020).

Peranan Pentadbir

Peradaban ialah permulaan dan pengakhiran perkembangan sosial dan organisasi politik. Manusia dilahirkan bersifat sosial secara semula jadi (Ibnu Khaldun, 2002). Menurut Dr Wahbah Zuhaili, (1997), pembangunan peradaban berada di bawah pemerintah kerana mereka adalah orang yang membuat keputusan. Budaya organisasi memainkan peranan penting dalam inovasi. Pemimpin perlu membuktikan yang mereka menghargai kreativiti dan bersedia bertindak menggunakan idea yang dirasakan boleh mendatangkan manfaat kepada organisasi (Nur Jannah Keman et. al;2021). Kajian menunjukkan inovasi gagal kerana pentadbir kurang melibatkan diri secara berkesan dalam pelaksanaan inovasi. Ciri-ciri pemimpin yang menggalakkan inovasi ialah berinovatif, kreatif, sentiasa bersedia mencari alternatif, berinisiatif, fleksibel dan sanggup mengambil risiko (Abdul Said Ambotang & Norhayati Bayong, 2018).

Ini lebih ketara sekiranya pihak pentadbir atau guru besar tidak tahu menghargai jasa, sumbangan dan peranan guru. (Nur Jannah Keman et. al, 2021). Kepimpinan pentadbir yang bersifat autokratik dan mengamalkan “dasar tertutup” dalam mewujudkan komunikasi dan hubungan dengan guru juga semakin menjarakkan guru dengan pengurusan sekolah sedangkan guru banyak sumbangan kepada sekolah secara sukarela tetapi tidak mendapat penghargaan atau sebarang maklum balas (Zaidi Saleh, et al; 2021).

Kompetensi kepimpinan yang cekap, dan berwibawa adalah penting untuk menggerakkan sesuatu organisasi. Pemimpin sekolah itu hendaklah memberikan perhatian kepada suasana tempat kerja, selain memainkan peranan besar dalam merangsang iklim demi membudayakan penghasilan inovasi pengajaran di kalangan guru (Mohamad Rasyiq Mohamad Noh et. al, 2021).

Kolaborasi Ilmu

Ibnu Khaldun juga menegaskan bahawa proses pembelajaran melalui perbincangan dan perkongsian pengalaman merupakan salah satu kaedah untuk menambah ilmu pengetahuan (Ibnu Khaldun, 2002). Memandangkan terdapat kekangan yang wujud dari sudut keterbatasan ilmu dan kemahiran, maka kolaboratif merupakan jalan penyelesaian terbaik. Konsep kolaboratif juga dizahirkan oleh KPM melalui program *Professional Learning Community* (PLC) (KPM, 2018). Allah menggesa agar manusia bertanya *ahli zikr* jika tidak mempunyai sesuatu pengetahuan.

وَمَا أَرْسَلْنَا مِنْ قَبْلِكَ إِلَّا رِجَالًا نُوحِي إِلَيْهِمْ فَسَلُّوا أَهْلَ الدِّكْرِ إِنْ كُنْتُمْ لَا تَعْلَمُونَ

(Surah an-Nahl:43)

Maksudnya: Dan Kami tidak mengutus sebelum kamu, kecuali orang-orang lelaki yang Kami beri wahyu kepada mereka; maka bertanyalah kepada orang yang mempunyai pengetahuan jika kamu tidak mengetahui

BUDAYA INOVASI PENGAJARAN

Daya olah fikiran manusia dibentuk oleh persekitaran, yang akan membentuk sistem. Sistem ini akan membentuk kebudayaan (Ibnu Khaldun, 2002). Ibnu Khaldun mempunyai falsafah yang menarik tentang akal dan fikiran yang membezakan manusia dan haiwan. Manusia secara zatnya adalah jahil tetapi alim daripada segi usahanya melalui kemampuan berfikir. Berfikir (*Fikr*) ialah aplikasi akal dalam membuat analisis dan sintesis. Kemampuan manusia untuk berfikir adalah anugerah khusus semulajadi ciptaan Allah. Berfikir juga bererti permulaan tindakan manusia yang teratur dan tertib (Ibnu Khaldun, 2002).

Menurut Ibnu Khaldun (2002), seseorang itu akan cuba untuk mendapatkan pelbagai ilmu kemudian berusaha untuk menambah ilmu yang baharu. Hasil daripada proses yang melibatkan pertukaran ilmu serta kesannya terhadap pemikiran dan tingkahlaku individu inilah yang dikenali sebagai amalan atau tabiat yang menjadi kebiasaan. Setiap kebiasaan itu bersifat budaya (*thaqafah*) sama ada pada jasad, corak dan sebagai hasil kemampuan seseorang berfikir.

“Permulaan sesuatu tindakan adalah berakhirnya kerja berfikir dan apa yang dimaksudkan berfikir ialah berakhirnya tindakan” (Ibnu Khaldun, 2002).

Berdasarkan kata hikmah ini, beliau memberi contoh seorang insan yang berfikir untuk membuat atap atau bumbung rumah bagi bagi tujuan berlindung dari hujan dan panas, dia akan mengarahkan pemikirannya supaya didirikan tiang dan dinding terlebih dahulu untuk menjadi penyangga kepada bumbung yang akan dibuat. Di sini, kerja berikutnya akan berakhir dan dia akan bekerja untuk menyiapkan tapaknya kemudian beralih kepada dinding, seterusnya kepada bumbung yang mana usahanya berakhir (Ibnu Khaldun, 2002).

Dalam membicarakan kata-kata hikmah ini, Ibnu Khaldun berpendapat ilmu perlu menjadi malakah atau kemahiran dan kecekapan. Oleh itu, malakah ditkrifkan sebagai kebiasaan atau budaya. Budaya berfikir (*Thaqafah Fikr*) ini dibahagikan kepada empat peringkat.

***Aql tamyiz* (budaya menganalisis)**

Peringkat pertama ialah tanggapan atau persepsi terhadap sesuatu perkara (*Aql Tamyiz*). Peringkat ini membolehkan akal melakukan perbezaan yang melaluinya manusia memperoleh segala sesuatu yang bermanfaat bagi diri dan kehidupannya, serta menolak perkara-perkara yang memudaratkannya (Ibnu Khaldun, 1993).

Ibn Khaldun menyatakan bahawa keistimewaan manusia yang dimaksudkan adalah potensi fikiran yang berfungsi mengidentifikasi objek atau suatu masalah yang disebut *Aql tamyizi*. (Ibnu Khaldun, 2002). Menurut Moh. Pribadi (2017), hal ini bermaksud pada peringkat pertama ini individu mampu untuk mengenal pasti masalah, membezakan masalah dan mencari jalan untuk menyelesaikan masalah. Ia mempunyai perkaitan dengan kemahiran menganalisis iaitu bagaimana pemikiran digunakan untuk menentukan, membanding beza, mengkategorikan dan mengklasifikasikan berdasarkan nilai pertimbangan yang mendatangkan kebaikan dan keburukan (Mohd Syaubari et. al, 2022).

***Aql Tajribi* (budaya mencipta)**

Peringkat kedua ialah pengalaman di mana gabungan idea daripada tanggapan yang kebanyakannya diperoleh melalui pengalaman sehingga ia dirasakan bermanfaat (*Aql Tajribi*). Ibnu Khaldun (2002), menyatakan dalam peringkat ini, kemampuan akal adalah pada tahap intelektual eksperimen atau ia mempersepsikan tentang sesuatu yang ada, baik secara abstrak atau maujud (*ghaiban wa syahidan*). Kemampuan manusia ini dapat membantunya untuk menyerap idea yang disebut *al- aql al-Tajribi*.

Idea dan tingkah laku yang diperlukan di dalam menangani masalah sesama manusia dan memimpin mereka (Ibn Khaldun, 1993).

Akal ini mempunyai persamaan dengan kemahiran mencipta sebagaimana dihuraikan oleh Rosenthal, (2005):

The idea and the behaviour needed in dealing with his fellow men and in leading them

Akal eksperimental ini dicapai sesudah akal pembeza yang membimbing pada tindakan. Dengan pengetahuannya yang merupakan hasil usahanya, dinamakan *aql tajribi* kerana lahirnya ilmu pengetahuan melalui percubaan, pengalaman dan pengulangan (Ibnu Khaldun, 2002). Dari sudut Bahasa, *Tajribi* bermaksud percubaan (Kamus Dewan Edisi Keempat). Sekiranya dikaitkan dengan kemahiran menghasilkan inovasi, pemikiran ini disamakan dengan mencipta iaitu melalui percubaan akan menghasilkan ilmu pengetahuan yang baharu.

***Aql Nazari* (budaya mengaplikasi)**

Peringkat yang ketiga pula ialah pengetahuan andaian (*Aql Nazari*). Dengan adanya pelbagai pengalaman dan ilmu, maka pada peringkat ini, seseorang individu mampu untuk membuat perbandingan bagi menghasilkan pengetahuan baharu (Ibnu Khaldun, 2002). Peringkat ini bersamaan dengan kemahiran mengaplikasi iaitu kombinasi daripada keseluruhan idea, gambaran, pengamatan dan tanggapan akan membentuk suatu pengetahuan, tingkahlaku atau pemikiran yang baharu (KPM, 2014).

***Hakikat Insaniyah* (budaya menilai)**

Peringkat keempat ialah gabungan tanggapan dan pengalaman yang terbentuk menjadi kesempurnaan (*Hakikat Insaniyah*) (Ibnu Khaldun, 2002). Peringkat ini disamakan dengan kemahiran menilai dalam menghasilkan inovasi. Proses penilaian ini berupaya membentuk hala tuju yang tepat. Matlamat kehidupan yang bersendikan aturan syariat telah menjadikan proses berfikir berada di dalam lingkaran nilai agama dan berupaya membentuk insan yang berkarisma dan bertauhidkan Allah SWT (Mohd Syaubari Othman et. al, 2022).

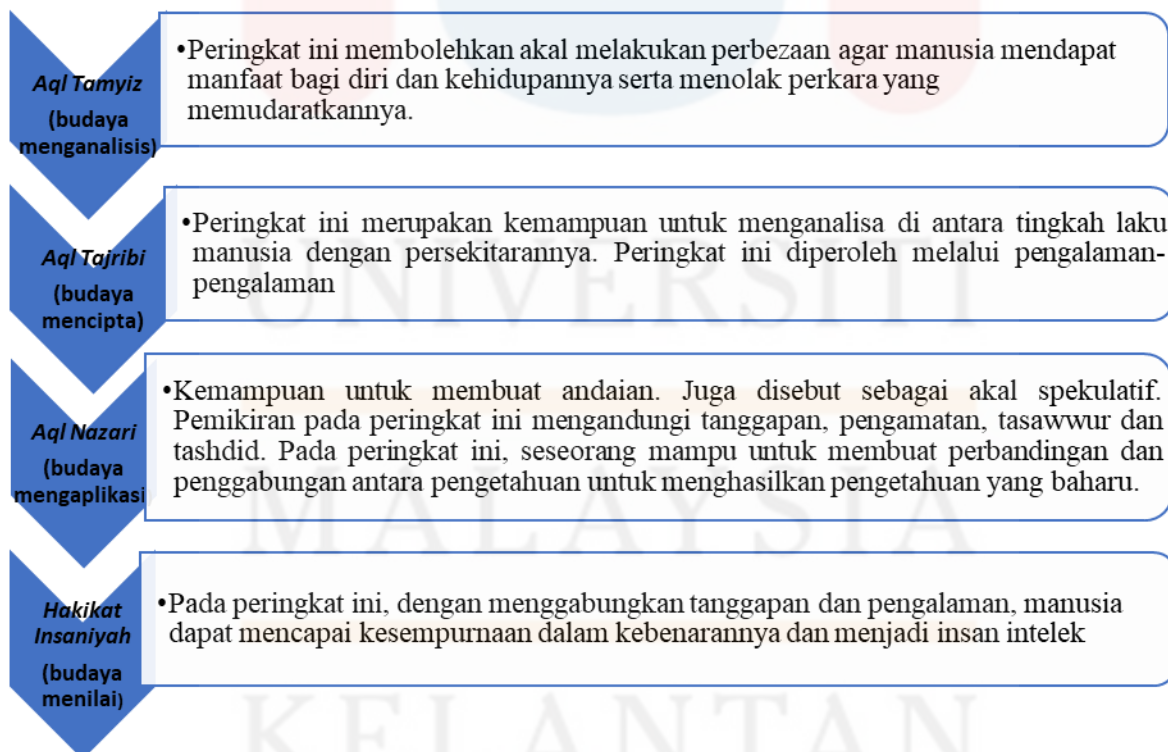

Rajah 1.1: Teori Budaya Inovasi Pengajaran. Adaptasi daripada Muqaddimah Ibnu Khaldun (2002).

KESIMPULAN

Dalam konteks pendidikan, inovasi pengajaran amat diperlukan supaya guru sentiasa mencuba dan mencari kaedah pengajaran dan pendekatan baharu yang lebih berkesan. Perubahan persekitaran dunia yang sentiasa berubah dengan cepat menuntut komitmen yang tinggi oleh semua guru Pendidikan Islam. Amalan pengajaran yang digunakan oleh guru berbeza-beza bergantung pada kreativiti yang dimiliki dan kemampuan masing-masing menyampaikan pengajarannya (Roslinda Murad et; al, 2018). Guru yang kreatif dan inovatif akan cuba menjana idea menghasilkan dan mengaplikasikan inovasi dalam pengajaran mereka bagi memastikan proses pengajaran dapat memenuhi matlamat (Hamir Hamzah & Mohamad Hilmi, 2021). Justeru, setiap guru perlu merangka inovasi dalam pengajaran dalam melaksanakan proses pengajaran bagi membudayakan inovasi di kalangan guru Pendidikan Islam.

RUJUKAN

- Abdul Said Ambotang & Norhayati Bayong (2021). *Hubungan Antara Beban Tugas Dan Tekanan Kerja dengan Komitmen Guru Sekolah Rendah*. Jurnal Pendidikan Bitara Upsi Vol.11, 2018 / Issn 1394-7176 (11-21)
- Azrina sobian (2011). *Islam, Kreativiti & Inovasi*. IKIM, Attin Press Sdn. Bhd.
- Chua Yan Piaw (2014). *Kecerdasan Pelbagai Pemimpin Pendidikan (Teori, Amalan dan Penyelidikan)*, Penerbit Universiti Malaya, Kuala Lumpur.
- Franz Rosenthal (2005). *Ibnu Khaldun The Muqaddimah, An Intoduction To History*. Bollingen series, Princeton.
- Hamir Hamzah, Jessica Dora Henry & Zamri Mahamod (2021). *Penerapan Amalan Kreativiti, Pemikiran Kritis, Kolaborasi dan Komunikasi (4C) Pembelajaran Abad Ke-21 Dalam Kalangan Guru Bahasa Melayu*. Jurnal Dunia Pendidikan Vol. 3, No. 1, 239-248.
- Ibnu Khaldun, (1993) *Muqaddimah*. Dewan Bahasa dan Pustaka. Kuala Lumpur
- Ibnu Khaldun, (2002) *Muqaddimah* Dewan Bahasa Dan Pustaka, Kuala Lumpur
- Jessica Dora Henry & Zamri Mahamod (2021), *Penerapan Amalan Kreativiti, Pemikiran Kritis, Kolaborasi dan Komunikasi (4C) Pembelajaran Abad Ke-21 dalam Kalangan Guru Bahasa Melayu*, Jurnal Dunia Pendidikan Vol. 3, No.1, 239-248, 2021
- Kamus Dewan Edisi ke-Empat (2007). Dewan Bahasa Dan Pustaka, Kuala Lumpur.
- Kementerian Pendidikan Malaysia (2014). *Pelan Pembangunan Profesionalisme Berterusan (Guru Dan Pemimpin Sekolah)*. Putrajaya: Bahagian Pendidikan Guru.
- Kementerian Pendidikan Malaysia (2018). *Konvensyen Kebangsaan Program Transformasi Sekolah (TS25)*
- Mohammad Abdullah Enan (2014), *IbnuKhaldun: Riwayat Hidup & Karyanya*, ITBM, Kuala Lumpur.
- Mohamad Rashid Mohamad Noh, Suhaimi Sabran, Nur Aileen Lau Abdullah @ Eileen Lau Ai Ting & Omar Firdaus Mohd Said, *Kompetensi Amalan Kepimpinan Guru Besar bagi Program Transformasi Sekolah 2025 (TS25) Kementerian Pendidikan Malaysia di Sekolah Rendah Daerah Sabak Bernam*, Jurnal Sains Sukan dan Pendidikan Jasmani Vol 10, No 1, 2021 (65-72).
- Mohamad Zarkhuan Zainol (2020), *Pengaruh Latihan Guru Pendidikan Islam Terhadap Kualiti Modal Insan Dalam Kalangan Guru Novis*, Tesis PhD, Universiti Pendidikan Sultan Idris.
- Mohd Fahmi B Mohd Yusof, (2016), *Kesediaan Guru Sekolah Menengah Mengamalkan Pengajaran Abad ke-21*. Fakulti Pendidikan Teknikal Dan Vokasional, Universiti Tun Hussein Onn Malaysia.

- Mohd Syaubari Othman (2019). *Pelaksanaan Komposisi Pengajaran Guru Pendidikan Islam Yang Mengintegrasikan Kemahiran Berfikir Aras Tinggi (KBAT) Dalam Bidang Akidah Sekolah Rendah Di Malaysia*, Tesis Ijazah Doktor Falsafah, Universiti Sultan Idris.
- Mohd Syaubari Othman & Ahmad Yunus Bin Kassim (2021). *Keberkesanan Amalan Pengajaran Guru Pendidikan Islam Menerusi Kemahiran Berfikir Aras Tinggi (KBAT) Di Dalam Mata Pelajaran Pendidikan Islam Sekolah Rendah Negeri Perak*. International Journal of Islamic and Civilizational Studies. vol. 8, no.1 pp. 75-86.
- Mohd Syaubari Othman & Ahmad Yunus Bin Kassim, Abu Bakar Yusof, Hasrul Bin Hosshan, Mohd Afifi Bahurudin Setambah, Mazarul Hassan Mohamad Hanapi, Kama Shafeei & Mohd Ridhuan Mohd Jamil (2022). *Penyebatian Konsep Penyelesaian Masalah Berasaskan Kemahiran Berfikir Aras Tinggi (Kbat) Dalam Amalan Pengajaran Guru Pendidikan Islam*, Jurnal Kepimpinan Pendidikan, Julai 2022, Bil. 9, Isu 3
- Mohd Hasril Amiruddin & Alias Masek (2014). *Inovasi dalam Teknologi Pendidikan – Isu dan Cabaran*. Penerbit UTHM.
- Mohd Zaidi Ismail (2018). *Kreativiti & Imajinasi Dalam Psikologi Islami Pengamatan Al-Ghazali, Al-Baghdadi dan Al-Razi*, penerbit IKIM, Percetakan Asia Print Sdn. Bhd.
- Moh. Pribadi (2017). *Tahapan Pemikiran Masyarakat Dalam Pandangan Ibn Khaldun*, Sosiologi Reflektif, Volume 11, No. 2, April 2017.
- Mohd Zahirwan Halim Zainal Abidin, Pisol Maidin, Muhammad Yusri Yusof, Paiz Hassan, Hamdi Rahman Mohd Yaacob, Abd Munir Mohd Noh & Muhammad Imran Abd Razak (2017). *Pandangan Ibnu Khaldun Berkaitan Kaedah Pendidikan Dalam Kitab Al-Muqaddimah*, Akademi Pengajian Islam Kontemporari (ACIS), UITM Perak.
- Muhsin Mahdi (2014), *Falsafah Sejarah Ibnu Khaldun. Kajian Tentang Dasar Falsafah Ilmu Budaya*, ITBM, Kuala Lumpur.
- Muliyati Timbang & Abdul Said Ambotang (2020), *Pengaruh Inovasi Teknologi, Peranan Pentadbir dan Kediaan Guru Terhadap Profesionalisme Keguruan Sekolah Luar Bandar di Sabah*, Malaysian Journal of Social Sciences and Humanities, Volume 5, Issue 2, (page 96 - 106).
- Nazariyah Bt Sani (2014). *Inovasi Guru Linus Membantu Murid Menguasai Literasi. Persidangan Kebangsaan Kurikulum Dan Teknologi Pengajaran*, Universiti Malaya.
- Norazilawati Abdullah (2020) *Trend Dan Isu Pendidikan Abad Ke-21*, Penerbit UPSI.
- Nur Jannah Keman, Norasmah Othman & Jamalulail Abd. Wahab (2021). *Hubungan Kepimpinan Transformasional Pentadbir Sekolah Dengan Komitmen Kerja Guru Di Sekolah Rendah*. Jurnal Penyelidikan Dedikasi Jilid 19 (Bil.1).
- Roslinda Murad, Supyan Hussin, Syazreen Zakaria & Md Hanafizah Ya'acob (2018), *Inovasi Dalam Pendidikan Meningkatkan Perkembangan Budaya*, International Conference ASBAM 2018.
- Saedah Siraj, Zainun Ishak & Tunku Mohani Tunku Mokhtar (1996), *Motivasi Dalam Pendidikan*, Utusan Publications, Kuala Lumpur.
- Wahbah az-Zuhaili. (1997). *At-Tafsir al-Munir fil Akidah wasy Syari'ah Wal Manhaj*. Damsyik: Darul Fikr al-Mu'asoroh
- Wan Ali Akbar Wan Abdullah, Khadijah Abdul Razak, & Mohd Isa Hamzah. (2020b). *Pengurusan Masa Guru Inovatif Pendidikan Islam*. Online Journal of Islamic Education, 8(2), 33–39.
- Wan Ali Akbar Wan Abdullah, Khadijah Abdul Razak, & Mohd Isa Hamzah & Nursaffra. (2020a). *Pengetahuan Untuk Menghasilkan Inovasi Pengajaran Dalam Kalangan Guru Inovatif Pendidikan Islam*. Online Journal of Islamic Education, 8(2), 33–39.
- Wan Ali Akbar Wan Abdullah, Khadijah Abdul Razak, & Mohd Isa Hamzah & Nursaffra. (2020b). *Peranan Pentadbir Sebagai Pencetus Penghasilan Inovasi dalam Kalangan*

Guru Inovatif Pendidikan Islam. Journal of Quran Sunnah Education & Special Needs, Vol.4(1) June 2020.

Wan Mariana Wan Mohamad, Kamarul Shukri Mat Teh & Wan Ali Akbar Wan Abdullah (2021). *Elemen Interaksi Dalam Diri Dan Sesama Manusia Berasaskan Al-Quran Dalam Pembelajaran Abad Ke-21 Pendidikan Islam*. Sains Humanika 13:2 (2021), 7-14.

Zaidi Saleh, Jamilah Ahmad & Yahya Buntat (2021). *Proses Awal Pembinaan Instrumen Pemikiran Kreatif Bagi Guru Besar*, Jurnal Dunia Pendidikan Vol. 3, No. 2, 210-224.



Pemikiran dan Perjuangan Ebit Irawan bin Ibrahim Lew dalam Dakwah Golongan Asnaf di Malaysia

Kartina Sari Abd Karim²³
Pusat Pengajian Ilmu Kemanusiaan
Universiti Sains Malaysia
kartinasarikarim@student.usm.my

Muhammad Azizan Sabjan²⁴
Pusat Pengajian Ilmu Kemanusiaan
Universiti Sains Malaysia
mazizan@usm.my

ABSTRACT

The asnaf group is a minority group that has a certain share in zakat as prescribed. However, those of poor and needy is now increasing following the Movement Control Order (MCO) which had to be enforced to curb the spread of the COVID19 disease. Therefore, this study was conducted to analyze the thoughts and struggles of Ebit Irawan bin Ibrahim Lew in the preaching of the asnaf group, especially in Malaysia. The findings obtained through the collection of library data carried out are identified and researched. The findings of the study show that more such aid is needed in every state in our country after various economic sectors had to be closed before in order to restore their survival holistically. Ebit Lew's stature and authority in defending the plight of the asnaf should be emulated at various levels of preaching and humanitarian missions to eradicate poverty and empower the economy of the regional community in Malaysia in a targeted and comprehensive manner.

Keywords: *asnaf group; zakat; preaching; Ebit Lew; humanitarian mission*

ABSTRAK

Golongan asnaf merupakan kelompok minoriti yang mempunyai bahagian tertentu dalam zakat seperti yang telah disyariatkan. Namun, golongan asnaf yang bertaraf fakir dan miskin kini semakin meningkat berikutan Perintah Kawalan Pergerakan (PKP) yang terpaksa dikuatkuasakan bagi mengekang penularan wabak COVID19. Justeru, kajian ini dijalankan bagi menganalisis pemikiran dan perjuangan Ebit Irawan bin Ibrahim Lew dalam dakwah golongan asnaf khususnya di Malaysia. Hasil dapatan yang diperoleh melalui pengumpulan data kepustakaan yang dijalankan dikenal pasti dan diselidiki. Dapatan kajian menunjukkan bahawa lebih banyak bantuan seumpamanya diperlukan di setiap negeri di negara kita setelah pelbagai sektor ekonomi terpaksa ditutup sebelum ini bagi memulihkan kembali kelangsungan hidup mereka secara holistik. Ketokohan dan kewibawaan Ebit Lew membela nasib golongan asnaf wajar dicontohi di pelbagai peringkat dakwah dan misi kemanusiaan bagi membasmi kemiskinan dan memperkasakan ekonomi ummah serantau di Malaysia secara bersasar dan menyeluruh.

Kata kunci: *golongan asnaf; zakat; dakwah; Ebit Lew; misi kemanusiaan*

²³ Beliau merupakan calon Sarjana Sastera (Tamadun Islam) di Pusat Pengajian Ilmu Kemanusiaan, Universiti Sains Malaysia.

²⁴ Prof. Madya Dr. Muhammad Azizan Sabjan ialah pensyarah di Bahagian Falsafah dan Tamadun, Pusat Pengajian Ilmu Kemanusiaan, Universiti Sains Malaysia.

PENDAHULUAN

Golongan asnaf dikenali sebagai sekumpulan kecil dalam kalangan muslimin dan muslimat yang layak menerima zakat seperti yang termaktub dalam surah Al-Taubah (9) ayat 60:

إِنَّمَا الصَّدَقَتُ لِلْفُقَرَاءِ وَالْمَسْكِينِ وَالْعَمِلِينَ عَلَيْهَا وَالْمَوْلَّاتِ فُلُوهُنَّ فِي الرِّقَابِ
وَالْغَرَمِينَ وَفِي سَبِيلِ اللَّهِ وَابْنِ السَّبِيلِ فَرِيضَةً مِّنَ اللَّهِ وَاللَّهُ عَلِيمٌ حَكِيمٌ

“Sesungguhnya sedekah-sedekah (zakat) itu hanyalah untuk orang-orang fakir, dan orang-orang miskin, dan amil-amil, dan orang-orang muallaf yang dilunakkan hatinya, dan untuk hamba-hamba yang hendak memerdekakan dirinya, dan orang-orang yang berhutang, dan untuk (dibelanjakan pada) jalan Allah, dan orang-orang musafir (yang terputus) dalam perjalanan. (Ketetapan hukum yang demikian itu ialah) sebagai satu ketetapan (yang datanginya) daripada Allah. Dan (ingatlah) Allah Maha Mengetahui, lagi Maha Bijaksana”.

Daripada ayat di atas, golongan asnaf terdiri daripada golongan fakir, orang-orang miskin, amil-amil, golongan saudara baru, riqab, gharimin, golongan fisabilillah dan orang-orang yang bermusafir yang terputus bekalannya. Zakat yang diberikan kepada golongan asnaf bukanlah suatu bentuk bantuan ihsan semata-mata malah membawa pengertian yang luas dan tersendiri. Hal ini demikian kerana zakat dapat menyucikan harta dan menyingkirkan sifat-sifat kedekut dan bakhil bagi si pemberi sementara bagi penerima zakat pula dapat menghalang mereka daripada berprasangka buruk atau berhasad dengki terhadap orang kaya.²⁵ Selain daripada sumber agihan zakat, golongan asnaf turut dibantu melalui pemberian sedekah, hadiah dan wakaf sebagai suatu bentuk pengagihan semula dalam sistem ekonomi Islam.

Walaupun zakat telah diperuntukkan kepada kelapan-lapan golongan asnaf di atas, namun kelompok fakir dan miskin secara jelasnya menerima agihan zakat yang lebih berbanding kumpulan asnaf yang lain. Senario ini menunjukkan bahawa masalah kemiskinan masih berakar umbi dalam masyarakat kita walaupun pelbagai inisiatif dan bantuan rakyat telah disediakan oleh pihak kerajaan mahupun swasta dari semasa ke semasa. Masalah kekurangan pendapatan untuk membeli keperluan asas, taraf pendidikan yang rendah, kesempitan harta benda, masalah kesihatan, sumber makanan dan pakaian yang terhad, tempat tinggal yang tidak selesa dan tiada pekerjaan yang tetap merupakan isu yang perlu dibendung dengan sewajarnya.²⁶ Konsep kemiskinan sangat berkait dengan golongan asnaf yang rata-ratanya tidak mampu memenuhi keperluan asas apatah lagi menikmati kemudahan sosial walaupun pada tahap yang minimum.²⁷ Krisis sosioekonomi ini jika tidak dikawal dan dibendung akan membantutkan peluang pendidikan anak-anak dan memungkinkan kemiskinan diwarisi secara kekal.

Salah seorang tokoh pendakwah bebas yang terkenal dengan misi bantuan kemanusiaan terhadap golongan asnaf di Malaysia ialah Ebit Irawan bin Ibrahim Lew. Beliau merupakan seorang aktivis masyarakat yang sangat berpengaruh di negara kita sehingga mencetuskan suatu fenomena baharu dalam dunia dakwah Islam Perjuangan Ebit Lew berjaya diperluaskan dan dimanfaatkan kepada pelbagai golongan sasaran tanpa mengira bangsa dan agama.

²⁵ Fuadah Johari. (2004). *Keberkesanan Zakat dalam Mengatasi Masalah Kemiskinan di Negeri Melaka*. (Tesis Sarjana). Universiti Malaya, Kuala Lumpur.

²⁶ Norzita Jamil dan Siti Halijah Che Mat. (2014). Realiti Kemiskinan: Satu Kajian Teoritik. *Jurnal Ekonomi Malaysia*. Pusat Pengajian Ekonomi dan Kewangan, UUM.

²⁷ Nurazynie Herman. (2019). *Kemiskinan Multi Dimensi: Pengkategorian Kemiskinan Golongan B40 Di Bandar Bayan Baru, Pulau Pinang*. (Tesis Sarjana). Universiti Sains Malaysia, Gelugor.

Gagasan pemikiran beliau yang unik dan inovatif telah mengubah kebiasaan masyarakat kita yang dahulunya pasif kepada suatu pembentukan komuniti baru yang progresif. Sumbangan beliau terhadap fakir dan miskin dapat diterjemahkan apabila mereka dapat membaiki taraf hidup sendiri malah menyumbang pula kepada pembangunan ekonomi ummah dan berbakti kepada negara tercinta. Semangat juang Ebit Lew kini menjurus kepada kebangkitan era dakwah yang berpotensi untuk terus dibangunkan apabila golongan asnaf mendapat pembelaan yang sewajarnya.

PENGALAMAN HIDUP EBIT LEW

Ebit Irawan bin Ibrahim Lew @ Lew Yun Pau dilahirkan pada 21 Disember 1984 dan berasal dari Muadzam Shah, Pahang Darul Makmur. Beliau merupakan anak kesepuluh daripada dua belas orang adik-beradik. Ayah beliau, Ibrahim Lew yang berketurunan Cina menganut Islam ketika mengahwini ibu, Syamsinar Binti Hakim yang berbangsa Melayu dari Jakarta, Indonesia. Enam orang adik-beradik beliau daripada perkahwinan ayahnya yang terdahulu masih beragama Buddha.²⁸ Beliau dibesarkan dalam keluarga yang senang di mana ayah beliau merupakan seorang pengusaha ladang. Namun, setelah perniagaan ayah beliau merosot, mereka sekeluarga telah hilang mata pencarian. Ibu beliau terpaksa bekerja sebagai seorang tukang masak di restoran bagi menampung keperluan mereka sekeluarga. Kehidupan Ebit Lew di kampus juga sukar malah menghadapi masalah dalam membiayai kos pengajian. Di sebalik semua ujian tersebut, ibu beliau tidak putus-putus memberi perangsang kepada beliau untuk tekun belajar tanpa menghiraukan perkara-perkara lain.²⁹

Ebit Lew mempunyai pengalaman yang lebih mencabar setelah memasuki alam pekerjaan. Beliau menjalani kehidupan dengan serba kekurangan. Beliau pernah menjual jering dan kerdas di pasar malam dan bekerja di kilang dengan pendapatan kasar sebanyak beberapa ratus ringgit sahaja. Penampilan beliau yang selekeh pada waktu itu seperti berkastut buruk dan tidak berstoking menyebabkan beliau sukar mendapatkan pekerjaan. Beliau juga pernah tidur di masjid dan di atas guni serta solat beralaskan kotak.³⁰ Walaupun berat ujian hidup yang dijalani, beliau tidak pernah lupa untuk bersedekah. Sepinggian nasi yang diperoleh tetap dikongsikan bersama orang lain. Duit gaji berjumlah RM800 semuanya diberikan buat ibu tercinta sebagai tanda kasih dan sayang seorang anak. Begitulah cara beliau menunjukkan erti kesyukuran yang sebenar dengan bersedekah di kala susah mahupun senang.

Yakin dengan janji Allah, perubahan demi perubahan berlaku dalam hidup beliau. Pengalaman beliau bekerja di Excel Training & Consultancy³¹ selama 4 tahun sebagai perunding latihan dan penceramah motivasi menjadi titik permulaan kepada kejayaan beliau. Pada tahun 2010, beliau akhirnya berjaya menubuhkan syarikat rundingannya sendiri iaitu Transform Training & Consultancy³². Rezeki yang tidak putus-putus dimanfaatkan dan dikongsikan bersama golongan yang amat memerlukan di seluruh negara tanpa mengira latar

²⁸ Ku Mengharapkan Pengampunan Mu Ya Allah. (2012, Disember 2). *IKIM.FM Y.BHG. USTAZ EBIT LEW-001* [Video]. YouTube. <https://youtu.be/39EYGVXF9h0>

²⁹ Ebit Lew. (2018). *11 Amalan Memiliki Kekayaan*. Bangi, Selangor: Transform Publication.

³⁰ Ebit Lew. (2021). *Saya Pernah Tidur di Masjid, Pernah Tidur Atas Guni. Duit Gaji Bagi Dekat Emak Semua*. Diakses 24 Februari 2021, <https://www.facebook.com/ebitlew>

³¹ Excel Training & Consultancy telah diasaskan oleh Dato' Dr. Haji Mohd. Fadzilah Kamsah pada tahun 2011. Seorang pakar motivasi yang menyediakan pelbagai latihan, kursus dan rundingan untuk keluarga, golongan korporat dan pembangunan sosial. Lihat, <http://dmfkinspirations.com/>

³² Transform Training & Consultancy bermatlamat menambah baik modal insan agar mempunyai daya juang yang tinggi. Antara program yang dianjurkan ialah Keluarga Sunnah, Prokids Tour dan Program Pekerja. Lihat, <https://transformjiwa.com/profil-syarikat/>

belakang agama dan budaya. Bagi menghargai segala usaha beliau membantu insan yang terjejas sepanjang tempoh Perintah Kawalan Pergerakan (PKP)³³, tanggal 15 Ogos 2020 menyaksikan Kementerian Belia dan Sukan (KBS) telah berbesar hati menyampaikan Anugerah Khas Hari Belia Negara 2020 kepada beliau. Ebit Lew juga mendapat undian tertinggi dalam Anugerah Meletop ERA (AME) yang melayakkan beliau untuk menerima Anugerah Wira AME³⁴ pada 20 Disember 2020.

PENDEKATAN PERJUANGAN DAKWAH EBIT LEW TERHADAP GOLONGAN ASNAF

Pendekatan dakwah yang dipilih tidak dapat lari daripada mempertimbangkan kemaslahatan golongan sasaran serta suasana persekitaran yang menyelubungi hidup mereka. Ebit Lew menggunakan pendekatan kebudayaan dalam menjalankan dakwah terhadap golongan asnaf. Pendekatan kebudayaan ini amat sesuai diamalkan di negara kita yang terdiri daripada pelbagai ras, keturunan, bangsa dan agama. Amalan kebudayaan yang dipraktikkan adalah bergantung kepada kepercayaan, norma dan adat resam sesuatu suku kaum yang boleh berubah dan sentiasa berkembang. Skop kebudayaan bagi rakyat Malaysia adalah begitu luas sehingga membolehkan penyebaran dakwah dilaksanakan melalui mana-mana tradisi seperti perayaan, perkahwinan dan kesenian. Pendekatan kebudayaan dalam dakwah didapati lebih berkesan kerana jurang antara pendakwah dengan golongan yang memerlukan dapat dikurangkan dan sekaligus mengelakkan rasa rendah diri yang menghalang mereka daripada didakwahkan.

Ebit Lew amat konsisten dalam menjalankan ziarah dan lawatan ke rumah-rumah fakir dan miskin di seluruh negara. Beliau mempunyai inisiatif sendiri untuk menjejaki rumah-rumah usang dan dhaif di kawasan-kawasan pedalaman serta cepat memberikan respon kepada mana-mana individu yang memberikan maklumat tentang keluarga yang perlu dibantu. Beliau suka bertanya khabar dan cuba menyelami kesukaran hidup yang dilalui oleh golongan yang kurang bernasib baik dengan bersandarkan kepada pengalaman hidup beliau sendiri. Sifat empati yang dimiliki menyebabkan beliau lebih berupaya untuk merasai keperitan hidup orang lain dengan meletakkan diri beliau di tempat mereka. Beliau sentiasa melihat kebaikan di sebalik bebanan hidup yang ditanggung oleh orang-orang miskin, anak-anak yatim, golongan orang kelainan upaya (OKU), para ibu tunggal dan warga emas.

Sambutan perayaan yang diraikan oleh masyarakat berbilang kaum dapat mencerminkan budaya toleransi dan perpaduan di negara kita. Begitulah kehadiran Ebit Lew di perkampungan Cina di Ulu Yam, Selangor menjelang sambutan Tahun Baru Cina.³⁵ Warga tua yang ditemui dianggap seperti ibu dan bapa sendiri. Persamaan darah keturunan mengeratkan persaudaraan sesama mereka walaupun berbeza pegangan agama. Masyarakat Cina yang dijumpai di Sungai Sayong, Renggam Johor pula dirasai seperti ahli keluarga sendiri.³⁶ Beliau menyelami masalah yang dihadapi oleh para penduduk di sana serta membuka ruang kepada penyelesaian. Sami-sami di Tokong Wat Nikrodharam, Alor Setar turut diziarahi

³³ Astro Awani. (2020, Ogos 15). *Hari Belia Negara 2020: Dekad Ini Dekad Anda* [Video]. YouTube. <https://www.youtube.com/watch?v=XHkeGTauN6w>

³⁴ MyBuzz. (2020, Disember 20). *AME2020 Ebit Lew – Anugerah WIRA* [Video]. YouTube. <https://youtu.be/SJPy6K-kwi4>

³⁵ Ebit Lew Supporters [t.me/TeamEbitLew]. (2021, Februari 8). Gong Xi Fa Cai. Happy CNY. Ziarah di Ulu Yam. Hadaikan basikal baru, angpow, barang dapur Elewsmart dan limau. Telegram. <https://telegram.org>

³⁶ Ebit Lew Supporters [t.me/TeamEbitLew]. (2021, Februari 12). Gembira sangat dapat adakan FoodBank kampung Cina di Sungai Sayong, Renggam Johor. Telegram. <https://telegram.org>

bagi berkongsi kasih sayang.³⁷ Usaha beliau mencari titik kesefahaman dengan tokoh-tokoh agama lain amat dihargai di sebalik segala perbezaan identiti dan kepercayaan.

Selain itu, kehadiran Ebit Lew dalam memperkasakan pendidikan anak-anak asnaf menjadi pelengkap kepada segala bentuk bantuan dan sumbangan sedia ada. Rata-rata bantuan yang ditawarkan oleh badan-badan kerajaan dan swasta selama ini menggunakan kaedah konvensional yang menuntut agar permohonan dilakukan sendiri oleh pemohon. Taraf kelayakan mereka akan dinilai sebelum bantuan yang diperuntukkan disalurkan. Kesannya, mereka terpaksa menunggu dalam suatu tempoh tertentu sebelum urusan pendidikan anak-anak mereka dapat disempurnakan. Berbeza dengan pendekatan Ebit Lew yang mengambil inisiatif sendiri menjejaki keluarga-keluarga yang kurang bernasib baik untuk membiayai pendidikan anak-anak mereka secara percuma dan serta-merta. Pendekatan dakwah dalam pendidikan yang diterajui oleh beliau amat mudah dan menyenangkan semua pihak yang menerima tanpa perlu melalui apa-apa prosedur atau proses yang rumit.

Di Kuantan, anak-anak asnaf yang ditemui dilayan seperti anak-anak beliau sendiri.³⁸ Beliau menanamkan cita-cita yang tinggi dalam diri mereka agar tidak berputus asa dalam pelajaran walaupun dihipit dengan kemiskinan dan kesukaran hidup. Beliau menawarkan pengajian di madrasah agar mereka berjaya menghafal Al-Quran dan menjadi imam besar suatu hari nanti. Kesenambungan daripada itu, ibu bapa mereka tidak perlu berasa bimbang mengenai perbelanjaan persekolahan anak-anak mereka. Perhatian yang sewajarnya ditumpukan kepada proses pembelajaran ke arah kecemerlangan akademik yang lebih menjamin masa depan. Perkara yang sama turut dilakukan di Klang dan Johor Bahru.³⁹ Beliau berbesar hati membawa anak-anak yatim dan kurang bernasib baik membeli-belah barang-barang keperluan termasuklah pakaian persekolahan seperti jubah dan serban. Seterusnya, urusan penghantaran dan kemasukan ke madrasah terpilih diselesaikan pada hari yang sama.

Bagi memastikan agar bantuan kepada para pelajar yang memerlukan dapat diagihkan dengan mudah dan pantas di seluruh negara, Ebit Lew mempromosikan pelbagai jenis kemudahan pendidikan di laman-laman sosial miliknya. Beliau mengemukakan pemberian sebanyak 100 tab untuk pembelajaran secara atas talian yang menjadi suatu keperluan sepanjang PKP dikuatkuasakan⁴⁰. Selain itu, 1000 pasang cermin mata berjumlah RM 200 ribu ditawarkan kepada murid-murid yang kurang berkemampuan daripada senarai sekolah-sekolah yang terpilih.⁴¹ Permohonan boleh dilakukan melalui pihak sekolah dengan menghubungi talian yang diberikan agar penerima yang benar-benar layak dapat diberikan keutamaan dan disenarai pendekkan. Apabila segala tuntutan yang diperlukan oleh seseorang pelajar berjaya ditunaikan, maka peluang pendidikan anak-anak fakir, miskin dan yatim dapat disempurnakan ke arah kecemerlangan intelektual yang mencorakkan masa hadapan.

³⁷ Ebit Lew Supporters [t.me/TeamEbitLew]. (2021, Februari 17). Saya melawat ke Tokong Wat

Nikrodharam di Alor Setar. Bawa sedikit angpow dan berkongsi kasih sayang. Telegram. <https://telegram.org>

³⁸ Ebit Lew Supporters [t.me/TeamEbitLew]. (2020, September 30). Terharu dapat hantar anak ini masuk sekolah. Alhamdulillah syukur. Tak sampai 2 jam dah dapat masuk sekolah baru. Telegram. <https://telegram.org>

³⁹ Ebit Lew Supporters [t.me/TeamEbitLew]. (2020, Oktober 16). Saya terus kata siapa nak masuk madrasah. Sekolah agama. Asrama. Nanti ustaz bayarkan yuran semua. Adik keluar dari sini. Telegram. <https://telegram.org>

⁴⁰ Ebit Lew Supporters [t.me/TeamEbitLew]. (2021, Januari 21). Pohon doakan yer. Baru beli biji 100 Tab untuk dihadiahkan pada pelajar yang memerlukan untuk kelas online. Telegram. <https://telegram.org>

⁴¹ Ebit Lew Supporters [t.me/TeamEbitLew]. (2021, Mac 1). Saya nak hadiahkan 1000 cermin mata berjumlah RM200,000 untuk pelajar yang memerlukan dari seluruh Malaysia. Telegram. <https://telegram.org>

Ebit Lew sangat menonjol dengan pendekatan psikologi yang digunakan dalam memperjuangkan nasib golongan asnaf termasuk masyarakat bukan Islam yang hidup dalam serba kekurangan. Bertepatan dengan maksud psikologi yang merujuk kepada kajian secara saintifik mengenai perlakuan dan proses-proses minda, beliau tampil dengan pendekatan psikologi dalam kerangka dakwah yang diusahakan. Menurut Olusola Ayandele, psikologi berupaya merungkai dan menjelaskan tingkah laku manusia serta jangkauan yang dapat dikenal pasti dalam mengubah sikap kepada ciri-ciri manusiawi yang lebih baik.⁴² Terdapat pelbagai pendekatan psikologi seperti pendekatan behaviorisme, psikoanalitik, kognitivisme, humanistik dan biologi.⁴³ Dengan itu, Ebit Lew memanfaatkan segala kelebihan yang ada untuk membangunkan perspektif dalaman individu secara bersasar.

Melalui pendekatan behaviorisme, Ebit Lew banyak melakukan pemerhatian di kawasan-kawasan pedalaman, lorong-lorong gelap serta di tengah-tengah bandaraya. Penelitian yang dilakukan mendapati kebanyakan masalah sosial didorong oleh faktor persekitaran. Masalah kesempitan hidup yang dilalui ialah sejenis rangsangan yang akan mencetuskan suatu tindak balas yang lain seperti keciciran dalam pelajaran, masalah tingkah laku dan jenayah. Apabila sesuatu keadaan yang mempengaruhi manusia berjaya dikawal maka, tindak balas dengan perlakuan tertentu dapat diperhatikan.⁴⁴ Oleh itu, Ebit Lew menyediakan suatu bentuk alternatif yang lain bagi menggantikan stimulus sedia ada kepada mereka yang terkesan dengan pemberian yang bersesuaian dengan masalah yang dihadapi. Sumbangan yang disalurkan akan menimbulkan suatu bentuk penerimaan dalam kalangan asnaf untuk berubah ke arah pembaharuan sikap yang lebih baik.

Pendekatan psikoanalitik pula menjadi kesinambungan kepada pendekatan behaviorisme di mana tahun-tahun terawal kelahiran merupakan tempoh kritikal kepada pembentukan psikologi seseorang. Menurut Sigmund Freud (1962), tingkah laku manusia ditentukan oleh corak pemikiran, perasaan kebimbangan dan pengharapan secara tidak sedar yang melatari perilaku normal atau tidak normal seseorang.⁴⁵ Kerisauan dan kekhuatiran hidup yang selama ini cukup sinonim dengan golongan asnaf akan kekal sepanjang hayat jika tidak dirawat. Seajar dengan itu, Ebit Lew berusaha menghentikan kitaran hidup sedemikian dengan memperuntukkan segala kelengkapan asas bagi keluarga-keluarga dhaif yang ditemui. Beliau berhasrat untuk menyediakan kehidupan yang lebih selesa bagi menyokong tumbesaran anak-anak mereka di samping meningkatkan taraf hidup untuk jangka masa panjang.

Selain itu, Ebit Lew menyedari akan kepentingan pendidikan formal bagi menyokong proses pemikiran anak-anak fakir, miskin dan yatim piatu. Berdasarkan pendekatan kognitif, apabila penekanan yang sepatutnya diberikan kepada proses-proses mental, maka seseorang individu boleh belajar dan mengaplikasikan ilmu pengetahuan.⁴⁶ Tindakan beliau menguruskan persekolahan anak-anak asnaf membolehkan mereka berfikir secara kritis dan kreatif, menganalisis, menaakul dan menyelesaikan masalah. Pengalaman semasa di alam persekolahan berpotensi untuk membimbing anak-anak asnaf menghadapi cabaran yang lebih besar di hari muka. Tanpa pengalaman hidup yang secukupnya, mereka akan terdedah kepada

⁴² Olusola Ayandele. (2016). *Basic Psychology*. Ibadan, Nigeria: Hope Publications Ltd.

⁴³ Saul McLeod. (2022). *Simply Psychology*. Diakses 27 Februari 2022, <https://www.simplypsychology.org/behaviorism.html>

⁴⁴ Andrew P. Johnson. (2014). *Education Psychology: Theories of Learning and Human Development*. Washington, DC: National Science Press.

²³ Eric Rucks. (2015). *Sigmund Freud's Theories of Personality*. Diakses 1 Mac 2022, <http://www.polsci.tu.ac.th/sigmund1.pdf>

⁴⁶ Clint Grider. (1993). *Foundations of Cognitive Theory: A Concise Review*. Diakses 1 Mac 2022, <https://files.eric.ed.gov/fulltext/ED372324.pdf>

pelbagai kesukaran ketika menginjak alam dewasa seperti melalui alam pekerjaan dan menguruskan kehidupan berumah tangga kelak.

Bantuan misi kemanusiaan yang dipelopori oleh Ebit Lew turut diperluaskan kepada mangsa-mangsa yang terlibat dengan banjir, kemalangan jalan raya dan kebakaran. Pendekatan humanistik dilihat amat bersesuaian untuk diaplikasikan apabila Hirarki Keperluan Maslow⁴⁷ seseorang menghadapi masalah. Ebit Lew sentiasa bertanya khabar dan cuba menyelami isi hati mereka berkenaan musibah yang melanda sama ada kehilangan nyawa, kekurangan harta benda dan lain-lain. Beliau menyedari bahawa setiap insan mempunyai potensi untuk dibangunkan di sebalik pelbagai ujian hidup yang dilalui. Dengan berbekalkan pengalaman beliau sebagai pakar runding di *Transform Training & Consultancy*, beliau sering memberikan galakan dan kata-kata semangat buat keluarga mangsa agar tabah menghadapi ketentuan Allah SWT. Program ziarah yang dilaksanakan turut dilengkapi dengan sumbangan peribadi sebagai suatu bentuk sokongan psikologi buat mereka.

FAKTOR PERJUANGAN DAKWAH EBIT LEW TERHADAP GOLONGAN ASNAF

Cita-cita Ebit Lew untuk menjadi manusia yang paling bermanfaat merupakan faktor pendorong agar beliau terus berdakwah memperjuangkan nasib golongan asnaf di negara kita. Segala kelebihan yang dimiliki digunakan sehabis baik untuk berbakti kepada segenap lapisan masyarakat yang memerlukan agar mereka juga tidak terkecuali untuk menerima dan menikmati kebaikan yang ingin disampaikan. Rasulullah SAW bersabda,

وَحَيْرُ النَّاسِ أَنْفَعُهُمْ لِلنَّاسِ

“Sebaik-baik manusia ialah yang paling bermanfaat bagi manusia yang lain.”
(Riwayat Ibn Hibban)

Berdasarkan hadith ini, kita amat digalakkan untuk sentiasa mendatangkan manfaat kepada orang lain dalam rangka menjadi manusia yang paling baik. Oleh sebab itulah, beliau sering dilihat konsisten dalam menyalurkan bantuan yang tidak hanya terhad kepada pemberian berbentuk fizikal semata-mata. Beliau turut berkorban masa, tenaga dan buah fikiran apabila beliau sendiri turun ke lapangan bagi menguruskan pengagihan bantuan.

Keterlibatan Ebit Lew dalam dakwah golongan asnaf merupakan salah satu amal mujahadah atau amal darjat⁴⁸ yang dilakukan bagi mendekatkan diri kepada Allah SWT dan Rasulullah SAW. Beliau yakin dengan memberikan manfaat kepada orang lain dapat menyucikan hati dan meraih makrifat terhadap Allah SWT di samping mengharap ganjaran pahala di sisi-Nya. Kesungguhan beliau membantu orang yang ditimpa kesulitan atau terjebak dengan sesuatu kemungkaran, secara tidak langsung telah menarik mereka kepada suasana hidup yang lebih baik dan diredhai-Nya. Menurut beliau, amal makruf dan nahi mungkar yang sentiasa ditegakkan di jalan dakwah akan menjadi asbab untuk turunnya rahmat dan kasih

⁴⁷ Hirarki Keperluan Maslow telah dibangunkan oleh Abraham Maslow berdasarkan teori yang menyatakan bahawa segala tindakan kita didorong oleh beberapa keperluan psikologi tertentu yang disusun atur dalam bentuk piramid. Keperluan yang paling asas menduduki bahagian paling bawah piramid sementara keperluan yang lebih rumit terletak di bahagian atas. Keperluan psikologi berbentuk makanan, minuman, pakaian dan tempat tinggal perlu ditunaikan terlebih dahulu sebelum mencapai tahap-tahap keperluan hidup yang lain seperti keperluan terhadap keselamatan, sosial, penghargaan dan hasrat diri. Lihat, <https://www.verywellmind.com/what-is-maslows-hierarchy-of-needs-4136760>

⁴⁸ Abdul Manam Mohamad Al-Merbawi. (2019). *Jalan Taqarrub Kepada Allah SWT*. Diakses 5 Jun 2022, <https://muftins.gov.my/2019/04/19/tazkiyat-al-nafs-jalan-taqarrub-kepada-allah-s-w-t/>

sayang Allah SWT.⁴⁹ Oleh hal yang demikian, kedudukan di sisi Allah SWT akan sentiasa dapat diperbaharui dan ditingkatkan apabila semakin banyak amal kebajikan dilakukan bagi memudahkan urusan orang lain.

Berbeza dengan aktivis-aktivis kemasyarakatan yang lain di negara kita, Ebit Lew sentiasa mengajak lebih ramai orang untuk membantu golongan yang kurang bernasib baik yang mungkin tidak disedari selama ini. Kecenderungan beliau berkongsi kejadian yang berlaku di sebalik tabir kerja-kerja khidmat masyarakat yang dijalankan di pelbagai rangkaian media sosial dan rakan penyiaran tanah air bertujuan untuk menarik pihak-pihak yang berminat untuk turut serta menyumbang. Dengan itu, bantuan yang sewajarnya dapat diperluaskan secara lebih menyeluruh bagi mencakupi semua penduduk yang memerlukan di setiap negeri di Malaysia. Contoh yang ditonjolkan oleh beliau telah membuka minda dan mengubah mentaliti masyarakat kita agar berani untuk tampil ke hadapan bagi menjayakan misi bantuan dan kemasyarakatan yang seumpama dengannya.

Ebit Lew juga beriltizam untuk menjadi suri tauladan dalam dakwah golongan asnaf di negara kita. Kehadiran beliau di tengah-tengah komuniti masyarakat adalah sebagai contoh yang sangat berpotensi untuk mendidik orang ramai tentang kepentingan hidup pada memberi. Bersesuaian dengan hadith daripada Abi Mas'ud radhiallahu'anhu bahawa Rasulullah SAW bersabda,

مَنْ دَلَّ عَلَى خَيْرٍ فَلَهُ مِثْلُ أَجْرِ فَاعِلِهِ

“Barang siapa yang menunjukkan sesuatu kebaikan maka dia memperoleh pahala sama seperti yang melakukannya.”

(Riwayat Muslim)

Begitu besarnya ganjaran yang disediakan kepada sesiapa yang menunjukkan suatu jalan kebajikan yakni persis sebanyak pahala orang yang mengikutinya tanpa dikurangi sedikitpun pahala mereka. Malahan, amalan kebaikan akan sentiasa tertulis secara berterusan selagi mana mereka yang mengikutinya mengerjakan amal soleh tersebut. Beliau menasaskan agar khidmat masyarakat yang dipelopori oleh beliau akan sentiasa diteruskan dan mempunyai kelangsungannya walaupun sesudah ketiadaan beliau.⁵⁰

Di samping Ebit Lew menyampaikan mesej-mesej dakwah dan tarbiyyah dalam setiap misi bantuan kemanusiaan yang dijalankan, beliau juga memikul tanggungjawab yang besar untuk menyebarkan kasih sayang sesama manusia. Berdasarkan perspektif dan sudut pandangan beliau, setiap ujian atau dugaan yang menimpa hanyalah mempunyai satu tujuan yakni agar kita semua semakin berkasih sayang. Beliau berusaha sedaya upaya untuk memahamkan masyarakat yang diulit dengan kesulitan hidup agar menerima sebarang musibah yang menimpa sebagai suatu bentuk rahmat dan kasih sayang daripada Allah SWT buat para hamba-Nya. Bahkan, Allah SWT telah memberikan jaminan-Nya berkenaan perkara ini dalam surah Al-Insyirah (94) ayat 5 dan 6:

فَإِنَّ مَعَ الْعُسْرِ يُسْرًا ﴿٥﴾ إِنَّ مَعَ الْعُسْرِ يُسْرًا ﴿٦﴾

⁴⁹ Huda Hussain. (2020). *Ustaz Kenapa Tolong Orang Begitu Begitu? Ada Yang Berkata Teruk, Tak Bagus, Tak Baik – Ustaz Ebit Lew*. Diakses 10 April 2022, <https://gempak.com/intrend/ustaz-kenapa-tolong-orang-begitu-begini-ada-yang-berkata-teruk-tak-bagus-tak-baik-ustaz-ebit-lew-45355>

⁵⁰ Fatin Farhana Ariffin. (2020). *Menunjuk-nunjuk Ada Sebab – Ustaz Ebit Lew*. Diakses 10 April 2022, <https://www.bharian.com.my/hiburan/selebriti/2020/12/761433/menunjuk-nunjuk-ada-sebab-ustaz-ebit-lew>

“Sesungguhnya, berserta dengan kesulitan adanya kemudahan.
Sesungguhnya berserta dengan kesulitan adanya kemudahan.”

Kehadiran figura yang sangat disenangi ramai ini ternyata amat dinantikan oleh masyarakat setempat kerana dengan kehadirannya sahaja sudah mampu mengukir senyuman di wajah mereka. Itulah faktor penguat bagi Ebit Lew untuk sentiasa berada di jalan dakwah bagi memberikan khidmat bakti kepada golongan asnaf di Malaysia termasuklah masyarakat bukan Melayu yang hidup dalam serba kekurangan. Beliau komited untuk menggembirakan saudaranya setiap kali beliau mengangkat kesusahan yang ditanggung oleh mereka yang diuji melalui pertolongan dan sumbangan yang disalurkan. Terdapat hadith yang diriwayatkan oleh Siti Aisyah rha bahawa Rasulullah SAW bersabda,

مَنْ أَدْحَلَ عَلَى أَهْلِ بَيْتٍ مِنَ الْمُسْلِمِينَ سُورًا لَمْ يَرْضَ لَهُ اللَّهُ ثَوَابًا دُونَ الْجَنَّةِ

“Sesiapa yang menggembirakan mana-mana saudara muslim, maka Allah tidak akan memberinya pahala tanpa diberikan juga syurga.”

(Riwayat Al-Tabarani)

Setiap rezeki yang dikongsikan berjaya mengikat hati-hati mereka seolah-olah telah terjalin hubungan kekeluargaan sejak sekian lamanya. Kasih sayang yang terjalin ini akhirnya akan membentuk perpaduan yang dapat memacu kekuatan ummah sejagat.

KESAN PERJUANGAN DAKWAH EBIT LEW TERHADAP GOLONGAN ASNAF

Kesan perjuangan Ebit Lew terhadap golongan asnaf di Malaysia dapat dibahagikan kepada kesan bantuan dari sudut fizikal, psikologi dan spiritual. Ekoran bantuan fizikal atau bantuan sara hidup yang disasarkan kepada golongan fakir dan miskin di negara kita telah dapat meningkatkan dan memperbaiki kualiti hidup mereka. Menyedari bantuan bukan tunai seperti pemberian modal bisnes dan alat perkakas adalah lebih bersifat produktif dan lebih menguntungkan untuk jangka masa panjang, sumbangan Ebit Lew tidak terhad kepada wang tunai semata-mata. Dengan itu, golongan asnaf dapat berdikari untuk mencari sumber pendapatan secara tekal agar mereka mampu keluar daripada belunggu kemiskinan. Jika sebelum ini mereka mengharapkan bantuan ihsan daripada orang ramai, kini mereka mampu berdiri di atas kudrat mereka sendiri dengan sekurang-kurangnya dapat mencukupkan barangan keperluan harian.

Menurut Burnel dan Galster (1992)⁵¹, kualiti hidup dapat diukur melalui sejauh mana seseorang mencapai tahap kepuasan dari aspek pemakanan, pembelajaran, kesihatan, kediaman dan estetika. Tidak dinafikan faktor pendidikan yang rendah sedikit sebanyak mempengaruhi kualiti hidup individu selain faktor jumlah pendapatan dan bilangan tanggungan (Hairunnizam Wahid et al, 2004)⁵². Manakala jumlah pendapatan pula amat berkait rapat dengan tahap kesihatan di mana penyakit kronik yang dihidapi turut membataskan keupayaan mereka untuk keluar bekerja. Oleh itu, Ebit Lew sedaya upaya menyeimbangkan kedua-dua aspek di atas dengan menghulurkan bantuan biasiswa dan membekalkan bantuan kesihatan seperti kerusi roda dan katil hospital kepada setiap keluarga yang memerlukan agar mereka dapat meneruskan kelangsungan hidup secara menyeluruh demi masa depan yang lebih terjamin.

⁵¹ Burnell, J.D dan Galster, G. (1992). Quality of Life and Urban Size: An Empirical Note. *Urban Studies* (29), 727-735.

⁵² Hairunnizam Wahid, Sanep Ahmad & Mohd Ali Mohd Noor. (2004). Kesan Bantuan Zakat Terhadap Kualiti Hidup: Kajian Kes Asnaf Fakir dan Miskin. *The Journal of Muamalat and Islamic Finance Research*, 155.

Pendekatan psikologi dakwah Ebit Lew banyak memberi dorongan kepada golongan asnaf dalam menangani cabaran dan kesulitan hidup dengan kekuatan emosi yang seterusnya dapat menjana perubahan tingkah laku atau sikap yang lebih idealistik. Penghijrahan dari sudut akhlak dan sahsiah menjadi sasaran terpenting dakwah bagi menyuburkan pembentukan sikap yang lebih dinamik. Oleh itu, masyarakat mukmin yang proaktif dapat direalisasikan yang berpotensi untuk memperbaharui nasib kehidupan mereka sekeluarga di samping menambah nilai di sisi agama. Menurut Nur Najwa Hanani Abd Rahman et. al (2019), psikologi dakwah bukan sekadar membahaskan perilaku dan sikap seseorang malah menyeru manusia agar menumpukan aspek-aspek kerohanian dengan kembali mengamalkan setiap ajaran Islam bagi memperoleh kesejahteraan hidup di dunia dan akhirat.⁵³

Ebit Lew dilihat kerap menzahirkan rasa simpati, empati dan belas kasihan terhadap fakir dan miskin yang ditemui. Kesukaran hidup yang pernah dilalui suatu ketika dahulu menyebabkan beliau berkongsi persamaan dengan golongan asnaf yang dibantu. Di sinilah terletaknya kekuatan beliau untuk memanfaatkan peluang berinteraksi dengan golongan yang kurang bernasib baik dengan menyampaikan nasihat yang dapat membangunkan jati diri mereka lebih-lebih lagi dari sudut emosi. Sesungguhnya, apabila tuntutan emosi seseorang berjaya direalisasikan maka emosinya akan lebih tenang dan bahagia kesan langsung daripada rangsangan dan galakan dari sudut emosi yang diberikan (Abd Aziz Mohd Zin, 1999).⁵⁴ Emosi yang stabil dan sejahtera akan memberi impak langsung kepada seluruh tindakan agar mempunyai kecenderungan yang tinggi menurut panduan Al-Quran dan hadith.

Kesan perjuangan Ebit Lew terhadap golongan asnaf juga dapat dianalisis dari sudut pembangunan spiritual memandangkan bentuk bantuan sebegini lebih besar impaknya malah lebih kekal untuk disuburkan dalam peribadi seseorang muslim. Di sebalik pelbagai mehnah dan ujian hidup yang datang silih berganti, beliau tetap mengajak kumpulan sasaran yang dibantu agar bersegera ke arah penyucian jiwa (*tazkiyyah al-nafs*). Hal ini demikian agar segala bentuk kebimbangan atau kegelisahan yang menyelubungi hidup mereka dapat dirawat dan seterusnya membawa jiwa mereka ke arah kedamaian yang hakiki. Jiwa akan kembali tenang apabila diri sentiasa mendekati diri kepada Allah SWT di samping meninggalkan segala kemungkaran yang ditegah oleh agama. Proses pembersihan rohani merupakan suatu proses yang berterusan sehinggalah kita kembali kepada Maha Pencipta suatu hari nanti.

Bagi merealisasikan konsep *tazkiyyah al-nafs*, salah satu cara yang boleh dipraktikkan menurut al-Quran adalah dengan melatih diri dan mendidik jiwa agar tahan dengan ujian hidup. Saranan ini bertepatan dengan surah Ali-Imran (3) ayat 186:

تَبْلُوكَ فِي أَمْوَالِكُمْ وَأَنْفُسِكُمْ وَلَسْمَعْتُمْ مِنَ الَّذِينَ أُوتُوا الْكِتَابَ مِنْ قَبْلِكُمْ

وَمِنَ الَّذِينَ أَشْرَكُوا أَذًى كَثِيرًا وَإِنْ تَصَبَّرُوا وَتَتَّقُوا فَإِنَّ ذَلِكَ مِنْ عَزْمِ الْأُمُورِ ﴿١٨٦﴾

“Kamu pasti akan diuji dengan hartamu dan dirimu. Dan pasti kamu akan mendengar banyak hal yang sangat menyakitkan hati daripada orang-orang yang diberi kitab sebelum kamu dan daripada orang-orang musyrik. Sekiranya kamu bersabar dan bertakwa, maka sesungguhnya yang demikian itu termasuk urusan yang patut diutamakan.”

⁵³ Nur Najwa Hanani Abd Rahman, Akmaliza Abdullah, Siti Norlina Muhamad, Mohammad Naqib Hamdan & Abdul Basit Samat@Darawi. (2019). Pendekatan Psikologi Dakwah dalam Menangani Masalah Saudara Baru. *Seminar Serantau Dakwah Dalam Masyarakat Majmuk*, Persatuan Ulama' Malaysia, 276.

⁵⁴ Abd Aziz Mohd Zin. (1999). *Psikologi Dakwah*. Kuala Lumpur: Jabatan Kemajuan Islam Malaysia.

Dengan menghayati ayat di atas, akan timbullah kesedaran bahawa dunia ialah tempat ujian semata-mata. Akhlak yang dizahirkan semasa berhadapan dengan ujian tersebut akan menentukan kedudukan seseorang di sisi Allah SWT sama ada kita menunjukkan sifat yang rendah dan hina atau menonjolkan keperibadian yang tinggi dan mulia. Di sinilah terletaknya kunci kepada ketenangan hati agar sentiasa luhur dan bersih daripada sebarang kenistaan dan kejelikan yang dapat merosakkan pahala seseorang. Oleh sebab itu, tidak hairanlah Ebit Lew sentiasa memperingatkan agar setiap jiwa perlu sentiasa dihubungkan dengan Zat Yang Maha Esa melalui pelbagai amalan ketaatan dan kesolehan demi mengecapi redha-Nya.

CABARAN PERJUANGAN DAKWAH EBIT LEW TERHADAP GOLONGAN ASNAF

Ebit Lew menjalankan gerak kerja dakwah dengan penuh tekanan dan cabaran. Tindakan beliau memuat naik bantuan yang diberikan secara terbuka untuk tatapan umum kurang disenangi oleh segelintir pihak. Mereka berpendapat bahawa beliau sewajarnya menyampaikan bantuan secara beradab, bersembunyi dan tidak menunjuk-nunjuk. Antaranya ialah Ustaz Abu Syafiq yang berpendapat bahawa haram menyiarkan gambar dan video orang miskin atau penerima sumbangan kerana tindakan tersebut akan menjatuhkan air muka serta mengaibkan mereka yang terlibat. Kontroversi yang menimpa Ebit Lew menjadi tular sehingga menarik perhatian Menteri di Jabatan Perdana Menteri, Datuk Dr Zulkifli Mohamad Al-Bakri yang terbuka untuk mengadakan pertemuan dengan beliau untuk mencari solusi terbaik berkaitan urusan bantuan yang menjadi dilema rakyat, termasuklah umat Islam.⁵⁵ Sungguhpun begitu, beliau mendapat sokongan yang padu daripada masyarakat pelbagai kaum yang mengharapkan usaha murni beliau akan berterusan.

Ebit Lew pernah dipanggil oleh pihak berkuasa untuk memberi keterangan di Balai Polis Bukit Aman pada 24 April 2020 berikutan reaksi orang awam mengenai tindakannya memaparkan kerja-kerja kebajikan ketika negara kita masih dalam tempoh PKP⁵⁶. Insiden ini berlaku susulan laporan polis yang dibuat ke atas beliau oleh beberapa pihak yang ternyata kurang senang dengan pendekatan beliau yang memberi sumbangan kepada para petugas barisan hadapan dan golongan yang memerlukan berikutan pandemik COVID19⁵⁷. Beliau juga tidak dibenarkan untuk meneruskan misi bantuan di pulau-pulau di Semporna, Sabah untuk mengelakkan hukuman sama ada didenda sebanyak RM 100 ribu atau penjara selama 3 tahun.⁵⁸ Rentetan itu, beliau terpaksa menanggungkan pembinaan sekolah atau pusat kegunaan masyarakat setempat yang telah dirancang buat semua penduduk Bajau Laut iaitu kumpulan manusia tanpa negara yang telah diislamkan.

Terdahulu, Ebit Lew yang menziarahi sepasang suami isteri yang uzur di sebuah rumah yang hampir roboh di Kampung Tapang, Kota Bharu telah memindahkan mereka sekeluarga setelah 20 tahun menumpang di tanah orang. Keadaan kesihatan mereka yang merosot ditambah pula dengan kepayahan bekerja menyukarkan kehidupan seharian mereka. Lawatan

⁵⁵ Syed Azwan Syed Ali. (2020). *Zulkifli Nak Jumpa Ebit Lew*. Diakses 14 Mac 2021, <https://alhiarahnews.com/zulkifli-nak-jumpa-ebit-lew/>

⁵⁶ PKP yang berkuatkuasa mulai 18 Mac 2020 adalah susulan penularan virus COVID-19. Larangan perjalanan dan penutupan kebanyakan premis kerajaan dan swasta diperketatkan bagi memutuskan rantaian COVID-19. Lihat, <https://www.mkn.gov.my>

⁵⁷ Novel Coronavirus 2019 (COVID-19) merupakan suatu jenis penyakit jangkitan saluran pernafasan yang disebabkan oleh virus. Penyakit ini menular melalui titisan-titisan dari batuk bersin atau pada permukaan yang terdedah. Lihat <http://covid-19.moh.gov.my/>

⁵⁸ Ebit Lew Supporters [t.me/TeamEbitLew]. (2021, Februari 2). Saya hati. Saya minta maaf kepada penduduk di pulau-pulau di Semporna yang saya Islamkan. Saya tidak dapat lagi meneruskan misi bantuan. Telegram. <https://telegram.org>

beliau mendapat serangan balas daripada Ahli DUN Panchor merangkap Timbalan Menteri Besar Kelantan, Yang Berhormat Ustaz Dato' Haji Mohd Amar Bin Nik Abdullah yang mengatakan bahawa, “Kebaikan yang tidak berakal akan mencetuskan fitnah yang berangkai”.⁵⁹ Tindakan Ebit Lew yang terus membantu penduduk di kawasan beliau tanpa merujuk kepada pihaknya terlebih dahulu seolah-olah memberi gambaran bahawa beliau tidak peka menangani isu berkenaan.

Ebit Lew yang menyediakan perkhidmatan bas untuk membawa pulang ratusan pelajar dalam tempoh PKP terpaksa menanggukkan 20 buah bas sehingga diberi kelulusan oleh Naib Canselor Universiti Perguruan Sultan Idris (UPSI). Beliau menerima kenyataan rasmi daripada Majlis Perwakilan Pelajar UPSI yang memberi peringatan kepada beliau agar mematuhi segala peraturan dan Prosedur Operasi Standard (SOP) berikutan polemik COVID19.⁶⁰ Beliau telah dihubungi dan diminta agar mengemukakan permohonan maaf secara terbuka kerana bertindak tanpa memohon kebenaran daripada pihak pengurusan UPSI yang berkait juga dengan pihak Kementerian Pengajian Tinggi (KPT) dan Majlis Keselamatan Negara (MKN) dalam memastikan keselamatan para pelajar sepanjang perjalanan pulang ke kampung masing-masing. Apabila mengenangkan bahawa beliau juga pernah menghadapi kesukaran sewaktu belajar dahulu beliau tidak berfikir panjang untuk tampil menghulurkan bantuan. Namun, beliau tetap akur dengan senario semasa yang menuntut agar segala tatacara keselamatan dipatuhi.

KESIMPULAN

Kehadiran Ebit Lew dalam persada dakwah tanah air sangat menonjol dalam perjuangannya membela nasib golongan asnaf bagi meningkatkan kelangsungan terhadap keupayaan ekonomi mereka. Ketokohan beliau membantu golongan fakir dan miskin banyak memudahkan urusan kehidupan mereka dan tanggungan bagi memenuhi keperluan makanan, pakaian dan tempat tinggal di samping menerima kemudahan pendidikan, perubatan dan pengangkutan yang sewajarnya. Sokongan spiritual dan motivasi turut diberikan sebagai salah satu galakan yang boleh menaikkan semangat golongan asnaf agar tidak berputus asa dalam menjalani kehidupan yang mencabar dengan berpandukan Al-Quran dan sunnah Rasulullah SAW. Dengan itu, selain Ebit Lew dapat memperbaiki taraf hidup mereka dan meningkatkan sumber pencarian yang lebih menjamin masa hadapan, kualiti peribadi muslim turut dipupuk agar mencapai keseimbangan bagi kesejahteraan hidup duniawi dan ukhrawi.

Perjuangan Ebit Lew kini menjadi suatu keperluan apabila merujuk kepada situasi semasa negara apabila pertambahan bilangan orang yang jatuh miskin semakin mendadak setelah fasa pandemik COVID19. Beliau memperluaskan misi kemanusiaan dengan mendekati juga masyarakat *non-muslim* dan menyantuni mereka. Beliau turun ke lapangan untuk menjejaki pelbagai lapisan masyarakat yang kurang bernasib baik serta menghulurkan sumbangan sebagai salah satu kewajipan dakwah yang mesti ditunaikan. Hakikatnya, segala ikhtiar yang dilakukan oleh Ebit Lew wajar dihargai malah berpotensi untuk menjadi sumber inspirasi kepada seluruh rakyat Malaysia amnya dan semua masyarakat Islam khususnya agar turut sama menyumbang. *Dakwah bil hal* sebegini secara zahirnya mempunyai dorongan

⁵⁹ Dato' Nik Amar [facebook.com/datonikamar]. (2020, Mei 14). Kebaikan yang tidak berakal akan mencetuskan fitnah yang berangkai. Facebook. <https://www.facebook.com>

⁶⁰ Ebit Lew Supporters [t.me/TeamEbitLew]. (2020, Oktober 4) Saya mohon maaf kepada pihak pentadbiran UPSI terutama yang dihormati Vice Canselor UPSI sendiri yang menghubungi pihak saya tadi. Telegram. <https://telegram.org>

praktikal yang lebih berkesan bagi memperkenalkan Islam secara realiti melalui bantuan kemanusiaan sejagat seperti yang sedang dibangunkan oleh Ebit Lew.

RUJUKAN

- Abd Aziz Mohd Zin. (1999). *Psikologi Dakwah*. Kuala Lumpur: Jabatan Kemajuan Islam Malaysia.
- Abdul Manam Mohamad Al-Merbawi. (2019). *Jalan Taqarrub Kepada Allah SWT*. Diakses 5 Jun 2022, <https://muftins.gov.my/2019/04/19/tazkiyat-al-nafs-jalan-taqarrub-kepada-allah-s-w-t/>
- Al-Quran Karim
- Andrew P. Johnson. (2014). *Education Psychology: Theories of Learning and Human Development*. Washington, DC: National Science Press.
- Astro Awani. (2020, Ogos 15). *Hari Belia Negara 2020: Dekad Ini Dekad Anda* [Video]. YouTube. <https://www.youtube.com/watch?v=XHkeGTauN6w>
- Burnell, J.D dan Galster, G. (1992). Quality of Life and Urban Size: An Empirical Note. *Urban Studies* (29), 727-735.
- Clint Grider. (1993). *Foundations of Cognitive Theory: A Concise Review*. Diakses 1 Mac 2022, <https://files.eric.ed.gov/fulltext/ED372324.pdf>
- Dato' Nik Amar [facebook.com/datonikamar]. (2020, Mei 14). Keabakan yang tidak berakal akan mencetuskan fitnah yang berangkai. Facebook. <https://www.facebook.com>
- Ebit Lew. (2018). *11 Amalan Memiliki Kekayaan*. Bangi, Selangor: Transform Publication.
- Ebit Lew. (2021). *Saya Pernah Tidur di Masjid, Pernah Tidur Atas Guni. Duit Gaji Bagi Dekat Emak Semua*. Diakses 24 Februari 2021, <https://www.facebook.com/ebitlew>
- Ebit Lew Supporters [t.me/TeamEbitLew]. (2020, September 30). Terharu dapat hantar anak ini masuk sekolah. Alhamdulillah syukur. Tak sampai 2 jam dah dapat masuk sekolah baru. Telegram. <https://telegram.org>
- Ebit Lew Supporters [t.me/TeamEbitLew]. (2020, Oktober 4). Saya mohon maaf kepada pihak pentadbiran UPSI terutama yang dihormati Vice Cancelor UPSI sendiri yang menghubungi pihak saya tadi. Telegram. <https://telegram.org>
- Ebit Lew Supporters [t.me/TeamEbitLew]. (2020, Oktober 16). Saya terus kata siapa nak masuk madrasah. Sekolah agama. Asrama. Nanti ustaz bayarkan yuran semua. Adik keluar dari sini. Telegram. <https://telegram.org>
- Ebit Lew Supporters [t.me/TeamEbitLew]. (2021, Januari 21). Pohon doakan yer. Baru beli biji 100 Tab untuk dihadiahkan pada pelajar yang memerlukan untuk kelas online. Telegram. <https://telegram.org>
- Ebit Lew Supporters [t.me/TeamEbitLew]. (2021, Februari 2). Sayu hati. Saya minta maaf kepada penduduk di pulau-pulau di Semporna yang saya Islamkan. Saya tidak dapat lagi meneruskan misi bantuan. Telegram. <https://telegram.org>
- Ebit Lew Supporters [t.me/TeamEbitLew]. (2021, Februari 8). Gong Xi Fa Cai. Happy CNY. Ziarah di Ulu Yam. Hadaiahkan basikal baru, angpow, barang dapur Elewsmart dan limau. Telegram. <https://telegram.org>
- Ebit Lew Supporters [t.me/TeamEbitLew]. (2021, Februari 12). Gembira sangat dapat adakan FoodBank kampung Cina di Sungai Sayong, Renggam Johor. Telegram. <https://telegram.org>
- Ebit Lew Supporters [t.me/TeamEbitLew]. (2021, Februari 17). Saya melawat ke Tokong Wat Nikrodharam di Alor Setar. Bawa sedikit angpow dan berkongsi kasih sayang. Telegram. <https://telegram.org>

- Ebit Lew Supporters [t.me/TeamEbitLew]. (2021, Mac 1). Saya nak hadiahkan 1000 cermin mata berjumlah RM200,000 untuk pelajar yang memerlukan dari seluruh Malaysia. Telegram. <https://telegram.org>
- Eric Rucks. (2015). *Sigmund Freud's Theories of Personality*. Diakses 1 Mac 2022, <http://www.polsci.tu.ac.th/sigmund1.pdf>
- Fatin Farhana Ariffin. (2020). *Menunjuk-nunjuk Ada Sebab – Ustaz Ebit Lew*. Diakses 10 April 2022, <https://www.bharian.com.my/hiburan/selebri/2020/12/761433/menunjuk-nunjuk-ada-sebab-ustaz-ebit-lew>
- Fuadah Johari. (2004). *Keberkesanan Zakat dalam Mengatasi Masalah Kemiskinan di Negeri Melaka*. (Tesis Sarjana). Universiti Malaya, Kuala Lumpur.
- Hairunnizam Wahid, Sanep Ahmad & Mohd Ali Mohd Noor. (2004). Kesan Bantuan Zakat Terhadap Kualiti Hidup: Kajian Kes Asnaf Fakir dan Miskin. *The Journal of Muamalat and Islamic Finance Research*, 155.
- Huda Hussain. (2020). *Ustaz Kenapa Tolong Orang Begitu Begini? Ada Yang Berkata Teruk, Tak Bagus, Tak Baik – Ustaz Ebit Lew*. Diakses 10 April 2022, <https://gempak.com/intrend/ustaz-kenapa-tolong-orang-begitu-begini-ada-yang-berkata-teruk-tak-bagus-tak-baik-ustaz-ebit-lew-45355>
- Ku Mengharapkan Pengampunan Mu Ya Allah. (2012, Disember 2). *IKIM.FM Y.BHG. USTAZ EBIT LEW-001* [Video]. YouTube. <https://youtu.be/39EYGVXF9h0>
- MyBuzz. (2020, Disember 20). *AME2020 Ebit Lew – Anugerah WIRA* [Video]. YouTube. <https://youtu.be/SJPy6K-kwi4>
- Norzita Jamil dan Siti Halijah Che Mat. (2014). Realiti Kemiskinan: Satu Kajian Teoritik. *Jurnal Ekonomi Malaysia*. Pusat Pengajian Ekonomi dan Kewangan, UUM.
- Nurazynie Herman. (2019). *Kemiskinan Multi Dimensi: Pengkategorian Kemiskinan Golongan B40 Di Bandar Bayan Baru, Pulau Pinang*. (Tesis Sarjana). Universiti Sains Malaysia, Gelugor.
- Nur Najwa Hanani Abd Rahman, Akmaliza Abdullah, Siti Norlina Muhamad, Mohammad Naqib Hamdan & Abdul Basit Samat@Darawi. (2019). Pendekatan Psikologi Dakwah dalam Menangani Masalah Saudara Baru. *Seminar Serantau Dakwah Dalam Masyarakat Majmuk*, Persatuan Ulama' Malaysia, 276.
- Olusola Ayandele. (2016). *Basic Psychology*. Ibadan, Nigeria: Hope Publications Ltd.
- Saul McLeod. (2022). *Simply Psychology*. Diakses 27 Februari 2022, <https://www.simplypsychology.org/behaviorism.html>
- Syed Azwan Syed Ali. (2020). *Zulkifli Nak Jumpa Ebit Lew*. Diakses 14 Mac 2021, <https://alhijrahnews.com/zulkifli-nak-jumpa-ebit-lew/>

Penerimaan Pelajar Terhadap Aplikasi *Google Classroom* dalam Mata Pelajaran Pendidikan Islam

Mardhiatul Munirah Ramli
Universiti Kebangsaan Malaysia (UKM)
p11219@siswa.ukm.edu.my

Mohd. Isa Hamzah
Universiti Kebangsaan Malaysia (UKM)
isa_hamzah@ukm.edu.my

ABSTRACT

The use of Google Classroom has become a popular issue among teachers especially during the pandemic outbreak of covid 19. The use of Google Classroom is one of the applications recommended by the Ministry of Education Malaysia in implementing the process of Teaching and Learning at home. This library study was conducted to find out students' perceptions of the Google Classroom application in Islamic Education Subjects. The results of the study have proved that the percentage rate that supports the implementation of Google Classroom is at a high percentage level. In conclusion, it is hoped that this study can be a reference material, especially to the Ministry of Education Malaysia and Islamic Education teachers for further action to improve student performance in the subject of Islamic Education.

Keywords: *Student Acceptance; google classroom; ICT; impact of ICT; Pandemic Covid-19*

ABSTRAK

Penggunaan Google Classroom menjadi satu isu yang popular dalam kalangan guru terutamanya ketika penularan wabak pandemik covid-19. Penggunaan Google Classroom adalah salah satu aplikasi yang disarankan oleh Kementerian Pendidikan Malaysia dalam melaksanakan proses Pengajaran dan Pembelajaran di rumah. Kajian perpustakaan ini dijalankan bagi mengetahui penerimaan pelajar terhadap aplikasi Google Classroom dalam Mata pelajaran Pendidikan Islam. Hasil dapatan kajian telah membuktikan bahawa kadar peratusan yang menyokong pelaksanaan Google Classroom berada pada tahap peratusan yang tinggi. Kesimpulannya, diharapkan kajian ini mampu menjadi bahan rujukan terutamanya kepada Kementerian Pendidikan Malaysia serta guru-guru Pendidikan Islam untuk tindakan seterusnya bagi meningkatkan prestasi pelajar dalam mata pelajaran Pendidikan Islam.

Kata kunci: *Penerimaan Pelajar; google classroom; ICT; kesan penggunaan ICT; Pandemik*

PENGENALAN

Kepesatan pembangunan era globalisasi memberi impak kepada sistem pendidikan terutamanya dalam mengikuti arus pemodenan. Perkembangan sistem teknologi maklumat telah menuntut sistem pendidikan dalam melakukan perubahan bagi melahirkan insan yang berdaya saing dan kompeten. Pengaplikasian ICT mampu meningkatkan kualiti pendidikan negara jika ia digunakan. Selain itu, mampu meninggikan minat dan motivasi pelajar serta mempercepatkan proses pembelajaran.

Negara mengalami perubahan era iaitu era perkembangan teknologi maklumat yang mempengaruhi pelbagai aspek kehidupan manusia. Era globalisasi ini merupakan satu proses penyatuan dunia dalam beberapa bidang tertentu. Tidak ketinggalan juga dalam dunia Pendidikan, Bermula pada tahun 2014, KPM telah memperkenalkan sistem Pendidikan Abad

ke-21. Pendidikan Abad ke-21 ini dilaksanakan selari dengan arus pemodenan negara bagi melahirkan murid yang berkemahiran dan berdaya saing.

Pembelajaran PAK 21 harus mencerapkan pengalaman persekolahan relevan serta kebolehan yang perlu diperoleh oleh murid dalam kehidupan mereka. Sistem pembelajaran yang dimaksudkan ialah pembelajaran yang boleh menyediakan masa depan murid serta penglibatan dalam menyelesaikan masalah sebenar dalam kehidupan untuk menangani cabaran hidup. Oleh hal demikian, guru perlu menggunakan kaedah pengajaran yang sesuai dan relevan supaya murid dapat menguasai pelbagai kemahiran.

KPM telah menjalankan program pembestarian sekolah supaya guru dan murid terbiasa menggunakan ICT dalam pengajaran dan pembelajaran bagi meningkatkan motivasi serta kualiti pembelajaran murid. Bagi menjayakan program ini, guru-guru perlu menggunakan kaedah pembelajaran berasaskan ICT. Menurut kajian Halili dan Suguneswary (2016) dengan menggunakan bantuan teknologi dalam pengajaran dan pembelajaran (PdP) guru mampu menggunakan pelbagai kaedah dan strategi pembelajaran serta meningkatkan prestasi pembelajaran yang berpusatkan murid.

Pembelajaran berunsurkan multimedia sudah banyak diperkatakan baik dari pihak guru, pensyarah, penyelidik mahupun kementerian Pendidikan Malaysia. Hal ini dikatakan mampu meningkatkan kualiti pengajaran dan pembelajaran pelajar kerana mempunyai gabungan elemen teknologi yang menarik. Namun proses ini turut bergantung kepada usaha dan amalan guru dalam melaksanakannya (Maimun, Wan Nurul, Mohd Isa, 2017).

Kementerian Pendidikan Malaysia (KPM) telah menggariskan memanfaatkan ICT bagi meningkatkan kualiti pembelajaran di Malaysia dalam anjakan ke-7 yang terkandung dalam Pelan Pembangunan Pendidikan Malaysia 2013-2025. Hal ini menunjukkan bahawa dunia Pendidikan pada masa kini sangat bergantung kepada ICT.

PERNYATAAN MASALAH

Pendidikan Islam merupakan subjek teras wajib yang perlu diajar kepada murid. Hal ini kerana untuk melahirkan muslim yang berilmu dan berakhlak mulia berdasarkan Al-Quran dan As-Sunnah supaya menjadi khalifah Allah yang bertakwa serta menyumbang ke arah mempertingkatkan tamadun bangsa dan negara.

Falsafah Pendidikan Islam merupakan usaha yang berterusan dalam menyampaikan ilmu berdasarkan Al-Quran dan As-sunnah bagi membentuk pandangan hidup sebagai hamba Allah yang mempunyai tanggungjawab untuk membangunkan diri, masyarakat, alam sekitar dan negara ke arah mencapai kebaikan dunia dan kesejahteraan akhirat (KSSR, 2015).

Justeru itu, pendidikan Islam merupakan mata pelajaran yang penting dalam membentuk akhlak yang mulia namun sehingga kini ia menjadi persoalan mengenai kemampuan subjek ini dalam menjana akhlak yang mulia. Seterusnya, Pendidikan Islam sering dilihat mundur dan menjadi punca peyumbang kepada masalah ini (Azhar, Nurul, 2017).

Akhir sekali, guru Pendidikan Islam masih menggunakan kaedah konvensional seperti *chalk and talk*. Hal ini disokong oleh Mansor dan Zakaria, (2021) yang mendapati pendidik lebih gemar dan selesa menggunakan kaedah konvensional berbanding menggunakan ICT. Hal ini menyebabkan pelajar menjadi bosan dan jemu dalam mata pelajaran Pendidikan Islam.

Guru memainkan peranan yang penting untuk memastikan objektif pembelajaran tercapai dengan menyampaikan pengajaran yang mampu mendekatkan ilmu agama dengan jiwa murid. Tambahan pula, pandemik COVID-19 telah memberi kesan kepada dunia Pendidikan terutamanya. Penutupan institusi dan sekolah menyebabkan struktur pembelajaran secara langsung bertukar kepada pembelajaran secara atas talian. Hal ini menjadi satu keperluan untuk pendidik mengaplikasikan teknologi dalam sistem pendidikan mereka.

TUJUAN DAN OBJEKTIF KAJIAN

Kajian ini dijalankan bagi mengetahui penerimaan pelajar terhadap aplikasi *Google Classroom* dalam mata pelajaran Pendidikan Islam.

- i. Untuk mengkaji penerimaan pelajar terhadap aplikasi *Google Classroom* dalam mata pelajaran Pendidikan Islam.
- ii. Untuk meneliti kesan penggunaan terhadap aplikasi *Google Classroom* dalam mata pelajaran Pendidikan Islam.

PERSOALAN KAJIAN

- i. Apakah penerimaan pelajar terhadap aplikasi *Google Classroom* dalam mata pelajaran Pendidikan Islam?
- ii. Apakah kesan penggunaan terhadap aplikasi *Google Classroom* dalam mata pelajaran Pendidikan Islam?

DEFINISI

Berikut merupakan definisi terhadap penerimaan, ICT dan *Google Classroom*. Dalam kajian James et al. (2019) menyatakan penerimaan merupakan sesuatu yang berkaitan dengan sikap seseorang samada menerima atau menolak sesuatu perkara. Menurut kamus Dewan (2013) penerimaan bermaksud sesuatu sikap menerima atau orang yang menerima sesuatu.

Seterusnya, ICT dalam bidang Pendidikan adalah pembelajaran yang menggunakan capaian internet dan kemudahan peranti seperti komputer peribadi, telefon pintar, alatan eletronik dan sebagainya. Menurut Zakaria et al. (2017) teknologi maklumat dan komunikasi merupakan peralatan yang mudah untuk berhubung kerana teknologi maklumat dan komunikasi memudahkan pengguna yang berada jarak yang jauh berkongsi maklumat dalam pelbagai bentuk

Google classroom merupakan satu platform pembelajaran yang ditawarkan oleh google bagi guru untuk mengadakan kelas secara atas talian (Melvina, 2022).

KAJIAN LITERATUR

Ujian Pandemik yang melanda seluruh negara telah memberi implikasi yang sangat besar kepada sistem pendidikan negara. Namun kepelbagaian wahana dalam merealisasikan pembelajaran agar tetap terus dijalankan seperti aplikasi *Google Classroom*. Peranti digital ini diakui merupakan alternatif yang dipersetujui oleh institusi pendidikan baik guru mahupun pelajar. *Google Classroom* diiktiraf sebagai pengganti teknik pembelajaran secara konvensional yang telah digunakan sebelum wabak Covid-19 menyerang marcapada ini. Malahan pelaksanaan pembelajaran menerusi medium ini turut dinilai sebagai efektif berdasarkan beberapa indikator. Kayu ukur yang pertama ialah kualiti pembelajaran, iaitu

sebanyak mana kadar maklumat yang diterima oleh pelajar di samping kadar kekurangan yang lebih sedikit. Indikator kedua ialah, tahap persediaan pelajar terhadap penggunaan *Google Classroom*, yang ketiga pula ialah insentif para guru dalam memastikan pelajar menyiapkan tugas yang diberikan dan yang terakhir ialah peruntukan waktu yang diberikan kepada pelajar dalam melunaskan tugas yang diberikan (Nia Maharani, 2021).

Salah satu jalan dalam menyelesaikan masalah pembelajaran mengenai pengkelasan tugas yang sistematik adalah dengan menggunakan aplikasi digital seperti *Google Classroom*. *Google Classroom* merupakan peranti yang berjaya mewujudkan ruang kelas secara alam maya. Ciri-ciri yang disediakan oleh aplikasi ini dapat dimanfaatkan bagi tujuan diskusi, menyampaikan pengumuman, pendistribusian tugas dan pengumpulan nota kepada pelajar. Dengan demikian, metod kemudahan yang telah disediakan oleh *Google Classroom* ini membantu guru untuk menganalisa nama-nama pelajar yang telah menyelesaikan tugas, mahupun pelajar yang culas dalam menyiapkan tugas yang telah diberikan tanpa perlu merujuk kepada pelajar itu sendiri. Peranti ini juga bersifat fleksibel yang mana menjimatkan masa para guru dan pelajar bagi mengakses laman yang dikendaki tanpa limitasi lokasi dan masa yang tertentu. Tambahan pula, kadar responsif atau tindak balas yang cekap turut membantu pelajar mengikuti pembelajaran dengan selesa, asalkan menerima capaian internet yang mencukupi (Wildatus, 2020).

Menurut kajian yang dijalankan oleh Gupta dan Pathania (2020) terhadap 60 orang murid mendapati mereka menunjukkan perasaan yang positif terhadap penggunaan *google classroom*. Murid dapat menggunakan kemudahan ini di mana jua serta memudahkan mereka untuk menanyakan soalan yang tidak difahami. Selain itu, ia mendapati murid berasa mudah berkolaboratif dengan murid lain serta meningkatkan minat mereka untuk belajar.

Google Classroom berupaya membantu pelajar dalam menyelesaikan beberapa permasalahan yang berkaitan dengan bidang akademik seperti proses memahami masalah (*understanding*), mencipta kerangka penyelesaian (*planning*), melakukan solusi (*solving*) dan membuat semakan (*checking*). Langkah demi langkah perlu dihadapi oleh pelajar dalam menyelesaikan kerja sekolah yang diperuntukkan oleh guru terhadap mereka. Antara peringkat pemecahan atau peleraian masalah mengenai sesuatu topik adalah dimulai dengan tahap atau kadar pengetahuan pelajar itu sendiri. Seterusnya, soalan yang terbit oleh pelajar berdasarkan apa yang tidak diketahui atau difahami oleh mereka dan seterusnya strategi yang dibina bagi memahami kehendak soalan yang diajukan (Gunawan, 2018 dalam Maharani, 2021). Meskipun subjek Pendidikan Islam tidak serumit subjek Matematik, namun tetap diselitkan soalan berunsur aras tinggi bagi mengasah kemahiran berfikir pelajar agar menguasai bab yang telah diajarkan.

Platform *Google Classroom* telah menggabungkan aplikasi-aplikasi dalam Google itu sendiri seperti *Google Drive*, *Google Docs*, *Google Sheets*, *Google Slide* dan sebagainya yang menyumbang manfaat sebagai peranti penyimpanan data secara pendekatan paperless. Di samping itu, terdapat juga pautan lain bagi tujuan ulang kaji pelajaran seperti *Quiziz*, *Kahoot*, *Quizlet*, *Plickers*, dan *Ed-Puzzle*. Variasi pautan ini dapat dimanfaatkan oleh tenaga pengajar bagi menyediakan bank soalan, latihan pengukuhan mahupun latihan tubi kepada para pelajar tanpa perlu lagi merujuk buku Latihan secara manual. Secara tidak langsung pelaksanaan alam maya yang canggih ini menepati saranan pembelajaran abad ke-21 yang menekankan aspek 4C iaitu *communication*, *collaboration*, *critical thinking* dan *creativity* sebagai asas kemahiran untuk bersaing di peringkat antarabangsa (M. Kaviza, 2020). Justeru kajian literatur ini telah

mengukuhkan alasan kepada pemilihan aplikasi *Google Classroom* sebagai antara teknologi pemudahcara yang sesuai dalam pelaksanaan PdPR bagi subjek Pendidikan Islam di sekolah.

METODOLOGI KAJIAN

Kajian ini dijalankan melalui kaedah menganalisis dokumen dan perpustakaan yang pelbagai. Pengkaji memperoleh maklumat yang diperlukan melalui jurnal, prosiding, buku dan laporan atas talian yang didapati dari enjin carian utama iaitu google chrome untuk mengakses laman web jurnal. Kata kunci yang digunakan dalam carian ini ialah “Penggunaan aplikasi *google classroom*”, “Penerimaan pelajar terhadap penggunaan ICT dalam pembelajaran” dan “kesan menggunakan ICT dalam pembelajaran”. Pengkaji meneliti bahan yang didapati berkaitan dengan tajuk yang dikaji dan bahan tersebut dijadikan sumber bacaan dan rujukan pengkaji. Kajian ini mengumpul sokongan kajian lepas yang bermula dari tahun 2016 hingga 2021.

DAPATAN KAJIAN

Meninjau dapatan kajian mengenai tahap kesediaan pelajar dalam menggunakan peranti *Google Classroom* dalam pembelajaran subjek Pendidikan Islam berada pada tahap tinggi. Manakala berdasarkan pengkelasan jantina, purata min pelajar lelaki lebih tinggi berbanding keputusan min bagi pelajar perempuan. Secara purata, kadar yang tinggi ini berikutan pelajar zaman kini merupakan golongan yang berada dalam kategori ‘Generasi Net’ (M. Kaviza. 2020). Kelompok yang dikelaskan sebagai ‘Generasi Net’ atau ‘Generasi Y’ merupakan golongan yang cenderung kepada pendedahan skop teknologi yang lebih luas lantaran dilahirkan dalam persekitaran ICT atau Teknologi Maklumat dan Komunikasi (TMK). Watak mereka turut mencerminkan identiti yang mempunyai kaitan dengan dunia digital yang berasaskan teknologi. Maka tidak hairanlah sekiranya mereka mempunyai paradigma sosial yang lebih kompleks dan mudah menerima pembaharuan (Santi, 2020).

Menerusi kajian yang berasingan, mendapati bahawa sejumlah 90% guru Pendidikan Islam mengakui mahir menggunakan peralatan teknologi bagi mengendalikan kelas secara alam maya. Manakala 91.25% pula menyatakan pemilikan terhadap peralatan teknologi seperti telefon pintar, *laptop* dan komputer meja. Pemilikan ini memberi kemudahan kepada para guru bagi mengadaptasi pembelajaran dengan kemudahan jalur lebar masa kini. Kebanyakan guru menambah bahawa mereka turut memiliki peralatan teknologi dan bersedia menggunakan data peribadi tanpa batasan bagi menjalankan P&P secara maya. Bahkan mereka menyuarakan kebebasan dalam membuat pilihan yang pelbagai mengenai aplikasi yang disediakan oleh *Google Classroom* seperti *Quizizz*, *Padlet*, *Edmodo* dan *Wordwall*. Separuh daripada mereka pula tidak berselindung mengenai ketidakpastian akan kelajuan internet bagi pihak pelajar bagi mengikuti kelas alam maya sepertimana yang telah dijadualkan.

Secara keseluruhannya, 51 responden dengan peratus sebanyak 63.75% berasa gembira dengan pelaksanaan *Google Classroom* manakala 21.25% memerlukan kaunseling yang khusus kerana tidak dapat memberikan fokus yang sepenuhnya dan merasa tertekan. Namun demikian, para guru tetap berusaha menangani masalah ini dengan memaklumkan agar pihak waris atau pelajar sendiri mengambil stok latihan yang telah disediakan di sekolah. Kajian turut mengamati mengenai dapatan kajian terhadap para pelajar. Seramai 78 responden dengan kadar peratus sebanyak 97.5% bersetuju dengan pembelajaran atas talian di mana ia tidak memberi ketetapan terhadap jumlah kehadiran para pelajar. Ini menunjukkan sejumlah kecil sahaja pelajar yang kurang bersetuju atau mengalami masalah dalam menyahut pembaharuan metod PdPR dengan menggunakan kaedah *Google Classroom*. Teknik pembelajaran atas talian

memberikan keringanan kepada proses pentaksiran dan pembelajaran yang berterusan dilakukan setiap hari, kecuali hari cuti sekolah (Fadzliyah, Farah, Fatahiyah, Nazrah & Radzi, 2020).

Bukan itu sahaja, responden mengakui kadar keselamatan yang terjamin melalui penggunaan aplikasi teknologi bagi mengelakkan plagiarisme dalam kalangan pelajar. Hal ini demikian kerana ID Pengguna atau kata laluan pelajar hanya dapat diakses oleh dua pihak sahaja iaitu pelajar terbabit dan juga guru bagi subjek Pendidikan Islam itu sendiri. Dengan demikian, ia memberi jaminan perlindungan kepada hasil akademik pelajar. Keberangskalian yang tipis sekiranya tugas pelajar dapat diceroboh masuk oleh pelajar yang lain tanpa keizinan. Aplikasi pembelajaran elektronik juga dianggap mesra pengguna kerana menggalakkan perkongsian maklumat secara kolaboratif sesama pelajar mahupun guru meskipun tidak berlaku secara formal. Meskipun kaedah pedagogi guru telah berubah, namun ia tetap menyumbang kepada Teknik pembelajaran sendiri yang lebih menguntungkan kepada pelajar. Tuntasnya, dapatan kajian ini tidak bersifat berat sebelah kerana memandangkan daripada aspek kedua-dua belah pihak iaitu guru mahupun pelajar kerana dua pihak inilah yang mendominasi pembelajaran secara atas talian iaitu *Google Classroom* serta aplikasi yang terangkum di bawahnya.

PERBINCANGAN KAJIAN

Sesungguhnya pelbagai iktiar dirancang dan bincangkan oleh institusi pentadbiran sekolah, agar pelajar tidak tercicir dalam pembelajaran meskipun negara menghadapi bencana Covid-19. Antara usaha lain yang dipilih oleh para guru adalah menerusi pembelajaran atas talian atau *Google Classroom*. Meskipun dapatan kajian telah membuktikan bahawa kadar peratusan yang menyokong pelaksanaan *Google Classroom* berada pada tahap peratusan yang tinggi, namun masih terdapat kekusaran yang timbul oleh sesetengah pihak. Antaranya ialah kekurangan kemudahan yang dihadapi oleh sebilangan kecil para pelajar. Pelajar yang berlatar belakangkan asal keluarga yang susah dan bertaraf hidup rendah seperti B40 tidak memiliki telefon pintar peribadi. Maka menjadi kesukaran untuk berkongsi dengan adik beradik yang lain yang turut menjalankan PdPR secara atas talian.

Bukan itu sahaja, masalah capaian internet yang perlahan juga menjadi faktor kesukaran bagi pelajar dalam mengikuti kelas secara atas talian. Malahan terdapat pelajar yang tidak mempunyai data internet langsung kerana tinggal di kawasan pedalaman. Dari pihak guru pula, mengalami keraguan mengenai teknik cuba jaya iaitu memilih tindakan yang paling sesuai bagi pelajar agar tetap dapat menerima pembelajaran sebagaimana pelajar-pelajar yang lain. Implikasi ini dilihat sebagai topik perbincangan yang sukar diselesaikan kerana telah menjadi masalah yang berakar umbi dan masih wujud sehingga sekarang. Namun demikian usaha mengenalpasti tahap kebolehan capaian internet bagi setiap pelajar telah membantu guru memudahkan pembelajaran dan memikirkan kaedah kreatif bagi menangani isu ini (Fadzliyah et al., 2020).

Penggunaan tulisan jawi secara optima tidak dapat diadakan kerana tidak semua pelajar mempunyai akses kepada kemudahan ini. Hal ini demikian kerana kebanyakan pelajar tidak mempunyai kemudahan yang lebih canggih yang melibatkan papan kunci *keyboard* atau *keypad* yang berhuruf jawi. Sedangkan masalah pemilikan telefon pintar secara peribadi tidak dimiliki oleh para pelajar, inikan pula kemudahan akses yang lebih tinggi daripada itu. Sudah tentu lama kelamaan penggunaan tulisan jawi dalam Pendidikan Islam semakin dilupakan oleh para pelajar dengan alasan yang munasabah iaitu faktor kekurangan peralatan teknologi dalam

mengecap arus perubahan pendidikan yang berasaskan teknologi secara holistik. Tentunya tidak adil sekiranya pelajar yang mempunyai akses tulisan jawi sahaja yang berjaya mengikuti pembelajaran Pendidikan Islam sebaiknya, sedangkan rata-rata pelajar sekelas yang lain adalah sebaliknya.

Perbincangan seterusnya yang dilihat penting malah mencengkam jiwa majoriti orang adalah mengenai aspek pengurusan emosi individu yang terlibat dengan PdPR secara atas talian. Selain masalah internet dan gajet yang berlaku sepihak sahaja, masalah lain yang mempengaruhi pembelajaran atas talian juga adalah mengenai gangguan emosi atau stress yang dihadapi oleh guru dan pelajar. Bagi guru, masalah komputer *lag* atau *screen freez* akibat penggunaan laptop secara berterusan turut mengganggu kelancaran tugasan. Selain itu, desakan penyediaan modul yang lebih kreatif dan inovatif bagi menjalankan PdPR secara atas talian turut menjadikan minda dan kemampuan guru sangat penat dan lesu. Selain itu, para guru menzahirkan kurang selesa akibat tindak balas pelajar yang pasif semasa proses PdPR atas talian dijalankan. Maka komunikasi lisan secara dua hala tidak berjaya mencapai standard yang berkesan, sebagaimana yang berlaku semasa pembelajaran secara bersemuka. Setidaknya, para guru mengharapkan sebahagian besar pelajar bertindak aktif kerana Kaedah *Google Classroom* mengizinkan pembelajaran menjadi inovatif sekiranya guru dapat membalas pandangan sewaktu sesi soal jawab diadakan. Namun, ia tidak seperti yang diharapkan.

Dengan begitu, sokongan kaunseling amat perlu dalam membantu para guru meluahkan tekanan yang dihadapi sebelum masalah yang lebih serius terjadi terhadap institusi pendidikan. Maka jadual yang disediakan kepada guru perlu mengambil kira pelbagai aspek tanpa memberi tekanan yang maksima terhadap bebanan tugas sedia ada bagi pihak guru. Hakikatnya, pihak lain yang turut terlibat dalam implikasi PdPR atas talian ialah PIBG atau secara spesifiknya adalah ibu bapa kepada pelajar itu sendiri. Hal ini demikian kerana desakan anak-anak untuk mengikuti kelas atas talian yang diwajibkan ke atas mereka, sedangkan tidak berkemampuan dalam aspek penyediaan alatan digital yang dikehendaki. Ibu bapa yang kesuntukan dalam bab kewangan mengalami resah sanubari memikirkan solusi dalam memenuhi hak pendidikan terhadap kesemua anak-anaknya. Manakala anak-anak menjadi semakin kurang minat dan motivasi dalam menelaah ilmu berikutan masalah kesusahan yang dihadapi. Apa yang dapat disimpulkan ialah, permasalahan ini amat sukar untuk diatasi dengan saksama kerana melibatkan banyak aspek. Justeru, korelasi semua pihak amat diharapkan agar mampu memberikan kerjasama sebaiknya demi pendidikan yang terbaik kepada para pelajar dalam era pandemik ini.

RUMUSAN

Melihat dari sisi lain yang lebih positif, penularan wabak Covid-19 ini secara automatik meningkatkan profesionalisme perguruan dalam memahirkan para pendidik bagi mengendalikan laman digital yang kian mencabar saat ini. Para guru terpaksa meneroka teknik pedagogi yang lebih canggih dan berbeza dengan metod pelaksanaan PdPR yang dijalankan secara konvensional sebelum ini. Bagi guru yang belum pernah melayari dan menggunakan peranti *Google Classroom*, terpaksa menyemai minat agar aplikasi ini dapat diakses dengan berjaya. Para guru juga sedaya yang mampu dalam memvariasi kaedah pembelajaran demi menarik minat dan perhatian pelajar agar mengikuti kelas sehingga selesai, lebih-lebih lagi bagi subjek Pendidikan Islam. Baik pendidik sendiri tidak segan silu bagi mempelajari penggunaan peranti digital, meskipun daripada pelajar mereka sendiri agar dapat menyumbangkan hasil yang lebih bermutu kepada para pelajar. Impak positif turut dialami oleh para pelajar kerana pembelajaran atas talian mampu mengurangkan tahap mengantuk, seterusnya meningkatkan

fokus dalam pembelajaran lantaran terdapat selingan muzik dan lagu. Paparan animasi secara kinetik juga digunakan oleh guru pada papan skrin pembelajaran demi minarik minat dan melahirkan rasa seronok sewaktu kelas dijalankan. Oleh yang demikian, daya juang dan komitmen pelajar amat diharapkan agar pembelajaran secara atas talian terus bersemangat untuk terus dilakukan pada hari muka.

RUJUKAN

- Azhar Muhammad & Nurul Huda Abd Wahab. (2017). Aplikasi ICT dalam Pengajaran Pendidikan Islam Semasa Latihan Mengajar. *Universiti Teknologi Malaysia Institutional Repository*. Retrieved 25 june 2022 from <http://eprints.utm.my/id/eprint/10244/>
- Che Nazrah Mohd Yusof, Fadzliyah Hashim, Farah Farhana Rosli, Fatahiyah Elias & Mohd Radzi Lebai Mat. (2020). *Pengajaran Dan Pembelajaran Atas Talian Dan Impaknya Terhadap Guru Novis Pendidikan Islam*. Bitara International Journal Of Civilization Studies And Human Sciences. Volume 3, Issue 4 (2020). Retrieved 19 june 2022 from <https://bitarajournal.com/index.php/bitarajournal/article/view/163/148>
- Dewan, K. (2013). *Kamus Dewan Bahasa dan Pustaka*.
- Gupta, A. & Pathania, P. (2020). To study the impact of Google Classroom as a platform of learning and collaboration at the teacher education level. *Education and Information Technologies*, 26, 843-857.
- Halili, S. H., & Suguneswary. (2016). Penerimaan Guru Terhadap Penggunaan Teknologi Maklumat dan Komunikasi Berasaskan Model TAM dalam Pengajaran Mata Pelajaran Bahasa Tamil. *Jurnal kurikulum & Pengajaran Asia Pasifik*.
- James, D. J., Sharif, S., & Singh, S. B. (2019). Penerimaan Penggunaan Mobile Learning di kalangan Pelajar Tingkatan 6 dalam Mata Pelajaran Geografi. *Malaysia Journal of Social Sciences and Humanities*, 4(6), 101-107. DOI: <https://doi.org/10.47405/mjssh.v4i6.282>
- Mansor, S., & Zakaria, M. A. (2021). Penerimaan Guru terhadap Penggunaan Google Classroom Semasa Proses PdP Secara dalam Talian Menggunakan Model TAM. *Researchgate*.
- Maimun Aqsha Lubis, Wan Nurul Syuhada' Wan Hassan & Mohd Isa Hamzah. (2017). Tahap Pengetahuan dan Kesiediaan Guru-guru Pendidikan Islam Sekolah Menengah di Selangor Terhadap Penggunaan Multimedia dalam Pengajaran Pendidikan Islam. *ASEAN Comparative Education Research Journal on Islam and Civilization (ACER-J)*. 1(1): 1-13. Retrieved 1 june 2022 from <http://spaj.ukm.my/acerj/index.php/acerj/article/view/3>
- Melvina, C. H. (2022). Google Classroom sebagai Salah Satu Platform Dalam Penyampaian Pengajaran Dan Pembelajaran: Satu Kajian Tinjauan. *Jurnal Kurikulum & Pengajaran Asia Pasifik*.
- M. Kaviza. (2020). *Kesediaan Murid Terhadap Aplikasi Google Classroom Sebagai Platform Pembelajaran Sejarah*. *Malaysian Journal Of Social Science And Humanities (MJSSH)* Volume 5, Issue 4. (Hlmn 108-115). Retrieved 12 july 2022 from <https://msocialsciences.com/index.php/mjssh/article/view/397/282>
- Nia Maharani. (2021). *Penggunaan Google Classroom Sebagai Pengembangan Kelas Virtual Dalam Keterampilan Pemecahan Masalah Sebelum Dan Saat Pandemi Covid-19*. *Journal Of Science Education*, 2021; 5 (1), 23-29. Retrieved 13 may 2022 from <https://ejournal.unib.ac.id/index.php/pendipa/article/view/9264>

- Kurikulum Standard Sekolah Rendah. (2015). *Pendidikan Islam Tahun Enam*. Kementerian Pendidikan Malaysia. Retrieved 15 may 2022 from <https://www.moe.gov.my/muat-turun/penerbitan-dan-jurnal/dskp-kssr>.
- Santi Widianti. (2020). *Konektivitas Dan Kolaborasi: Peran Information Communication Information (ICT) Sebagai Enabler Musisi Generasi Net Indonesia Menembusi Industri Musik Global*. Jurnal Budaya Nusantara. Vol. 4 No. 1 (2020). Retrieved 25 june 2022 from http://jurnal.unipasby.ac.id/index.php/jurnal_budaya_nusantara/article/view/3244
- Wildatus Salamah. (2020). *Deskripsi Penggunaan Aplikasi Google Classroom Dalam Proses Pembelajaran*. Jurnal Penelitian Dan Pengembangan Pendidikan. Vol. 4 (3) pp.533-538. Retrieved 10 august 2022 from <https://ejournal.undiksha.ac.id/index.php/JJL/article/view/29099>
- Zakaria, S. R., Hamzah, M. I., & Razak, K. A. (2017). Penggunaan ICT dalam Pengajaran dan Pembelajaran Pensyarah Pendidikan Islam di Politeknik Zon Selatan. *Tinta Artikulasi Membina Ummah*.

Pengujian Modul Sensor menggunakan Multimeter bagi membina Jadual Kebenaran dan Pseudokod

Sheilani Binti Shaari
Politeknik Kota Bharu
sheilani@pkb.edu.my

Nik Nor Hishamuddin Bin Nik Mustapha
Politeknik Kota Bharu
hishamuddin@pkb.edu.my

ABSTRAK

Penggunaan sensor di dalam teknologi masa kini banyak diaplikasikan dalam hampir semua bidang kehidupan. Oleh itu, pengetahuan tentang sensor ini menjadi sangat penting untuk dipelajari dan difahami terutamanya bagi pelajar kejuruteraan. Kertas kajian ini menerangkan prinsip asas di dalam pengujian modul sensor hanya dengan menggunakan multimeter seterusnya membina jadual kebenaran bagi menghasilkan pseudokod. Pengujian hanya melibatkan beberapa jenis modul sensor yang biasa digunakan oleh pelajar dalam menghasilkan projek. Pengujian adalah secara pemerhatian terhadap status persekitaran dan status LED pada modul sensor, serta pengukuran nilai voltan pada DO menggunakan multimeter. Hasil keputusan pengujian nilai voltan yang diukur pada pin DO adalah sebagai penentuan status digital sensor berkaitan sama ada 1 atau 0. Status digital ini boleh diaplikasikan sebagai masukan kepada projek yang menggunakan pengawal mikro seperti Arduino UNO, ESP32 atau Raspberry Pi. Data ini digunapakai untuk membina jadual kebenaran bagi menghasilkan pseudokod. Pengujian seperti ini boleh dijadikan sebagai sumber rujukan kepada pelajar kejuruteraan dalam membuat ujian terhadap komponen elektronik yang lain semasa melaksanakan projek. Pembinaan jadual kebenaran dan pseudokod merupakan kemahiran asas yang perlu ada bagi setiap pelajar kejuruteraan untuk membuat analisa terhadap litar serta membina aturcara kepada projek yang dihasilkan. Kertas ini boleh dijadikan sebagai sumber rujukan untuk kajian dan kerja-kerja penyelidikan bagi pelajar-pelajar kejuruteraan elektrik yang membuat projek akhir yang menggunakan modul sensor.

Keywords: *Pengujian; Modul Sensor; Multimeter; Jadual Kebenaran; Pseudokod*

PENGENALAN

Penggunaan sensor sememangnya banyak diaplikasikan di dalam semua bidang di dalam kehidupan seharian kita. Penggunaan tidak hanya terhad pada peralatan di rumah sahaja malah sehingga ke sektor perubatan, industri, hiburan, pengangkutan, ketenteraan dan pertanian. Ini menunjukkan besar dan pentingnya penggunaan sensor di dalam teknologi masa kini. Oleh itu, pengetahuan berkaitan sensor seperti jenis-jenis, fungsi dan penyelesaian masalah berkaitan sensor adalah sangat perlu difahami.

Merujuk pada mana-mana laman sesawang projek elektronik, kebanyakan projek elektronik yang dihasilkan adalah menggunakan sensor sebagai masukan kepada projek. Di antara senarai projek yang dicadangkan oleh penulis blog dan menjadi kebiasaan serta ikutan kepada pelajar-pelajar kejuruteraan elektrik adalah seperti mesin basuh tangan automatik, peti surat automatik dengan amaran buzzer, tabung elektronik dengan penggera, pengesan kebakaran dengan amaran buzzer dan paparan LCD, pengesan kebocoran gas dengan pengaktifan sistem pengudaraan selamat, pengesan banjir, ampaian baju pintar dengan amaran

SMS dan banyak lagi. Menurut Sameer Kadam (2014) reka bentuk sesuatu pemilihan komponen reka bentuk peranti elektronik dan prestasinya adalah bergantung kepada pilihan yang paling berkesan dan kos komponen yang rendah. Pemilihan komponen yang sesuai untuk sesuatu tertentu projek adalah bergantung pada harga, ketersediaan dan penyeragaman, sebagai tambahan kepada keperluan teknikal. Hanya beberapa komponen yang dijangka akan menjadi komponen tujuan khas.

Di dalam penghasilan sesuatu projek elektronik, perkara pertama yang harus diketahui ialah bagaimana komponen tersebut berfungsi atau beroperasi. Kemudian komponen tersebut perlulah diuji berdasarkan kepada fungsi atau penggunaannya. Pengujian komponen adalah satu-satunya cara untuk memastikan projek yang dihasilkan tidak menggunakan komponen yang rosak seterusnya dapat mengurangkan kerosakan semasa proses penghasilan litar projek. Terdapat pelbagai bentuk instrumen ujian yang boleh digunakan untuk menguji peralatan elektronik seperti osiloskop, penjana isyarat, penganalisis spektrum, penganalisis logik dan banyak lagi. Namun, multimeter adalah salah satu yang paling biasa digunakan. Menurut Tim (2015), satu cara mudah untuk mengetahui masalah ialah dengan menggunakan multimeter untuk menguji sensor. Apabila pengujian dilakukan, hendaklah dipastikan voltan yang diukur pada sensor berada dalam julat yang telah ditetapkan di dalam manual pengguna. Sekiranya voltan yang diukur adalah dalam julat yang telah ditetapkan, maka sumber voltan adalah bukan masalah utama.

Objektif kertas kerja ini adalah untuk menguji modul sensor dengan menggunakan multimeter dan membina jadual kebenaran bagi menghasilkan pseudokod. Pengujian hanya melibatkan beberapa jenis modul sensor yang biasa digunakan oleh pelajar dalam menghasilkan projek. Pengujian adalah secara pemerhatian terhadap status persekitaran dan status LED pada modul sensor, serta pengukuran nilai voltan menggunakan multimeter pada pin DO.

KAJIAN LITERATUR

Sensor adalah asas utama dalam penciptaan dan aplikasi untuk mengawal serta memantau suatu sistem kawalan. Terdapat banyak kajian yang dilakukan berkaitan projek yang telah dihasilkan menggunakan sensor sebagai komponen utama. Siti Musyriyah dan Mohad Anizu (2006) telah membuat kajian menggunakan sensor dalam menentukan kesalahan lompatan acara lompat jauh. Sensor jenis infrared yang digunakan telah diletakkan pada papan lonjak acara lompat jauh bagi melihat keberkesanan menentukan kesalahan lompatan acara lompat jauh. Kajian lain oleh Shihabudin dan Safrina (2016) juga menggunakan teknologi sensor bagi kajian yang dihasilkan iaitu sistem pemantauan tempat letak kereta dengan menggunakan sensor ultrasonic dan Arduino bagi membantu kerja pemantauan oleh para pekerja tempat letak kereta. Kajian berkaitan aplikasi penggunaan sensor oleh Muhammad Heksarialdi (2021) pula ialah Prototaip Radar Serangan Pengesanan Sasaran Berasaskan Penderia Ultrasonik. Sistem radar pengesanan sasaran atau objek sekeliling yang dihasilkan adalah menggunakan sensor ultrasonik. Objek yang dikesan akan menghidupkan buzzer sebagai amaran dan menggerakkan servo motor bagi menarik picu busur dan melepaskan anak panah. Kajian terkini oleh Muhammad Hafizzurrahman (2022) iaitu pengawalan arah tembakan bola pada robot pelontar bola tenis menggunakan sensor ultrasonic. Robot pelontar membekalkan bola secara berturut-turut dengan pelbagai kelajuan, putaran, dan arah pukulan kepada pemain yang berlatih. Oleh itu, memahami parameter sangat penting dalam merancang serta menguji sistem kawalan yang menggunakan sensor.

Modul Sensor

Sensor adalah peranti elektronik yang mengesan perubahan keadaan persekitaran seperti perubahan suhu, tekanan, cahaya, bunyi dan sebagainya. Sensor akan bertindak balas kepada input daripada persekitaran seperti keamatan cahaya atau suhu dan menukar kuantiti fizikal tersebut kepada kuantiti elektrik. Terdapat pelbagai jenis sensor yang biasa digunakan di dalam penghasilan projek seperti sensor cahaya, sensor pergerakan, sensor suhu, sensor kelembapan, sensor objek, sensor gas, sensor api dan banyak lagi.

Bagi projek yang menggunakan pengawal mikro seperti Arduino UNO, ESP32 atau Raspberry Pi, penggunaan modul sensor adalah lebih mudah kerana sensor telahpun diletakkan bersama dengan litar elektronik tambahan yang lain. Modul sensor biasanya terdiri daripada 4 pin iaitu VCC, GND, AO dan DO, namun ada juga modul sensor ini yang terdiri daripada 3 pin iaitu VCC, GND dan S/OUT/DO. Jadual 1 adalah perincian atau fungsi pin-pin dan spesifikasi asas bagi modul-modul ini.

Jadual 1. Jadual Pin dan Spesifikasi Modul Sensor

		Penerangan
Nama Pin	VCC	sambung pada 3.3V to 5V DC
	GND	sambung pada GND
	AO / S (Signal)	Keluaran Isyarat Analog
	DO / OUT	Keluaran Isyarat Digital
Ciri-ciri dan Spesifikasi	Voltage Operasi	3.3V - 5V DC
	Arus Operasi	15ma
	Keluaran Digital	0V - 5V Tinggi - Keadaan persekitaran/sekeliling mencapai tahap yang ditetapkan Rendah - Keadaan persekitaran/sekeliling tidak mencapai tahap yang ditetapkan
	Keluaran Analog	0V - 5V berubah-ubah berdasarkan kepada perubahan persekitaran/sekeliling
	LED	Penunjuk

Penetapan isyarat logik bagi voltan adalah untuk mengeluarkan hanya dua jenis isyarat iaitu tinggi dan rendah sebagaimana yang ditunjukkan pada Jadual 2. Voltan bekalan kuasa penuh adalah untuk keadaan tinggi atau 1 dan voltan sifar untuk keadaan rendah atau 0. Voltan isyarat masukan adalah berkisar dari 0 volt hingga 0.8 volt untuk keadaan logik rendah dan 2 volt hingga 5 volt untuk keadaan logik tinggi. Manakala, voltan isyarat keluaran adalah berkisar dari 0 volt ke 0.5 volt untuk keadaan logik rendah, dan 2.7 volt hingga 5 volt untuk keadaan logik tinggi (*Logic Signal Voltage Levels*, 2004).

Jadual 2. Tahap Voltan Isyarat Logik

	Tahap Voltan	Isyarat Logik
Isyarat Masukan	0 - 0.8 volt	Rendah (0)
	2 - 5 volt	Tinggi (1)
Isyarat Keluaran	0 - 0.5 volt	Rendah (0)
	2.7 - 5 volt	Tinggi (1)

Modul Sensor Cahaya (LDR)

Modul sensor LDR seperti yang ditunjukkan pada Rajah 1 digunakan untuk mengesan perubahan keamatan cahaya dan intensiti cahaya persekitaran dengan menggunakan IC pembanding LM393. Modul ini menghasilkan isyarat analog dan digital, yang dapat digunakan untuk memicu modul lain dengan jenis keluaran analog (AO) dan keluaran digital 0 dan 1 (DO). Sensitiviti LDR terhadap cahaya boleh dilaras pada tombol potensiometer yang terdapat pada modul (Gain, 2016).

Apabila keamatan cahaya meningkat pada permukaan LDR maka rintangan LDR berkurangan. Jumlah maksimum voltan akan diperuntukkan merentasi perintang $10\text{K}\Omega$ (R3). Jadi, jumlah voltan yang rendah daripada LDR diberikan kepada masukan songsang (*inverting*) pada pin 2 IC. IC pembanding membandingkan voltan ini dengan voltan ambang. Dalam keadaan ini, voltan masukan adalah kurang daripada voltan ambang, jadi keluaran sensor menjadi rendah (0). Sebaliknya, apabila keamatan cahaya berkurangan atau gelap pada permukaan LDR maka rintangan LDR meningkat. Kemudian, jumlah voltan maksimum akan diperuntukkan merentasi LDR (R2). Oleh itu, jumlah voltan yang tinggi daripada LDR diberikan kepada masukan songsang pada pin 2 IC. Seterusnya, IC pembanding membandingkan voltan ini dengan voltan ambang. Dalam keadaan ini, voltan masukan adalah lebih besar daripada voltan ambang, jadi keluaran sensor menjadi tinggi (1) (*LDR sensor module*, 2020).

Rajah 1. Modul Sensor Cahaya (LDR)

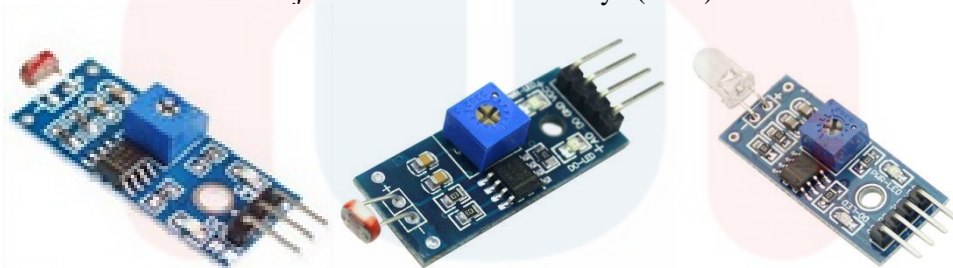

Modul Sensor Api

Rajah 2. Modul Sensor Api



Rajah 2 ialah modul sensor api yang digunakan untuk mengesan cahaya inframerah yang dipancarkan oleh api. Keluaran sensor ini ialah isyarat analog atau isyarat digital dan potensiometer digunakan untuk melaraskan kepekaan. Apabila sensor ini mengesan api nyalaan dalam julat 760 nm – 1100 nm panjang gelombang, maka rintangan phototransistor berkurangan. Jumlah maksimum voltan akan diperuntukkan merentasi Perintang $10\text{K}\Omega$ (R2). Jadi, jumlah voltan yang rendah daripada phototransistor diberikan kepada masukan songsang pada pin 2 IC. IC pembanding akan membandingkan voltan ini dengan voltan ambang. Di dalam keadaan ini, voltan masukan adalah kurang daripada voltan ambang, jadi keluaran sensor menjadi rendah (0). Sebaliknya, apabila modul ini tidak mengesan api nyalaan maka rintangan phototransistor adalah tinggi. Jumlah voltan maksimum akan diperuntukkan merentasi

phototransistor. Jumlah voltan yang tinggi daripada phototransistor diberikan kepada masukan songsang pada pin 2 IC. IC pembedaan akan membandingkan voltan ini dengan voltan ambang. Di dalam keadaan ini, voltan masukan lebih besar daripada voltan ambang, jadi keluaran sensor menjadi tinggi (1) (*IR Infrared Flame Sensor Module*, 2020).

Modul Sensor Inframerah

Rajah 3. Modul Sensor Inframerah



Rajah 3 ialah modul sensor inframerah (IR), modul ini mempunyai sepasang pemancar dan penerima inframerah. Sensor IR akan memancarkan sinar infra merah melalui diod pemancar infra merah dan diterima oleh diod photo. Jika terdapat objek pada persekitaran, maka frekuensi inframerah yang dipancarkan akan melantun dari permukaan objek dan isyarat akan diterima oleh diod photo. Setelah diproses oleh rangkaian pembedaan LM393, LED hijau akan menyala dan mengeluarkan isyarat keluaran digital rendah (0). Sekiranya, penerima infra merah tidak mengesan sebarang objek. Pada keadaan ini, LED penunjuk tidak menyala dan isyarat keluaran digital adalah tinggi (1) (*IR Sensor Module*, 2020).

Modul Sensor Garisan

Rajah 4. Modul Sensor Garisan

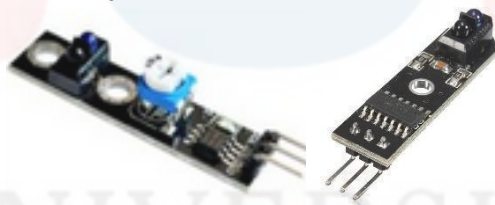

Sensor garisan seperti yang ditunjukkan dalam Rajah 4 dapat mengesan kehadiran garis hitam dengan memancarkan cahaya inframerah (IR) dan mengesan tahap cahaya yang kembali semula kepada sensor berkaitan. Di bahagian atas modul terdapat dua komponen yang kelihatan seperti LED dimana biru ialah pemancar cahaya IR dan hitam ialah penerima cahaya yang dipantulkan. Modul ini juga mempunyai komponen yang dipanggil potensiometer bagi melaraskan peranti. Sesetengah sensor ini mempunyai dua jenis keluaran iaitu analog dan digital. Keluaran analog akan menghasilkan bacaan berterusan tahap cahaya yang dikesan oleh sensor. Keluaran digital pula terhasil daripada perbandingan aras cahaya dengan aras ambang yang dilaraskan dengan memutar potensiometer. Jika sensor tidak menerima cahaya yang mencukupi untuk melepasi nilai ambang, keluaran digital akan menjadi tinggi (1). Jika cahaya yang mencukupi diterima dan melebihi nilai ambang jadi keluaran akan ditetapkan kepada rendah (0). Modul ini direka dengan beranggapan untuk mengesan garis hitam. Garis hitam tidak akan memantulkan cahaya sebanyak mana, jadi keluaran akan ditetapkan kepada tinggi (1) apabila permukaan hitam berada di bawahnya (*Line sensors and how to use them*, n.d).

Pseudokod

Pseudokod ialah bahasa tidak formal yang digunakan untuk membantu membangunkan aturcara atau algoritma yang terperinci berasaskan teks. Ia bukan bahasa pengaturcaraan sebenar, jadi ia tidak boleh dikompilasi ke dalam program boleh laku, oleh itu pengisytiharan data tidak diperlukan di dalam penghasilan pseudokod. Menurut McConnell, 2004, pseudokod secara amnya tidak mematuhi peraturan sintaks mana-mana bahasa tertentu dan tiada bentuk piawai yang sistematik.

Pseudokod digunakan untuk membuat deraf kasar atau ringkasan aliran aturcara program yang tidak termasuk butiran asas program. Ia bertujuan untuk bacaan dan kefahaman manusia sahaja dan bukannya bacaan mesin atau kod bahasa pengaturcaraan konvensional. Ia digunakan untuk mencipta pernyataan bagi mencapai hasil yang diperlukan sebelum ditukarkan kepada bahasa pengaturcaraan tertentu. Penulisan pseudokod adalah untuk memastikan pengaturcara memahami sepenuhnya keperluan perisian projek sebelum menghasilkan aturcara dan menyelaraskan kod yang digunakan dengan sewajarnya.

METODOLOGI

Kertas kajian ini bertujuan untuk menunjukkan kaedah paling mudah dalam menguji modul sensor iaitu hanya dengan menggunakan multimeter. Pengujian yang dijalankan hanya melibatkan beberapa jenis modul sensor yang kebiasaannya digunakan oleh pelajar dalam menghasilkan projek. Penyambungan ke semua modul sensor yang diukur adalah seperti yang ditunjukkan pada Rajah 5.

Rajah 5. Cara Penyambungan Modul Sensor LDR ke Multimeter

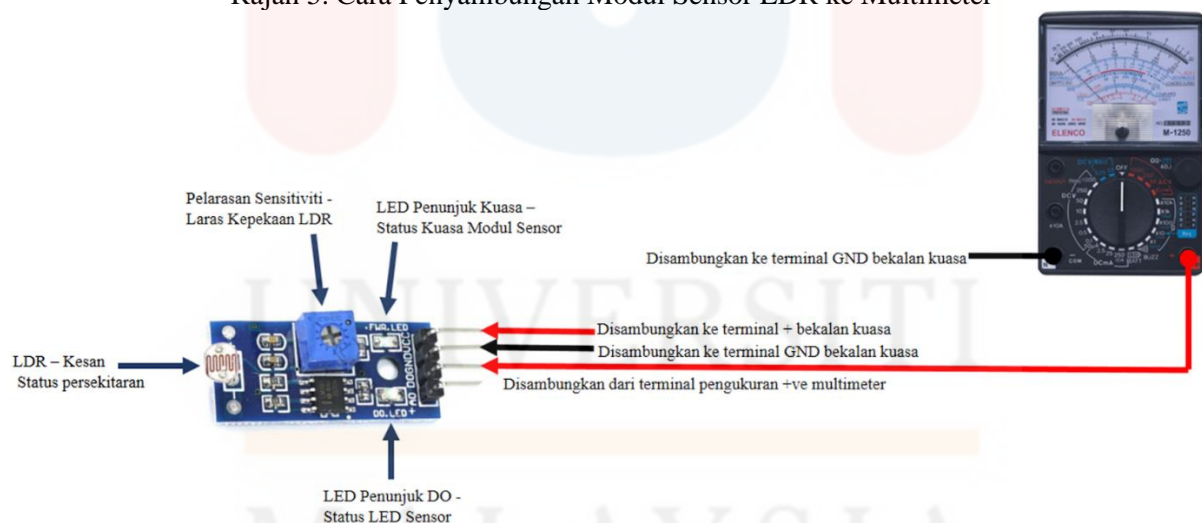

Keputusan pengujian modul sensor yang dicatatkan adalah berpandukan pemerhatian terhadap status persekitaran, status LED pada modul sensor, nilai voltan yang diukur dengan menggunakan multimeter pada pin DO. Penentuan status digital bagi nilai voltan yang diukur adalah berpandukan tahap voltan dan keadaan logik seperti yang ditunjukkan pada Jadual 2. Jadual kebenaran operasi projek dihasilkan dengan merujuk pada status sensor seterusnya menghasilkan pseudokod.

KEPUTUSAN DAN ANALISA

Pengujian voltan pada pin DO telah dilakukan sebanyak 4 kali bagi setiap sensor yang telah dipilih. Jadual 3 menunjukkan keputusan pengujian yang telah dilakukan bagi mentafsir voltan isyarat yang terletak di antara julat voltan bekalan penuh dan sifar. Keputusan menunjukkan tahap voltan yang diukur adalah berbeza-beza disebabkan oleh penurunan voltan dalam litar. Keputusan pengujian juga menunjukkan tahap voltan isyarat masukan yang diukur berada dalam julat voltan yang telah ditetapkan iaitu dalam julat voltan 0 hingga 0.8 volt untuk keadaan logik rendah dan 2 volt hingga 5 volt untuk keadaan logik tinggi seperti yang ditunjukkan pada Jadual 2. Status persekitaran dan status LED sensor menunjukkan ke semua sensor beroperasi di dalam keadaan aktif rendah (0).

Jadual 3. Keputusan Pengujian Sensor

Jenis Sensor	Status Persekitaran	Status LED Sensor	Pengukuran Nilai Voltan DO Sensor			
			1x	2x	3x	4x
Sensor Cahaya	Ada Cahaya	Menyala	0.0v	0.0v	0.0v	0.2v
	Tiada Cahaya	Tidak Menyala	4.7v	5.3v	4.8v	4.6v
Sensor Api	Ada Api	Menyala	0.4v	0.4v	0.2v	0.4v
	Tiada Api	Tidak Menyala	4.6v	5.3v	4.8v	4.6v
Sensor Inframerah	Ada Objek	Menyala	0.3v	0.2v	0.2v	0.2v
	Tiada Objek	Tidak Menyala	4.7v	5.2v	4.8v	4.6v
Sensor Garisan	Putih	Menyala	0.3v	0.4v	0.5v	0.4v
	Hitam	Tidak Menyala	4.6v	5.0v	4.8v	4.8v

Jadual 4 adalah penetapan status digital sensor berpandukan julat voltan yang diukur pada Jadual 3 berbanding isyarat logik pada Jadual 2. Didapati keputusan penetapan status digital berbanding isyarat logik pada Jadual 2 adalah menepati teori operasi bagi semua sensor yang telah dibincangkan pada bahagian kajian literatur. Status digital sama ada logik 1 atau 0 ini adalah sebagai penentuan kepada status digital sensor yang digunakan dan boleh digunapakai di dalam penyediaan pseudokod yang dihasilkan.

Jadual 4. Penentuan Status Digital Sensor

Jenis Sensor	Julat Pengukuran Nilai Voltan VO Sensor	Status Digital
Sensor Cahaya	0.0v - 0.2v	Rendah (0)
	4.6v - 5.3v	Tinggi (1)
Sensor Api	0.2v - 0.4v	Rendah (0)
	4.6v - 5.3v	Tinggi (1)
Sensor Inframerah	0.2v - 0.3v	Rendah (0)
	4.6v - 5.2v	Tinggi (1)
Sensor Garisan	0.3v - 0.5v	Rendah (0)
	4.6v - 5.0v	Tinggi (1)

Jadual 5 adalah jadual kebenaran projek yang menggunakan pengawal mikro ESP32 bagi mengawal 1 masukan daripada sensor cahaya dan 2 keluaran LED. GPIO (*General Purpose Input Output*) ialah no pin masukan/keluaran pada ESP32 yang dicadangkan untuk disambungkan pada peranti bagi melihat aturcara yang setara berdasarkan pseudokod yang dihasilkan.

Jadual 5. Jadual Kebenaran 1 Masukan dan 2 Keluaran

Masukan		Keluaran			
Sensor Cahaya		LED 1		LED 2	
GPIO 15		GPIO 16		GPIO 17	
Persekitaran	Status Digital	Status LED	Status Digital	Status LED	Status Digital
Ada Cahaya	0	Menyala	1	Tidak Menyala	0
Tiada Cahaya	1	Tidak Menyala	0	Menyala	1

Berikut adalah pseudokod yang dihasilkan berdasarkan Jadual 5 dan aturcara yang setara.

Pseudokod

```

Jika Sensor Cahaya mengesan cahaya
Maka
    LED 1 menyala
    LED 2 tidak menyala
Jika Sensor Cahaya mengesan tiada cahaya
Maka
    LED 1 tidak menyala
    LED 2 menyala
    
```

Aturcara

```

If (digitalRead (15) == 0)
{
    digitalWrite (16, HIGH);
    digitalWrite (17, LOW);
}
If (digitalRead (15) == 1)
{
    digitalWrite (16, LOW);
    digitalWrite (17, HIGH);
}
    
```

Jadual 6 pula adalah jadual kebenaran bagi projek yang menggunakan 2 masukan dan 4 keluaran, juga dikawal menggunakan pengawal mikro ESP32. Masukan daripada 2 sensor garisan mengawal 2 keluaran motor (5vdc), buzzer dan LCD 16x2.

Jadual 6. Jadual Kebenaran 2 Masukan dan 3 Keluaran

Masukan		Keluaran						
Sensor Garisan 1	Sensor Garisan 2	Buzzer	LCD		Motor 1		Motor 2	
15	16	13	21 & 22		12	14	17	18
Status Digital	Status Digital	Status Digital	Paparan	(Jalur, Baris)	IN 1	IN 2	IN 3	IN 4
0	0	0	Motor Ke Hadapan	(0,1)	0	1	0	1
0	1	1	Motor Ke Kanan	(0,1)	0	1	0	0
1	0	1	Motor Ke Kiri	(0,1)	0	0	0	1
1	1	0	Motor Berhenti	(0,1)	0	0	0	0

Berikut adalah pseudokod yang dapat dihasilkan daripada Jadual 6 dan aturcara yang setara.

Pseudokod	Aturcara
Jika Kedua-dua Sensor Garisan mengesan warna putih Maka	<pre> If (digitalRead (15) == 0 && digitalRead (16) == 0) { digitalWrite(12, LOW); digitalWrite(14, HIGH); digitalWrite(17, LOW); digitalWrite(18, HIGH); lcd.setCursor(0,1); lcd.print("MOTOR ke hadapan"); digitalWrite (13, LOW); } </pre>
MOTOR bergerak ke hadapan LCD papar teks "MOTOR ke hadapan" pada (0,1) BUZZER tidak berbunyi	
Jika Sensor Garisan 1 mengesan warna putih dan Sensor Garisan 2 mengesan warna hitam Maka	<pre> If (digitalRead (15) == 0 && digitalRead (16) == 1) { digitalWrite(12, LOW); digitalWrite(14, HIGH); digitalWrite(17, LOW); digitalWrite(18, LOW); lcd.setCursor(0,1); lcd.print("MOTOR ke kanan"); digitalWrite (13, HIGH); } </pre>
MOTOR bergerak ke kanan LCD papar teks "MOTOR ke kanan" pada (0,1) BUZZER berbunyi	
Jika Sensor Garisan 1 mengesan warna hitam dan Sensor Garisan 2 mengesan warna putih Maka	<pre> If (digitalRead (15) == 1 && digitalRead (16) == 0) { digitalWrite(12, LOW); digitalWrite(14, LOW); digitalWrite(17, LOW); digitalWrite(18, HIGH); lcd.setCursor(0,1); lcd.print("MOTOR ke kiri"); digitalWrite (13, HIGH); } </pre>
MOTOR bergerak ke kiri LCD papar teks "MOTOR ke kiri" pada (0,1) BUZZER berbunyi	
Jika Kedua-dua Sensor Garisan mengesan warna hitam Maka	<pre> If (digitalRead (15) == 1 && digitalRead (16) == 1) { digitalWrite(12, LOW); digitalWrite(14, LOW); digitalWrite(17, LOW); digitalWrite(18, LOW); lcd.setCursor(0,1); lcd.print("Motor Berhenti"); digitalWrite (13, LOW); } </pre>
MOTOR berhenti berputar LCD papar teks "Motor Berhenti" pada (0,1) BUZZER tidak berbunyi	

Merujuk kepada pseudokod yang telah dihasilkan daripada jadual kebenaran 5 dan 6, jelas menunjukkan bahawa pseudokod adalah set arahan yang mengikut aturan langkah. Set arahan ini hanya menggunakan ayat pertuturan dalam melaksanakan sesuatu tugas dari mula hingga akhir. Langkah-langkah arahan tugas inilah yang memudahkan kerja pengaturcara untuk menterjemahkannya ke dalam bahasa arahan aturcara yang sepadan.

KESIMPULAN

Modul sensor adalah litar elektronik tambahan yang dipasang bersama dengan sensor atau penerima. Ia ialah peranti elektronik yang digunakan untuk mengesan dan bertindak balas kepada beberapa jenis masukan daripada persekitaran fizikal. Ciri-ciri dan spesifikasi voltan operasi dan status digital setiap modul sensor sebenarnya boleh terus dirujuk daripada helaian data, namun ia juga boleh ditentukan secara pengukuran menggunakan multimeter. Kertas kajian ini telah menguji 4 module sensor dengan menggunakan multimeter dan membina 2 jadual kebenaran bagi menghasilkan pseudokod seterusnya dibandingkan dengan aturcara yang setara.

Kertas kajian ini diharapkan dapat dijadikan sebagai sumber rujukan kepada pelajar-pelajar kejuruteraan elektrik terutamanya dalam melaksanakan projek akhir. Kaedah pengukuran modul menggunakan multimeter yang ditunjukkan boleh diaplikasikan kepada mana-mana modul untuk mengukur nilai voltan pada pin DO bagi penetapan status digital komponen berkaitan. Jadual kebenaran dapat dihasilkan dengan mudah berpandukan status digital yang telah ditetapkan. Seterusnya, pseudokod atau langkah kerja yang tidak formal dan lebih berasaskan kepada teks boleh dihasilkan bagi membantu pelajar memahami cara sesuatu projek beroperasi. Akhirnya aturcara projek yang dibangunkan adalah lebih jelas dan tersusun.

RUJUKAN

- McConnell, S. (2004). *Code Complete, 2nd Edition*, Wiley India Pvt. Limited ISBN 9350041243, 9789350041246
- Pickering, M. (2016). *How to Use a Multimeter*, Lulu Press, Inc. ISBN 1326742337, 9781326742331
- Han, N.Z & Tin, T.H. (2018). Design and Implementation of Flame Sensor and Obstacle Detection for Automatic Fire Fighting Robots. *International Journal of Scientific Engineering and Technology Research*, ISSN 2319-8885 Vol.07, Issue.02, 0262-0266.
- Gain, H., Patch, C. & Filter, A. (2016). High Gain Circular Patch Antenna Filter. *The International Journal of Science & Technology*. Vol. 4, no. 11, 50–53.
- Muhammad Heksarialdi Muhajir, Rini Handayani S.T., M.T. Marlindia Ike Sari S.T., M.T. (2021). Purwarupa Radar Pendeteksian Dan Penyerangan Target Berbasis Sensor Ultrasonik. *e-Proceeding of Applied Science* (Vol.7, No.2, pp 154). ISSN: 2442-5826
- Shihabudin Achmad Muhajir, A.K & Safrina Amini (2016). Sistem Monitoring Tempat Parkir dengan Sensor Ultrasonik Berbasis Arduino Uno Pada Cibinong City Mall. *Seminar Nasional Inovasi dan Aplikasi Teknologi Di Industri (Seniati)*. Program Studi Teknik Informatika Universitas Budi Luhur Jakarta Selatan. ISSN : 2085-4218
- Siti Musyriyah Mohd Nor & Mohad Anizu Ismail (2006). *Penggunaan Sensor Dalam Menentukan Kesalahan Melonjak Acara Lompat Jauh*. (Bachelor's thesis). Universiti Teknologi Malaysia.
- [Ahmad Wahyudi](#). (2018). *Cara Kerja Modul Infrared FC-51 Sensor Infra Merah*. Diambil pada September 11, 2022 daripada <https://www.tptumetro.com/>

- Dickson, K. (2020). *Pengertian Sensor dan Jenis-jenis Sensor*. Diambil pada September 11, 2022 daripada <https://teknikelektronika.com/>
- Nanisk Abdullah. (2018). *Unit 2: Algoritma, Pseudokod dan Carta Alir*. Diambil pada September 11, 2022 daripada <https://naniskabdullah.wordpress.com/>
- Tim, O. (2015). *How To Use A Multimeter to Troubleshoot Your Sensor*. Diambil pada September 11, 2022 daripada <https://www.apgsensors.com/>
- Tim, Y. (2015). *Reading Sensors with an Arduino*. Diambil pada September 11, 2022 daripada <https://www.allaboutcircuits.com/>
- Yogabayu. (n.d). *Arduino #11: Sensor Cahaya (Pengertian dan Jenis-jenis)*. Diambil pada September 11, 2022 daripada <https://dosenit.com/machine-learning/>
- LDR sensor module How LDR Sensor Works*. (2020, June 17). Diambil daripada <https://www.electroduino.com/ldr-sensor-module-how-ldr-sensor-works/>
- IR Infrared Flame Sensor Module How Fire Sensor Works*. (2020, June 18). Diambil daripada <https://www.electroduino.com/ir-infrared-flame-sensor-module/>
- IR Sensor Module How IR Sensor Module Works*. (2020, June 8). Diambil daripada <https://www.electroduino.com/what-is-ir-sensor-module-how-ir-sensor-module-works/>
- Lessons in Electric Circuits Vol. IV - Digital : Logic Signal Voltage Levels*. (2004) Diambil daripada <https://www.allaboutcircuits.com/textbook/digital/chpt-3/logic-signal-voltage-levels/>
- Line sensors and how to use them*. (n.d). Diambil daripada <https://www.futurelearn.com/info/courses/robotics-with-raspberry-pi/0/steps/75899>

Penilaian Terhadap Garis Panduan Bagi Emansipasi Wanita Menurut Ulama Melayu Abad ke-20

Nor Aniza Azeri
Universiti Sains Islam Malaysia
anizaazeri@gmail.com

Nur Saadah Hamisan@ Khair
Universiti Sains Islam Malaysia
saadahkhair@usim.edu.my

ABSTRACT

Women's emancipation is a process to liberate women based on Islamic principles from various forms of discrimination, illiteracy, and conventional customs that restrict the role of women in specific professions. The idea of women's emancipation has been addressed generally for centuries, notably by Malay scholars in the 20th century in order to preserve the rights of women who are frequently viewed as 'second class'. Therefore, this study was conducted to provide guidelines for women's emancipation by the Malay scholars to empower Malay women, so that, it can be referenced by all eras and generations. These guidelines were developed using a qualitative study's data collection process, which included document analysis and observation. Subsequently, these guidelines are examined and verified by a group of experts, including Malaysian academics and governmental agencies. The findings of this study will offer recommendations for overcoming the obstacles that prohibit women from being empowered and participating in aspects of knowledge and education, aspects of socioeconomics, and aspects of balancing family and career.

Keywords: *Women's emancipation; Guideline; Women's empowerment; Malay scholars.*

ABSTRAK

Emansipasi wanita ialah satu proses untuk membebaskan wanita berlandaskan prinsip-prinsip Islam daripada sebarang diskriminasi, buta huruf dan amalan tradisional yang membataskan peranan wanita di dalam bidang yang tertentu sahaja. Konsep bagi emansipasi wanita ini telah dibincangkan secara umum sejak berabad dahulu termasuklah oleh ulama Melayu pada abad ke-20 dalam bentuk karya dan penulisan untuk mempertahankan hak wanita yang sering dipandang sebagai 'kelas kedua'. Oleh itu, kajian ini dijalankan bagi menyediakan garis panduan terhadap emansipasi wanita menurut ulama Melayu untuk memperkasakan wanita Melayu agar boleh dirujuk oleh semua generasi merentasi zaman. Metodologi yang digunakan dalam membangunkan garis panduan ini ialah kajian kualitatif yang menggunakan analisis dokumen dan observasi sebagai metode pengumpulan data. Seterusnya, garis panduan ini dinilai dan divalidasi oleh beberapa pakar yang terdiri daripada ahli akademik dan agensi kerajaan di Malaysia. Hasil kajian ini akan menyediakan garis panduan yang menawarkan solusi dalam menyelesaikan cabaran-cabaran yang menghalang pemerksaan dan penglibatan wanita dalam aspek ilmu dan pendidikan, aspek sosio-ekonomi dan aspek keseimbangan keluarga dan kerjaya.

Kata kunci: *Emansipasi wanita; Garis panduan; Permerksaan wanita; Ulama Melayu.*

PENDAHULUAN

Perjuangan emansipasi wanita adalah satu bentuk perjuangan universal untuk semua wanita di seluruh dunia bagi menentang apa sahaja bentuk diskriminasi, berat sebelah, dan ketidakadilan yang bercanggah dengan undang-undang agama dan moral terhadap kaum wanita. Isu

emansipasi wanita ini hakikatnya telah diperkenalkan sejak kedatangan Islam yang membawa misi untuk membebaskan wanita daripada tradisi Jahiliyyah yang memandang hina terhadap kaum wanita (Nur Saadah, 2020). Rasulullah SAW membawa satu perubahan besar terhadap status wanita dengan mengangkat martabat dan memperjuangkan hak-hak wanita.

Di dalam konteks wanita Melayu, perjuangan emansipasi wanita ini mendapat pendekatan secara tidak langsung dalam pelbagai bentuk. Antaranya adalah melalui penulisan yang sebenarnya memberi pengaruh yang besar dalam memperbaiki kehidupan bermasyarakat yang harmoni antara kaum lelaki dan juga wanita. Karya ulama Melayu adalah antara usaha dalam memperkenalkan emansipasi wanita dalam kalangan masyarakat Melayu sama ada secara langsung mahupun tidak langsung. Mereka menekankan bahawa wanita mempunyai kuasa dalam bidang peribadi mereka iaitu pengurusan rumah, tetapi pada masa yang sama mereka perlu dididik untuk memiliki kuasa dalam ruang awam. Syed Syeikh Ahmad al-Hadi misalnya, menegaskan bahawa tugas wanita bukan semata-mata untuk melahirkan dan menjaga anak-anak mereka, tetapi untuk menentukan kemajuan negara (*Al-Ikhwān*, Mei 1927; *Al-Ikhwān*, Oktober 1930).

Pelbagai faktor yang menyumbang kepada perjuangan emansipasi wanita di Tanah Melayu Antaranya adalah untuk mendapatkan hak yang sepatutnya diberikan kepada wanita Melayu seperti hak pendidikan. Di bawah penjajahan Barat, majoriti wanita mendapatkan pendidikan rendah dan tinggi adalah dalam kalangan elit Melayu dan kaum Cina, manakala jumlah wanita bagi kaum Melayu dari pendalaman dan kaum India adalah sedikit. Selain itu, banyak sekolah telah ditakluki oleh British, maka kaum Melayu mempunyai prejudis untuk menghantar anak-anak mereka kerana beberapa faktor; sekolah itu menjadi tempat penyebaran agama Kristian; percampuran bebas jantina; ibu bapa kehilangan bantuan rumah tangga; dan isu persekolahan yang amat asing dalam kalangan orang Melayu (Mahani Musa, 2010). Namun begitu, selepas kemerdekaan, kesedaran untuk mendapat pendidikan mula bertambah baik. Orang Melayu mula percaya bahawa pendidikan adalah faktor utama untuk membebaskan wanita daripada ditindas dan didiskriminasi.

ADVOKASI TERHADAP EMANSIPASI WANITA DI MALAYSIA

Di dalam konteks yang sama, perjuangan emansipasi wanita yang ditekan oleh para ulama Melayu adalah suatu bentuk untuk memperkasakan kaum wanita Melayu. Pemerksaan wanita sangat penting kerana wanita berperanan penting dalam pembentukan sebuah keluarga dan menjadi tunjang kemajuan bagi sesebuah negara. Menurut Sabina dan Shaikh Shamim (2010), pemerksaan wanita boleh ditakrifkan sebagai peningkatan kawalan wanita terhadap kehidupan dan pilihannya sendiri dari segi kewangan, pengetahuan, maklumat, kemahiran, kuasa politik dan sumber ekonomi. Debnath et al. (2019) juga telah menyebut bahawa pemerksaan wanita tertumpu kepada pemprosesan meningkatkan status pendidikan, ekonomi, budaya dan politik wanita dalam masyarakat yang secara tradisinya ditindas dan diabaikan.

Walaupun kini pada era kemajuan, namun masih berlaku diskriminasi terhadap wanita. Sebagai contoh, 56% wanita Malaysia menghadapi diskriminasi dalam kerjaya mereka kerana jantina mereka. Diskriminasi boleh dalam pelbagai bentuk sama ada dengan mempersoalkan atau mengkritik status perkahwinan mereka atau dengan memandang rendah kelayakan mereka yang lebih rendah, atau dengan meminta permintaan kecil yang tidak termasuk dalam skop kerja mereka seperti membuat kopi dan menyediakan makanan ringan. (Pertubuhan Bantuan Wanita (WAO), 2020). Tambahan pula, menurut Robinson (2021), beliau mendapati bahawa kakitangan hospital perubatan wanita sentiasa mengalami diskriminasi berasaskan jantina dan

gangguan seksual. Antara 18 institusi yang ditinjau, laporan biasa yang diterima daripada wanita termasuk kes sentuhan, kenyataan seksual, gerak isyarat dan rupa yang tidak sesuai. Doktor wanita juga mendakwa bahawa jantina mereka mempunyai kesan buruk terhadap kemungkinan pekerjaan mereka lebih daripada doktor lelaki.

Oleh demikian, advokasi bagi emansipasi dan pemerksaan wanita di Malaysia perlu selari dengan konteks dan amalan yang dipraktikkan oleh masyarakat setempat. Wanita perlu mendapat pendidikan yang baik dan peluang untuk membuat pilihannya sendiri, tetapi dalam masa yang sama, wanita masih perlu mengambil kira aspek agama, sosial dan budaya dalam menjalankan hak dan tanggungjawab mereka.

Islam adalah agama yang menangani hak wanita dengan memberikan mereka hak yang sepatutnya, dan maruah serta status mereka sebagai ibu dan isteri. Semua ini telah ditegaskan oleh ulama Melayu berdasarkan dalil yang terdapat dalam al-Quran dan sunnah, bahawa kedua-duanya merupakan sumber utama dalam Islam. Oleh itu, garis panduan yang dikemukakan dalam kajian ini diperolehi melalui usaha yang telah ditekankan dalam penulisan ulama Melayu.

Garis panduan yang dihasilkan adalah bagi mencapai tiga tujuan penting. Pertama, untuk menghapuskan diskriminasi terhadap wanita yang masih berlaku sehingga kini dalam pelbagai aspek seperti pendidikan, politik, ekonomi, masyarakat, budaya, sivil atau mana-mana bidang lain. Kedua, untuk membantu wanita dalam mengiktiraf hak mereka berdasarkan perspektif Islam, dan pada masa yang sama menyediakan platform yang sesuai untuk para wanita menuntut hak mereka. Mereka boleh merujuk kepada tulisan ulama Melayu yang masih ada sehingga kini. Ketiga, untuk mewujudkan hubungan yang harmoni di antara kaum lelaki dan wanita kerana kedua-duanya diciptakan untuk saling melengkapi dan menghormati antara satu sama lain.

METODOLOGI

Tujuan utama kajian ini adalah untuk menilai garis panduan bagi emansipasi wanita yang terdapat dalam penulis ulama Melayu abad ke-20. Kajian ini memfokuskan kepada analisis kandungan sebagai sumber utama pengumpulan data. Analisis kandungan atau dikenali sebagai content analysis merujuk kepada kaedah penyelidikan yang memusatkan perhatian kepada mesej dengan membuat pemerhatian sistematik terhadap kategori yang dipilih oleh pengkaji (Babbie, 2012). Ia juga adalah metodologi penelitian untuk memahami isi kandungan sesuatu bahan sama ada dalam bentuk teks, gambar, simbol atau data audio. Ia digunakan bagi menilai kandungannya untuk diukur konteks penggunaannya (Niels & Jacobs, 2017).

Berdasarkan metodologi ini, kajian menghasilkan garis panduan melalui tafsiran teks yang terkandung dalam lima buah karya ulama Melayu iaitu; (1) *Tafsir Nur al-Ihsan* karya Haji Muhammad Sa'id bin Umar (1845-1932); (2) *Kitab Alam Perempuan* ditulis oleh Syed Syeikh Ahmad al-Hadi (1867-1934); (3) *Risalah Seruan Kepada Jenis Yang Lembut Perempuan-Perempuan* oleh Abdullah Abdur-rahman (1876-1950); (4) *Kitab Adab Perempuan* dihasilkan oleh Ahmad bin Ya'qub (1891-1959; dan (5) *Bahr al-Madhi Sharh Mukhtasar Sahih al-Tirmizi* ditulis oleh Mohammed Idris Abdul Raof al-Marbawi (1896-1989). Buku-buku ini dipilih sebagai bahan utama dalam kajian ini kerana kandungannya meliputi tentang isu wanita sama ada secara langsung mahupun tidak langsung yang bersandarkan kepada dalil-dalil al-Quran dan Sunnah.

Seterusnya, garis panduan yang dibina dalam kajian ini dinilai dan divalidasi oleh tiga orang pakar yang terdiri daripada ahli akademik dan agensi kerajaan di Malaysia. Pemilihan pakar-pakar ini adalah berdasarkan kepakaran mereka dalam bidang kajian ini, seterusnya mereka juga merupakan antara individu yang berperanan penting dalam masyarakat, menjadi ahli jawatankuasa teknikal undang-undang syarak dan sivil dan juga turut berperanan sebagai panel hakim Mahkamah Syariah Negeri Sembilan dalam bidang tribunal kekeluargaan Islam.

Jadual 1: Senarai Pakar Penilai

Penilai	Jawatan	Bidang Pengajian	Pengalaman
Pakar A	Ahli Akademik	Ijazah Doktor Falsafah Pengajian Islam dalam bidang tafsir dan kajian fiqh al-Quran.	Merupakan pensyarah kanan dan panel hakim Mahkamah Syariah Negeri Sembilan dalam bidang tribunal kekeluargaan Islam.
Pakar B	Ahli Akademik	Ijazah Doktor Falsafah dalam bidang Pengajian Quran dan Sunnah.	Merupakan Professor Madya di Jabatan Quran dan Sunnah dan Timbalan Pengarah Masjid Sultan Haji Ahmad Shah.
Pakar C	Agensi Kerajaan	Ijazah Doktor Falsafah dalam bidang Federalisme.	Menjalankan penyelidikan berkaitan undang-undang awam, undang-undang Islam dan perpaduan sosial di Malaysia. Beliau juga terlibat dalam penggubalan dasar berkaitan wanita dan kanak-kanak.

Tiga bahagian soalan berkaitan garis panduan terhadap emansipasi wanita telah didedahkan kepada pakar penilai melalui emel bagi mendapat pengesahan dan penilaian. Tiga bahagian soalan itu meliputi; (1) definisi bagi konsep emansipasi wanita berdasarkan persepektif ulama Melayu; (2) bentuk-bentuk emansipasi wanita dalam penulisan ulama Melayu dan; (3) impak emansipasi wanita terhadap konsep pemerkasaan wanita.

DAPATAN KAJIAN

Melalui metodologi yang digunakan, kajian ini tertumpu kepada penghasilan definisi emansipasi wanita yang komprehensif dan bentuk-bentuk emansipasi wanita berdasarkan perspektif ulama Melayu seperti yang dibincangkan dalam penulisan mereka. Melalui definisi dan bentuk-bentuk emansipasi ini, maka terhasil garis panduan emansipasi wanita yang boleh dijadikan rujukan dan solusi pada masa kini. Definisi dan bentuk-bentuk emansipasi wanita ini dinilai oleh pakar-pakar yang berautoriti. Dapatan kajian adalah seperti yang berikut:

Definisi Bagi Konsep Emansipasi Wanita Berdasarkan Perspektif Ulama Melayu

Emansipasi berasal dari bahasa Latin ‘emancipatio’ yang membawa maksud pembebasan dari kekuasaan (Hasri, 2018). Istilah ini sering dikaitkan dengan wanita kerana ia bermaksud “pemberian hak yang dalam hukum antara wanita dan lelaki” (Kamus Dewan Edisi Keempat, 2010). Secara khusus, emansipasi wanita boleh difahami sebagai “pembebasan wanita daripada perhambaan ataupun pemberian hak yang sama dalam hukum iaitu wanita mendapat hak yang sama dengan lelaki” (Dewan Bahasa dan Pustaka, 2015).

Melalui semua definisi di atas, dapat dirangkumkan bahawa emansipasi wanita ialah pembebasan wanita daripada sesuatu kuasa dengan memberi mereka hak-hak yang sepatutnya dimiliki oleh wanita sama rata dengan kaum lelaki. Walau bagaimanapun, kajian ini telah mendapati terdapat definisi yang khusus berkaitan emansipasi wanita menurut pandangan ulama Melayu melalui karya-karya mereka. Kajian ini tidak menemui definisi secara literal emansipasi wanita dalam teks penulisan ulama Melayu, namun para ulama membahaskan konsep emansipasi wanita secara khusus dan umum dalam karya-karya mereka.

Definisi pertama emansipasi wanita ialah pembebasan wanita berlandaskan prinsip-prinsip Islam daripada sebarang diskriminasi dan amalan tradisional yang telah meletakkan wanita di dalam satu bidang khusus terutamanya berkaitan dengan 'bidang peribadi'. Pada awal abad ke-20, tugas wanita Melayu hanya berkisarkan kepada fungsi biologi dan sosial rumah tangga sahaja (Mahani Musa, 2010). Mereka hanya berperanan dalam menguruskan kerja-kerja dapur, membasuh dan mengasuh anak. Malah, tidak semua wanita ketika itu mendapat pendidikan formal seperti kaum lelaki.

Para ulama ketika itu berperanan penting membebaskan wanita daripada amalan tradisional masyarakat Melayu. Sebagai contoh, Syed Syeikh Ahmad al-Hadi (1867-1934) dalam Kitab Alam Perempuan dan Abdullah Abdur-Rahman (1876-1950) dalam *Risalah Seruan Kepada Jenis Yang Lembut: Perempuan-Perempuan* menekankan bahawa wanita juga perlu menuntut ilmu pengetahuan formal seperti kaum lelaki kerana ilmu adalah perisai diri kepada wanita untuk berhadapan dengan cabaran kehidupan selari dengan peredaran masa. Melalui ilmu pengetahuan juga, wanita tidak mudah untuk ditindas dan didiskriminasi. Definisi ini juga bertepatan dengan pandangan ulama kontemporari, Prof. Dr. Yusuf al-Qardhawi (2018) bahawa wanita perlu dilayani dengan baik, dimuliakan, diberikan hak dan kebenaran untuk menuntut ilmu pengetahuan, bekerja dan berkahwin dengan lelaki yang mereka redhai.

Definisi kedua ialah pembebasan wanita daripada pelbagai faktor yang menyekat hak wanita serta penghapusan subordinasi patriarki wanita seperti mana yang telah digariskan dalam Islam. Menurut Syafe'i (2015), subordinasi wanita ditakrifkan sebagai satu penilaian atau anggapan bahawa wanita lebih lemah dan rendah daripada lelaki dalam kedudukan, fungsi dan peranan disebabkan oleh sosial-budaya masyarakat. Manakala, menurut Vemma & Nadiroh (2019), patriarki ialah satu pemahaman yang menempatkan kaum lelaki sebagai pemegang kuasa utama dalam bidang ekonomi, politik dan sosial-budaya serta menempatkan wanita sebagai golongan kedua.

Abdullah Abdur-Rahman (1876-1950) dalam *Risalah Seruan Kepada Jenis Yang Lembut: Perempuan-Perempuan* berpendapat bahawa wanita memang memiliki sifat lemah lembut, akan tetapi menjadi lembut itu tidak menjadi kelemahan bagi mereka, bahkan dengan kelembutan yang dimiliki oleh wanita, mereka juga mampu untuk melakukan pelbagai perkara selagi mana menjaga batasan yang ditetapkan oleh Islam dan mereka berhak untuk menerima kehidupan yang sewajarnya sebagai seorang wanita (Abdullah, 2017).

Definisi ketiga emansipasi wanita ialah pemberian hak kepada wanita secara adil bagi memenuhi tanggungjawab dan menyumbang bakat serta kebolehan mereka dalam aspek fardhu kifayah sebagai khalifah Allah seperti yang termaktub dalam syariat agama Islam. Mohammad Idris Abdul Raof al-Marbawi dalam *Bahr al-Madhi* menegaskan bahawa lelaki dan wanita mempunyai tanggungjawab sebagai khalifah Allah di muka bumi mengikut kesesuaian masing-masing. Hakikat kepimpinan setiap individu ini telah dinyatakan oleh Nabi Muhammad SAW bahawa setiap manusia adalah pemimpin dan bertanggungjawab terhadap apa yang dipimpin. Bahkan, dalam Al-Quran juga diabadikan kisah Ratu Balqis iaitu seorang tokoh kepimpinan wanita yang memimpin kerajaan. Ini menunjukkan bahawa wanita juga boleh memainkan peranan sebagai pemimpin di luar rumah. Hamka, tokoh ulama Nusantara juga berpandangan bahawa dalam konteks kepimpinan dunia hari ini, wanita diharuskan memegang jawatan tertinggi negara (Hamka, 2014).

Jadual 2: Pandangan Penilai Terhadap Definisi Emansipasi Wanita

Definisi	Pandangan Pakar	
Pembebasan wanita daripada sebarang diskriminasi dan amalan tradisional yang telah meletakkan wanita di dalam satu bidang khusus terutamanya berkaitan dengan ‘bidang peribadi’ berlandaskan prinsip-prinsip Islam.	Pakar A	Bersetuju, namun pakar mencadangkan untuk meletakkan ‘prinsip-prinsip Islam’ pada awal definisi.
	Pakar B	Tidak bersetuju kerana tiada bukti empirikal bahawa wanita Melayu tidak mendapat pendidikan formal seperti lelaki.
	Pakar C	Bersetuju.
Pembebasan wanita daripada pelbagai faktor yang menyekat hak-hak wanita dan penghapusan subordinasi patriarki seperti mana yang telah digariskan di dalam Islam.	Pakar A	Bersetuju.
	Pakar B	Bersetuju, namun pakar mencadangkan supaya takrif subordinasi patriarki diberikan huraian yang jelas.
	Pakar C	Bersetuju, namun pakar mencadangkan supaya takrif subordinasi patriarki diberikan huraian yang jelas.
Pemberian hak kepada wanita bagi memenuhi tanggungjawab mereka sebagai khalifah Allah seperti yang termaktub dalam syariat agama Islam.	Pakar A	Bersetuju, namun pakar mencadangkan definisi ini diselitkan ‘sebagai khalifah Allah dalam hal kepimpinan yang bersesuaian.’
	Pakar B	Bersetuju.
	Pakar C	Bersetuju.

Bentuk-bentuk Emansipasi Wanita dalam Penulisan Ulama Melayu

Terdapat empat bentuk emansipasi wanita yang telah ditekankan oleh ulama Melayu bagi memelihara hak-hak wanita, pertama; emansipasi wanita meliputi pendidikan. Para ulama Melayu menyatakan bahawa ilmu pengetahuan wajib dituntut oleh kaum lelaki dan wanita seperti yang telah disarankan dalam Islam (Al-Hadi, 2019). Semua lelaki dan wanita berhak mendapat pendidikan yang sama mengikut bidang kepakaran dan minat masing-masing tanpa paksaan. Syed Syekh Ahmad al-Hadi (1867-1934) menyarankan dalam bukunya *Kitab Alam Perempuan* agar wanita mempelajari pelbagai cabang ilmu pengetahuan supaya dapat memberi manfaat yang besar kepada diri sendiri, keluarga dan negara. Beliau juga menyeru wanita Melayu agar mencontohi kaum wanita di Mesir yang berusaha bersungguh-sungguh mendapatkan pendidikan sehingga mencapai kejayaan.

Kedua, emansipasi wanita meliputi sosial. Para ulama melihat emansipasi wanita adalah satu elemen penting yang perlu dilakukan bagi mengubah tradisi budaya dan sosial masyarakat di Tanah Melayu. Mereka membuka minda masyarakat Melayu untuk melibatkan wanita Melayu dalam aktiviti sosial masyarakat. Sebagai contoh, Haji

Muhammad Said (1854-1932) dalam *Tafsir Nur al-Ihsan* menyatakan bahawa wanita pada zaman Nabi Muhammad dibenarkan turut serta dalam peperangan dengan membantu kerja-kerja sosial seperti menyediakan ubat-ubatan, mengubati pasukan perang yang tercedera, memberi makanan dan menghantar pahlawan yang sakit ke kampung halaman. Di samping itu, Syed Syeikh Ahmad al-Hadi juga menampilkan tokoh-tokoh wanita yang banyak memberi sumbangan dalam bidang sosial seperti Salmah binti Umar al-Adawiyah, Hind binti ‘Utbah, ‘Umarah binti Kaab, Umm Hakim binti Harith, Asma binti Abu Bakar dan lain-lainnya.

Ketiga, emansipasi wanita meliputi politik. Kemajuan sesebuah negara tidak hanya bergantung kepada kaum lelaki semata-mata, wanita juga berperanan penting dalam bidang politik (Al-Hadi, 2019) dan kepimpinan negara mengikut kepakaran masing-masing. Di samping itu, para ulama juga bersetuju bahawa wanita perlu dilatih menjadi seorang pemimpin, hal ini kerana mereka bakal menjadi pemimpin dalam pelbagai kelompok kecil dalam masyarakat. Mereka memainkan peranan penting sebagai agen penyatuan dan perpaduan. Di samping itu, penglibatan wanita dalam politik akan meningkat semangat patriotisme dalam kalangan masyarakat.

Keempat, emansipasi wanita meliputi ekonomi. Para ulama Melayu amat menekankan kepentingan wanita menyertai ekonomi mengikut bakat dan kemampuan mereka. Sebagai contoh, Abdullah Abdur-Rahman (1876-1950) dalam *Risalah Seruan Kepada Jenis Yang Lembut: Perempuan-Perempuan* menekankan bahawa sebagaimana Islam telah mensyariatkan mas kahwin (mahar), harta pusaka dan transaksi kewangan bagi wanita seperti yang dinyatakan dalam al-Quran dan hadis, maka, wanita dibenarkan menjana pendapatan dengan menyertai aktiviti ekonomi dan transaksi perniagaan. Beliau berkata, “Dan diberi dan diluluskan pada perempuan itu haqq berjual beli, sewa menyewa, dan beri memberi dan bersedeqah dan lain-lainnya.” Di samping itu, Syed Syeikh Ahmad al-Hadi juga turut mengiktiraf Khadijah binti Khuwailid sebagai seorang usahawan wanita yang berjaya. Beliau merujuk kepada kisah Khadijah untuk menggambarkan bahawa wanita juga berhak menjalankan peranan selain domestik.

Jadual 3: Pandangan Penilai Terhadap Bentuk-bentuk Emansipasi Wanita

Bentuk-bentuk Emansipasi Wanita	Pandangan Pakar	
Emansipasi wanita meliputi pendidikan.	Pakar A	Bersetuju wanita perlu mempelajari pelbagai cabang ilmu namun bergantung kepada cabang ilmu yang bersesuaian dengan fitrah dan keupayaan wanita.
	Pakar B	Bersetuju wanita perlu mendapat hak pendidikan sama seperti lelaki namun perlu mengikut bidang kepakaran dan minat masing-masing tanpa paksaan.
	Pakar C	Bersetuju untuk wanita mendapat hak pendidikan dan mempelajari pelbagai cabang ilmu seperti kaum lelaki namun ilmu kemahiran hidup dan pengurusan rumah tangga tidak boleh diabaikan.
Emansipasi wanita meliputi sosial.	Pakar A	Bersetuju untuk membenarkan wanita Melayu aktif dalam aktiviti kemasyarakatan, namun beliau mencadangkan untuk menyenaraikan contoh-contoh penglibatan supaya lebih jelas untuk dipraktikkan.
	Pakar B	Sangat setuju untuk membenarkan wanita aktif dalam aktiviti kemasyarakatan.
	Pakar C	Bersetuju wanita Melayu aktif dalam aktiviti kemasyarakatan kerana peranan wanita dalam

			bidang sosial selari dengan peranan amar ma'ruf dan nahi mungkar serta sebagai pendakwah.
Emansipasi wanita meliputi politik.	Pakar A		Bersetuju wanita diberi tanggungjawab dalam kepimpinan.
	Pakar B		Bersetuju wanita diberikan peranan dalam politik dan kepimpinan sama seperti kaum lelaki mengikut kepakaran masing-masing.
	Pakar C		Bersetuju kerana wanita juga menjadi pemimpin dalam pelbagai kelompok kecil. Oleh itu, mereka perlu dilatih supaya mempunyai ciri-ciri kepimpinan.
Emansipasi wanita meliputi ekonomi.	Pakar A		Bersetuju wanita boleh meyertai dalam aspek ekonomi untuk kemakmuran rumah tangga dan negara.
	Pakar B		Bersetuju untuk wanita aktif dalam bidang ekonomi namun perlu menjaga batas sosial kerana apabila tidak terjaga ia boleh mengganggu hak emansipasi wanita lain.
	Pakar C		Bersetuju kerana tidak semua wanita mendapat nafkah daripada keluarga. Ada wanita yang terpaksa berdikari menyara kehidupan. Oleh itu, semua wanita perlu diberi kemahiran untuk membangunkan ekonomi diri sendiri dan keluarga.

ANALISIS DAN PERBINCANGAN

Melalui dapatan kajian yang dibincangkan sebelum ini, kajian ini kemudiannya menganalisis penilaian pakar-pakar terhadap garis panduan yang telah dibangunkan yang mengandungi pendekatan baharu dalam memahami isu wanita berdasarkan teks penulisan ulama Melayu. Garis panduan yang dibina adalah untuk memperkasakan wanita dalam aspek ilmu dan pendidikan, aspek sosio-ekonomi dan keseimbangan wanita dalam mengurus keluarga dan kerjaya. Penjelasan garis panduan bagi setiap aspek yang berkaitan adalah seperti di bawah:

Pemerksaan Wanita dalam Aspek Ilmu dan Pendidikan

Aspek utama yang telah ditekankan oleh ulama Melayu bagi memperkasakan wanita ialah kepentingan menuntut ilmu sama ada ilmu dunia ataupun ilmu agama yang menjadi kewajipan oleh setiap manusia. Dengan memiliki ilmu, ia dapat menonjolkan kebijaksanaan wanita Melayu Islam serta menambahkan pelbagai nilai yang baik di dalam diri mereka dan orang lain. Dalam suasana sekarang, pelbagai medium dalam media sosial boleh digunakan oleh wanita untuk menambah ilmu pengetahuan. Namun begitu, ia memerlukan garis panduan untuk memandu wanita bagi mengenal pasti sumber ilmu yang sahih dan benar.

Dengan mempunyai ilmu pengetahuan juga wanita mampu menghadapi cabaran hidup seiring dengan peredaran masa dan perkembangan zaman. Tema sambutan Hari Wanita Kebangsaan 2021 iaitu 'Wanita Bangkit Mendepani Cabaran' bertepatan dengan masa kini ekoran pelbagai cabaran yang perlu dihadapi oleh wanita termasuklah isu ketidaksetaraan gender, keganasan rumah tangga dan sebagainya (Nur Faedah, 2021). Oleh itu, menurut Nur Wakhidah (2019), ilmu akan membentuk pola pemikiran wanita dan menjadikan mereka mampu untuk berfikir secara kritis dan kreatif sehingga mampu untuk membuat keputusan yang baik serta mampu menghadapi cabaran kehidupan yang kian mencabar dengan tenang.

Selain itu, wanita juga memerlukan ilmu untuk berdikari dan mampu memelihara dirinya daripada pelbagai bentuk diskriminasi. Hal ini telah ditekan oleh para ulama bahawa ilmu dan pendidikan tidak seharusnya disekat bagi kaum wanita, kerana anjuran agama untuk menuntut ilmu adalah adil buat semua peringkat manusia. Untuk membolehkan wanita menuntut ilmu dengan baik, wanita memerlukan sistem sokongan yang mantap, sama ada daripada keluarga atau kerajaan.

Di samping itu, wanita memerlukan ilmu dan pendidikan untuk menjayakan peranan mereka sebagai guru pertama kepada anak-anak serta tonggak penting dalam sesebuah keluarga. Menurut Perdana Menteri Malaysia, Dato' Sri Ismail Sabri bin Yaakob (2022), keutuhan negara terikat dengan nilai didikan sempurna oleh seorang wanita dalam sesebuah keluarga. Oleh itu, menjadi kepentingan kepada wanita memiliki ilmu dalam mendidik generasi baharu. Bahkan, wanita juga memiliki peranan yang sangat besar dalam kehidupan masyarakat dan pendidikan adalah solusi tepat bagi wanita mengali potensi yang dimiliki dan daripada kebijaksanaan wanita juga akan lahir para cendekiawan yang akan memajukan peradaban dunia (Musa & Husin, 2018).

Tambahan itu, dengan ilmu pengetahuan wanita mampu memperkasakan orang sekeliling dalam berkongsi maklumat dan pengetahuan. Sebagai contoh, Saidatina Aisyah Abu Bakar yang merupakan seorang tokoh wanita yang mempunyai pengetahuan yang tinggi dan cerdas, beliau bukan sahaja menjadi guru kepada wanita yang lain bahkan kepada kaum lelaki juga (Wihidayati, 2020). Ramai para sahabat yang meriwayatkan hadis Nabi Muhammad melalui beliau seperti Umar al-Khattab, Abdullah bin Umar, Abu Hurairah, Abu Musa al-Asha'ari, Abdullah bin Abbas dan ramai lagi (Akram, 2020).

Kepentingan menuntut ilmu bagi wanita dipandang serius dari zaman ke zaman. Walaupun kini rekod kemasukkan pelajar di kebanyakan institusi pengajian rendah dan tinggi pada zaman kini telah dikuasai oleh kaum wanita yang menjadi majoriti berbanding kaum lelaki. Namun, ilmu bukan sahaja dinilai berdasarkan sijil tetapi ia menjadi sandaran bagi wanita dalam apa sahaja keadaan yang dihadapi. Ini akan membantu wanita memahami bahawa emansipasi wanita boleh dicapai sekiranya wanita mempunyai ilmu dan keupayaan untuk mempertahankan hak dan keadilan buat diri mereka sendiri.

Pemeriksaan Wanita dalam Aspek Sosio-Ekonomi

Sosio-ekonomi adalah merujuk kepada kedudukan sosial atau kelas bagi seseorang individu atau kumpulan yang sering diukur sebagai gabungan terhadap aspek pendidikan, keluarga, masyarakat, pendapatan dan pekerjaan (Norazlinda, 2011). Status sosio-ekonomi ini boleh merangkumi kualiti hidup serta peluang dan keistimewaan yang diberikan kepada seseorang individu dalam keluarga, masyarakat dan negara (Mujadeed & Amirul, 2018). Dalam konteks masyarakat Malaysia kini, penglibatan wanita dalam sosio-ekonomi semakin bertambah dan mula melangkah ke persada antarabangsa.

Rentetan itu, pemeriksaan wanita dalam sosio-ekonomi ini sangat penting dalam menjadikan wanita sebagai individu yang bukan sahaja berjaya dalam keluarga, tetapi dalam masyarakat dan juga negara. Islam amat menekankan kepentingan wanita untuk menyertai sosio-ekonomi mengikut bakat dan kemampuan mereka. Sejarah Islam telah mencatatkan ramai wanita Islam yang telah diikraf sebagai ahli perniagaan wanita yang hebat (Fadli, 2012). Hak penyertaan wanita dalam ekonomi adalah penting untuk mereka mampu berdikari dan tidak bergantung kepada sumber kewangan daripada satu sumber sahaja. Kemampuan untuk memiliki harta boleh meningkatkan keyakinan buat wanita untuk membebaskan diri daripada pandangan konservatif yang menyekat wanita untuk terlibat sama di dalam isu masyarakat.

Dalam sejarah Islam, telah direkodkan bahawa wanita memainkan peranan penting dalam menjayakan aktiviti yang melibatkan aspek sosial dan ekonomi, khususnya pada zaman

Nabi Muhammad SAW dan Khulafa' al-Rasyidin. Ini mendorong Khalifah Umar al-Khattab melantik Shifa' binti Abdullah bertanggungjawab mengurus hal-hak perniagaan di pasar Madinah dan diperlukan untuk membantu memperkukuhkan kestabilan ekonomi negara. Beliau mendapat kepercayaan penuh dari Umar, malah pandangannya sering diambil kira dalam pengurusan pasar dan pentadbiran (Ummu Isra, 2019). Terdapat pelbagai contoh wanita Muslimah lain yang mempunyai sumbangan besar dalam aspek sosio-ekonomi, dan ia seharusnya menjadi tauladan bagi wanita di Malaysia.

Dalam era kemajuan Malaysia kini, penyertaan wanita dalam sektor ekonomi haruslah diraikan oleh pelbagai pihak terutamanya suami ataupun ketua keluarga dan pihak kerajaan. Kebenaran untuk wanita keluar mencari rezeki akan dapat membantu suami dan keluarga dalam memperbaiki dan meningkatkan taraf hidup terutama pada zaman kegawatan ekonomi yang memerlukan perbelanjaan yang besar untuk keperluan isi rumah. Walau bagaimanapun, wanita yang menjadi suri rumah juga dapat dinilai kemenjadiannya dalam aspek ekonomi apabila dapat mengurus tadbir kewangan keluarga dengan bijak tanpa ada pemborosan dan pembaziran.

Dalam situasi norma baharu hari ini, wanita boleh melibatkan diri dalam sistem ekonomi seperti perniagaan dan pemasaran melalui penggunaan teknologi digital iaitu berniaga secara dalam talian. Penyediaan khidmat penghantaran produk terus ke rumah pelanggan dan pengguna juga dapat memudahkan urusan perniagaan. Selain itu, terdapat pelbagai bantuan promosi di media sosial yang dapat digunakan supaya produk dapat dikenali secara meluas. Penglibatan pihak kerajaan dalam menyediakan dana dan sokongan kepada wanita dapat memperkasakan wanita dalam bidang ekonomi.

Kesimpulannya, walaupun Islam bersetuju bahawa wanita dibenarkan keluar untuk menyumbang dalam bidang sosio-ekonomi, namun begitu, kaum wanita masih perlu mematuhi batasan sosial dan moral agar tidak melanggar batasan agama dan budaya. Di samping itu, kaum wanita perlu mengambil kira untuk mengimbangi tanggungjawab yang digalas sama ada di dalam atau di luar rumah.

Pemeriksaan Wanita dalam Keseimbangan Keluarga dan Kerjaya

Penglibatan wanita dalam bidang kerjaya di Malaysia semakin menunjukkan peningkatan yang positif. Kesibukan mereka bekerja di luar rumah sering menimbulkan isu untuk menyeimbangkan tanggungjawab dalam menguruskan diri, keluarga dan kerjaya. Keseimbangan antara kehidupan dan kerjaya boleh dirujuk sebagai individu yang bekerjaya yang memenuhi komitmen kerja dan mampu untuk menikmati kehidupan peribadi, sosial dan keluarga dengan baik (Srivastava, 2016). Konsep pemeriksaan wanita dalam keseimbangan keluarga dan kerjaya telah diberi panduan oleh ulama Melayu.

Dalam menyeimbangkan tanggungjawab di dalam dan luar rumah, para ulama menasihati agar suami dan isteri mesti saling tolong-menolong dan memahami antara satu sama lain (Abdullah, 2017). Kunci untuk mewujudkan kesefahaman ialah saling berkomunikasi dan bertolak ansur. Peranan besar di dalam dan di luar rumah akan menjadi pincang dan bercelaru jika tidak mendapat kefahaman dan kerjasama suami dan ketua keluarga yang melindunginya menjadi payung keteduhan dan ketengan jiwa bagi wanita serta sokongan moral yang kuat. Selain itu, suami dan isteri mesti saling memelihara kehormatan masing-masing di samping, mereka mesti mengetahui dan melaksanakan tanggungjawab mengikut perbincangan dan persetujuan antara suami isteri.

Keseimbangan dalam menjalankan tanggungjawab sebagai suami isteri menjadi faktor penting bagi menjamin keharmonian dan kebahagiaan rumah tangga. Ini adalah kerana kedua-duanya bekerjaya dan mempunyai tanggungjawab yang pelbagai selain tanggungjawab mereka yang hakiki di dalam institusi keluarga. Penglibatan wanita di dalam dunia luar, bukan

bermakna mereka mengabaikan tanggungjawab di rumah, namun mereka tetap menjadi isteri dan ibu yang terbaik (Adawiyah, 2018).

Dalam situasi hari ini, keseimbangan wanita dalam menguruskan keluarga dan kerjaya mestilah mendapat sokongan padu daripada ahli rumah terutamanya suami dan ahli keluarga. Walaupun bekerjaya, wanita perlu memperkasakan diri mereka dalam pelbagai aspek, namun pemerksaan utama adalah bermula dari rumah (Nur Saadah, 2020). Pemahaman yang sempurna berdasarkan ajaran Islam dan pemerksaan wanita mampu untuk mereka menumpukan perhatian kepada kerjaya dan mempunyai masa serta ruang yang cukup untuk meluangkan masa berkualiti bersama keluarga.

PENUTUP

Kajian ini mencapai objektif utama untuk menganalisis penilaian pakar terhadap garis panduan bagi emansipasi wanita menurut ulama Melayu abad ke-20. Semua pakar memberi komentar dan pandangan terhadap garis panduan yang telah disediakan, seterusnya kajian ini telah menambahbaik garis panduan ini sebagai rujukan dan solusi kepada cabaran dan isu-isu pemerksaan wanita pada era kini.

Panduan ini bukan sahaja ditujukan buat kaum wanita tetapi mesti diambil berat oleh kaum lelaki untuk sama-sama memperkasakan wanita dalam menghadapi cabaran norma baharu pada era kini. Sokongan kepada isu wanita juga bukan hanya wajar diperjuangkan oleh wanita sahaja, tetapi wajar untuk disokong oleh kaum lelaki bagi mengelakkan pandangan bahawa Islam memberi laluan kepada sistem patriarki yang bertentangan dengan amalan agama.

Di samping itu, panduan yang dihasilkan ini boleh dicadangkan kepada pihak kerajaan dan agensi-agensi yang terlibat. Ia bertetapan dengan tema hari wanita yang disambut pada tahun 2022 'Saksama Bersama'. Tema ini bersesuaian bagi menekankan semangat kesaksamaan dalam usaha memperkasakan wanita bagi mendapat ruang dan peluang yang adil untuk memajukan potensi diri ke arah kehidupan lebih bermakna dan sejahtera.

Kajian ini juga berjaya membuktikan bahawa emansipasi wanita mendapat sokongan ulama Melayu. Kandungan penulisan para ulama Melayu selari dengan ajaran agama yang mengangkat al-Quran dan hadis sebagai rujukan utama dan memperkukuhkan lagi fakta di mana kedatangan Islam membawa perubahan dan impak yang positif ke atas wanita. Setiap karya yang ditulis oleh ulama Melayu ini boleh dirujuk oleh segenap masyarakat tanpa mengira agama mahupun bangsa, tua ataupun muda untuk mengetahui hak-hak wanita dan perjuangan bagi emansipasi wanita yang boleh dijadikan panduan dalam kehidupan.

RUJUKAN

- Abdullah, A. R. (2017). *Risalah Seruan Kepada Jenis Yang Lembut: Perempuan-Perempuan*. Kuala Lumpur: Akademi Jawi Malaysia.
- Adawiyah, I. & Salasiah, H. (2012). Kefahaman Terhadap Kedudukan Wanita Bekerjaya Menurut Islam. *Jurnal Al-Hikmah*, 4(2), 3–14.
- Akram, A. N. (2020). *Al-Wafa bi Asma' al-Nisa*. Jeddah: Dar al-Minhaj.
- Al-Hadi, S. S. (2019). *Kitab Alam Perempuan*. Kuala Lumpur: Akademi Jawi Malaysia.
- Babbie, E. (2012). *The Practice of Social Science Research*. USA: Chapman University.
- Debnath, D., Rahman, M. S., Acharjee, D. C., Latit, W. U., & Wang, L. (2019). Empowering Women Through Microcredit in Bangladesh: An Empirical Study. *International Journal of Financial Studies*, 7(37), 2–11.
- Fadli, M. (2012). *Peranan Wanita di dalam Sejarah Melayu Islam*. Kuala Lumpur. Tesis Ijazah Sarjana, Universiti Malaysia.

- Hamka, B. (2014). *Buya Hamka Berbicara dengan Perempuan*. Indonesia: Gema Insani.
- Hasri. (2018). Emansipasi Wanita di Negara Islam (Pemikiran Qasim Amin Di Mesir). *Al-Khwarizmi: Jurnal Pendidikan Matematika Dan Ilmu Pengetahuan Alam*, 2(2), 107–114.
- Ismail, S. (2022). *Wanita Insan Hebat Tonggak Utama Keluarga Malaysia*. Diakses pada 15 Oktober 2022 dari <http://www.utusan.com.my/commentary/wanita-insan-hebat-tonggak-utama-keluarga-malaysia/>
- Kamus Dewan. (2010). *Kamus Dewan Edisi Keempat*. Kuala Lumpur: Dewan Bahasa dan Pustaka.
- Mahani Musa. (2010). Wanita Melayu, Kesedaran Pendidikan dan Pembentukan Masyarakat Malaysia Modern. *Malaysia dari Segi Sejarah*, 28, 1–24.
- Mujaheed, M., & Amirul, R. (2018). *Faktor Penglibatan dan Cabaran Wanita Melayu dalam Bidang Keusahawanan*. Proceedings of the Conferenc: Tun Fatimah Hashim Women Lead Conference 2018 (TFHWLC 2018), November, 8-9. Universiti Putra Malaysia.
- Musa, N., & Husin, A. (2018). Semakan Dasar Wanita Kelantan: Penambahbaikan Pelaksanaan ke arah Mencapai Matlamat Pembangunan Mampan. *Akademika*, 88(3), 137–150.
- Niels, G., & Jacobs, T. (2017). *Content Analysis: A Short Overview*. New Zealand: University of Wellington.
- Norazlinda, G. (2011). *Meritokrasi: Faktor Sosio Ekonomi dan Peluang Pendidikan Tinggi*. Kedah. Tesis Ijazah Sarjana, Universiti Utara Malaysia.
- Nur Faezah, M. (2021). Peranan Wanita dalam Pembangunan Institusi Keluarga: Cabaran Pandemik Covid 19. *Jurnal 'Ulwan*, 6(2), 61–73.
- Nur Saadah, K. (2020). Syed Syeikh Ahmad al-Hadi's Thought on Women's Emancipation and Gender Equality: Re-Evaluation and Analysis. *Afkar-Jurnal Akidah & Pemikiran Islam*, [S.1], p. 157-184.
- Nur Wakhidah. (2019). Perempuan dalam Perkembangan Ilmu Pengetahuan dan Teknologi. *Jurnal Keadilan dan Keadilan Gender*, IV(2).
- Sabina, S. & Shamim, H. (2010). Impact of Micro-Credit on Economic Empowerment of Rural Women. *The Agriculturists*, 8(2), 43–49.
- Srivastava, N. (2016). Education: A Path to Women Empowerment (Issues and Challenges). *International Journal of Management Research & Review*, 4(1), 1–23.
- Syafe'i, I. (2015). Subordinasi Perempuan dan Implikasinya Terhadap Rumah Tangga. *Jurnal Studi Keislaman*, 15(1), 143–166.
- Ummu Isra, A. B. (2019). *Kerana Wanita Punya Sejarah: Kisah Hidup Para Perempuan Pengukir Peradaban Islam*. Jakarta: Qalam.
- Vemma, A., & Nadiroh. (2019). Penghapusan Budaya Patriarki di Masyarakat Melalui Pendidikan Bagi Perempuan. *Indonesian Journal of Geography*, 51(2), 115–122.
- Wihidayati, Y. (2020). Kecenderungan 'Aisyah R. A. *Jurnal Studi Al-Quran dan Hadis*, 4(2), 405–426.
- Yusuf, al-Q. (2018). *Wanita*. Selangor: Santai Ilmu Publication.

Peti Surat IOT Menggunakan ESP32

Nur Filzah binti Mohd Fauzey
Politeknik Kota Bharu
filzah@pkb.edu.my

Aqil Afsar bin Mohd Fozan
Politeknik Kota Bharu
aqilafsar@gmail.com

ABSTRAK

Peti surat merupakan satu sistem yang diperlukan dalam kehidupan seharian kita dan masih lagi relevan digunakan. Disebabkan kepelbagaian teknologi yang semakin canggih pada zaman sekarang, pengguna kurang memberi perhatian akan kehadiran surat di dalam peti surat mereka. Disebabkan itu, pengguna tidak menyedari terdapat surat-surat penting seperti surat daripada bank ataupun surat rasmi di dalam peti surat mereka. Oleh sebab itu, tujuan utama kajian ini adalah untuk menyelesaikan masalah tersebut daripada berlaku dengan membina satu sistem menggunakan ESP32, supaya tidak timbul masalah kelewatan menerima surat-surat yang penting. Penggunaan ESP32 kini digemari untuk aplikasi Internet of Thing (IOT) kerana harga modul yang agak murah dan menggunakan Arduino IDE untuk memprogramkan sesuatu arahan. Peti surat yang akan dibina ini akan menggunakan dua sensor iaitu, sensor IR dan sensor ultrasonik. Sensor IR untuk mengesan pergerakan ataupun objek dan memberi isyarat apabila surat diterima kepada LCD untuk memaparkan bilangan surat yang diterima. Manakala sensor Ultrasonik pula akan mengesan jarak objek yang hadir seterusnya servo motor akan membuka pintu peti surat secara automatik dan Buzzer akan berbunyi. Peti surat ini juga akan disambungkan ke Telegram Messenger Bot sebagai penghantar mesej untuk mengetahui kehadiran surat yang ada di dalam peti surat supaya pengguna tidak perlu risau atau bimbang surat sudah diterima atau belum.

Kata kunci: ESP32;IOT;Arduino;Peti surat;Sensor

PENGENALAN

Peti surat merupakan satu sistem yang diperlukan dalam kehidupan seharian kita. Sebelum era moden ini, masyarakat pada zaman dahulu menggunakan surat untuk berhubung antara satu dengan yang lain. Namun, perubahan zaman kini menjadikan sistem persuratan semakin ditinggalkan kerana era globalisasi yang menggunakan sistem komunikasi yang semakin canggih seperti Whastapps, Telegram, E-mail, Facebook dan Twitter. Sistem persuratan kini kebanyakan hanya melibatkan penghantaran dokumen-dokumen atau surat-surat penting. Ini kerana surat dan dokumen penting ini tidak dapat dihantar melalui sesetengah sistem komunikasi yang dinyatakan tadi. Oleh itu, peti surat masih lagi relevan penggunaannya dalam kehidupan seharian manusia.

Disebabkan kepelbagaian teknologi yang semakin canggih pada zaman sekarang, pengguna kurang memberi perhatian akan kehadiran surat di dalam peti surat mereka. Hal ini boleh menyebabkan masalah seperti terlepas peluang temuduga, kelewatan membayar bil-bil elektrik berikutan sikap sesetengah pengguna yang tidak memberi perhatian terhadap kehadiran surat di dalam peti surat mereka. (Lynuana,2015)

Tujuan utama kajian ini adalah untuk membina satu sistem menggunakan ESP32, untuk menyelesaikan masalah yang timbul daripada pengguna di mana pengguna tidak tahu surat

yang penting telah diterima ataupun tidak. Disebabkan itu, projek ini dijalankan untuk menghentikan masalah tersebut menggunakan ESP32 untuk mengawal sistem, sensor ultrasonik untuk memancar gelombang bunyi melalui transmitter, sensor IR untuk mengesan pergerakan manakala buzzer untuk memberi isyarat apabila surat diterima dan LCD untuk memaparkan bilangan surat yang diterima. Telegram juga digunakan untuk mengetahui bilangan surat yang ada di dalam peti surat supaya pengguna tidak perlu risau atau bimbang surat sudah diterima atau tidak.

KAJIAN LITERATUR

Mikropengawal ESP32

ESP32 ialah nama sebuah mikropengawal yang direka oleh sebuah syarikat yang berpangkalan di Shanghai, China iaitu Espressif Systems. ESP32 menawarkan penyelesaian rangkaian WiFi sendiri sebagai jambatan daripada mikropengawal sedia ada kepada rangkaian WiFi. Menurut (Wahyudi,2014), ESP32 menggunakan pemproses dwi teras yang dijalankan pada arahan Xtensa LX16. ESP32 juga mempunyai spesifikasi seperti yang ditunjukkan dalam Jadual 1.

Jadual 1: Spesifikasi ESP32

No	Atribut	Detail
1	Tegangan	3.3 Volt
2	Prosesor	Tensilica L108 32 bit
3	Kecepatan prosesor	Dual 160MHz
4	RAM	520K
5	GPIO	34
6	ADC	7
7	Dukungan 802.11	11b/g/n/e/i
8	Bluetooth	BLE (Bluetooth Low Energy)
9	SPI	3
10	I2C	2
11	UART	3

Perisian Arduino IDE digunakan untuk memprogramkan ESP32 bagi menyusun dan memuat naik program ke dalam mikropengawal ESP32. Library atau perpustakaan perlu digunakan supaya IDE Arduino dapat memprogramkan ESP32. Aplikasi blynk dan modul yang dibenamkan juga memerlukan perpustakaan tambahan supaya program boleh dikenali oleh Arduino IDE, seperti perpustakaan blynk, LCD, MFRC522 dan RTC. Arduino IDE juga mempunyai ciri yang dipanggil monitor bersiri yang berfungsi menghantar dan menerima mesej dari komputer ke mikropengawal atau sebaliknya melalui USB, (Hendra et al., 2019).

Daripada jadual 1 di atas dapat disimpulkan ESP 32 berfungsi untuk sambungan berkelajuan tinggi dan mempunyai prosesor 32-bit, ia juga boleh mencapai prestasi optimum dengan hanya beberapa peranti perkakasan. Di dalam ESP32 juga telah ada Wi-Fi, Bluetooth dan GPIO yang lebih banyak. Pelbagai mod kawalan termasuk GPIO, ADC, I2C dan juga UART dan sesuai untuk pengguna yang perlu memasukkan pelbagai aplikasi ke dalam sistem pengguna.

Menurut (Zaini et al., 2020), ESP32 adalah mikrokontroler yang diperkenalkan oleh Espressif System merupakan penerus dari ESP8266. Selain itu ESP32 juga memiliki keunggulan jika dibandingkan dengan mikrokontroler yang lain, mulai dari pin out yang lebih banyak, pin analog yang lebih banyak, memori yang lebih besar, serta terdapat *low energy Bluetooth* 4.0 (Pradisti et al.,2018). Pada mikrokontroler ini sudah tersedia modul WiFi dalam

chip prosesor dual core yang berjalan di arahan Xtensa LX16 sehingga sangat mendukung untuk membuat sistem aplikasi *Internet of Things*, (Wahyudi,2014). Memori ESP32 terdiri daripada 448 kB ROM, 520 kB SRAM, dua 8 kB RTC memory, dan flash memory 4MB. Chip ini mempunyai 18 pin ADC (12-bit), empat unit SPI, dan dua unit I2C. Menurut (Wagyana,2019), kelebihan utama mikrokontroler ini ialah harganya yang relatif murah, mudah diprogram, memiliki jumlah pin I/O yang memadai,serta memiliki adapter WiFi.

Sensor Infra Merah (IR)

Pengesan seperti transduser, pengesan ultrasonik, pengesan infra merah (IR) dan pelbagai jenis pengesan yang lain boleh digunakan untuk menentukan arah pergerakan. Dari kumpulan pengesan, pengesan yang paling sering digunakan untuk pengesanan halangan dan pengukuran jaraknya adalah pengesan ultrasonik (Gopal, 2016). Pengesan ultrasonik kini banyak digunakan bagi mengesan jarak dan halangan terutamanya di dalam robot kerana harganya yang murah, kecekapan tinggi dan struktur binaan yang mudah. Gelombangnya mempunyai arah yang lebih baik dengan frekuensi yang rendah serta dilemahkan dengan cepat. Ianya menggunakan gelombang bunyi untuk mengukur jarak dan kelajuan gelombang bunyi bergantung kepada bilangan parameter persekitaran (Gopal, 2016).

Menurut Koval (2016), pengesan ultrasonik biasanya digunakan untuk mengesan jarak secara automatik, perubahan posisi, pengukuran aras dan pelbagai kegunaan khusus yang lain. Pengesan yang boleh disambung melalui pengantara antara muka ke komputer, boleh ditetapkan parameter julat dan jarak yang akan diukur. Pengesan ultrasonik menggunakan prinsip pantulan gelombang bunyi dan digunakan untuk mengukur jarak. Gelombang bunyi yang dipancarkan oleh pengesan ultrasonik akan dipantulkan kembali sekiranya terdapat objek dihadapannya. Pengesan akan mengesan gelombang ini dan diukur masa diantara gelombang dihantar dan diterima. Jarak kemudiannya dianggarkan diantara sela masa diantara pengesan dan objek (Nauriana, 2009).

Pengesan IR terdiri daripada dua bahagian iaitu IR LED sebagai litar pemancar dan IR photodiode sebagai litar penerima. IR LED akan memancarkan cahaya IR apabila voltan 5v dikenakan. Cahaya IR ini akan merambat melalui udara sehingga terkena objek. Cahaya IR yang terkena objek akan dipantulkan semula kepada pengesan digital IR Photodiode yang sangat sensitif terhadap cahaya IR yang dipancarkan oleh IR LED.

Pelbagai peralatan boleh berputar secara berterusan apabila motor arus terus disambungkan kepadanya. Gabungan teknik PWM dan H-Bridge membolehkan kelajuan dan arah putaran motor arus terus dikawal sepenuhnya. L298N adalah pemacu motor dua H-Bridge yang digunakan bagi mengawal kelajuan dan arah dua motor dalam satu masa. Litar H-Bridge mempunyai 4 elemen pensuisan, transistor atau MOSFET dan motor. Dengan mengaktifkan dua suis tertentu pada satu masa iaitu dengan mengubah arah pengaliran arus melalui motor, akan menyebabkan arah putaran motor bertukar. Hanya dengan mengubah voltan masukan, kelajuan pusingan akan bertukar. Manakala, dengan membalikkan arah voltan yang dikenakan, arah putaran juga akan bertukar (Jeremy, 2013).

Kelajuan motor boleh dikawal secara mengawal voltan masukan ke motor iaitu dengan menggunakan isyarat *Pulse Width Modulation* (PWM). PWM adalah teknik untuk membekalkan tenaga elektrik kepada beban yang mempunyai tindak balas yang agak perlahan. Isyarat bekalan terdiri daripada rangkaian denyutan voltan di mana lebar denyutan mengawal tahap voltan berkesan ke beban. Isyarat arus ulang alik (AC) dan arus terus (DC) boleh disimulasikan dengan PWM. Denyut PWM bertindak seperti isyarat DC apabila peranti yang menerima isyarat mempunyai masa tindak balas elektromekanik yang lebih lambat daripada frekuensi denyutan. Untuk motor DC, simpanan tenaga di belitan motor berkesan melancarkan aliran tenaga yang dikeluarkan oleh denyutan input supaya motor mengalami input kuasa

elektrik yang lebih rendah atau lebih besar bergantung pada lebar denyutan. Teknik ini membolehkan nilai purata voltan disesuaikan dengan peranti secara menghidupkan dan mematikan kuasa dengan kadar yang cepat. Voltan purata bergantung pada kitar tugas atau jumlah masa isyarat dihidupkan melawan jumlah masa isyarat dimatikan dalam satu kitar. Apabila isyarat kitaran tugas yang berbeza-beza dihantar iaitu arus yang dialirkan secara dihidupkan dan dimatikan dengan cepat melalui motor, ini boleh menyebabkan perubahan berlaku pada halaju (Jeremy, 2013). Pintu peti surat akan terbuka berpandukan putaran yang dikawal melalui pin kawalan motor berdasarkan kepada teori operasi motor seperti yang ditunjukkan dalam Jadual 2.

Jadual 2: Jadual Kebenaran Teori Operasi Motor

Masukan	
Logik	Servo Motor
0	Berhenti
1	Berpusing

Penetapan isyarat logik bagi voltan adalah bagi mengeluarkan dua jenis isyarat iaitu tinggi (1) dan rendah (0) sebagaimana yang ditunjukkan pada Jadual 3. Voltan bekalan kuasa penuh adalah untuk keadaan tinggi (1) dan voltan sifar untuk keadaan (0). Voltan isyarat masukan adalah berkisar dari 0 volt hingga 0.8 volt untuk keadaan logik rendah dan 2 volt hingga 5 volt untuk keadaan logik tinggi. Manakala, voltan isyarat keluaran adalah berkisar dari 0 volt ke 0.5 volt untuk keadaan logik rendah, dan 2.7 volt hingga 5 volt untuk keadaan logik tinggi (*Logic Signal Voltage Levels*, 2004).

Jadual 3: Tahap Voltan Isyarat Logik

Isyarat	Tahap Voltan	Isyarat Logik
Isyarat Masukan	0-0.8 volt	Rendah (0)
	2.0 - 5.0 volt	Tinggi (1)
Isyarat keluaran	0-0.5 volt	Rendah (0)
	2.7 - 5.0 volt	Tinggi (1)

SISTEM REKABENTUK PETI SURAT

Rajah 1 menunjukkan blok keseluruhan sistem bagi *IOT Postbox Using ESP32*. Terdapat dua perkakasan utama yang digunakan untuk menghasilkan postbox iaitu sensor IR dan sensor ultrasonik. Kesemua komponen-komponen ini dikawal oleh ESP32. Manakala Rajah 2 menunjukkan rekabentuk litar lengkap peti surat yang telah dihasilkan. Ianya terdiri daripada dua bahagian litar iaitu litar pengesan, litar ESP32, litar LCD dan juga litar servo motor. Peti surat yang dihasilkan ini menggunakan pengesan ultrasonik HCSR04 yang dipasang di hadapan peti surat bagi mengesan jarak obek di hadapan peti surat bagi membolehkan peti surat terbuka secara automatik. Manakala, pengesan IR digunakan untuk mengesan surat yang masuk di dalam peti surat.

Rajah 1: Gambarajah Blok Peti Surat

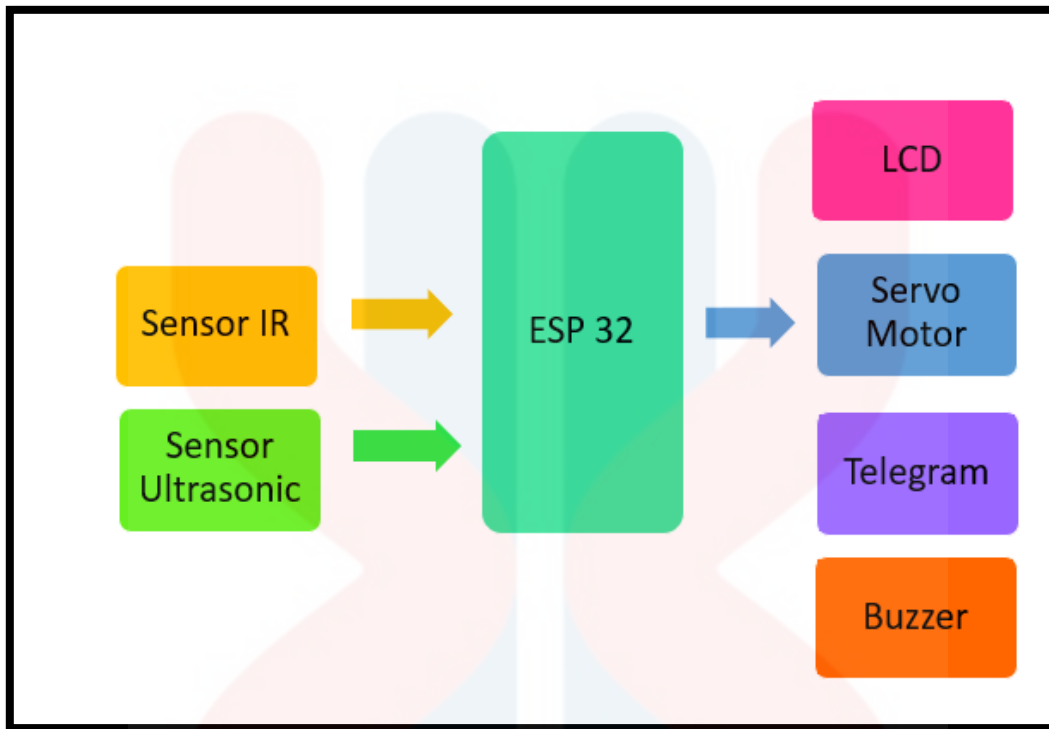

Rajah 2: Rekabentuk litar Peti surat

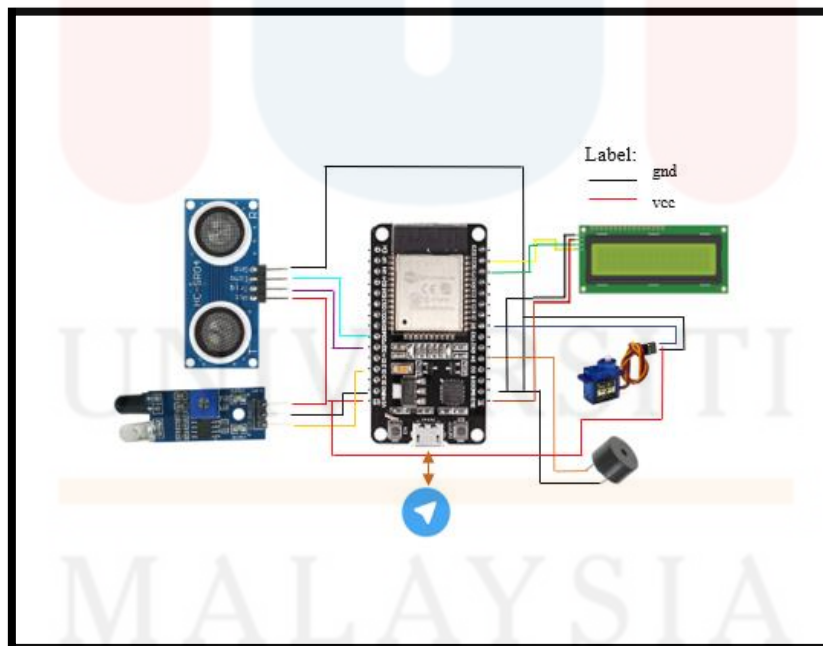

Masukan daripada pengesan infra merah (IR) dan pengesan ultrasonik di hantar kepada ESP32. ESP32 akan memberi arahan untuk menggerakkan motor bagi membolehkan motor berputar berdasarkan teori operasi motor seperti yang ditunjukkan pada Jadual 1. Bahasa pengaturcaraan direka berdasarkan cartalir yang ditunjukkan di dalam Rajah 3.

Rajah 3: Carta Alir Aturcara Peti Surat

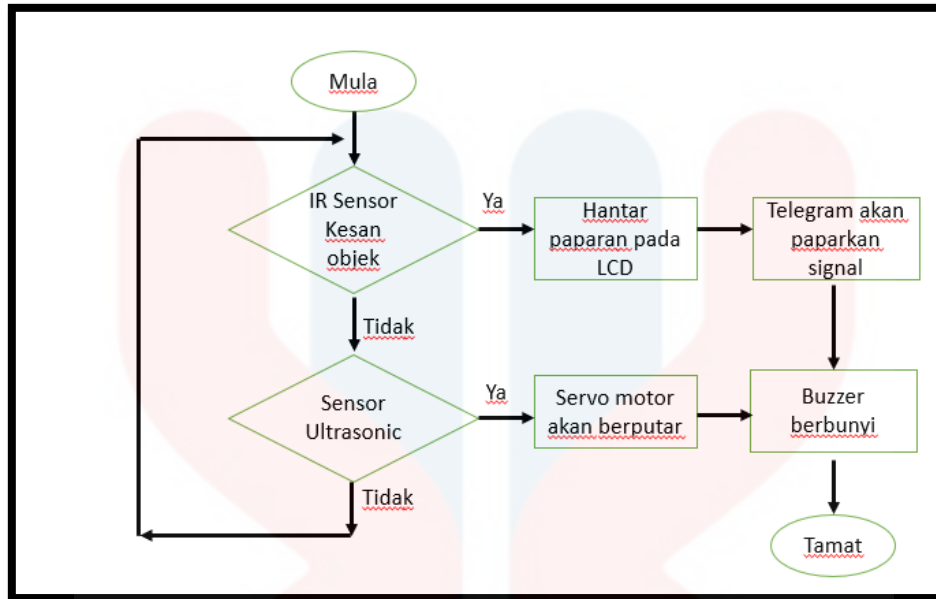

Rajah 4: Litar sambungan pada ESP 32 dan sensor ultrasonik

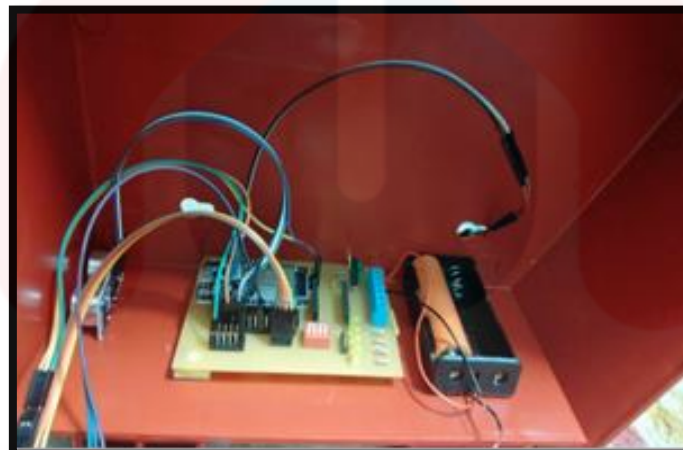

Rajah 5: Litar sambungan pada LCD dan sensor IR



KEPUTUSAN DAN ANALISA

Pengujian voltan dilakukan pada pin digital output sebanyak empat kali bagi sensor infra merah dan sensor ultrasonik. Jadual 4 menunjukkan keputusan pengujian yang telah dilakukan iaitu bagi sensor infra merah, didapati keputusan menunjukkan tahap voltan yang diukur adalah berbeza-beza disebabkan oleh penurunan voltan dalam litar. Manakala bagi sensor ultrasonik, penetapan nilai awal bagi jarak telah ditetapkan 5cm di dalam software Arduino. Satu objek datar diletakkan di hadapan sensor ultrasonik dan menggerakkan objek tersebut menjauhi ultrasonik mengikut jadual 4.

Jadual 4: Keputusan Pengujian Peti Surat

Jenis Sensor	Status Persekitaran	Status LED Sensor	Pengukuran Nilai Voltan Output Sensor			
			1x	2x	3x	4x
Inframerah (IR)	Ada Objek	Menyal a	0.3v	0.2v	0.2v	0.2v
	Tiada Objek	Tidak Menyal a	4.7v	5.2v	4.5v	4.8v
Jenis Sensor	Status Persekitaran	Status LED Sensor	Pengukuran Nilai Jarak (cm) Sensor			
			1x	2x	3x	4x
Ultrasonik	Ada Halangan	Menyal a	15cm	15.5cm	14.5cm	13cm

Apabila terdapat kemasukan surat ke dalam peti surat, sensor IR akan mengesan kehadiran surat, *buzzer* akan berbunyi. ESP32 akan menghantar maklumat ke paparan LCD dan juga paparan pada telegram. Manakala sensor ultrasonik akan mengesan halangan atau objek untuk membolehkan servo motor akan berpusing dan peti surat akan terbuka secara automatik.

Keputusan pengujian peti surat adalah seperti jadual 5 di bawah. Rajah 6 menunjukkan ujicuba yang telah dilakukan pada telegram bot dan paparan sekiranya surat diterima. Apabila ada kemasukkan surat ke dalam peti surat, buzzer akan berbunyi, servo motor akan berputar dan LCD akan memaparkan bilangan surat yang ada. Sekiranya tiada kemasukkan surat ke dalam peti surat, buzzer tidak akan berbunyi, servo motor tidak akan berputar dan tiada paparan bilangan surat pada LCD. Hasil daripada pengujian tersebut dapat membuktikan bahawa peti surat ini dikawal oleh ESP32, iaitu dapat mengesan kehadiran surat sekaligus dipaparkan di dalam telegram bot.

Jadual 5: Jadual Kebenaran Bagi Masukan dan Keluaran Peti Surat

Masukan	Keluaran					
Sensor IR	Buzzer		Servo Motor		LCD	
Persekitaran	Status	Digital	Status	Digital	Status	Digital
Ada Objek (0)	Bunyi	1	Berputar	1	Papar	1
Tiada Objek (1)	Tiada Bunyi	0	Tidak Berputar	0	Tiada Papar	0

Rajah 6: Pengujian Melalui Telegram Bot

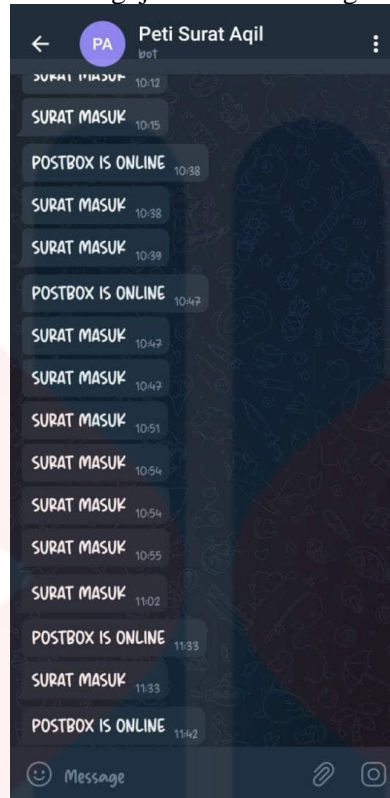

KESIMPULAN

Peti surat menggunakan ESP 32 ini adalah mesra pengguna kerana dapat membantu pengguna untuk mengetahui sekiranya ada surat di dalam peti surat melalui telegram. Peti surat ini juga dapat memaparkan berapa bilangan surat yang ada di dalamnya melalui paparan yang terdapat pada skrin LCD. Servo motor yang ada pada peti surat ini akan berputar secara automatik melalui kawalan pada ESP 32 dan membantu pengguna untuk membuka peti surat secara automatik.

Peti surat ini menggunakan bateri 12v yang boleh dicas semula dan menjimatkan. Peti surat ini boleh ditambah baik dengan meningkatkan kebolehannya berasaskan IOT dan boleh dijadikan sistem intercomm untuk perhubungan dua hala diantara penghuni di dalam rumah dan orang di sebelah luar (dekat peti surat).

RUJUKAN

- D'souza, M. L. (2014). Automated Trolley System. *International Journal Of Engineering Sciences & Research*.
- Dinsha, K. K. (2020). Line Tracing Trolley Using Arduino With Automatic Billing System. *International Journal of Advance Research and Innovative Ideas in Education(IJARIIE)*.
- Eka Dodi Suryanto, H. S. (2018). Design of Automatic Mobile Trolley Using Ultrasonic Sensors. *IOP Conf. Series: Journal of Physics*.
- Gopal, K. (2016). Effects of Environment on Accuracy of Ultrasonic Sensor Operates in Millimetre Range. *Perspective in Science*, 574-576.

- Hanifa, S. S. (2009). *Design And Development Of Pc Base For Controlling Robot Slider Via Bluetooth Application*. Faculty Of Manufacturing Universiti Teknikal Malaysia.
- Hendra K., Restu A. P., (2019), Penerapan Trainer Interfacing Mikrokontroler Dan Internet Of Things Berbasis Esp32 Pada Mata Kuliah Interfacing 2 Program Studi Sistem Komputer Universitas Raharja.
- Jeremy, B. (2013). *Exploring Arduino: Tools and Techniques for Engineering Wizardry*. Indianapolis: John Wiley & Sons.
- Kolban, N. 2017. Kolban's Book on ESP32. <https://leanpub.com/kolban-ESP32> .
- Koval, L. (2016). Distance Measuring by Ultrasonic Sensor. *IFAC Conference*, 153-158.
- Lessons in Electric Circuits Vol. IV - Digital : Logic Signal Voltage Levels*. (2004) Diambil daripada <https://www.allaboutcircuits.com/textbook/digital/chpt-3/logic-signal-voltage-levels/>
- McRoberts, M. (2010). *Beginning Arduino*. United States of America : Springer Science Business Media.
- Mohd Najib, H. (2014). *Three Phase Inverter for Induction Motor by Using Pirepetitive Controller With Arduino*. Faculty of Electrical and Electronic Engineering Universiti Tun Hussein Onn Malaysia.
- Nauriana. (2009). *Rancang Bangun Robot Beroda Penghindar Halangan*. Fakultas Teknik Universitas Indonesia.
- Pradisti, R., dan Mustaziri (2018). Rancang Bangun Alat Penghitung Biaya Penggunaan Listrik Kamar Kos Secara Otomatis Berbasis Arduino Menggunakan Sensor Arus, *TEKNIKA (Jurnal Ilmiah Bidang Ilmu Rekayasa)*, 12(2).
- Wahyudi, J.,(2014). Audit Energi Di Bidang Tata Cahaya Untuk Gedung Kampus Bonaventura UAJY, Skripsi, Universitas Atma Jaya Yogyakarta.
- Wagya, A., dan Rahmat,(2019).Prototipe Modul Praktik untuk Pengembangan Aplikasi Internet of Things (IoT), *SETRUM: Sistem Kendali Tenaga Elektronika Telekomunikasi Komputer*, 8(2).
- Zaini, M., Safrudin, dan Bachrudin, M.(2020). Perancangan Sistem Monitoring Tegangan, Arus Dan Frekuensi Pada Pembangkit Listrik Tenaga Mikrohidro Berbasis IoT, *TESLA: Jurnal Teknik Elektro*, 22(2).

Sejarah Perkembangan Al-Quran Barille di Malaysia

Anisah Razali

Pusat Penyelidikan Ibnu Ummi Maktum, Fakulti Pengajian Quran dan Sunnah, USIM
anisahrazali40@gmail.com

Noornajihan Ja'afar

Pusat Penyelidikan Ibnu Ummi Maktum, Fakulti Pengajian Quran dan Sunnah, USIM
noornajihan@usim.edu.my

Mohd Nur Adzam Rasdi

Pusat Penyelidikan Ibnu Ummi Maktum, Fakulti Pengajian Quran dan Sunnah, USIM
nuradzam@usim.edu.my

ABSTRACT

Efforts in developing the Mashaf Quran Braille in Malaysia require a detail process and involve various parties with special expertise in related fields. Recently, improvements were carried out to update the existing Quran Braille writing based on Mashaf Madinah which is one of Rasm 'Uthmani. This paper will discuss the development scenario of Quran Braille in Malaysia and an introduction to the background of Mashaf al-Quran Braille Malaysia (MQBM). This study uses a qualitative approach by applying the method of document analysis and interviews in the data collection process. The development of Quran Braille teaching in Malaysia includes five phases, (i) phase of copying the Quran Braille, (ii) the printing phase of the Quran Braille, (iii) the publication phase of the Quran Braille, (iv) the innovation phase of Quran Braille and (v) the improvement phase of the Quran Braille. While MQBM covers the background and initial introduction of its content. Therefore, this writing is expected to provide introduction and exposure to the community related to Quran Braille in Malaysia.

Keywords: *Quran Braille, Rasm Uthmani, Mashaf Al-Quran Braille Malaysia*

ABSTRAK

Usaha dalam membangunkan mashaf al-Quran Braille standard Malaysia memerlukan kepada proses yang teliti serta melibatkan pelbagai pihak yang berkepakaran khusus dalam bidang berkaitan. Baru-baru ini, penambahbaikan dijalankan bagi mengemaskini penulisan al-Quran Braille sedia ada dengan berpandukan kepada Mashaf Madinah yang merupakan salah satu mashaf Rasm Uthmani. Kertas kerja ini akan membincangkan senario perkembangan al-Quran Braille di Malaysia dan pengenalan kepada latar belakang Mashaf al-Quran Braille Malaysia (MQBM). Kajian ini menggunakan pendekatan kualitatif dengan mengaplikasikan kaedah analisis dokumen dan temu bual dalam proses pengumpulan data. Perkembangan pengajaran al-Quran Braille di Malaysia merangkumi lima fasa iaitu (i) fasa penyalinan al-Quran Braille, (ii) fasa pencetakan al-Quran Braille, (iii) fasa penerbitan al-Quran Braille, (iv) fasa inovasi al-Quran Braille dan (v) fasa penambahbaikan al-Quran Braille. Manakala MQBM mencakupi latar belakang dan pengenalan awal isi kandungannya. Oleh itu, penulisan ini diharapkan dapat memberi pengenalan dan pendedahan kepada masyarakat berkaitan al-Quran Braille di Malaysia.

Kata Kunci: *Al-Quran Braille, Rasm Uthmani, Mashaf al-Quran Braille Malaysia.*

PENDAHULUAN

Al-Quran adalah wahyu Allah yang diturunkan kepada Nabi Muhammad SAW untuk disampaikan kepada seluruh manusia sebagai panduan dan petunjuk dalam berkehidupan.

Umat Islam wajib untuk membaca dan memahami makna al-Quran serta menjalani ibadah berpandukan kitab suci al-Quran. Bagi komuniti OKU penglihatan, mereka memerlukan mashaf dalam versi tulisan timbul yang sesuai dengan keupayaan mereka dikenali sebagai mashaf al-Quran Braille. Braille merupakan salah satu daripada sistem tulisan berasaskan sentuhan yang paling popular dan relevan dalam kalangan mereka yang mengalami masalah penglihatan. Sistem ini telah dicipta oleh seorang warga Perancis yang bernama Louise Braille yang juga merupakan OKU Penglihatan. Beliau telah mendapat pengiktirafan dunia dalam meningkatkan literasi komuniti OKU Penglihatan membaca (Noornajihan Jaafar et al, 2022).

Al-Quran Braille adalah gabungan dua perkataan, iaitu al-Quran dan Braille (Siti Nur Azimah, 2014; Nur Atiqah 2016). Al-Quran Braille ini merujuk kepada mashaf al-Quran Braille yang menggunakan asas Kod Bahasa Arab versi Braille yang mewakili setiap huruf hijaiyyah (rasm), tanda baris dan bacaan (dabt) seperti *fathah*, *kasrah* dan *dhammah*, serta simbol-simbol seperti *syaddah*, *sukun*, *mad* dan sebagainya (Noornajihan dan Kauthar, 2008). Penghasilan mashaf al-Quran Braille merupakan salah satu alternatif bagi OKU Penglihatan untuk berinteraksi dengan al-Quran. Pada tahun 1950an telah muncul mashaf Quran yang pertama kali diterbitkan khas buat komuniti OKU penglihatan dengan menggunakan tulisan Braille di bawah usaha sama negara Palestin dan Jordan (Muhammad Mustaqim, 2013).

Kertas kerja ini bertujuan untuk meneroka sejarah perkembangan al-Quran Braille di Malaysia dengan memberi fokus kepada senario perkembangan Quran Braille di Malaysia dan pengenalan kepada MQBM. Kajian ini berbentuk kualitatif dengan menggunakan analisis kandungan dan temu bual untuk mendapatkan data dan maklumat.

PERKEMBANGAN PENGAJARAN AL-QURAN BRAILLE DI MALAYSIA

Mashaf al-Quran dalam tulisan Braille yang pertama dipercayai mula diterbitkan di awal tahun 1950an di Jordan. Antara negara Islam lain yang juga telah menghasilkan mashaf al-Quran versi Braille sehingga kini adalah Mesir (1962), Tunisia (1976), Indonesia (1976), Arab Saudi (1985), Malaysia (1999), Morocco, Yemen (2012) dan Turki (2013) (Noornajihan Jaafar et al., 2022).

Senario perkembangan al-Quran Braille di Malaysia telah dipelopori oleh Persatuan Orang-orang Cacat Penglihatan Malaysia (PERTIS). PERTIS adalah sebuah badan pertubuhan peringkat nasional yang memberi perkhidmatan kepada komuniti OKU Penglihatan dengan melaksanakan pelbagai aktiviti dan program keagamaan. Malah PERTIS merupakan persatuan pertama yang mencetak al-Quran Braille di Malaysia (Rumiza Abdul Rahman, 2010). Ia telah mendapat pengiktirafan di peringkat kebangsaan daripada Kementerian Dalam Negeri (KDN) dan Jabatan Kemajuan Malaysia (JAKIM) dengan menerbitkan al-Quran Braille (Kod Braille Bahasa Arab Gred 1) yang bersumberkan al-Quran Braille terbitan Indonesia (Norakyairee Mohd Raus et al., 2013)

Rekod daripada United Nations Educational, Scientific and Cultural Organization (UNESCO) di bawah Persatuan Bangsa-bangsa Bersatu (PBB) berkaitan perkembangan kod Braille telah mencatatkan kod Braille bahasa Arab yang seragam dan kukuh mula diaplikasikan menjelang tahun 1960 (Kamel et al., 2008). Perkara ini dapat diandaikan bahawa seawal tahun 1950-an, kod Braille Bahasa Arab yang diaplikasikan di dalam al-Quran Braille di beberapa buah negara Islam di Timur Tengah. Ia turut disokong oleh PERTIS dengan menyatakan bahawa Mashaf al-Quran Braille yang pertama di bawa masuk ke Malaysia adalah pada tahun 1952 (Norakyairee Mohd Raus et al., 2013). Sekolah Kebangsaan Pendidikan Khas (SKPK)

Princess Elizabeth, Johor Bahru telah dianugerahkan hadiah senaskhah Mashaf al-Quran Braille daripada negara Jordan. Mashaf tersebut dicetak secara double sided dan mengandungi 6 jilid yang merangkumi 30 Juzuk. Maka, setiap jilid mengandungi 5 juzuk (Zakaria, 2008 & 2013). PERTIS juga turut memperoleh al-Quran Braille dari negara-negara lain seperti Mesir (1964), Tunisia (1976) dan Indonesia (1970). Kemunculan dan kewujudan mashaf al-Quran Braille di Malaysia telah menjadi titik permulaan kemajuan dan pengembangan pendidikan al-Quran Braille (Anisah Razali et al., 2022).

Berdasarkan analisis Norakyairee et al., (2013) dan Anisah Razali et al., (2022) dapat disimpulkan beberapa tarikh penting dan catatan berkaitan kronologi sejarah perkembangan Quran Braille di Malaysia. Secara amnya, kronologi ini bolehlah dibahagi kepada 5 fasa iaitu:

- 1) Fasa Penyalin al-Quran Braille
- 2) Fasa Pencetak al-Quran Braille
- 3) Fasa Penerbitan al-Quran Braille
- 4) Fasa Inovasi al-Quran Braille
- 5) Fasa Penambahbaikan al-Quran Braille

Tahun	Catatan
Fasa 1: Penyalin al-Quran Braille	
1980	Permulaan fasa proses penyalinan al-Quran Braille telah bermula.
1983	Penubuhan Jawatankuasa Kod Braille al-Quran al-Karim pada 9 September 1983 oleh Kementerian Pendidikan Malaysia (KPM) bertujuan menghasilkan Kod Braille al-Quran grade 2. Namun, usaha ini mendapat tentangan daripada komuniti OKU Penglihatan dan cetakan al-Quran Braille versi ini tidak dicetak.
1985	al-Quran Braille pertama yang lengkap berjaya disalin oleh Zahari Ghani dengan mengambil masa hampir tiga tahun berpandukan al-Quran Braille dari Indonesia. Kemudian dicetak menggunakan teknologi <i>Termoform</i> pada kertas <i>Brailion</i> . Satu salinan mengambil masa selama seminggu untuk disiapkan. Namun terdapat beberapa jilid telah hilang dalam simpanan setelah beliau kembali kerahmatullah.
1990-an	Usaha menyalin al-Quran Braille berkomputer oleh Muhammad Lee Abdullah dan Zakaria Yahya, masing-masing mengalami masalah penglihatan.
1994	Fasa proses pencetakan al-Quran Braille telah bermula oleh PERTIS sebelum proses semakan dijalankan.
1996	Kerjasama PERTIS dan JAKIM dalam menyemak al-Quran Braille.
1997	Proses semakan selesai dan didokumenkan dalam satu Laporan Jawatankuasa Kerja Penyemakan al-Quran Braille, Darul Quran JAKIM bertarikh 15 Oktober 1997.
Fasa 3: Penerbitan Quran Braille	
1998	Fasa proses penerbitan bermula dengan pengiktirafan al-Quran Braille cetakan PERTIS oleh JAKIM dan KDN.
	Penerbitan al-Quran Braille (grade 1) oleh PERTIS.
	Penerbitan buku Kod Wasilah Kod Braille al-Quran (grade 2) oleh KPM.

1999	Pada 7 Disember 1999, penerbitan al-Quran Braille (6 jilid) cetakan PERTIS dengan kerjasama Yayasan Pembangunan Ekonomi Islam Malaysia (YaPEIM) telah dilancarkan. Projek penerbitan ini yang bernilai RM50,000 telah dilancarkan oleh Menteri Perpaduan Negara dan Pembangunan Masyarakat, Datin Paduka Zaleha Ismail.
2006	Pengedaran al-Quran Braille cetakan PERTIS ke seluruh sekolah di Malaysia.
Fasa 4: Inovasi Quran Braille	
2009	Fasa inovasi al-Quran Braille bermula dengan termeterinya MoU antara PERTIS dan kumpulan penyelidik dari Fakulti Kejuruteraan Mekanikal (FKM), Universiti Teknologi Malaysia (UTM) dalam membangunkan Panel Al-Quran Braille Elektronik (eBraille al-Quran).
	Pembangunan <i>software</i> 'Smart Hafaz' untuk 10 juzuk pertama al-Quran oleh Sekolah Kebangsaan Pendidikan Khas (SKPK) Alma, Pulau Pinang. <i>Software</i> ini membantu Murid Berkeperluan Pendidikan Khas (MBPK) masalah penglihatan di sekolah tersebut dalam menghafaz al-Quran menggunakan teknik audio (dengar dan ulang).
2011	Panel al-Quran Braille Elektronik (eBraille al-Quran) yang mendapat dana daripada Kementerian Sains, Teknologi dan Inovasi (MOSTI) selesai dibangunkan dan panel tersebut diberi kepada PERTIS untuk kegunaan persatuan.
2012	Penubuhan Institut Quran Braille (IQBraille) sebagai salah satu Pusat Kecemerlangan (CoE) oleh USIM. Langkah pertamanya adalah menjalinkan hubungan kerjasama (MoU) dengan PERTIS dan UTM yang dimeterai pada 2 Mac 2012.
	Penerbitan buku Iqra (1-6) versi Braille oleh kumpulan penyelidik USIM dengan kerjasama PERTIS dan Bahagian Buku Teks, KPM. Naskhah ini telah diedarkan ke sekolah berkaitan di seluruh Malaysia
Fasa 5: Penambahbaikan al-Quran Braille	
2015	Penubuhan Jawatankuasa Quran Braille (JQB) oleh PERTIS bertujuan untuk menggerakkan usaha ke arah menyelaraskan kaedah penulisan al-Quran Braille sedia ada dengan Rasm Uthmani.
2017	JQB mendapat kerjasama Bahagian Penerbitan, JAKIM untuk menyediakan standard garis panduan al-Quran Braille.
2019	Usaha untuk menyediakan standard garis panduan al-Quran Braille mendapat kerjasama KDN seterusnya terbentuklah Jawatankuasa Penyediaan Standard Garis Panduan Penulisan Al-Quran Braille Malaysia.
2020	Standard Garis Panduan Penulisan Mashaf Al-Quran Braille Malaysia telah dapat disiapkan pada Mac 2020.
	Pada Mac 2020, proses penulisan MQBM bermula yang melibatkan 12 orang panel penulis yang terdiri daripada PERTIS, USIM dan Universiti Islam Pahang Sultan Ahmad Shah (UnIPSAS).
	Pada Ogos 2020, proses penulisan MQBM telah berjaya disempurnakan dan diikuti dengan proses semakan.

2021	Pada 22 Februari 2021, pelantikan Jawatankuasa Lajnah Tasheh Al-Quran Braille bagi sesi 2021-2022 telah disempurnakan. Proses semakan MQBM telah berjaya diselesaikan.
	Pada 27 Mac 2021, MQBM telah mendapat kelulusan daripada LPPPQ, KDN dengan nombor rujukan KDN.PKK.600-16/18/1.2/QA/873/41/2021(25:29).
2022	Pada 26 April 2022, MQBM berjaya diterbitkan dan dirasmikan oleh YB Senator Datuk Idris Ahmad, Menteri di Jabatan Perdana Menteri (Hal Ehwal Agama).

Seorang ustaz daripada SKPK Princess Elizabeth iaitu ustaz Sulaiman menerima sebuah naskhah al-Quran Braille daripada pihak yang tidak dikenalpasti. Beliau merasakan ia adalah satu anugerah buat MBPK masalah Penglihatan dan merasakan ia sebagai satu tanggungjawab. Beliau berusaha mempelajari sendiri dengan memahami dan menguasai kod Braille tersebut sehingga dapat mengajarkan kepada orang lain. Manakala pada awal tahun 1990-an, PERTIS pula telah mengambil inisiatif membantu dalam membuat semakan dan penyalinan semula al-Quran Braille dalam bentuk *soft copy* oleh cikgu Zakaria Yahya dan ustaz Muhammad Lee Abdullah. Mereka kedua-duanya adalah merupakan OKU Penglihatan.

Usaha mulia ini merupakan kesinambungan dari perjuangan beberapa rakan OKU Penglihatan bagi memastikan bahawa keperluan komuniti ini dalam pengajaran al-Quran tidak diabaikan. Teknologi komputer mesra OKU mula dihasilkan seawal 1990-an, seterusnya membolehkan mereka membangunkan kod Braille al-Quran berpandukan komputer. Pada tahun 1994, Kejayaan terbesar dalam dunia OKU Penglihatan telah direkodkan apabila terhasilnya al-Quran Braille dengan menggunakan kod Braille komputer. Ia adalah hasil usaha kerjasama Cikgu Zakaria Yahya dan Ustaz Muhammad Lee Abdullah.

Menurutkan ustaz Muhammad Lee Abdullah, beliau mengambil masa selama tiga bulan bagi menukarkan kod Braille al-Quran daripada Indonesia kepada Kod Braille berkompuser. Beliau mempelajari secara sendiri bagaimana kaedah menukarkan kod aksara papan kekunci komputer kepada kod Braille menggunakan perisian Duxbury Translator (DBT). Seterusnya akan dicetak menggunakan *Embosseser* iaitu mesin pencetak Braille. Semakan selama empat tahun telah dibuat bersama JAKIM dengan menyemak bacaan dan tanda bacaan. Akhirnya, al-Quran Braille telah berjaya diluluskan penerbitannya pada tahun 1998. (Noornajihan Jaafar & Kauthar Abdul Kader, 2008; Norakyairee Mohd Raus et al., 2013).

Pada tahun yang sama, sebuah buku berjudul "Kod Braille Wasilah Bacaan al-Quran" telah diterbitkan oleh Dewan Bahasa dan Pustaka. Buku tersebut dihasilkan oleh Jawatankuasa Kod Braille al-Karim di bawah pengawasan KPM. Pembangunan buku ini telah bermula sejak tahun 1983. Kod Wasilah merupakan sistem penulisan Quran grade 2 iaitu sistem penulisan secara ringkas dimana huruf dan baris tidak lagi ditulis secara terpisah, tetapi disatukan dengan tanda-tanda khas. Namun sehingga kini, buku tersebut belum dapat dipraktikkan kerana terdapat beberapa kekangan yang menyukarkan OKU Penglihatan untuk memahami dan menguasainya.

Pada tahun 2019, fasa penambahbaikan mashaf al-Quran Braille telah bermula. Sebuah jawatankuasa telah dibangunkan di bawah KDN dengan kerjasama erat JAKIM bagi membangunkan satu Garis Panduan Penulisan Al-Quran Braille Standard Malaysia. Panel khas yang terlibat terdiri daripada pakar-pakar al-Quran dan Braille dari USIM dan PERTIS. Ciri

utama penggubalan Garis Panduan Standard Penulisan Al-Quran Braille ini adalah menjurus kepada standard penulisan mengikut kaedah *Rasm Uthmani*, tidak seperti mana penulisan al-Quran Braille lain yang cenderung kepada kaedah penulisan Imla'i (KDN, 2021).

Hasil daripada garis panduan tersebut, JAKIM dengan kerjasama PERTIS telah berjaya menerbitkan al-Quran Braille yang lebih hampir dengan *Rasm Uthmani* dan kaedah penulisan mashaf al-Quran bercetak dan dinamakan sebagai Mashaf al-Quran Braille Malaysia (MQBM). MQBM berjaya dihasilkan dan telah mendapat kelulusan daripada Lembaga Pengawalan dan Pelesenan Pencetakan Teks Al Quran (LPPPQ), KDN (Noornajihan Jaafar et al., 2022). Pada 26 April 2022, MQBM berjaya diterbitkan dan sempurna dilancarkan oleh YB Senator Datuk Idris Ahmad, Menteri di Jabatan Perdana Menteri (Hal Ehwal Agama).

Rentetan daripada pembangunan MQBM ini, telah terhasil juga sebuah modul pengajaran terbitan USIM berjudul Modul Pengajaran Mashaf Al-Quran Braille Malaysia. Tujuan modul ini adalah untuk menyelaras dan menyebarkan kefahaman dan penguasaan kumpulan sasar berkaitan kaedah baharu penulisan al-Quran Braille Standard Malaysia berasaskan *Rasm Uthmani*. Malah, ia juga bertujuan menjadi rujukan dan panduan bagi meningkatkan kefahaman dan tahap penguasaan pengguna terhadap pengajaran dan pembelajaran al-Quran Braille Malaysia (Noornajihan Jaafar et al., 2022).

MASHAF AL-QURAN BRAILLE MALAYSIA

Latar Belakang Mashaf Al-Quran Braille Malaysia

Mashaf Al-Quran Braille Malaysia (MQBM) telah berjaya diterbitkan pada tahun 2022 dan dirasmikan oleh Menteri di Jabatan Perdana Menteri (Hal Ehwal Agama), YB Senator Datuk Idris Ahmad. MQBM ini dihasilkan dengan melihat aspek rasm dan dabt yang ditranskripsi sehampir mungkin dengan mashaf al-Quran bercetak (*Rasm Uthmani*). Ia berpandukan Mashaf al-Quran bercetak terbitan Mujamma' Malik Fahd, Arab Saudi (Mashaf Madinah). Walau bagaimanapun kaedah penulisan *Rasm Imlai* turut diguna pakai apabila terdapat kekangan dalam kaedah penulisan dan pembacaan al-Quran Braille ini.

Sebelum ini, Mashaf al-Quran Braille yang diterbitkan oleh PERTIS adalah kebanyakannya berpandukan kepada teks al-Quran Braille terbitan Yayasan Kesejahteraan Tunanetra Islam (YAKETUNIS), Jogjakarta Indonesia. Sistem penulisannya adalah berasaskan *Rasm Imlai* (Muhammad Mustaqim, 2014). Sistem penandaan (dabt) yang diaplikasi sebelum ini tidak selaras dengan sistem dabt yang diaplikasi dalam mashaf terbitan Mujamma' Malik Fahd (Mohd Nur Adzam et al., 2021). Situasi ini berlaku kerana negara Malaysia mempunyai kekurangan kemahiran dan kepakaran ilmu penulisan al-Quran Braille ketika itu. Kewujudan mashaf al-Quran Braille terbitan PERTIS sememangnya sangat membantu dalam memberi peluang kepada komuniti OKU penglihatan untuk berdamping dan membaca al-Quran. Namun begitu, terdapat beberapa isu yang telah timbul antaranya pengguna mashaf Braille tidak dapat menggunakan silibus pembelajaran yang sama dengan pelajar tipikal kerana bentuk rasm dan dabt yang berbeza antara dua mashaf (Mohd Nur Adzam Rasdi et al., 2017). Ini turut menjadi penghalang ke arah pendidikan inklusif. Perbezaan ini juga turut membuatkan OKU penglihatan ketinggalan dari aspek memahami ilmu penulisan mashaf al-Quran.

Oleh itu, penghasilan MQBM telah menyelaraskan penulisannya sehampir mungkin antara mashaf al-Quran Braille dengan mashaf al-Quran bercetak bagi tujuan pemeliharaan teks al-Quran dan pembaca al-Quran dari kalangan OKU penglihatan akan berpeluang untuk





























mendalami ilmu penulisan al-Quran dengan jelas, seterusnya menghapuskan *double standard* atau jurang perbezaan antara golongan tipikal dan OKU penglihatan.

Kod Mashaf Al-Quran Braille Malaysia (MQBM)









Dalam MQBM, struktur peletakan huruf dan tanda bacanya mempunyai perbezaan dengan mashaf al-Quran bercetak. Kedudukan mashaf al-Quran bercetak adalah tanda baca diletakkan di atas atau di bawah huruf *hijaiyyah* manakala tanda baca bagi mashaf al-Quran Braille pula, secara berselang-seli antara huruf dan baris.

Terdapat beberapa penambahbaikan dilakukan dalam penulisan al-Quran sebelum ini dengan MQBM. Antara penambahbaikan bagi rasm adalah kod hamzah di bawah alif () iaitu kod (4,6) (:). Al-Quran Braille sebelum ini menggunakan kod (3,4) (:) untuk menandakan hamzah di atas dan bawah alif. Manakala bagi dabt pula ialah penambahan dan penyelarasan semula pada *Tanwin al-Itba'* (tanwin tidak selari), *Sifr Mustadir*, *Sifr Mustatil*, *Tashil*, *Imalah*, *Sajdah*, *Saktah*, *Iqlab*, nun kecil, sin kecil dan tanda *Waqf*. Kod huruf *hijaiyyah* di dalam MQBM mengandungi 35 huruf manakala tanda baca mengandungi 22 tanda baca (tidak termasuk tanda *waqf* selain *waqf taanuq*). Berikut adalah tanda kod bagi huruf *hijaiyyah* dan tanda baca:





















HURUF ASAS QURAN (RASM)

									
ا	ب	ت	ث	ج	ح	خ	د	ذ	ر
									
ز	س	ش	ص	ض	ط	ظ	ع	غ	ف
									
ق	ك	ل	م	ن	و	ه	ي		

HURUF TAMBAHAN

									
ء	أ	إ	ؤ	ئ	ى	ة			

TANDA BACA (DABT)

									
⠠	⠡	⠢	⠣	⠤	⠥	⠦	⠧	⠨	⠩
									
⠠	⠡	⠢	⠣	⠤	⠥	⠦	⠧	⠨	⠩

WAQF TAA'NUQ MAD ALIF KECIL YA KECIL WAW KECIL MIM IQLAB IMALAH/ISTMAM TASHIL SIFR MUSTADR SIFR MUSTATL

FORMAT PENULISAN MASHAF AL-QURAN BRAILLE MALAYSIA

Format penulisan yang diaplikasikan di MQBM adalah seperti berikut:

- Penulisan Quran Braille tulisan Braille hanya ditulis dan dicetak dari satu arah iaitu dari kiri ke kanan sahaja.
- Halaman pertama setiap jilid MQBM mengandungi isi kandungan mashaf yang menyatakan nama surah dan nombor halamannya.
- Di awal setiap surah dinyatakan maklumat berkaitan surah tersebut iaitu nama surah, nombor surah, status penurunan surah (*Makkiah* atau *Madaniah*) dan bilangan ayat dalam surah tersebut.

- Di dalam teks al-Quran Braille hampir setiap huruf ditulis secara berselang seli dengan harakat dalam satu barisan kalimah yang sama. Ini berbeza dengan apa yang diaplikasi pada teks asal mashaf di mana harakat ditulis sama ada di atas atau di bawah huruf.
- Setiap permulaan ayat al-Quran pada sesuatu baris mestilah dimulakan dengan perenggan baru.
- Muka surat mashaf al-Quran Braille tidak sama dengan mashaf al-Quran bercetak. Ia terletak di bahagian atas kanan. Namun nombor muka surat bercetak juga turut disertakan pada bahagian atas kiri bagi memudahkan pengguna MQBM mencari muka surat yang diperlukan terutamanya semasa bertadarus atau bertalaqi dengan rakan-rakan yang menggunakan mashaf al-Quran bercetak.
- Pembahagian jilid, bagi satu mashaf al-Quran bercetak mengandungi 30 juzuk. Oleh kerana MQBM mempunyai banyak muka surat berbanding dengan mashaf al-Quran bercetak, maka ia harus dibahagikan kepada 6 jilid. Setiap jilid mengandungi 5 juzuk seperti berikut:

Jilid	Surah
Jilid 1	Surah <i>Al-Fatihah</i> (1) – Surah <i>Al-Nisa'</i> (4).
Jilid 2	Surah <i>Al-Ma'idah</i> (5) – surah <i>At-Taubah</i> (9).
Jilid 3	Surah <i>Yunus</i> (10) – Surah <i>Maryam</i> (19).
Jilid 4	Surah <i>Taha</i> (20) – Surah <i>Luqman</i> (31).
Jilid 5	Surah <i>As-Sajdah</i> (32) – Surah <i>Al-Fath</i> (48).
Jilid 6	Surah <i>Al-Hujurat</i> (49) – Surah <i>An-Nas</i> (114).

KESIMPULAN DAN CADANGAN

Secara keseluruhan, kajian ini berkisar mengenai sejarah perkembangan al-Quran Braille di Malaysia dan pengenalan latar belakang MQBM. Penghasilan MQBM telah membuka peluang yang lebih luas kepada OKU Penglihatan dalam mempelajari al-Quran mengikut mashaf al-Quran bercetak (*Rasm Uthmani*). Pemahaman terhadap latar belakang OKU Penglihatan dan kemahiran dalam menguasai sistem tulisan Braille menjadi langkah pertama ke arah mengeratkan hubungan dan kerjasama antara komuniti OKU penglihatan dan golongan tipikal terutamanya dalam aspek penghayatan dan pengamalan agama yang bermula dengan pembacaan al-Quran yang betul dan sempurna. Diharapkan kajian ini, memberi makna yang berharga terutamanya kepada komuniti OKU Penglihatan kerana dapat memberikan kefahaman kepada golongan masyarakat, sama ada yang tipikal mahupun OKU Penglihatan terhadap mashaf al-Quran Braille Malaysia. Seterusnya berupaya membawa kepada perkembangan aspek penyelidikan dalam bidang tersebut yang lebih cerah pada masa akan datang.

PENGHARGAAN

Kertas ini membentangkan kajian keperluan yang disokong oleh geran kerjasama Universiti Sains Islam Malaysia (Matching Grant): (USIM/MG/PERTIS/FPQS/SEPADAN-S/71021).

RUJUKAN

- Anisah Razali, Noornajihan Jaafar & Mohd Nur Adzam Rasdi. (2022). Penerokaan Pendidikan Al-Quran bagi Murid Berkeperluan Khas Masalah Penglihatan. *eProsiding Wacana Pendidikan Islam Siri ke-12*. e ISBN 978-967-2224-72-3
- Ahmad Jaeni (2017) Rasm Usmani Dalam Penulisan al-Qur'an Braille, Model dan Aplikasinya dalam Mushaf Standar Braille.
- Mohd Nur Adzam, Muhammad Yusry Affandy Md Isa, Noornajihan Jaafar, Khairul Anuar Mohamad & Norakyairee Mohd. Raus (2021). Implikasi Ketiadaan Sifr Mustadīr ke atas Pentilawah Al-Quran Braille: Implikasi Ketiadaan Sifr Mustadīr pada Tilawah Al-Quran Braille. *Jurnal Pendidikan Al-Quran Sunnah & Keperluan Khas*, 5 (1), 14-26.
- Mohd Nur Adzam Rasdi, Noornajihan Jaafar, Khairul Anuar Mohamad, Nur Badriah Omar, Norakyairee Mohd Raus, Mahyuddin Hashim & Siti Rahmah Ahmad Razuan (2017). Iqra Braille Sebagai Modul Asas Pengajaran Dan Pembelajaran Tilawah Al-Quran Braille: Isu Ketidakeragaman Antara Dua Teks. *Journal of Quran Sunnah Education & Special Needs*.
- Mohd Nur Adzam Rasdi et al. (2017). Aplikasi Dhabṭ al-Quran dalam penulisan Quran Braille: Perbandingan antara Mashaf Braille PERTIS dengan Muṣḥaf Madīnah al-Munawwarah. *Seminar al-Quran Braille*. PERTIS. Kuala Lumpur.
- Muhammad Mustaqim Mohd Zarif. Buku Braille. (2013). *Al-Quran : Sejarah dan Kaedah*. Penerbit Universiti Sains Islam Malaysia. ISBN 978-967-440-005-7
- Muhammad Mustaqim Mohd Zarif Abdul Qadir, Umar Usman Al-Hamidy & Noornajihan Jaafar. (2013). *Pembangunan Braille al-Quran Rasm Uthmani*. Universiti Sains Islam Malaysia.
- Noornajihan Jaafar, Norakyairee Mohd Raus, Mohd Nur Adzam Rasdi, Amalina Azhar & Anisah Razali. (2022). *Modul Pengajaran Mashaf Al-Quran Braille Malaysia*. Penerbit Universiti Sains Islam Malaysia.
- Noornajihan Jaafar, & Kauthar Abdul Kader. (2008). Pengajaran Braille al-Quran di Malaysia. *Seminar Warisan Quran Dan Hadith Nusantara*.
- Norakyairee Mohd Raus, Mohd Nur Adzam Rasdi, Norazman Alias, Norhasnira Ibrahim, Norullisza Khosim, & Jaafar, N. (2013). Pengajaran al-Quran Braille: Isu dan Cabaran Semasa. *International Journal on Quranic Research (IJQR)*, 3(4), 79–94.
- Rumiza Abdul Rahman. (2010). *Pengajian al-Qur'an dalam kalangan ahli Persatuan Orang-orang Cacat Penglihatan Islam Malaysia (PERTIS), di Kuala Lumpur dan Kuala Terengganu*. Akedemi Pengajian Islam Universiti Malaya Kuala Lumpur.
- Yunardi, E. B. (2012). Sejarah Mushaf Al-Quran Standar Braille Penelusuran Awal. *SUHUF*, 5(2), 255-270.
- Zakaria Yahya. (2008). Perkembangan dan Isu Terkini dalam Penulisan al-Quran Braille: Satu Tinjauan Umum. *Seminar Perkembangan Dan Isu Terkini Dalam Penulisan Al-Quran Braille (p. 14)*. Kuala Lumpur: PERTIS.

Tuan Guru Haji Ahmad Fuad Bin Hassan: Tokoh Politik Islam Sebelum Merdeka

Mohd Fadli Ghani
Institut al-Balaghul Mubin

ABSTRAK

Pergerakan politik Islam telah mengalami kebangkitan di Tanah Melayu selepas Perang Dunia Kedua, iaitu berselang dua dekad selepas kejatuhan Khilafah Othmaniyah pada 1924. Bibit-bibit awal kebangkitan ini bermula dengan kemasukan pengaruh Sarekat Islam pada dekad 1920-an, kemudian membawa kepada penubuhan Hizbul Muslimin dan Persatuan Islam Se-Malaya (PAS) selepas Perang Dunia Kedua. Salah seorang tokoh ulama yang terpenting dalam kebangkitan ini ialah Tuan Guru Haji Ahmad Fuad Hassan (1915-1966) yang berasal dari Perak, tetapi bergerak cergas di Terengganu dan Pulau Pinang. Beliau pernah memegang jawatan Pesuruhjaya Agama Terengganu dan menjadi Ahli Majlis Penasihat Islam Pulau Pinang dan Seberang Perai, selain merupakan ulama pertama yang dilantik menganggotai Majlis Undangan Persekutuan pada 1951. Selain terlibat dengan PASPAM dan PESAKA, Tuan Guru Haji Ahmad Fuad adalah pengasas kepada PAS, parti Melayu Islam yang paling berpengaruh hari ini. Kajian ini bertujuan untuk menggali latar belakang dan biografi politik Tuan Guru Haji Ahmad Fuad Hassan dan aktivismenya dalam gerakan Islam di negara ini.

PENGENALAN

Kebangkitan semula gerakan politik Islam pasca Ordinan Darurat 1948 telah bermula dengan tindakan Tuan Guru Haji Ahmad Fuad Hassan menubuhkan PAS – sebuah pertubuhan politik Islam – dalam Persidangan Alim Ulamak Malaya anjuran Umno pada 23 Ogos 1951. Haji Ahmad Fuad Hassan adalah satu nama besar dalam kepemimpinan politik Melayu, perjuangan kemerdekaan dan gerakan Islam selepas dunia kedua. Pengalamannya di Gunung Semanggol telah menjadikannya seorang aktivis sosial di Terengganu dan Pulau Pinang, sebelum muncul sebagai tokoh politik Islam dengan memimpin Bahagian Agama Umno dan mencipta nama menerusi pengasasan PAS. Yang Dipertua Agung PAS yang pertama ini, selain mengendalikan Madrasah al-Masriyah sebagai mudir, beliau juga merupakan ulamak yang pertama menganggotai Majlis Undangan Persekutuan, sebelum terlibat dalam perniagaan di sektor pengangkutan dan persuratkhabaran.

LATAR BELAKANG KELUARGA

Tuan Guru Haji Ahmad Fuad Hassan atau nama sebenarnya Dahmat bin Hassan bin Bilal Mat Salleh telah dilahirkan dalam sebuah keluarga petani miskin yang kuat beragama di Kampung Ulu Piol, Manong, Kuala Kangsar, Perak pada 1916⁶¹. Beliau merupakan anak keenam daripada sembilan beradik anak-anak Hassan bin Bilal Mat Salleh dan Hajah Rahmah binti Ngah Abdullah. Kedua-dua orang tuanya berasal dari Gopeng Parit, Manong. Ketika beliau berusia 10 tahun, ayahnya, Hassan telah meninggal dunia sehingga Dahmat terpaksa berhijrah ke Sitiawan untuk tinggal bersama bapa saudaranya, Haji Tahir Ngah Abdullah selama tiga

⁶¹ Tarikh sebenar kelahiran beliau tidak dapat dipastikan. Menurut John N Funston (1976), Haji Ahmad Fuad dilahirkan pada 1910, tetapi buku Cenderamata Sempena Ijtimak Madrasah al-Masriyah (1973) mendakwa beliau dilahirkan pada 1915. Kajian Radziah Sulong (1987) yang mengutip maklumat daripada keluarga terdekat tokoh ini pula mendakwa beliau dilahirkan pada 1916. Tetapi menurut Dr Haji Abbas Alias, Haji Ahmad Fuad adalah juniornya yang hampir sebaya di ACS Sitiawan. Oleh kerana Dr Haji Abbas lahir dalam tahun 1914, maka tahun kelahiran yang lebih tepat bagi Haji Ahmad Fuad ialah 1915 atau 1916.

tahun. Pada 1928, beliau kembali ke Manong untuk hidup bersama ibunya di kampung kelahirannya.

MENDAPAT ASUHAN TOKOH-TOKOH GERAKAN ISLAM

Kemiskinan dan kesempitan hidup tidak menghalang Dahmat atau kemudiannya dikenali sebagai Ahmad Fuad, untuk membina kehidupan yang cemerlang. Setelah mendapat didikan awal daripada orang tuanya, pada 1923 beliau dihantar belajar di Sekolah Melayu Semat, Manong untuk mendapat pendidikan formal. Tiga tahun belajar di sekolah ini, beliau terpaksa berhijrah ke Sitiawan setelah bapanya meninggal dunia. Di Sitiawan, beliau dihantar oleh bapa saudaranya ke Anglo Chinese School, Sitiawan, sebuah sekolah Inggeris yang dibina oleh mubaligh Kristian. Di sekolah inilah beliau berkenalan dengan Dr Haji Abbas Alias, seorang pelajar senior yang kemudian menjadi sahabat karibnya. Beliau tidak menghabiskan pengajian di sekolah ini yang sepatutnya berakhir di Darjah (Standard) Tujuh kerana tidak tahan dengan kegiatan agama Kristian. Pada 1928 beliau berhenti daripada sekolah ini ketika berada di Darjah Lima.

Beliau kemudian kembali semula ke Manong untuk meneruskan pengajiannya di bidang agama dengan memasuki Madrasah al-Arabiyah al-Mariyah, Bukit Chandan, Kuala Kangsar. Beliau mulai mendalami ilmu-ilmu asas Islam dan bahasa Arab. Di sekolah ini beliau menjadi rakan Ustaz Zabidi Ali, seorang tokoh gerakan Islam yang bergerak bersama-samanya kemudiannya. Setelah lulus di madrasah ini pada 1931, beliau diterima belajar di Madrasah Idrisiah, Bukit Chandan, sebuah sekolah agama yang terkenal di Perak ketika itu. Di madrasah ini beliau mendalami bahasa Arab, selain ilmu-ilmu Islam seperti usuluddin, fiqh dan tasawuf. Antara guru beliau yang terkenal di madrasah ini ialah Sheikh Abdullah Fahim (kemudiannya Mufti Pulau Pinang), Sheikh Abu Bakar al-Baqir (pengasas Hizbul Muslimin) dan Sheikh Hassan bin Said Yamani (kemudiannya Mufti Terengganu). Di madrasah ini juga beliau belajar bersama-sama dengan Ustaz Zabidi Ali.

Apabila gurunya, Sheikh Abu Bakar al-Baqir menubuhkan Maahad Il Ihya As-Syarif di Gunung Semanggol pada 1934, beliau terus berhijrah ke Gunung Semanggol untuk mendalami agama di peringkat yang lebih tinggi. Di maahad ini, beliau terus memasuki kelas Qismu al-Ali, iaitu kelas tertinggi yang setaraf dengan pengajian kolej dan Senior Cambridge bagi pengajian Inggeris. Setelah tiga tahun setengah di Gunung Semanggol, beliau berjaya menjadi pelajar pertama Maahad Il Ihya yang lulus sijil Qismu al-Ali. Sebagai pelajar cemerlang di maahad tersebut, beliau telah diberikan gelaran al-Bariaq oleh gurunya, Sheikh Abu Bakar al-Baqir. Semenjak itu, beliau dikenali sebagai Dahmat al-Bariaq. Ketika di maahad ini juga beliau telah belajar bersama-sama Ustaz Ahmad Maliki, Ustaz Othman Hamzah, Ustaz Baharuddin Latif, Ustaz Ahmad Mahir dan lain-lain yang menjadi tokoh gerakan Islam selepas merdeka.

Kerana kecemerlangan akademiknya, beliau telah mendapat biasiswa daripada Maahad Il Ihya untuk melanjutkan pengajian dalam bidang Ulum Syariah dan Fiqh Islamiyah di Masjidil Haram, Mekah pada 1937. Semasa dalam pelayaran ke Mekah, beliau telah bersahabat baik dengan bekas gurunya, Sheikh Hassan Yamani. Ketika di Mekah, beliau berguru dengan Sheikh Hassan Yamani dan beberapa guru lain. Beliau juga tinggal bersama Sheikh Hassan Yamani sebagai anak angkat kepada ulamak tersebut. Nama beliau kemudian oleh gurunya kepada Ahmad Fuad menggantikan nama Dahmat kerana kebolehan dan ilmu yang dimilikinya. Sehingga akhir hayat, nama Ahmad Fuad digunakan oleh beliau. Pada 1939, beliau telah menamatkan pengajian dan mengikut bapa angkatnya untuk kembali ke Tanah

Melayu. Beliau kemudian mengikuti pengajian tidak rasmi di rumah Sheikh Hassan Yamani di Terengganu antara 1940 hingga 1950 melalui kuliah umum. Beliau juga dikatakan pernah belajar di Madrasah al-Masriyah, Bukit Mertajam di bawah pimpinan Tuan Guru Haji Salleh al-Masri, yang juga mertuanya.

TOKOH PENDIDIK DAN PENTADBIR ULUNG

Sebaik sahaja pulang ke Perak pada 1939, beliau menjalankan amanah pertamanya iaitu menjadi guru di Maahad Il Ihya, iaitu pihak yang membiayai pengajiannya di Mekah. Tetapi di atas permintaan Sheikh Hassan Yamani, beliau telah dipinjamkan ke Madrasah Idrisiah, Kuala Kangsar antara 1939 hingga 1941. Di samping itu, beliau tetap menjadi guru sambilan di Madrasah Il Ihya. Sebelum ke Mekah, beliau adalah guru pembantu maahad tersebut selama tiga tahun. Walau bagaimanapun, tugas beliau sebagai guru di kedua-dua pusat pengajian Islam tersebut berakhir apabila beliau berhijrah ke Terengganu pada akhir 1941 kerana mengikuti gurunya, Sheikh Hassan Yamani yang dilantik sebagai Mufti Terengganu.

Di Terengganu, beliau yang tinggal bersama bapa angkatnya itu telah dilantik sebagai Pembantu Khas kepada Mufti Terengganu selama tiga tahun. Pada 1943, beliau telah dilantik sebagai Pemangku Pesuruhjaya Agama Terengganu selama sebulan di samping menjalankan tugas sebagai Penyelia atau Nazir Sekolah-sekolah Agama di Jabatan Agama Negeri Islam Terengganu semenjak 1941 hingga 1951. Selain berkhidmat sebagai pegawai agama di Terengganu, Haji Ahmad Fuad juga telah berkhidmat secara sambilan sebagai pendidik. Pada 1947, beliau telah menjadi 'Pembaca Kitab' di Nadil Huda, iaitu sebuah kelas agama umum yang dipimpin oleh Sheikh Hassan Yamani. Di samping itu juga, beliau turut menjadi Nazir di Maahad Tengku Embong Fatimah antara 1947 hingga 1951 dan menjadi guru di Tahdir Muallimat, sebuah kelas persediaan perguruan untuk para pelajar perempuan yang berminat menjadi guru.

Selain menjadi guru di beberapa institusi pengajian agama, jasa yang lebih besar dicurahkan oleh Haji Ahmad Fuad ialah mengasaskan beberapa institusi pendidikan Islam. Pada 1942, dengan pengaruh yang dimiliki sebagai Nazir Sekolah Agama Terengganu, beliau telah menubuhkan Madrasah al-Khairiyah di Hiliran, Kuala Terengganu. Madrasah itu kini dikenali sebagai Sekolah Agama Khairiyah. Pada 1947 pula, beliau telah mengasaskan Maahad Tengku Embong Fatimah, Kuala Terengganu sebagai sebuah kelas agama swasta sambilan berbayar. Bagi membantu masyarakat awam mendalami ilmu agama, dengan bantuan Mufti Terengganu, beliau menubuhkan kelas Nadil Huda pada 1947 yang mengadakan kelas secara 'menadah kitab'.

Oleh kerana beberapa sekolah agama di Terengganu menghadapi masalah kekurangan guru, terutama guru-guru wanita, Haji Ahmad Fuad telah menubuhkan sebuah maktab perguruan wanita yang dinamakan Tahdir Muallimat pada 1948 yang menyediakan kelas persediaan perguruan kepada pelajar-pelajar wanita cemerlang. Di samping itu juga, Haji Ahmad Fuad turut menubuhkan kelas pra-sekolah untuk anak-anak yang berusia antara enam hingga tujuh tahun yang dikenali sebagai Kelas Permulaan juga pada 1948. Tetapi malangnya, semua institusi pengajian Islam ini kecuali Madrasah al-Khairiyah terpaksa ditutup pada 1951 apabila Haji Ahmad Fuad berhijrah ke Seberang Perai. Institusi-institusi ini menghadapi masalah pentadbiran dan kekurangan guru, selain terpaksa bersaing dengan sekolah-sekolah lain lebih terkenal.

Pada 1951, Haji Ahmad Fuad telah dijemput oleh mertuanya, Tuan Guru Haji Salleh al-Masri untuk membantunya membangunkan Madrasah al-Masriyah yang diasaskannya semenjak 1906. Setelah berkhidmat sebagai guru selama dua tahun di Madrasah al-Masriyah, beliau diberikan kepercayaan untuk menjadi mudir madrasah tersebut pada 1953. Sebaik sahaja menjadi mudir, beliau telah memperkenalkan sistem pengajian berkelas atau nizami di madrasah itu. Beliau juga telah menubuhkan kelas menengah (thanawi) di Madrasah al-Masriyah pada 1958, selain menubuhkan cawangan Madrasah al-Masriyah yang dikenali sebagai Masriyah English Secondary School pada 1958 untuk membolehkan membolehkan para pelajarnya mengambil peperiksaan kerajaan termasuk Lower Certificate of Education (LCE). Beliau menjadi mudir madrasah ini sehingga 1966.

Selain bergiat cergas dalam dunia pendidikan, Haji Ahmad Fuad juga merupakan seorang penulis yang aktif. Dalam kesibukan beliau bergiat sebagai ahli politik dan pendidik, beliau sempat menghasilkan empat buah buku iaitu *Mahkota Kesopanan* (tasawuf), *Pedoman Pidato* (komunikasi), *Lailatul Qadar* (aqidah) dan *Bidayah Hidayah* (aqidah dan tasawuf). Beliau juga turut menterjemahkan sebuah kitab hadis, *Sahih Bukhari* ke bahasa Melayu, serta turut menulis syair dan rencana tentang pembangunan umat Islam di *Utusan Melayu*, *Suara Umno* dan *Warta Negara*. Antara tulisan beliau yang penting ialah ‘*Untuk Kasihkan Allah*’, satu rencana tasawuf; ‘*Menyatukan Pentadbiran Agama Islam*’ tentang pembangunan politik Islam; dan ‘*Ulamak Malaya Belum Bersatu dan Belum Mempunyai Persatuan*’ tentang perpaduan ulamak.

Di samping itu juga, mulai awal 1960-an Haji Ahmad Fuad mula menceburi dunia perniagaan. Pada 1960, beliau telah menguasai saham terbesar dalam sebuah syarikat pengangkutan di Seberang Perai dan dilantik menjadi Pengerusi Lembaga Pengarah syarikat tersebut. Syarikat ini menjadi pengedar *Utusan Melayu* untuk wakil-wakil akhbar itu di Utara Semenanjung. Menjelang 1962, syarikat tersebut telah menguasai sejumlah saham dalam *Utusan Melayu* yang menyebabkan Haji Ahmad Fuad dilantik sebagai Ahli Lembaga Pengarah *Utusan Melayu* mewakili syarikatnya. Pada 1964, apabila *Utusan Melayu* membeli *Warta Negara* daripada Maktabah Haji Abdullah Nordin Arrawi milik Haji Yusof Rawa, Haji Ahmad Fuad ditugaskan untuk mengetuai *Warta Negara* sehingga 1966 sebagai Pengerusi Lembaga Pengurusan.⁶²

ULAMAK NASIONALIS

Melalui zaman remaja sebagai pelajar kepada beberapa ulamak tokoh nasionalis seperti Sheikh Abdullah Fahim dan Ustaz Abu Bakar al-Baqir telah mendedahkan Haji Ahmad Fuad kepada gerakan nasionalisme. Pemikiran dan aktivisme golongan muda yang ketika itu sedang rancak berkembang di Pulau Pinang turut dirasai oleh beliau khususnya tentang gagasan-gagasan pembebasan daripada belunggu penjajah. Perkembangan sekeliling ini telah mendorong Haji Ahmad Fuad untuk turut terlibat sama dalam beberapa kegiatan separa politik untuk menentang penjajah dengan rangsangan daripada guru-gurunya itu. Para pelajar ketika ini digalakkan melanggan akhbar, menyertai persatuan-persatuan dan juga menulis rencana-rencana isu semasa untuk diterbitkan oleh akhbar-akhbar.

Penglibatan secara terbuka Haji Ahmad Fuad bermula apabila beliau berhijrah ke Gunung Semanggol pada 1934. Oleh kerana Ustaz Abu Bakar al-Baqir menggalakkan pelajar-

⁶² Kisah Haji Ahmad Fuad di *Warta Negara*, sila lihat Subky Abdul Latif (2013), *Propagandis Zaman, Kemilau Publika*, Kuala Lumpur, hal. 110-114.

pelajarnya terlibat dengan pertubuhan-pertubuhan agama dan separa politik serta melanggan akhbar-akhbar yang wujud ketika itu, para pelajar dengan cepat terdedah kepada perkembangan politik semasa. Kebanyakan pelajar Maahad Il Ihya termasuk Haji Ahmad Fuad ketika itu menjadi ahli Persatuan Melayu Perak, Persatuan Sun Light Taiping, Kelab Saadah Kuala Kangsar dan Persaudaraan Sahabat Pena Malaya (PASPAM). Haji Ahmad Fuad terlibat dengan aktif dalam PASPAM dan dilantik sebagai Setiausaha PASPAM Cawangan Gunung Semanggol pada 1935 hingga 1937. Selain itu juga, Ahmad Fuad turut menerima latihan politik dan kepemimpinan melalui kegiatan syarahan dan perdebatan serta menulis di akhbar-akhbar seperti *Utusan Melayu*, *Warta Negara* dan *Warta Kinta*.

Penghijrahan Haji Ahmad Fuad ke Mekah pada 1938 telah menamatkan kegiatan beliau di Maahad Il Ihya, tetapi memulakan penglibatan beliau dalam beberapa gerakan pelajar di Mekah. Tumpuan utama di Mekah pada ketika itu ialah masalah penjajahan Palestin oleh British selepas kejatuhan Kerajaan Othmaniyah. Ahmad Fuad merupakan pendukung kepada perjuangan beberapa kumpulan pemuda Arab di Mekah termasuk kumpulan al-Badawi yang berjuang untuk membebaskan tanah suci Baitul Maqdis. Ahmad Fuad juga turut bergiat dalam Persatuan Melayu Hijaz, sebuah persatuan pelajar-pelajar Melayu yang menjaga kebajikan pelajar di Mekah. Melalui persatuan ini, semangat nasionalisme dibina di kalangan pelajar khususnya untuk membebaskan Nusantara daripada penjajah.

Setelah kembali ke Tanah Melayu pada 1939, Ahmad Fuad lebih memberikan tumpuan kepada kegiatan perguruannya, sehinggalah beliau dilantik menjadi Pemangku Pesuruhjaya Agama Terengganu pada 1943. Kerana kedudukan beliau yang dihormati di Terengganu pada zaman Jepun, beliau telah dipilih mewakili Majlis Agama Islam Terengganu bersama Mufti Sheikh Hassan Yamani ke Persidangan Majlis Agama Malai-Sumatera anjuran Pejabat Penasihat Adat Istiadat dan Kebudayaan Melayu Markaz Pentadbiran Tentera Jepun yang berlangsung di Istana Iskandariah, Kuala Kangsar pada 12 Disember 1944. Persidangan yang diselia oleh Dr Burhanuddin al-Helmy ini berjaya menubuhkan Majlis Agama Serantau bagi menyelaraskan beberapa kegiatan agama umat Islam termasuk puasa, hari raya, fatwa dan sebagainya. Kejayaan persidangan ini membawa kepada penganjuran persidangan kedua pada pertengahan 1945 bagi membincangkan kemerdekaan Tanah Melayu tetapi dibatalkan oleh Jepun kerana bimbang perancangan politik sulit para ulamak.

Kekalahan Jepun pada Ogos 1945 telah memberi nafas baru kepada gerakan nasionalisme di Tanah Melayu. Haji Ahmad Fuad mengambil kesempatan ini dengan menubuhkan Persatuan Kebajikan Islam (PERKASA) Terengganu pada 1946. Walaupun pertubuhan ini lebih merupakan sebuah pertubuhan kebajikan, tetapi telah memainkan peranan besar dalam menentang penjajah, khususnya Malaya Union. Ahli-ahli PERKASA telah bergerak ke seluruh Terengganu bagi membangkitkan semangat nasionalisme dan menentang Malayan Union sehingga PERKASA mendapat perhatian British. Penglibatan Haji Ahmad Fuad sebagai Setiausaha Agung PERKASA telah menonjolkan nama beliau sebagai tokoh penting dalam gerakan nasionalisme di Terengganu.

Kemasyhuran nama beliau telah menyebabkan wujud usaha daripada pihak Umno untuk menarik beliau menyertai parti itu setelah Persatuan Melayu Terengganu (PMT) yang bergabung dengan Umno tidak cukup berpengaruh. Pada 1949, Yang Dipertua Agung Umno, Dato' Onn Jaafar sendiri telah datang ke Terengganu bagi memujuk Haji Ahmad Fuad menyertai Umno. Usaha keras Umno untuk menarik sokongan Ahmad Fuad ini adalah untuk menarik golongan agamawan bagi mendukung perjuangan Umno setelah Hizbul Muslimin diharamkan. Atas keyakinan bahawa Umno berjuang untuk kemerdekaan dan mengembangkan

politik Islam, beliau menyertai Umno pada 1949. Semenjak itu, perjuangan kemerdekaan beliau disalurkan melalui Umno apabila dilantik sebagai Pegawai Perhubungan Umno Terengganu selama dua tahun sehingga 1951. Pada 1950 dan 1951, beliau juga diangkat sebagai perwakilan Umno Terengganu ke Mesyuarat Agung Umno.

Penglibatan aktif beliau memperjuangkan kemerdekaan melalui Umno telah menyebabkan beliau dipilih sebagai Ahli Jawatankuasa Kerja Agung Umno pada 1950 hingga 1951 dan dilantik sebagai Pengerusi Jawatankuasa Penasihat Agama dan Adat Istiadat Melayu Umno menggantikan bekas gurunya, Sheikh Abdullah Fahim pada 1950. Beliau juga turut dilantik sebagai Pengerusi Jawatankuasa Kerja Umno Bahagian Kuala Terengganu pada 1951. Pada 25 April 1951, sebagai menghargai sumbangan beliau kepada perjuangan kemerdekaan dan pembangunan umat Islam, beliau telah dilantik sebagai Ahli Majlis Mesyuarat Undangan Persekutuan sebagai Ahli Tidak Rasmi. Beliau merupakan ulamak yang pertama dilantik menduduki majlis perundangan tersebut semenjak ia dibentuk pada 1948.

Krisis kepemimpinan Umno telah tercetus akibat cadangan Dato' Onn Jaafar supaya Umno membuka keahlian kepada orang bukan Melayu. Pada 27 Mei 1950, cadangan Dato' Onn Jaafar telah ditolak oleh perwakilan Umno. Ini menyebabkan Dato' Onn Jaafar mengumumkan untuk tidak bertanding jawatan Yang Dipertua Agung Umno ketika merasmikan Persidangan Alim Ulamak Kedua pada 23 Ogos 1951 di Kuala Lumpur, iaitu beberapa jam sebelum Persatuan Ulamak Malaya ditubuhkan. Pada 28 Ogos 1951, Dato' Onn Jaafar telah menarik diri daripada dicalonkan sebagai Yang Dipertua Agung Umno dan mengumumkan keluar daripada Umno. Haji Ahmad Fuad yang dilantik sebagai Pengerusi Jawatankuasa Penggubal Undang-undang Tubuh Persatuan Ulamak Malaya dicalonkan sebagai Yang Dipertua Agung Umno menentang Tunku Abdul Rahman dan CM Yusof, tetapi beliau telah tewas. Sebagai 'orang kuat' Dato' Onn Jaafar, Haji Ahmad Fuad tidak lagi aktif memperjuangkan kemerdekaan bersama Umno selepas 28 Ogos 1951.

Usaha beliau untuk menuntut kemerdekaan diteruskan melalui PAS yang beliau asaskan pada 1951. Melalui PAS beliau telah berjuang menuntut pilihan raya umum diadakan pada 1954 bagi membolehkan rakyat Tanah Melayu belajar berkerajaan sendiri seterusnya mencapai kemerdekaan. Pada Mei 1953, beliau telah membawa PAS menyertai National Conference anjuran 16 orang kenamaan termasuk tujuh Menteri Besar di bawah pimpinan Datuk Panglima Bukit Gantang. Beliau kemudiannya mengemukakan gagasan Perlembagaan Malaya melalui PAS kepada National Conference sebagai cadangan bentuk perlembagaan Malaya merdeka. Haji Ahmad Fuad juga telah dilantik sebagai Ahli Jawatankuasa National Conference pada 1953.

Pada Ogos 1953, beliau telah mewakili PAS untuk menyertai Persidangan Pertubuhan-pertubuhan Melayu anjuran Umno di Johor Bahru bagi membincangkan tentang cadangan pilihan raya umum. Seminggu kemudian, Haji Ahmad Fuad membawa PAS menghadiri National Convention anjuran Perikatan Umno-MCA yang dipimpin oleh Tunku Abdul Rahman. National Convention telah membentuk sebuah Jawatankuasa Khas tentang pilihan raya, tetapi PAS tidak menyertai jawatankuasa ini. Akibat penglibatan PAS dalam kedua-dua badan gabungan ini telah menimbulkan persoalan di kalangan ahlinya. Akhirnya pada 26 September 1953, satu Mesyuarat Agung Khas PAS diadakan untuk membincangkan pendirian sebenar PAS dalam memperjuangkan kemerdekaan.

Apabila mesyuarat agung itu memutuskan untuk menyokong National Convention, sedangkan Haji Ahmad Fuad cenderung menyokong National Conference, beliau telah

meletakkan jawatan dan menarik diri daripada PAS. Setahun kemudian, apabila Dato' Onn Jaafar menubuhkan Parti Negara (PN) bagi menggantikan Independent Malayan Party (IMP), Haji Ahmad Fuad telah menyertai PN pada 28 Februari 1954. Penglibatan beliau dalam PN kerana memperjuangkan kemerdekaan bersama Dato' Onn Jaafar telah menyebabkan beliau dilantik sebagai Ahli Jawatankuasa Eksekutif PN selama dua tahun sehingga 1956. Kerana hasratnya yang mahukan Malaya merdeka sebagai sebuah Negara Islam, pada 1956, beliau bersama beberapa tokoh lain telah mengasaskan penubuhan parti Islam, Nahdatul Ulama untuk memperjuangkan penubuhan Negara Islam yang sederhana dan dipilih sebagai Naib Yang Dipertua Nahdatul Ulama.

Walau bagaimanapun, penglibatan beliau dalam Nahdatul Ulama tidak begitu menonjol lebih-lebih lagi parti tersebut tidak mendapat sokongan rakyat kerana Yang Dipertuanya, Ustaz Abu Bakar Hamzah sendiri aktif dalam PAS semenjak 1956. Apabila Tanah Melayu mencapai kemerdekaan pada 31 Ogos 1957, kegiatan politik Haji Ahmad Fuad untuk memperjuangkan kemerdekaan juga turut terhenti. Beliau kemudiannya lebih banyak memberikan tumpuan untuk membangunkan masyarakat menerusi institusi pendidikan yang dipimpinya iaitu Madrasah al-Masriyah dan juga menjalankan urusan perniagaan, terutama sebagai Pengarah *Utusan Melayu* sehingga 1966.

MEMPELOPORI PEMBAHARUAN PENTADBIRAN DAN POLITIK ISLAM

Pengalaman luas Haji Ahmad Fuad sebagai pentadbir agama di Terengganu selama hampir 10 tahun dan sebagai Ahli Majlis Mesyuarat Undangan Persekutuan selama lima tahun telah membantu beliau merangka gagasan-gagasan ke arah pembaharuan pentadbiran dan politik Islam. Walaupun beliau tidak terlibat dengan gerakan politik Islam seperti MATA dan Hizbul Muslimin yang begitu aktif memperjuangkan idea-idea politik Islam, tetapi penglibatan beliau dalam PERKASA telah menjadi saluran untuk beliau mengembangkan idea ini. Namun begitu, beberapa gagasan MATA untuk membuat penyelarasan pentadbiran agama Islam telah mendapat perhatian beliau.

Pendedahan pertama tentang kelemahan pentadbiran agama Islam kepada beliau bermula apabila beliau menyertai Persidangan Majlis Agama Malai-Sumatera di Kuala Kangsar pada 1944. Isu-isu yang dibincangkan seperti penyelarasan tarikh permulaan puasa, tarikh hari raya dan fatwa cukup untuk mendedahkan kepada beliau tentang masalah sebenar yang timbul di kalangan umat Islam di Tanah Melayu. Apabila beliau aktif dalam Umno, beliau telah menggunakan saluran Umno seperti *Suara Umno* untuk mengagaskan idea pembaharuan pentadbiran Islam ini. Beberapa rencana tulisan beliau dalam *Suara Umno* seperti '*Menyatukan Pentadbiran Agama Islam*' dengan jelas membincangkan isu penyusunan semula institusi zakat, wakaf dan pelajaran agama; penyeragaman puasa dan hari raya; memperluaskan penerangan dan dakwah Islam; serta menubuhkan Lembaga Mesyuarat Agama Malaya yang melibatkan semua mufti dan qadhi besar yang setaraf dengan Majlis Mesyuarat Undangan Persekutuan.

Penglibatan beliau dalam Jawatankuasa Penasihat Agama dan Adat Istiadat Melayu Umno telah dimanfaatkan sepenuhnya bagi mencapai matlamat tersebut. Bagi menjayakan gagasannya, beliau melalui jawatankuasa tersebut telah menganjurkan satu Persidangan Alim Ulama Malaya di Muar pada Februari 1950. Persidangan ini membincangkan masalah pentadbiran agama Islam di Tanah Melayu dan usaha penyelarannya. Persidangan tersebut kemudiannya meluluskan usul penubuhan Majlis Agama Malaya untuk menyelaraskan masalah pentadbiran agama, selain mengemukakan cadangan untuk membentuk sebuah badan

dakwah Islam, *Jam'iyatul Da'watul Islamiyah* bagi menyelaraskan kegiatan dakwah Islam di kalangan alim ulamak.

Selepas persidangan ulamak ini, tercetus isu Natrah di Singapura yang cuba dimurtadkan melalui mahkamah. Umno telah berlepas tangan dalam isu memurtadkan Natrah ini sehinggalah mahkamah membuat keputusan pada Disember 1950. Kenyataan Dato' Onn Jaafar bahawa masalah undang-undang di Singapura tidak ada kaitan dengan Umno dan isu yang diperjuangkan oleh Dr Burhanuddin al-Helmy ini disokong oleh komunis, telah memberikan kesedaran kepada Haji Ahmad Fuad tentang sikap sebenar Umno terhadap Islam. Tambahan pula ketika itu Umno langsung tidak mempedulikan pandangan ulamak termasuk Jawatankuasa Penasihat Agama dan Adat Istiadat Melayu Umno dalam menjalankan beberapa aktiviti yang disifatkan sebagai haram seperti judi letori, kabaret, fun fair dan seumpamanya bagi mengisi dana dan kewangan Umno. Semua ini berpunca daripada ketiadaan satu undang-undang khusus tentang hukum syarak untuk mengawal aktiviti umat Islam di Malaya.

Kekesalan Haji Ahmad Fuad terhadap sikap pemimpin Umno yang mengabaikan gagasan Persidangan Alim Ulamak tidak dapat disembunyikan lagi. Oleh itu, pada 25 Mac 1951, dalam Persidangan Setengah Tahun Umno di Kuala Lumpur, beliau atas nama Pengerusi Jawatankuasa Penasihat Agama dan Adat Istiadat Melayu Umno telah mengemukakan satu usul kepada Umno yang berbunyi, "Bahawa Majlis Mesyuarat Agung ini bersetuju supaya Jawatankuasa Kerja Agung Umno menjalankan ikhtiar pada menghasilkan supaya undang-undang yang berkenaan hukum syarak dan perkara agama yang berkenaan dengan orang-orang Islam di seluruh Persekutuan Tanah Melayu termasuk Singapura dikemaskan dan disatukan". Usul ini kemudiannya mendapat sokongan padu daripada para perwakilan. Kerana pandangan-pandangan beliau tentang pentadbiran agama ini, beliau kemudiannya dilantik menganggotai Majlis Penasihat Islam Pulau Pinang dan Seberang Perai.

Walaupun usul ini telah diterima oleh Umno, tetapi ternyata kepemimpinan Umno tidak begitu serius dalam menangani masalah pentadbiran agama Islam. Pada 1 Jun 1951, *Suara Umno* telah menyiarkan kritikan Haji Ahmad Fuad terhadap pemimpin Umno yang membiarkan ulamak dan umat Islam terus terpinggir. Tulisan beliau yang bertajuk '*Ulamak Malaya Belum Bersatu dan Belum Mempunyai Persatuan*' telah menyeru para ulamak bersatu untuk mengembalikan kekuatan umat Islam di bawah satu payung. Melalui penyatuan ini, para ulamak dapat memulihkan pentadbiran agama Islam di Malaya. Sebagai respon kepada tulisan Haji Ahmad Fuad, pada 30 Jun 1951, Umno telah bersetuju untuk menganjurkan Persidangan Alim Ulamak Kedua dalam bulan Ogos 1951.

Persidangan Alim Ulamak Kedua di Kuala Lumpur pada 23 Ogos 1951 ini juga dianjurkan oleh jawatankuasa yang dipengerusikan Haji Ahmad Fuad. Tujuan utamanya ialah untuk membincangkan isu-isu umat semasa umat Islam, tetapi Haji Ahmad Fuad telah mengemukakan usul untuk menubuhkan Persatuan Ulamak Malaya, iaitu satu sayap ulamak yang boleh mengimbangi sikap Umno yang tidak melindungi kepentingan Islam. Umno sendiri berharap agar para ulamak mendukung perjuangan mereka. Umno sangat bimbang sekiranya perjuangan mereka ditolak oleh para ulamak yang berada dalam majlis-majlis agama negeri yang dikuasai oleh British. Sebagai persiapan untuk menjawab sebarang fatwa mufti-mufti negeri, Umno perlu menubuhkan satu sayap ulamak bagi memberikan fatwa balas tentang kemerdekaan ini, dan kerana itulah Umno menyokong penubuhan persatuan ulamak yang dicadangkan oleh Haji Ahmad Fuad ini.

Persidangan ulamakk ini juga telah meluluskan cadangan Haji Ahmad Fuad untuk menubuhkan Majlis Tertinggi Khas untuk mentadbir urusan agama. Lima orang wakil ulamak telah dipilih iaitu Haji Ahmad Fuad, Haji Abdul Hamid Fadhil, Haji Ghazali Abdullah, Haji Mohd Fadhullah Suhaimi dan Haji Ahmad Badawi untuk mengutuskan cadangan kepada Raja-raja Melayu bagi menubuhkan satu pusat pentadbiran agama Islam yang dinamakan Majlis Tertinggi Khas tersebut. Majlis tersebut diketuai oleh seorang pengerusi dan dibantu oleh seorang setiausaha dengan dianggotai oleh para mufti dan juga qadhi besar setiap negeri. Idea yang dicanangkan oleh Haji Ahmad Fuad inilah yang diterjemahkan sebagai Majlis Fatwa Kebangsaan pada hari ini.

Akhirnya persatuan ulamak yang cuba dijadikan sebagai sayap agama Umno, telah dibawa oleh Haji Ahmad Fuad sebagai sebuah pertubuhan politik Islam yang berasingan daripada Umno kerana para ulamakk yang menyertai persidangan itu mahu ulamak berpisah dengan Umno kerana menyedari sikap Umno yang tidak mengambil berat tentang Islam. Persatuan ini kemudiannya dikenali sebagai Persatuan Islam Se-Malaya (PAS). Melalui PAS, Haji Ahmad Fuad memperjuangkan semula soal penyelarasan pentadbiran agama, penubuhan kolej Islam, pendaulatan undang-undang Islam, pengukuhan kedudukan orang-orang Melayu dan sebagainya. Gagasan pemikiran Haji Ahmad Fuad dapat dilihat dengan jelas melalui Perlembagaan Malaya yang digubal oleh PAS pada 1953 yang menekankan soal kedudukan agama Islam sebagai agama rasmi, penyelarasan pentadbiran Islam dan penubuhan Kementerian Agama untuk mentadbir urusan agama Islam; penubuhan negara demokrasi berparlimen dengan sistem kabinet dan kementerian; kedudukan bahasa Melayu sebagai bahasa rasmi dan kerakyatan yang tidak berasaskan *Jus Soli*.

MENDUKUNG PEMIKIRAN KAUM TUA

Walaupun Haji Ahmad Fuad telah terlibat dan terdedah dengan gerakan Kaum Muda dengan begitu meluas di Kuala Kangsar, Gunung Semanggol dan Mekah, tetapi pengaruh guru utamanya Sheikh Hassan Yamani mengungguli pemikiran fiqhnya. Gurunya terkenal sebagai seorang pendukung kuat Ahli Sunnah Wal Jamaah. Bahkan, tindakan Sheikh Hassan Yamani meninggalkan Mekah semenjak 1930-an untuk berkhidmat sebagai guru di Perak dan mufti di Terengganu mempunyai kaitan yang besar dengan sikapnya yang menolak pemikiran pembaharuan yang dibawa oleh Sheikh Mohamad Abdul Wahab dalam mengasaskan Kerajaan Saudi di Hijaz. Kerana menolak pemikiran Wahabbi ini, beliau berhijrah ke Malaya.

Oleh kerana Haji Ahmad Fuad hidup bersama ‘bapa angkat’nya itu semenjak di Madrasah Idrisiah, Kuala Kangsar pada 1931 sehingga beliau berhijrah ke Madrasah al-Masriyah, Bukit Mertajam 20 tahun kemudian, tempoh tersebut telah mempengaruhi pendirian fiqh Ahli Sunnahnya yang tebal. Walaupun beliau terkenal dengan beberapa gagasan pembaharuan dalam pentadbiran dan politik Islam, termasuk memperkenalkan sistem pendidikan moden di Terengganu dan Bukit Mertajam, beliau terus dicop sebagai ‘pendukung Kaum Tua’ dalam aliran fiqh. Beliau sering berhujah bagi pihak ulamak-ulamak Kaum Tua setiap kali tercetus polemik fiqh yang bersifat furi’iyah. Tetapi pandangan beliau tentang perkara-perkara asas Islam seperti kewajipan berjuangan menegakkan agama Allah, kewajipan menegakkan Negara Islam, kewajipan memperjuangkan kemerdekaan, kewajipan menegakkan hukum syariat dan seumpamanya adalah sangat jelas.

Satu perkara yang sangat jelas dalam ‘pemikiran Kaum Tua’ Haji Ahmad Fuad ialah menolak perbuatan-perbuatan yang bercanggah dengan hukum Islam. Ketika beliau membawa Persatuan Ulamakk Malaya yang diasaskannya menjadi PAS dan menentang Umno, sebab

utamanya ialah kerana beliau menolak pemikiran sekular yang wujud dalam kepemimpinan Umno. Beliau secara terang-terangan membantah tindakan Umno mengadakan perjudian letori, menganjurkan fun fair dan menganjurkan tarian kabaret untuk mengisi dana kewangan Umno. Lebih terkesan lagi apabila Umno berlepas tangan dalam isu Natrah pada 1950, Umno telah membiarkan perempuan tersebut dimurtadkan semata-mata untuk menjaga hubungan dengan penjajah British. Walaupun mendukung pemikiran Kaum Tua, penentangannya terhadap pemikiran sekular amat keras.

Kerana mendukung aliran Kaum Tua, Haji Ahmad Fuad beberapa kali bergeseran dengan ulamak-ulamak reformis sekitar 1950-an. Polemik pertama tercetus pada 1952 apabila seorang ulamak Kaum Muda yang juga Ketua PAS Cawangan Pulau Pinang, Ustaz Ibrahim Aqibi melalui satu artikel dalam *Utusan Melayu* mendakwa kaedah hisab patut digunakan untuk memulakan puasa Ramadhan, bukan semata-mata rukyah sahaja. Haji Ahmad Fuad sebaliknya mendakwa kaedah hisab tidak boleh digunakan, kerana keempat-empat mazhab Ahli Sunnah tidak menerima hisab sebagai penyelesaian masalah itu. Keadaan menjadi bertambah rumit apabila Haji Ahmad Fuad mengatakan harus menerima 'pemberian' parti MCA sebanyak RM500,000.00 walaupun ia berpunca daripada perjudian letori.

Hujah Haji Ahmad Fuad ialah berasaskan pendapat Mazhab Maliki yang menganggap wang yang haram apabila berpindah milik kepada pihak ketiga ia menjadi halal. Timbalan Yang Dipertua Agung PAS, Haji Ghazali Abdullah (kemudian Mufti Perak dan Selangor) yang beraliran Kaum Muda menolak pandangan ini kerana asas judi adalah haram. Selain itu, beberapa isu lain turut dibangkitkan oleh ulamak Kaum Muda, khususnya Ustaz Ibrahim Aqibi sehingga wujud perselisihan pendapat di antara beliau dengan Mufti Pulau Pinang, Sheikh Abdullah Fahim, yang juga Ketua Dewan Ulamak PAS. Satu perdebatan antara Mufti dengan Ustaz Ibrahim Aqibi diatitkan oleh penyokong Kaum Muda, tetapi ditolak oleh Majlis Penasihat Islam Pulau Pinang yang turut dianggotai oleh Haji Ahmad Fuad.

Keadaan ini memaksa Haji Ahmad Fuad membawa perkara tersebut ke Kepala Batas dengan menganjurkan satu Muzakarah Ulamakk di Madrasah ad-Daeratul Maarif, Kepala Batas pada 4 Januari 1953 sehari selepas Mesyuarat Agung PAS Pertama. 21 orang ulamak termasuk ulamak Kaum Muda seperti Ustaz Ibrahim Aqibi, Sheikh Tahir Jalaluddin, Haji Ghazali Abdullah dan lain-lain dijemput. 16 isu (*masa'il khilafiah*) akan dibincangkan termasuk isu ketidakhurusan wanita terlibat dalam politik. Walau bagaimanapun, ulamakk Kaum Muda memulaukan muzakarah ini kerana Haji Ahmad Fuad bertegas mahu mempertahankan pandangannya. Muzakarah ini dianggap 'dimenangi' oleh Kaum Tua yang diketuai Haji Ahmad Fuad, dan Haji Ahmad Fuad menyusun sebuah buku, '*Risalah Ketetapan Majlis Muzakarah Se-Melaya*'⁶³ untuk menghuraikan pandangan ulamakk Kaum Tua.

Kaum Muda tidak berhenti dengan 'kekalahan' ini, tetapi telah menerbitkan pula '*Risalah Penebas Bid'ah di Kepala Batas*'⁶⁴, sebuah buku tulisan Sheikh Tahir Jalaluddin untuk menjawab hujah Kaum Tua. Kaum Muda juga telah menganjurkan satu Muzakarah Kedua. Sebagai Yang Dipertua Agung PAS, Haji Ahmad Fuad memberikan tiga syarat untuk menyertai muzakarah ini iaitu mestilah menjemput semua mufti, Pengerusi Majmak Sheikhul Islam Kedah, Ketua Jabatan Agama Perlis dan Qadi Besar Singapura serta dibuka kepada alim ulamak sahaja. Muzakarah ini kemudiannya dipulaukan oleh ulamak Kaum Tua. Keadaan ini berterusan pada 1956 apabila Ketua Dewan Ulamak PAS Perlis yang mendukung Kaum Muda,

⁶³ Ahmad Fuad Hassan (1953), *Risalah Ketetapan Majlis Muzakarah Se-Malaya*, Persama Press, Pulau Pinang. Lihat juga *Risalah Ketetapan Majlis Muzakarah 15 Masalah* (1953), Jaafar Siddiq Rawa, Pulau Pinang.

⁶⁴ Sheikh Tahir Jalaluddin (1953), *Risalah Penebas Bid'ah di Kepala Batas*, Persama Press, Pulau Pinang.

Sheikh Abu Bakar al-Asy'ari menulis buku '*Sembahyang Rasulullah*' dan '*Kemerdekaan Berfikir*' yang turut tidak dipersetujui oleh Haji Ahmad Fuad.

Walau bagaimanapun, ketika menjelang Pilihan raya Umum 1955 satu fatwa telah dikeluarkan bersama oleh Mufti Pulau Pinang, Sheikh Abdullah Fahim; Tuan Guru Haji Salleh al-Masri (Ahli Majlis Penasihat Agama Pulau Pinang) dan Ustaz Abdul Halim al-Hadi (Mudir Madrasah ad-Daeratul Maarif) mengenai kewajipan umat Islam turun mengundi dan wajib mengundi calon Islam sahaja. Fatwa ini menimbulkan kemarahan pemimpin Perikatan yang turut mencalonkan orang-orang bukan Islam. Para pemimpin PAS seperti Cikgu Ahmad Awang menyokong fatwa ini. Haji Ahmad Fuad pula sependapat dengan mertuanya, Tuan Guru Haji Salleh al-Masri bahawa fatwa tersebut berasaskan nas-nas yang jelas dan tidak memerlukan sebarang takwil lagi. Sebenarnya, pada 1953, PAS ketika dipimpin oleh Haji Ahmad Fuad telah menyertai Muktamar Ulamakk Nusantara di Kuala Lumpur dan bersetuju memutuskan bahawa wajib bagi umat Islam Indonesia menyertai pilihan raya negara tersebut untuk membolehkan syariat Islam ditegak dan dilaksanakan.

MENGASASKAN GERAKAN ISLAM

Penglibatan luas Haji Ahmad Fuad dengan gerakan Islam semenjak di Maahad Il Ihya telah memungkinkan beliau muncul sebagai seorang tokoh gerakan Islam yang penting dalam sejarah negara ini. Penglibatan pertama beliau dengan gerakan Islam bermula apabila beliau menjadi ahli Kelab Saadat Kuala Kangsar, iaitu satu kelab Kaum Muda yang menjadi medan perbincangan isu-isu semasa umat Islam. Tetapi beliau tidak aktif dengan kelab ini, sebaliknya cergas sebagai Setiausaha PASPAM Cawangan Gunung Semanggol. PASPAM merupakan satu persatuan pembaca-pembaca akhbar *Saudara*, sebuah akhbar pimpinan tokoh reformis, Syed Sheikh al-Hadi yang berpusat di Pulau Pinang. PASPAM bergerak aktif dalam isu-isu umat Islam serta sastera dan bahasa Melayu. Kemunculan PASPAM penting kerana ia adalah persatuan separa politik umat Islam yang pertama bertaraf nasional dan mempunyai cawangan di seluruh negara termasuk Sabah, Sarawak dan Labuan.

Penglibatan singkat Haji Ahmad Fuad dengan gerakan Islam di Mekah dan pertemuan beliau dengan Dr Burhanuddin al-Helmy di Kuala Kangsar pada 1944 juga turut membentuk pemikiran beliau terhadap perjuangan gerakan Islam. Penglibatan yang lebih menonjol muncul apabila beliau mengasaskan PERKASA di Terengganu pada 1946 sebagai sebuah pertubuhan kebajikan separa politik Islam. PERKASA bergiat cergas dalam bidang pendidikan, kebajikan dan juga perjuangan menentang Malayan Union. Walaupun PERKASA tidak begitu menonjol kecuali di Terengganu, tetapi di sinilah Ahmad Fuad sebagai Setiausaha Agung, mengasah bakat politik Islamnya. Dato' Onn Jaafar berusaha menarik Haji Ahmad Fuad menyertai Umno kerana pengaruh PERKASA yang kukuh di Terengganu.

Jika tidak kerana penglibatan aktifnya dalam PERKASA di Terengganu, besar kemungkinan Haji Ahmad Fuad akan terlibat secara aktif dalam MATA dan Hizbul Muslimin. Ini kerana kedua-dua pertubuhan ini diasaskan oleh gurunya, Ustaz Abu Bakar al-Baqir bersama Dr Burhanuddin al-Helmy. Bahkan seorang lagi guru utamanya, Sheikh Abdullah Fahim turut menjadi Ahli Majlis Penasihat MATA. Tetapi kerana tumpuan beliau terhadap perjuangan PERKASA untuk membela kebajikan Islam, beliau telah hanya aktif bersama PERKASA. Kemudian, melalui PERKASA beliau menyertai Umno. Bersama Umno pula, beliau telah dilantik untuk mengetuai Jawatankuasa Penasihat Agama dan Adat Istiadat Umno atau dikenali juga sebagai Bahagian Agama Umno, satu biro yang pernah diketuai oleh Sheikh Abdullah Fahim. Kemungkinan beliau terlibat dengan MATA dan Hizbul Muslimin adalah

amat jelas kerana ketika beliau menganjurkan beberapa persidangan ulamak di bawah tajaan Umno, Persatuan Il Ihya dan Maahad Il Ihya turut dijemput menyertainya.

Tetapi setelah menyedari sikap hipokrit Umno terhadap Islam, Haji Ahmad Fuad mendukung Persidangan Alim Ulamak Malaya pertama anjuran Bahagian Agama dan Pelajaran Umno di Muar pada 21-22 Februari 1950. Dalam persidangan ini, satu cadangan menubuhkan sebuah badan ulamakk untuk bergerak dalam bidang politik dan dakwah dicadangkan dengan nama *Jam'iyatul Da'watul Islamiyah*. Cadangan ini telah diterima untuk dibincangkan pada masa akan datang. Setahun kemudian, Haji Ahmad Fuad sendiri yang membangkitkan masalah ulamak yang tidak mempunyai persatuan sehingga menyukarkan mereka bergerak menangani isu-isu umat Islam. Gesaan Haji Ahmad Fuad pada 1 Jun 1951 ini telah membawa kepada Persidangan Alim Ulamak Malaya kedua pada 23 Ogos 1951 yang bertujuan untuk membincangkan penubuhan Persatuan Ulamak Malaya. Persidangan tersebut juga menerima usul daripada Yang Dipertua Jabatan Agama Johor, Engku Ismail Abdul Rahman supaya sebuah parti politik Islam, Parti Muslimin Malaya ditubuhkan.

Setelah cadangan ini diterima oleh ahli-ahli persidangan, Haji Ahmad Fuad dilantik sebagai Pengerusi Jawatankuasa Penaja sebagai penggubal Undang-undang Tubuh Persatuan Ulamakk Malaya. Persidangan itu juga bersetuju supaya undang-undang tubuh tersebut disahkan dalam satu persidangan ulamak di Seberang Perai pada akhir 1951. Haji Ahmad Fuad telah memainkan peranan besar bersama Haji Ayub, S Mohamed Shafie, Saadon Jubir dan Haji Asya' untuk menggubal undang-undang tubuh persatuan ulamak tersebut. Adalah jelas pengaruh Haji Ahmad Fuad terhadap undang-undang tubuh persatuan ini kerana ia mempunyai persamaan dengan Undang-undang Tubuh PERKASA yang diasaskan oleh Haji Ahmad Fuad pada 1946. Setelah ia siap digubal, undang-undang ini dibawa ke Persidangan Persatuan Ulamak Malaya di Bagan Tuan Kechil (Butterworth) pada 24 November 1951.

Persidangan pada 24 November 1951 ini sangat penting bagi Haji Ahmad Fuad kerana menandakan bermulanya kelahiran sebuah gerakan Islam terbesar di Malaysia hasil usaha beliau. Setelah undang-undang tubuh tersebut dikemukakan, satu cadangan untuk menukar namanya kepada Persatuan Islam Se-Malaya (PAS) dibuat oleh Ustaz Othman Hamzah, wakil Persatuan Il Ihya, selain enam nama lain turut dicadangkan. Setelah persatuan ulamak tersebut bernama PAS, Haji Ahmad Fuad yang tidak hadir kerana keuzuran dicalonkan sebagai Yang Dipertua PAS menentang gurunya, Sheikh Abdullah Fahim. Turut dicalonkan sebagai Ahli Jawatankuasa Agung PAS ialah seorang lagi gurunya, Ustaz Abu Bakar al-Baqir, bekas Ketua Umum Hizbul Muslimin dan MATA yang ketika itu sedang ditahan di bawah Ordinan Darurat semenjak 1948.

Haji Ahmad Fuad dipilih sebagai Yang Dipertua PAS pertama. Di bawah pimpinannya, PAS telah bergiat cergas dalam menggerakkan pembangunan pendidikan Islam, menyelaraskan pentadbiran agama, perjuangan kemerdekaan menerusi National Conference dan mengemukakan cadangan Perlembagaan Malaya. PAS juga telah berkembang dengan pesat bermula dengan penubuhan cawangan pertama di Pulau Pinang pada 9 Mac 1952 kepada cawangan ke-14 pada 21 September 1953, iaitu seminggu sebelum beliau meletakkan jawatan. Di bawah pimpinan beliau juga, PAS berjaya menubuhkan Dewan Ulamak, Dewan Pemuda dan Dewan Muslimat sebagai sayap parti. Kepemimpinan beliau hampir dua tahun berjaya membina asas yang kukuh bagi PAS walaupun secara umumnya PAS masih lemah.

Setelah keluar daripada PAS pada 26 September 1953 kerana menolak keputusan Mesyuarat Agung Khas PAS untuk menyertai National Convention tajaan Perikatan Umno-

MCA, beliau telah menyertai PN kerana Dato' Onn Jaafar memberitahu bahawa parti tersebut juga berjuang untuk menegakkan Islam. Beliau tidak menyertai pilihan raya 1955 walaupun PN bertanding di beberapa kerusi Majlis Mesyuarat Undangan Persekutuan. Dengan itu beliau menamatkan khidmatnya sebagai Ahli Tidak Rasmi majlis tersebut yang disandangnya semenjak 1951. Beliau tidak dapat memberikan sumbangan besar kepada PN kerana parti ini dipimpin oleh tokoh-tokoh politik yang terkenal termasuk Dato' Onn Jaafar, Datuk Panglima Bukit Gantang, Datuk Nik Ahmad Kamil dan lain-lain.

Tetapi tempoh dua tahun bersama PN menyedarkan beliau hakikat sebenar perjuangan PN. Atas sebab itu, beliau menyertai majlis penubuhan sebuah parti Islam baru yang dianjurkan oleh Ustaz Wan Hassan Wan Ahmad di Sungai Sumun, Perak iaitu parti Nahdatul Ulama. Parti ini bertujuan untuk berjuang menegakkan negara Islam dengan pendekatan sederhana dan tidak radikal. Haji Ahmad Fuad yang dicalonkan sebagai Yang Dipertua Nahdatul Ulama tewas kepada Ustaz Abu Bakar Hamzah, dan dipilih sebagai Naib Yang Dipertua. Walau bagaimanapun, parti Nahdatul Ulama tidak bertahan lama kerana ketiadaan sokongan rakyat, lebih-lebih lagi Yang Dipertuanya, Ustaz Abu Bakar Hamzah dan penganjurnya, Ustaz Wan Hassan Ahmad telah menyertai secara aktif dalam PAS.

Selepas terkuburnya Nahdatul Ulama, Haji Ahmad Fuad tidak lagi aktif dalam mana-mana parti politik dan gerakan Islam. Sebaliknya beliau memberikan tumpuan kepada tugasnya sebagai mudir Madrasah al-Masriyah dan Pengarah Utusan Melayu. Haji Ahmad Fuad juga turut menghabiskan masanya untuk menghasilkan terjemahan *Sahih Bukhari* dan menulis kitab *Bidayatul Hidayah* yang tidak sempat diterbitkan. Penyertaan Haji Ahmad Fuad sebagai Setiausaha PASPAM Gunung Semanggol, Setiausaha Agung PERKASA, Pengerusi Bahagian Agama Umno, Yang Dipertua Agung PAS dan Naib Yang Dipertua Nahdatul Ulama adalah sebahagian daripada kegiatan beliau dalam gerakan Islam. Tetapi tindakan beliau mengasaskan PAS adalah sumbangan terbesar kepada umat Islam di negara ini.

MENJADI SENATOR PADA HARI KEMATIAN

Selepas hampir 10 tahun 'bersara' daripada politik kepartian, Haji Ahmad Fuad yang cergas dalam dunia persuratkhabaran, pendidikan, perniagaan dan penulisan kitab-kitab agama telah dikesan mengidap sakit jantung. Pada 21 Oktober 1966, beliau ketika menghadiri satu seminar di Kuala Lumpur, beliau telah diserang sejenis penyakit iaitu 'coronary thrombosis' sehingga jatuh pingsan. Beliau segera di bawa ke Hospital Besar Kuala Lumpur dalam keadaan nazak. Pada keesokannya, 22 Oktober 1966, beliau telah dipanggil menemui Ilahi setelah lebih 30 tahun berjuang menegakkan Islam di negara ini. Beliau pergi sebelum sempat isteri dan anak-anaknya tiba dari Pulau Pinang. Menurut Subky Abdul Latif yang mendapat informasi dari anak sulungnya, Suraya, bahawa kerajaan telah memutuskan untuk melantik Haji Ahmad Fuad sebagai Ahli Dewan Negara. Pada hari kematiannya itu, keluarga beliau menerima surat dari kerajaan tentang perlantikan tersebut.

Beliau meninggalkan seorang balu, Hajjah Saudah binti Salleh, iaitu anak bongsu kepada Tuan Guru Haji Salleh al-Masri, pengasas Madrasah al-Masriyah. Beliau juga meninggalkan enam orang anak iaitu Suraya, Ahmad Taufik, Kausar, Ahmad Shaqib, Dina dan Muna. Jenazah beliau dibawa pulang ke Bukit Mertajam dan disemadikan di perkuburan Masjid Bukit Berapit, Bukit Mertajam mengikut wasiatnya.

RUJUKAN

- Ahmad Subky Latif, temuramah pada 18 April 2002. Beliau adalah wartawan di Warta Negara dan Utusan Melayu, 1964-1974.
- Ismail Said (2011), *Menegak Agama Membela Bangsa: Perjuangan PAS 1951-1970*, Unit Buku Harakah, Kuala Lumpur
- Mohd Fadli Ghani (2016), *Membina Jiwa Merdeka: Sejarah PAS 1951-1957*, Penerbitan Harakah, Kuala Lumpur
- Ruziah Sulong (1986), *Tuan Haji Ahmad Fuad Hassan: Biografi Politik*, latihan ilmiah Jabatan Sejarah UKM.
- Subky Abdul Latif (2013), *Propagandis Zaman*, Kemilau Publika, Sungai Buloh.
- Tajuddin Saman (1996), Haji Ahmad Fuad: Ulama Tegas dan Berani, dlm. *Tokoh Ulama Nusantara*, Berita Publishing, Kuala Lumpur.
- Tajuddin Saman (1996), Haji Ahmad Fuad: Ulama dan Berani, dlm. *Ruangan Bicara Islam, Berita Minggu*.
- Tajuddin Saman dan Abdul Manaf Ahmad (2005), *Tokoh-tokoh Agama dan Kemerdekaan Alam Melayu*, YADIM, Kuala Lumpur.

Pengurusan Masyarakat Kepelbagaian dalam Kawasan Rukun Tetangga di Malaysia: Satu Analisis

Zaleha Embong
Fakulti Pengajian Bahasa dan Pembangunan Insan,
Universiti Malaysia Kelantan
zaleha.e@umk.edu.my

ABSTRAK

Kawasan Rukun Tetangga (KRT) adalah sebuah organisasi yang menekankan konsep sukarela dan merupakan satu-satunya organisasi sukarela yang ditubuhkan di bawah Akta Parlimen. KRT bertujuan mempromosikan kefahaman dan interaksi dalam masyarakat kepelbagaian di negara ini. Hal ini bertepatan dengan objektif penubuhan KRT iaitu memelihara, meningkatkan dan mengukuhkan perpaduan serta integrasi nasional selaras dengan dasar-dasar kerajaan berlandaskan Perlembagaan Persekutuan dan Rukun Negara. Pelbagai program yang diadakan di KRT bertujuan untuk mengurus masyarakat kepelbagaian demi memupuk hubungan kesepaduan sosial. Proses dan usaha yang dimainkan oleh KRT dalam hal kemasyarakatan telah memberi implikasi besar kepada hubungan masyarakat Malaysia. Maka, menjadi objektif kajian ini untuk mengenal pasti kaedah pengurusan masyarakat kepelbagaian di KRT dan menganalisis peranannya dalam memperkukuh kesepaduan sosial. Artikel ini menggunakan kaedah kualitatif iaitu kaedah kepustakaan dan temu bual secara mendalam. Manakala, kaedah penganalisisan data pula menggunakan kaedah analisis kandungan. Hasil dapatan mendapati, KRT wujud sebagai ruang pertemuan untuk melaksanakan pelbagai program dan menyelesaikan masalah sosial. Program-program yang dilaksanakan secara sistematik dan terancang membantu menguruskan masyarakat kepelbagaian dalam KRT. Hal ini memberi manfaat kepada masyarakat dan negara dalam usaha memperkukuh kesepaduan sosial yang dikecapi negara pada ketika ini.

Kata kunci: Pengurusan; Masyarakat Kepelbagaian; Kawasan Rukun Tetangga; Kesepaduan Sosial

PENGENALAN

Kewujudan masyarakat kepelbagaian boleh membawa kepada konflik dan peperangan. Malahan boleh menjejaskan kestabilan sosiopolitik, ekonomi, pembangunan, infrastruktur, pendidikan dan sebagainya. Dari sudut yang lain pula, kewujudan masyarakat majmuk dapat membina hubungan kerjasama dan mencapai keharmonian. Jelas bahawa kepelbagaian dan perbezaan latar belakang bukan satu halangan malah bertindak sebagai aset berharga kepada sesebuah negara.

Di Malaysia, pemupukan hubungan kerjasama dan permuafakatan telah bermula sejak tahun 1949 lagi. Hal ini melibatkan kerjasama politik antara masyarakat Melayu dan bukan Melayu. Usaha ini telah dilakukan oleh Onn Jaafar dan Gabenor Jeneral British di Asia Tenggara iaitu Malcolm MacDonald dengan menubuhkan Communities Liaison Committee (CLC) atau Jawatankuasa Perhubungan Kaum. CLC sebuah badan berbilang etnik disertai oleh masyarakat Melayu yang diketuai oleh Onn Jaafar sebagai wakil UMNO manakala masyarakat Cina diketuai oleh Tan Cheng Lock sebagai wakil MCA. Penubuhan ini bertujuan mewujudkan kesefahaman dan hubungan kerjasama dalam kalangan masyarakat majmuk (Zaid Ahmad et al., 2010; Chamil Wariya, 1987; Ishak Saat, 2010; Shamsul Amri Baharuddin, 2012). Hal ini telah membolehkan Persekutuan Tanah Melayu mencapai kemerdekaan pada 31 Ogos 1957 (Fadilah Zaini & Kassim Thukiman, 2009).

Selain itu, pihak kerajaan telah melakukan pelbagai inisiatif melalui transformasi pembangunan ekonomi dan politik dalam membina masyarakat majmuk yang bersatu padu. Misalnya, pelaksanaan Dasar Ekonomi Baru (DEB) pada tahun 1970 melalui Rancangan Malaysia Kedua (1971-1975). Dasar ini diperkenalkan selepas peristiwa rusuhan kaum pada 13 Mei 1969 yang bertujuan membetulkan ketidakseimbangan sosioekonomi antara pelbagai kaum. Matlamat utama DEB ialah bagi mewujudkan perpaduan negara dan integrasi nasional dengan mengurangkan perbezaan ekonomi, sosial, kebudayaan, penempatan dan sebagainya (Chamhuri Siwar, 1991). Pada tahun 1991 pula, Wawasan 2020 diperkenalkan bertujuan mencapai negara maju merangkumi aspek ekonomi, politik, sosial, kerohanian dan kebudayaan. Selepas itu, pendekatan Islam Hadhari diperkenalkan pada tahun 2006 sebagai usaha mencapai integrasi kaum, mengukuhkan kestabilan dan kemakmuran dalam kalangan masyarakat majmuk. Prinsip Islam Hadhari yang bersifat universal dapat memberi ruang kepada masyarakat majmuk untuk berbaik-baik, bertoleransi dan saling menghormati demi mencapai keamanan (Mohd Azizuddin Mohd Sani, 2010; Khairul 'Azmi Mohamad & Nooraini Othman, 2009). Namun begitu, Islam Hadhari dilihat gagal memastikan keharmonian dalam hubungan etnik. Hal ini berikutan terdapat banyak kes tentang isu-isu sensitif dan perkauman telah disebut secara terbuka tanpa menghiraukan masyarakat majmuk di Malaysia (Mohd Azizuddin Mohd Sani, 2010). Konsep 1Malaysia pula diperkenalkan untuk membina hubungan kerjasama dan sebagai usaha ke arah mencapai perpaduan kaum (Yusri Mohamad Ramli & Tengku Ghani Tengku Jusoh, 2012). Pada tahun 2020, Menteri di Jabatan Perdana Menteri (Agama) telah memperkenalkan konsep *Rahmatan lil'alamin* bagi membina hubungan yang baik antara masyarakat Islam dan bukan Islam. Walau bagaimanapun, pelbagai isu dan kritikan yang dilakukan oleh pelbagai pihak berkenaan pendekatan ini yang dilihat tidak membela masyarakat Islam tetapi memberi penumpuan kepada kebajikan agama lain. Hal ini menunjukkan pelbagai usaha yang dilakukan bertujuan bagi membina hubungan baik dan kesepaduan sosial dalam masyarakat majmuk di Malaysia. Usaha secara berterusan penting dalam menangani konflik dalam masyarakat majmuk bagi mengelakkan kekecohan dan pergaduhan.

KAWASAN RUKUN TETANGGA

KRT merupakan satu jawatankuasa sukarela yang dinaungi dan dipantau oleh JPNIN di bawah kawalan Kementerian Perpaduan Negara. KRT ditubuhkan selepas peristiwa 13 Mei 1969 yang telah mengorbankan banyak nyawa ekoran isu perkauman. Peristiwa ini telah memberi kesanburuk kepada masyarakat majmuk di Malaysia. Hal ini juga turut menimbulkan sikap prejudis dan curiga sehingga menyebabkan hubungan antara etnik semakin renggang. Oleh sebab itu, KRT merupakan inisiatif pihak kerajaan untuk memupuk kembali kesepaduan dalam hubungan etnik agar keharmonian dapat dicapai. Peristiwa ini memberi kesedaran kepada pelbagai pihak akan kepentingan mengurus hubungan etnik dari peringkat akar umbi (JPNIN, 2022). Ekoran itu, pada 29 Ogos 1975, KRT telah dirasmikan oleh Tun Abdul Razak, Perdana Menteri Malaysia ke dua di KRT Kampung Kasipillay, Kuala Lumpur. KRT ini diwujudkan di bawah Peraturan-Peraturan Perlu (Rukun Tetangga) 1975 (P.U. (A) 279/75) yang diadakan di bawah Ordinan Darurat 1969 (JPNIN, 2022).

Pada awalnya, KRT berfungsi untuk memastikan keselamatan penduduk di kawasan kejiranan dan rondaan wajib telah diperkenalkan kepada penduduk yang berusia 18 hingga 55 tahun (Abd Hadi Mohd Salleh & Norwahidah Zinalibidin, 2013; JPNIN, 2013). Selepas itu, pada tahun 1984, konsep KRT berubah kepada konsep kejiranan yang menjurus kepada program meningkatkan semangat kejiranan dan perpaduan dalam masyarakat setempat (Syed Mahadzir, 2007). Kemudian pada tahun 2001, hala tuju KRT beralih kepada konsep

pembangunan komuniti sejajar dengan perkembangan semasa. Hala tuju baru KRT ini diterjemah melalui komponen KRT yang meliputi Jiran Wanita, Jiran Usia Emas, Jiran Muda dan Tunas Jiran (Fatimah Yassin, 2010). Pada tahun 2010 pula, KRT telah mengalami fasa transformasi selaras dengan Program Transformasi Kerajaan apabila Model Transformasi Rukun Tetangga yang berpaksikan kepada lima teras iaitu perpaduan, ekonomi, keselamatan, pendidikan dan kualiti hidup diperkenalkan. Kini, aktiviti-aktiviti yang dianjurkan oleh KRT berdasarkan teras-teras tersebut. Lima teras ini antara kerangka yang dikenal pasti mampu mencapai matlamat negara untuk melahirkan masyarakat majmuk yang hidup dalam suasana harmonis (Abd Hadi Mohd Salleh & Norwahidah Zinalibidin, 2013).

KRT adalah sebuah organisasi yang menekankan konsep sukarela dan merupakan satu-satunya organisasi sukarela yang ditubuhkan di bawah Akta Parlimen yang diamanahkan dengan beberapa matlamat khusus (JPNIN, 2022; Fatimah Mohd Yasin, 2010; Abd Hadi Mohd Salleh & Norwahidah Zinalibidin, 2013). KRT bertujuan mempromosikan kefahaman dan interaksi dalam masyarakat majmuk di negara ini (Azeem Fazwan Ahmad Farouk & Mohamad Zaini Abu Bakar, 2007). Hal ini bertepatan dengan objektif penubuhan KRT iaitu memelihara, meningkat dan mengukuhkan perpaduan serta integrasi nasional selaras dengan dasar-dasar kerajaan berlandaskan Perlembagaan Persekutuan dan Rukun Negara (JPNIN, 2022). Menurut Afriva Khaidir (2010), KRT mampu bertindak sebagai agen pendamai kerana aktiviti-aktiviti yang dianjurkan dapat memupuk semangat kerjasamadan saling membantu dalam masyarakat majmuk.

SOROTAN KAJIAN

Perhubungan etnik di Malaysia sering dibincangkan dalam empat bentuk iaitu penyesuaian, kerjasama, persaingan dan konflik. Hal ini berikutan hubungan etnik sering berhadapan dengan situasi harmoni ataupun konflik bergantung kepada bentuk interaksi yang wujud dalam kalangan ahli masyarakat (Fatimah Mohd Yasin, 2010). Menurut Shamsul Amri Baharuddin (2008, 2011) keadaan Malaysia boleh dilihat sebagai *a state of stable tension* iaitu keadaan yang stabil walaupun masih wujud ketegangan. Oleh sebab itu, Malaysia sering menjadi perhatian para sarjana dalam mengkaji keempat-empat bentuk hubungan tersebut (Mansor Mohd Noor, Abdul Rahman Abdul Aziz & Mohamad Ainuddin Iskandar Lee, 2006).

Dalam situasi konflik, perhubungan etnik berada dalam keadaan persengketaan dan permusuhan. Kepelbagaian agama, bangsa, bahasa, adat dan sebagainya merupakan asas sentimen yang sentiasa mengikat kepercayaan sesama etnik dalam membentuk identiti kumpulan masing-masing (Hudson, 2006). Situasi ini membentuk semangat kesetiaan sesama etnik seterusnya melahirkan perasaan prejudis dan prasangka buruk terhadap etnik lain (Horowitz, 1985).

Menurut Simmel (1950), konflik adalah menetapkan sempadan antara kumpulan dengan mengukuhkan kesedaran dan mengasingkan daripada kumpulan lain. Coser (1956) pula mentakrifkan konflik sebagai suatu kekuatan nilai-nilai, tuntutan untuk mendapat status, kuasa, sumber dan menjadi tujuan seseorang individu atau kumpulan untuk merosakkan musuh-musuh. Konflik juga bertujuan mengekalkan identiti kumpulan.

Perasaan prejudis dan prasangka buruk dalam masyarakat majmuk boleh mewujudkan konflik etnik. Oleh sebab itu, kajian secara mendalam terhadap punca-punca teretusnya konflik etnik dalam sesebuah negara telah dilakukan oleh ahli sains sosial seperti Geertz (1963), Myron (1966), Wallerstein (1966), Mehden (1969), Tumin (1969), Bullivant (1981),

Horowitz (1985) dan Ooman (1997). Persoalan tentang pola interaksi sosial menjadi perhatian ahli sains sosial ini dalam usaha untuk mencapai integrasi nasional.

Seterusnya, Furnivall (1948) dan Smith (1965) telah mengutarakan konsep masyarakat majmuk yang menjelaskan bahawa masyarakat ini dicirikan oleh pergaduhan dan konflik walaupun berada dalam unit politik yang sama. Masyarakat ini wujud dalam pelbagai bahagian komuniti tetapi hidup secara berasingan. Masyarakat majmuk terdiri daripada pelbagai etnik sebenarnya wujud atas dasar ketegangan dan tidak ada nilai bersama. Hal ini boleh menimbulkan konflik dalam masyarakat majmuk. Namun, Fearon dan Laitin (2003) berpendapat bahawa faktor berlakunya konflik etnik bukan hanya disebabkan faktor etnik dan agama tetapi faktor ketidakseimbangan sosioekonomi, politik yang tidak stabil, populasi penduduk yang ramai dan sebagainya.

Konflik di Myanmar misalnya berlaku kerana faktor agama dan pihak pemerintah melakukan kekejaman dengan melancarkan pembersihan etnik terhadap masyarakat Islam Rohingya. Masyarakat Islam Rohingya tidak diiktiraf sebagai warganegara dan dihalau keluar dari negara sendiri (Abdul Halim Sidek, Yohan Kurniawan & Hishamuddin Md. Som, 2012; Smith, 1994). Manakala, konflik di Afrika Selatan berlaku kerana faktor perbezaan ras. Pihak pemerintah melakukan pengasingan ras mengikut warna kulit ekoran pelaksanaan dasar apartheid pada tahun 1948 sehingga 1994 (Ramli Awang, 2003). Masyarakat kulit hitam telah ditindas secara kejam oleh golongan pemerintah yang terdiri daripada masyarakat kulit putih (Rogers, t.t.). Perang Saudara di Sri Lanka pula berlaku pada tahun 1983 sehingga 2009 berpunca daripada pergaduhan antara etnik majoriti Sinhala dengan etnik minoriti Tamil. Hal ini ekoran etnik Tamil merasa tersisih apabila bahasa Sinhala menjadi bahasa kebangsaan dan agama Buddha menjadi agama rasmi Sri Lanka. Etnik Tamil yang beragama Hindu dan berbahasa Tamil merasa ditindas dan disisihkan. Hal ini telah menimbulkan perasaan tidak puas hati dan menyebabkan berlakunya perang saudara. Konflik ini telah mengakibatkan seramai 150 ribu nyawa telah terkorban (Ng Mooi Ru, 2009; Shamsul Amri Baharuddin, 2011).

Konflik yang berlaku di Palestin, Kemboja, Ireland Utara, Kosovo, Cyprus, Rwanda, Sudan, Peru, Demokratik Republik Congo (DRC), Kashmir, Thailand, Bosnia dan Herzegovina merupakan masalah yang timbul ekoran perbezaan agama, etnik, bahasa dan budaya dalam masyarakat. Perbezaan ini merupakan penyebab berlakunya penindasan, keganasan dan kekejaman terhadap masyarakat yang ditindas terutama golongan minoriti (Wolff, 2006; Young, 1994; Bowen, 1996).

Di Malaysia, kepelbagaian etnik menjadi tumpuan para pengkaji seperti Freedman (1960), Esmam (1972), Horowitz (1983), Sanusi Osman (1989), Fatimah Daud (1984) dan Cheu (1995). Para pengkaji ini telah membuat kajian terhadap hubungan antara pelajar Melayu dan bukan Melayu. Hasil kajian menunjukkan polarisasi semakin meningkat dan hubungan antara pelajar Melayu dan bukan Melayu semakin renggang serta boleh menimbulkan konflik sekiranya tidak dipantau. Agoes Salim (1983) pula meragui keberkesanan Rukun Negara dalam mewujudkan sentimen perpaduan kerana polarisasi kaum semakin meningkat dan hubungan antara kaum semakin menuju kepada kemusnahan. Agoes Salim memberi gambaran keadaan polarisasi ini di kampus-kampus universiti.

Menurut Wan Hashim Wan Teh (1983) dan Hasnah Husin (2010), masalah hubungan etnik berlaku di Malaysia adalah disebabkan oleh dasar penjajah British. Dasar British yang menggalakkan sebilangan besar imigran dari negara India dan China ke Semenanjung bermula awal kurun ke-19. Hal ini diikuti dengan Dasar Pecah dan Perintah yang membawa kepada

pembahagian buruh mengikut pengenalan etnik dan kawasan. Oleh sebab itu, masyarakat Melayu, Cina dan India bukan sahaja terpisah kerana adat, budaya, makanan dan pakaian tetapi turut terpisah dari segi pekerjaan dan tempat tinggal (Graham, 1977).

Kajian yang dilakukan oleh Maurice (1960) pula menunjukkan nilai kebersamaan amat kurang dalam masyarakat Malaysia pada tahun 50-an dan 60-an. Menurut Ting (1982) pula, sebahagian masyarakat majmuk di Malaysia adalah legasi daripada dasar imigrasi penjajah British. Ciri-ciri masyarakat majmuk yang dibentuk pada zaman penjajahan masih kekal hingga hari ini. Chew (1975) pula berpandangan bahawa masyarakat majmuk di Malaysia terpisah dari sudut pendidikan, kuasa ekonomi, penempatan dan politik sebelum kemerdekaan. Namun, selepas mencapai kemerdekaan masyarakat berusaha untuk hidup bersama.

Nur Azuki Yusuff, Nik Yusri Musa dan Wan Sopian Sori (t.t.) telah mengkaji faktor yang menyebabkan konflik etnik di Malaysia. Kajian menunjukkan konflik etnik berpunca daripada pendokong atau kepimpinan politik kepartian dan menyokong parti yang taksub. Kajian ini melihat konflik etnik menurut perspektif mahasiswa. Manakala, kajian Wan Norhasniah Wan Husin (2012) menunjukkan punca berlaku konflik adalah perbezaan nilai-nilai budaya dalam masyarakat majmuk di Malaysia. Kajian ini melihat wujudnya konflik ekoran pertembungan budaya antara masyarakat Melayu dan Cina. Namun begitu, kerajaan telah melaksanakan Dasar Kebudayaan Kebangsaan untuk membina hubungan yang baik dalam kalangan masyarakat majmuk. Kajian berkenaan peranan kerajaan dalam mengurus ketegangan etnik turut dilakukan oleh M. Shamsul Haque (2003). Beliau mengkaji peranan yang dimainkan oleh pihak kerajaan Malaysia dalam menguruskan ketegangan etnik melalui pelaksanaan dasar-dasar dan pembentukan kerajaan yang berasaskan kerjasama politik antara pelbagai etnik.

Oleh sebab itu, perhubungan dalam bentuk kerjasama mempunyai matlamat jangka panjang untuk menyatupadukan masyarakat majmuk (Fearon & Laitin, 1996). Oleh sebab itu, penjelasan teori hubungan etnik perlu memfokuskan kepada kepentingan kerjasama untuk menghindari daripada persengketaan dan menuju ke arah keharmonian. Kajian Willet (1998) pula melihat hubungan kerjasama menjadi pilihan bagi kebanyakan masyarakat majmuk kerana tidak berupaya melenyapkan perbezaan etnik dan menghindarkan konflik yang sering berlaku dalam masyarakat majmuk. Fenomena ini dapat dijelaskan melalui pendekatan akomodasi yang merujuk kepada pengamalan kerjasama, tolak ansur, saling menerima dan menghormati perbezaan budaya antara etnik. Surtahman Kastin Hasan (2008) berpendapat bahawa teras utama kerjasama ialah altruisme iaitu satu sikap yang tidak mementingkan diri sebaliknya mementingkan kebajikan masyarakat. Altruisme dapat melahirkan nilai-nilai mulia seperti bertanggungjawab, bertimbang rasa, kasih sayang, hormat-menghormati, jujur, ikhlas, adil dan sebagainya. Masyarakat majmuk memilih hubungan kerjasama kerana tidak berupaya untuk melenyapkan perbezaan antara etnik dan mengelak daripada berlaku konflik.

Putnam (1993, 1995) menyatakan bahawa salah satu usaha yang berpotensi membina ruang sosial dan budaya kerjasama adalah melalui penglibatan masyarakat dalam institusi sosial seperti berpersatuan dan organisasi. Penglibatan ini tanpa mengira batas budaya, agama dan bangsa. Misalnya, kajian yang telah dilakukan Fatimah Mohd Yasin (2010) menunjukkan bahawa penglibatan masyarakat majmuk dalam aktiviti berpersatuan dapat memupuk sikap saling percaya, menghormati dan bertanggungjawab. Hal ini seiring dengan kajian oleh Korten (1980) dengan melihat pelaksanaan program Savodaya Sharamandana Movement di Sri Lanka bertujuan membangunkan semangat kerjasama dalam kalangan masyarakat setempat. Program ini merupakan contoh organisasi sukarela yang berkesan dalam memberi perkhidmatan kepada

masyarakat setempat. Shek (2007) dan Nurazmallail Marni et al. (2004) turut membincangkan kepentingan amalan kerjasama dalam masyarakat. Kajian Shek (2007) menunjukkan kerja berpasukan merupakan satu cara kerjasama yang berkesan dan perlu diamalkan bermula dari sekolah lagi. Manakala, Nurazmallail Marni et al. (2004) berpendapat bahawa amalan kerjasama yang ditekankan oleh Islam adalah untuk mewujudkan kesatuan dalam masyarakat. Masyarakat perlu bekerjasama bagi membina hubungan baik sesama manusia, membaiki taraf kehidupan dan menegakkan hukum Allah SWT untuk mencapai kejayaan.

Steven (2003) dan Surtahman Kastin Hasan (2008) turut menjelaskan tentang kepentingan kerjasama dalam pembangunan ekonomi. Menurut Steven dan Surtahman Kastin Hasan, masyarakat majmuk perlu berganding bahu bagi membangunkan sektor ekonomi dan bekerjasama dalam isu-isu yang melibatkan kepentingan bersama. Masyarakat yang menjalin hubungan kerjasama mempunyai peluang yang luas untuk mencapai kejayaan dan mampu meningkatkan taraf ekonomi mereka. N. Emel Ganapati, Ilan Kelman dan Theodore Koukis (2010) pula membincangkan kepentingan membina hubungan kerjasama terutama negara-negara yang berkonflik. Hal ini kerana wujud hubungan kerjasama secara jangka panjang antara negara-negara berkonflik apabila berlaku bencana alam. Manakala, James dan David (1996) turut membincangkan kepentingan hubungan kerjasama dalam menyelesaikan persengketaan dan konflik bagi mencapai keamanan. Oleh sebab itu, hubungan kerjasama memainkan peranan penting untuk membina masyarakat yang harmonis. Menurut Ibnu Khaldun (1993), sesebuah dinasti atau kerajaan boleh berkembang luas melalui semangat kerjasama. Semangat kerjasama ini hanya akan wujud apabila setiap anggota masyarakatnya saling menyayangi dan sanggup berjuang serta rela berkorban demi menjaga kepentingan bersama.

PENGURUSAN MASYARAKAT KEPELBAGAIAN DALAM KRT DI MALAYSIA

KRT telah melaksanakan pelbagai aktiviti kemasyarakatan yang bertujuan merapatkan hubungan kejiwaan. Masyarakat kepelbagaian di KRT perlu diuruskan dengan baik dan berstrategi. Maka, KRT telah menguruskan masyarakat kepelbagaian melalui aktiviti-aktiviti kemasyarakatan ini bagi memperkukuh hubungan baik. Aktiviti-aktiviti kemasyarakatan yang dilakukan adalah sebagaimana berikut:

Aktiviti Sosial

Dalam aktiviti sosial misalnya, pelbagai aktiviti dilaksanakan bagi memastikan masyarakat majmuk dapat mengambil bahagian. Hal ini bertujuan membina hubungan kerjasama dalam masyarakat majmuk. Antara aktiviti-aktiviti yang dilakukan ialah sambutan Hari Raya Aidilfitri, Hari Raya Korban, Tahun Baru Cina, Deepavali, Krismas, Hari Keluarga dan lawatan ke KRT lain. Bagi sambutan perayaan, masyarakat KRT saling membantu menghulurkan sumbangan kewangan dan barangan keperluan. Malah mereka turut meluang masa gotong-royong menyediakan juadah makanan untuk para tetamu yang hadir. Aktiviti gotong-royong bagi sambutan perayaan mendapat kerjasama yang baik daripada masyarakat majmuk. Oleh sebab itu, Ibn Khaldun (1993) berpendapat bahawa toleransi wujud dalam bentuk kerjasama dan keperluan berorganisasi. Hal ini kerana manusia perlu berinteraksi bagi memenuhi keperluan bersama. Lantaran itu, peringkat akomodasi penting agar masyarakat majmuk saling menghormati norma dan nilai kumpulan etnik lain. Hal ini seiring dengan pandangan Nurazmallail Marni et al. (2004) bahawa sikap menghormati dan bertolak ansur dapat membina hubungan baik sesama manusia. Selain itu, aktiviti Hari Keluarga diadakan bagi mengeratkan hubungan sesama ahli masyarakat. Hari Keluarga dianjurkan supaya masyarakat

dapat beriadah bersama keluarga dan jiran tetangga. Lazimnya, aktiviti ini dilakukan di hutan lipur, pantai dan sebagainya. Malah, aktiviti sukaneka turut diadakan bagi memeriahkan suasana. Selain itu, aktiviti lawatan ke KRT lain bertujuan menjalin hubungan persahabatan, mengenali perbezaan budaya dan berkongsi pelbagai pengalaman. Oleh sebab itu, aktiviti ini boleh memupuk sikap penerimaan dan menghindari sikap prejudis serta stereotaip terhadap etnik lain. Hal ini seiring dengan pandangan Zarina Muhammad (1997) bahawa amalan toleransi dalam masyarakat majmuk dapat membina hubungan kerjasama dan menghalang daripada berlaku pergaduhan. Aktiviti-aktiviti yang dijalankan mendapat sambutan daripada masyarakat KRT.

Aktiviti Keagamaan

Aktiviti agama merupakan aktiviti yang mendapat sambutan daripada masyarakat KRT antaranya ceramah keagamaan, kursus mandi jenazah, bacaan Yasin, forum, gotong-royong membersihkan rumah ibadat dan perkuburan. Aktiviti-aktiviti ini merupakan inisiatif untuk mendidik individu mendekati agama. Individu yang terdidik dengan agama dapat melahirkan masyarakat yang bertanggungjawab, prihatin dan berakhlak mulia. Kelompok Jiran Muda dan Tunas Jiran merupakan generasi muda yang perlu diberi pendedahan awal tentang aktiviti agama. Masyarakat bukan Islam tidak melibatkan diri dalam aktiviti keagamaan tetapi menghormati aktiviti yang dilakukan oleh masyarakat Islam. Kebiasaanya, aktiviti yang melibatkan ritual keagamaan dilakukan secara berasingan tanpa melibatkan KRT. Hal ini supaya dapat memberi kebebasan untuk melakukan amalan ritual masing-masing Sementara itu, aktiviti membersihkan rumah ibadat dan perkuburan pula turut dilakukan oleh masyarakat KRT. Sebagai contoh KRT Pangsapuri Pelangi, KRT Komtar, KRT Kg. Kolam, Pulau Pinang. Masyarakat Melayu, Cina dan India turut meluangkan masa dan tenaga untuk membersihkan tempat ibadat dan perkuburan. Aktiviti ini dijadikan sebagai aktiviti kemasyarakatan yang tidak melibatkan kepercayaan agama. Aktiviti-aktiviti ini dapat memupuk hubungan saling membantu dalam masyarakat. Aktiviti-aktiviti yang dianjurkan oleh KRT merupakan inisiatif untuk membina hubungan baik dalam kalangan masyarakat. Hal ini seiring dengan pendapat Ibn Khaldun (1993) bahawa toleransi wujud melalui hubungan kerjasama dan penyertaan dalam organisasi. Oleh sebab itu, manusia perlu berinteraksi dan berorganisasi untuk memenuhi keperluan bersama (Ibn Khaldun, 1993).

Aktiviti Kesenian dan Kebudayaan

Aktiviti kesenian dan kebudayaan biasanya dilakukan ketika meraikan majlis-majlis tertentu seperti sambutan perayaan, sambutan kedatangan wakil rakyat, kenduri kahwin dan sebagainya. Aktiviti yang biasa dilakukan adalah kelas seni tari, kraftangan, gubahan, komping, tarian India, tarian Singa, Boria dan pertunjukan pentas. Walau bagaimanapun, aktiviti-aktiviti ini semakin kurang mendapat sambutan oleh Jiran Muda kerana mereka lebih gemar menghabiskan masa lapang di luar. Dalam aktiviti ini, wujud prinsip toleransi apabila masyarakat saling menghormati adat dan kebudayaan etnik lain. Misalnya, KRT Pengkalan Gersik, Johor membuat kelas tarian untuk semua kaum dan KRT Kok Seraya, Tumpat, melaksanakan tarian kebudayaan Siam. Aktiviti ini dapat memberi pendedahan awal kepada Tunas Jiran tentang kepelbagaian etnik, budaya dan adat. Maka, Tunas Jiran dapat memahami, menerima dan menghormati kepelbagaian ini. Namun begitu, aktiviti-aktiviti ini jarang dilakukan kerana Tunas Jiran mengalami kekangan masa ekoran sibuk dengan urusan pelajaran. Oleh sebab itu, Putnam (1993, 1995) menyatakan bahawa penglibatan masyarakat dalam institusi sosial berpotensi membina ruang sosial dan memupuk budaya kerjasama dalam masyarakat majmuk. Fatimah Mohd Yassin (2010) juga turut berpendapat bahawa aktiviti-

aktiviti yang dilakukan oleh KRT dapat memupuk sikap saling menghormati, toleransi, bertanggungjawab dan saling percaya.

Aktiviti Kesihatan dan Alam Sekitar

Aktiviti kesihatan dan alam sekitar merupakan aktiviti yang diadakan setiap tahun. Hal ini bertujuan memberi pendedahan kepada masyarakat tentang kepentingan penjagaan kesihatan dan alam sekitar. Masyarakat luar KRT turut diberi peluang untuk menyertai aktiviti-aktiviti ini. Antara aktiviti-aktiviti yang sering dilakukan adalah kem kesihatan, ceramah kesihatan, seminar kecergasan, kempen kebersihan dan gotong-royong membersihkan alam sekitar. Menurut Pengerusi KRT Kg. Gong Baru, mesyuarat jawatankuasa KRT akan diadakan sebelum melakukan sebarang aktiviti bagi memastikan setiap aktiviti berjalan lancar. Hubungan kerjasama antara KRT dengan pusat kesihatan memberi manfaat kepada masyarakat kerana berpeluang melakukan pemeriksaan kesihatan secara percuma. Nilai kasih sayang dilihat wujud dalam aktiviti kesihatan apabila masyarakat saling membantu golongan yang lemah seperti OKU dan warga tua untuk melakukan pemeriksaan kesihatan. Jiran Muda turut membantu menghantar golongan ini ke pusat kesihatan kerana ketiadaan pengangkutan. Oleh sebab itu, Mahmud Al-Misri (2014) berpendapat kasih sayang adalah sifat yang memberi manfaat kepada individu lain. Hal ini mewujudkan sikap prihatin dan bertanggungjawab ahli masyarakat terhadap golongan yang memerlukan. Manakala Che Bakar Che Mat et al. (2007) menyatakan bahawa prinsip kasih sayang boleh mengikat masyarakat dalam satu ikatan yang kukuh. Pengabaian prinsip ini boleh menyebabkan wujud jurang dalam masyarakat (Djam' annuri, 2000).

Aktiviti Sukan

Aktiviti sukan merupakan aktiviti yang mendapat sambutan daripada semua lapisan masyarakat terutama Jiran Muda. Menurut Pengerusi KRT Kg. Gong Baru, aktiviti sukan merupakan aktiviti yang paling digemari oleh seluruh masyarakat berbanding aktiviti-aktiviti lain. Oleh sebab itu, pelbagai acara sukan dirangka oleh jawatankuasa KRT bagi menarik minat masyarakat terutama Jiran Muda. Aktiviti sukan yang biasa dilakukan adalah sukaneka, futsal, bola jaring, bola tampar, badminton, bola sepak, bola keranjang, sepak takraw dan ping-pong. Aktiviti ini akan dikendalikan oleh ketua kelompok komuniti masing-masing. Kebiasaannya, Jiran Wanita akan mengadakan aktiviti bola jaring, bola tampar dan sukaneka. Manakala, Jiran Muda dan Tunas Jiran akan mengadakan aktiviti bola sepak, futsal, badminton, sepak takraw dan ping pong. Aktiviti ini merupakan inisiatif pihak KRT untuk memupuk sikap menghormati dan mengeratkan hubungan dalam masyarakat majmuk. Aktiviti sukan memberi peluang yang luas kepada masyarakat untuk mengeratkan hubungan kejiwaan. Oleh sebab itu, KRT giat menganjurkan aktiviti sukan dengan menyediakan hadiah dan sijil. Aktiviti ini juga bertujuan menghindari Jiran Muda dan Tunas Jiran daripada terlibat dalam aktiviti tidak berfaedah seperti melepak, merempit, penyalahgunaan dadah, gengsterisme dan sebagainya.

Selain itu, jawatankuasa KRT juga berusaha mencari tajaan bagi menampung kos aktiviti yang akan dilakukan. KRT Pengkalan Gersik, Johor dan KRT Gunung Mas, Negeri Sembilan misalnya berusaha mengumpul dana untuk melaksanakan program kesukanan. Hal ini kerana aktiviti sukan begitu diminati oleh Jiran Muda dan Tunas Jiran. Hal ini menunjukkan sikap tanggungjawab dan kesungguhan ahli jawatankuasa KRT dalam mengalakkan Jiran Muda melakukan aktiviti yang bermanfaat. Aktiviti-aktiviti sukan ini dilihat dapat membina sikap saling menghormati dalam kalangan Jiran Muda. Hal ini seiring dengan pandangan Forrest (2001) bahawa hubungan kejiwaan boleh membina kepercayaan dan sikap menghormati khususnya dalam kalangan golongan muda. Che Bakar Che Mat et al. (2007)

turut berpendapat bahawa sikap menghormati dapat mewujudkan masyarakat yang bersatu padu dan harmoni.

KESIMPULAN

KRT merupakan organisasi sosial yang memainkan peranan penting dalam membentuk kesepaduan sosial kalangan masyarakat kepelbagaian di Malaysia. KRT menjadi titik pertemuan masyarakat kepelbagaian dalam melaksanakan pelbagai program kemasyarakatan. Penglibatan masyarakat secara sukarela dan membina hubungan kerjasama dilihat unik dan mampu memberi impak besar kepada keharmonian dalam negara kita. Secara realitinya masyarakat di Malaysia terdiri daripada pelbagai etnik terutama di kawasan bandar. Maka, ia memerlukan kaedah yang berkesan untuk mengurus masyarakat kepelbagaian. Kewujudan KRT mampu membina hubungan baik dalam masyarakat melalui program yang dilaksanakan secara aktif dan berterusan. Hal ini memberi kesan terhadap tahap hubungan dan memainkan peranan penting dalam mengurus masyarakat kepelbagaian di Malaysia.

PENGHARGAAN

Artikel ini adalah hasil daripada geran penyelidikan. Jutaan terima kasih ditujukan khas untuk Kementerian Pengajian Tinggi (KPT) yang telah menaja penyelidikan ini di bawah Fundamental Research Grant Scheme (FRGS), Grant no.: FRGS/1/2020/SS0/UMK/02/3, Fasa 1, bagi tahun 2020.

RUJUKAN

- Aunur Rafiq (2009). *Pendamaian Menurut Perspektif Al-Qur'an: Analisis tentang Hubungannya dengan Piagam Madinah*. Tesis Doktor Falsafah Usuluddin, Jabatan Al-Quran dan Al-Hadith, Universiti Malaya. Tidak diterbitkan.
- Chamhuri Siwar (1991). *Pembasmian Kemiskinan dalam jangka masa DEB: Beberapa Isu dan Masalah*. Dlm. Khadijah Muhamed & Halimah Awang (Eds.), *Dasar Ekonomi Baru dan Masa Depan*. Kuala Lumpur: Persatuan Sains Sosial Malaysia.
- Chamhuri Siwar (2000). *Kajian Keberkesanan Pendekatan-Pendekatan Pembasmian Kemiskinan di Malaysia*. Kertas kerja yang dibentangkan dalam *Muzakarah Penggubal Model Pembasmian Kemiskinan Menurut Perspektif Islam* di Universiti Kebangsaan Malaysia, Bangi.
- Chamil Wariya (1987). *Politik Kompromi: Satu Tinjauan Kerjasama Melayu dengan Bukan Melayu di Malaysia*. Kuala Lumpur: 'K' Publishing & Distributors.
- Chamil Wariya (2007). *Malaysia 50 Fakta Asas Kenegaraan*. Kuala Lumpur: Media Global Matrix.
- Fadilah Zaini & Kassim Thukiman (2009). *Pembangunan Politik dalam Hubungan Etnik*.
- Fatimah Mohd Yasin (2010). *Interaksi Etnik dalam Organisasi Sosial: Kajian terhadap Rukun Tetangga di Pulau Pinang*. Tesis Sarjana, Universiti Sains Malaysia. Tidak diterbitkan.
- Fearon, J. D. & Laitin, D. D. (1996). *Explaining Interethnic Cooperation*. *American Political Science Review*, 90(4), 715-735.
- Guillaume, A. (2004). *The Life of Muhammad*. Karachi: Oxford University Press.
- Ibnu Khaldun (1993). *Mukadimah Ibn Khaldun* (Terj. Dewan Bahasa dan Pustaka). Kuala Lumpur: Dewan Bahasa dan Pustaka.
- Ishak Saat (2005). *Sejarah Sosial Masyarakat Malaysia*. Shah Alam: Karisma Publication.

- Ishak Saat (2009). *Sejarah Panjang Hubungan Malaysia-China*. Kertas kerja yang dibentangkan dalam Seminar 35 Tahun Hubungan diplomatik Malaysia dengan China di Beijing Foreign Studies University, Beijing, China pada 29 Mei-4 Jun 2009.
- Khairul 'Azmi Mohamad & Nooraini Othman (2009). Minda Hadhari dalam Mencapai Matlamat Islam Hadhari. Dlm. Khairul 'Azmi Mohamad et al., (Eds.), *Ke arah Umat Hadhari*. Kuala Lumpur: Yayasan Ilmuan.
- Korten, D. C. (1980). Community Organization and Rural Development. A Learning Process Approach. *Public Administration Review*, 40, 242-249. Kuala Lumpur: Pustaka Al-Mizan.
- Mansor Mohd Noor, Abdul Rahman Abdul Aziz & Mohamad Ainuddin Iskandar Lee (2006). *Hubungan Etnik di Malaysia*. Selangor: Pearson Malaysia.
- Mohd Azizuddin Mohd Sani (2010). The Politics of Islam Hadhari and Ethnic Relations in Malaysia. Dlm. Maya Khemlani David et al. (Eds.), *Ethnic Relations and Nation Building the Way Forward* (47-71). Petaling Jaya: Strategic Information and Research Development Centre.
- Nik Mustapha Nik Hassan (2009). Memahami Pendekatan Islam Hadhari. Dlm. Khairul 'Azmi Mohamad et al. (Eds.), *Ke arah Umat Hadhari*. Kuala Lumpur: Yayasan Ilmuan.
- Nurazmallail Marni et al. (2004). Amalan Bekerjasama dalam Komuniti Setempat: Kepentingannya Menurut Perspektif Islam. Kertas kerja yang dibentangkan dalam Seminar Antarabangsa Nilai dalam Komuniti Pasca Modenisme (SIVIC 2004), Universiti Utara Malaysia, Kedah pada 4-6 September 2004.
- Putnam, R. D. (1993). *Making Democracy Work, Civic Traditions in Modern Italy*. Princeton: Princeton University Press.
- Putnam, R. D. (1995). Tuning In, Tuning Out: The Strange Disappearance of Social Capital in America. *PS: Political Science & Politics*, 28(4), 664-683.
- A. Rahman Ahmad Jerlun (1990). *Rukun Islam Formula Perpaduan Ummah*. Kuala Lumpur: Dewan Bahasa dan Pustaka.
- Shamsul Amri Baharuddin (2008). Hubungan Etnik di Malaysia: Mencari dan Mengekal Kejernihan dalam Kekeruhan. *Siri Kertas Kajian Etnik UKM*, 1(November), 6-22.
- Shamsul Amri Baharuddin (2011). Kesepaduan dalam Kepelbagaian. Perpaduan di Malaysia sebagai work-in-progress. Bangi: Universiti Kebangsaan Malaysia.
- Shamsul Amri Baharuddin (Ed.) (2012). *Modul Hubungan Etnik Edisi Kedua*. Bangi: Institut Kajian Etnik, UKM.
- Shek Kwai Fun (2007). Keberkesanan Kerja Berpasukan dan Kepuasan Kerja Ketua Panitia dalam Jabatan Bahasa dan Sains Sosial di Sekolah Menengah Daerah Pontian. Tesis Sarjana, Universiti Teknologi Malaysia.
- Steven, C. D. (2003). Cooperation for Community Economic Development. *Community Economics* (Oktober), 1-2. Diakses pada 12 Disember 2012 daripada <http://www.aae.wisc.edu/pubs/cenews/docs/ce324.pdf>.
- Surtahman Kastin Hasan (2008). *Kerjasama Ekonomi Umat Islam Potensi dan Cabaran*. Kuala Lumpur: Dewan Bahasa dan Pustaka.
- Watt, W. M. (1956). *Muhammad at Medina*. London: Oxford University Press.
- Yahaya Jusof (2014). *Sejarah Falsafah Politik dalam Islam*. Johor Bahru: Universiti Teknologi Malaysia.
- Yusri Mohamad Ramli & Tengku Ghani Tengku Jusoh (2012). Najib Razak's 1Malaysia and Charter of Medina's One Ummah: Comparative Perspective. *International Journal of Business and Social Science*, 3(2), 95-101.

Beberapa Elemen Terapi Tasawwuf Berdasarkan Doa Nabi Ibrahim AS

Farah Mohd Ferdaus
Pusat Kajian Al-Quran dan Sunnah, UKM
p106932@siswa.ukm.edu.my

Hamdi Ishak
Pusat Kajian Al-Quran dan Sunnah, UKM
hamdi@ukm.edu.my

Mohd Manawi Mohd Akib
Pusat Kajian Al-Quran dan Sunnah, UKM
manawi@ukm.edu.my

ABSTRACT

Every human being has a combination of spiritual and physical elements within themselves. A healthy physical is a result of good spiritual wellness. These two elements complement each other to get the continuity and happiness of a prosperous life. The strength of the the spiritual component within oneself is synonymous with the strengthening of a healthy psychospiritual as Prophet Ibrahim as strengthened the psychospiritual in his prayers. His firm belief in Allah SWT in praying to him led to a good personality. This article discusses about the psychospiritual elements found in the prayers of the Prophet Ibrahim as in Quran. The selection of the psychospiritual element was chosen through the Islamic Psychospiritual Therapy Method. This study analyzed using content analysis methods through research on literature literacy. The results found that the verses of the Quran related to the prayers of Prophet Ibrahim as have psychospiritual elements based on Psychotherapy Method of Iman, Pschotherapy Method of Worship and Psychotherapy Method of Tasawwuf.

Keywords: *psychospiritual; prayer; Prophet Ibrahim as; psychotherapy method*

ABSTRAK

Setiap manusia mempunyai gabungan elemen rohani dan jasmani dalam diri. Fizikal yang cergas adalah bersumberkan daripada rohani yang sihat. Kedua-dua elemen ini saling melengkapi di antara satu sama lain bagi mendapatkan kelangsungan dan kebahagiaan hidup yang sejahtera. Kekuatan elemen kerohanian dalam diri manusia adalah sinonim dengan psikospiritual yang sihat sebagaimana Nabi Ibrahim as mengukuhkan psikospiritual di dalam doanya. Keyakinan beliau yang tinggi terhadap Allah SWT dalam berdoa kepadanya mendorong kepada pembentukan keperibadian yang baik. Artikel ini membincangkan elemen psikospiritual yang terdapat pada doa Nabi Ibrahim as di dalam Al-Quran. Pemilihan elemen psikospiritual yang dipilih adalah daripada Kaedah Terapi Psikospiritual dalam Islam. Kajian ini dianalisis menggunakan kaedah analisis kandungan melalui penelitian terhadap literasi kepustakaan. Hasil dapatan kajian mendapati bahawa ayat-ayat Al-Quran berkaitan doa Nabi Ibrahim as mempunyai elemen psikospiritual berdasarkan Kaedah Psikoterapi Iman, Kaedah Psikoterapi Ibadah dan Kaedah Psikoterapi Tasawwuf.

Kata Kunci: *psikospiritual; doa; Nabi Ibrahim as; kaedah psikoterapi*

PENDAHULUAN

Psikospiritual merupakan salah satu bidang ilmu dalam Islam yang terbentuk daripada gabungan psikologi dan spiritual yang berasaskan daripada ilmu tasawuf atau bidang kerohanian dalam agama. Bidang ini mengaitkan antara pembicaraan fizikal, mental, emosi

dan spiritual iaitu elemen kerohanian dan kejiwaan yang mendorong kepada konteks ibadah kepada Allah SWT (Che Zarrina Sa'ari²⁰¹⁹). Bidang ini juga membuktikan hubungkait di antara proses mental, pengalaman dan sikap manusia dengan ilmu metafizik dan psikologi. Dalam disiplin keilmuan Islam, perbincangan psikospiritual turut menjurus kepada konsep pengabdian dan penyerahan diri kepada Allah SWT. Matlamatnya adalah untuk merawat kejiwaan atau kerohanian berasaskan sumber ketuhanan yang mampu melahirkan kestabilan diri dan jiwa manusia (Mohd Shahril Othman 2014). Oleh itu, psikospiritual Islam didefinisikan sebagai suatu konsep dan kaedah dalam perawatan jiwa, spiritual, mental, emosi serta perilaku moral.

Psikospiritual adalah gabungan bagi sebuah gagasan ilmu psikologi dan spiritual. Menurut (Dewan Bahasa dan Pustaka 2015), psiko dikenali daripada perkataan psikologi yang merujuk kepada disiplin ilmu tentang kajian berkaitan proses mental dan pemikiran yang berhubung dengan perilaku manusia. Ia juga merupakan ilmu pengetahuan yang menggabungkan masalah-masalah yang dihadapi oleh manusia dalam kehidupan seharian serta rawatan terhadap masalah tersebut. Spiritual pula berkaitan dengan jiwa serta bersifat rohani semata. Menurut *American Psychological Association* (APA), faktor spiritual difahamkan sebagai ajaran moral, agama serta kepercayaan yang mempengaruhi perkembangan perilaku, emosi mahupun mental seseorang. Spiritual juga dijelaskan sebagai tapak asas bagi suatu perasaan yang tertumpu kepada jiwa, Tuhan serta sensitiviti dalam pengalaman untuk pembangunan fizikal yang sejahtera. Sebagai seorang hamba, perawatan jiwa dan rohani yang berasaskan kepada manual yang telah ditetapkan oleh Allah SWT merupakan salah satu wasilah bagi mengukuhkan jiwa dan roh seseorang manusia daripada penyelewengan.

Antara contoh ibadah bagi perawatan jiwa adalah ibadah doa. Ibadah kerohanian ini merupakan suatu bentuk permohonan, pengharapan, penghayatan serta komunikasi seorang hamba kepada pencipta (Rahmat Firdaus 2019). Oleh itu, pendekatan ibadah ini merupakan elemen penting bagi membentuk jiwa yang murni, berkasih sayang, saling hormat menghormati serta mendapat ketenangan dalam hidup (Mohd Nasir bin Masroom & Wan Ismail Wan Dagang 2013). Justeru itu, terdapat hubungkait di antara doa Nabi Ibrahim as dalam mengukuhkan psikospiritual berdasarkan kepada ketauhidan baginda yang diuji dengan masalah moral dan sosial dalam kalangan kaum baginda. Hal ini berkait dengan kehidupan psikososial kaumnya yang menyimpang daripada akidah sekaligus mempengaruhi kehidupan psikospiritual mereka. Dengan mengaplikasikan elemen psikospiritual yang khusus dalam diri akan membawa kepada langkah intervensi yang holistik dari segi emosi, spiritual dan psikologi. Oleh itu, penulis akan membincangkan berkaitan pengukuhan psikospiritual berdasarkan kepada doa Nabi Ibrahim as yang terdapat pada *Surah Al-Baqarah*, *Surah Ibrahim*, *Surah As-Syu'ara*, *Surah As-Saffat* dan *Surah Al-Mumtahanah*.

KAEDAH PSIKOSPIRITUAL DALAM ISLAM

Psikospiritual merupakan asas bermulanya kepada proses di antara pemikiran dan jiwa yang akan membentuk kepada tingkah laku manusia. Setiap proses yang dibentuk akan membawa kepada tingkah laku yang positif ataupun negatif. Oleh itu, bagi setiap permasalahan yang berlaku seperti penyakit jiwa, maka ia memerlukan kepada rawatan berbentuk spiritual seperti kaedah terapi psikospiritual. Terapi psikospiritual merupakan pendekatan yang menggabungkan antara agama dan kerohanian menjadi psikoterapi (Nazrin Asyraf Adeeb M & Rafidah Bahari 2017). Ia juga dikenali sebagai intervensi psikologi secara praktikal dalam menyembuhkan penyakit jiwa seperti kecelaruan emosi, kognitif dan tingkah laku manusia berasaskan kepada ajaran Al-Quran dan sunnah (Che Zarrina Sa'ari 2019). Tambahan pula, kaedah terapi psikospiritual dalam Islam merupakan rawatan bersifat kerohanian yang

menerapkan amalan-amalan yang tidak bertentangan dengan syariah Islam dan berunsur ketuhanan. Rawatan ini memfokuskan kepada penyucian jiwa, pembentukan jati diri yang baik selari dengan pemantapan rohani bagi mendapatkan keredhaan Allah SWT (Rosni Wazir, Abur Hamdi Usman, Syamim Zakwan Rosman, Suriani Sudi et al. 2020). Dalam pada itu, pemulihan spiritual dan kejiwaan memerlukan kepada kaedah terapi yang bersifat spiritual. Hal ini dapat dilakukan jika hubungan antara manusia dengan penciptaNya terpelihara (Muhd Afiq Abd Razak & Mohd Syukri Zainal Abidin 2020). Justeru itu, antara kaedah psikoterapi yang dipilih ialah Kaedah Psikoterapi Iman, Kaedah Psikoterapi Ibadah dan Kaedah Psikoterapi Tasawwuf.

Kaedah Psikoterapi Iman

Kaedah ini merupakan asas bagi kaedah terapi psikospiritual Islam yang memfokuskan keimanan kepada Allah SWT. Kaedah ini berasaskan kepada keyakinan yang tinggi yang mesti diperoleh daripada ilmu secara teori, pengamatan melalui pancaindera dan penelitian serta penghayatan mengikut panduan yang telah ditetapkan dalam Islam (Siti Norlina Muhamad 2018). Antara terapi utama yang perlu diaplikasikan dalam kaedah ini ialah melalui Rukun Iman (Che Zarrina Sa'ari 2019). Justeru itu, bagi mengaplikasikan kaedah ini, individu tersebut mestilah melaksanakan segala perintah Allah SWT dan sentiasa berserah diri kepada-Nya dalam apa jua keadaan (Siti Norlina Muhamad 2018). Kebergantungan kepada Allah SWT dalam setiap keadaan akan meningkatkan keyakinan dalam diri manusia bagi menghadapi kehidupan.

Antara perkara utama dalam kaedah ini adalah untuk mendekati dan mengenali Allah SWT melalui kekuasaannya dalam sifat-sifat Allah SWT mahupun nama-nama Allah SWT (*asma-ul husna*) (Sapora Sipon & Ruhaya Hussin 2019). Secara tidak langsung, keimanan dan kepercayaan kepada Allah SWT akan berputik di dalam jiwa individu. Perkara ini juga ada disebutkan di dalam Al-Quran pada Surah Al-Isra' (17:110):

قُلْ ادْعُوا اللَّهَ أَوْ ادْعُوا الرَّحْمَنَ ۗ أَيًّا مَا تَدْعُوا فَلَهُ الْأَسْمَاءُ الْحُسْنَىٰ ۗ...

Maksudnya: *Katakanlah (Muhammad), "Serulah Allah atau serulah Ar-Rahman. Dengan nama yang mana sahaja kamu dapat menyeru, kerana Dia mempunyai nama-nama yang terbaik (Asmaul Husna)..."*

Selain itu, keimanan yang kukuh terhadap qada' dan qadar Allah SWT dapat menjadikan seseorang tabah serta tidak mudah putus asa dalam menghadapi ujian hidup (Norhafizah Musa & Che Zarrina Sa'ari 2019). Menurut (Norhafizah Musa, Azahar Yaakub @ Ariffin, Siti Suhaila Ihwani & Adibah Muhtar et al. 2018), dengan memupuk perasaan reda dengan ketentuan serta qada' dan qadar Allah SWT, ia dapat meningkatkan keimanan dalam jiwa seseorang Muslim. Hal ini dapat dibuktikan seperti pengkisahan Maryam semasa hayatnya, di mana kekuatan imannya adalah dengan kebergantungan hidup yang tinggi kepada Allah SWT serta qada' dan qadarnya (Najah Nadiah Amran & Haziyah Hussin 2020).

Di samping itu, kaedah psikoterapi ini boleh diaplikasikan kepada pesakit yang mempunyai masalah kecelaruan jiwa atau spiritual melalui pendedahan ilmu berkaitan Al-Quran dan hadis serta logik akal bagi mewujudkan keimanan dalam hati mereka (Siti Norlina Muhamad 2018). Hal ini kerana keimanan dalam diri tidak akan terbentuk tanpa kefahaman mahupun perlaksanaan terhadap segala perintah Allah SWT. Oleh itu, jiwa seorang muslim yang mempunyai iman dalam diri mereka akan sentiasa berasa tenang serta dapat meningkatkan keyakinan dalam menghadapi segala masalah dan ujian dalam kehidupan (Rahmadan Arifin 2020). Justeru itu, kaedah ini dilihat mampu meningkatkan ketenangan dalam jiwa individu bagi meneruskan kehidupan dengan baik dan secara tidak langsung beroleh kehidupan yang bahagia di dunia mahupun di akhirat.

Kaedah Psikoterapi Ibadah

Kaedah Psikoterapi Ibadah adalah suatu usaha untuk mendekatkan diri kepada Allah SWT melalui ibadah bagi mendapatkan kekuatan *ruhiyyah* dalam diri seterusnya dapat mencetuskan keimanan yang baik (Siti Norlina Muhamad 2018). Kaedah ini memfokuskan kepada metode “*takhalli*” menurut Al-Ghazali yang merujuk kepada pembersihan diri daripada segala sifat yang keji yang boleh membawa kepada kecelaruan dalam jiwa. Hal ini dapat dibentuk dengan kesedaran yang timbul dalam diri seseorang individu bagi mengosongkan hati mereka daripada sifat yang keji agar dapat berkomunikasi terus dengan penciptaNya (Che Zarrina Sa'ari 2019). Selain itu, proses ini juga memerlukan kepada kesungguhan dalam diri bagi membentuk peribadi yang mulia dengan melaksanakan perintah Allah SWT dan rasulnya seperti solat sunat, melakukan amal soleh serta zikir secara konsisten dan ikhlas (Emie Sylviana Mohd Zahid 2019). Seterusnya menurut kajian daripada (Rahmadan Arifin 2020), antara kaedah psikoterapi yang boleh diaplikasikan berkaitan ibadah adalah seperti mendirikan solat sama ada solat fardhu atau sunat, berpuasa, zikir dan membaca Al-Quran serta berdoa kepada Allah SWT. Menurut kajian daripada (Emie Sylviana Mohd Zahid 2019), beliau telah menukilkan pandangan daripada Hassan Langgulung (1983) bahawa bermujahadah dengan ibadah formal seperti solat, zakat, zikir, doa dan tilawah Al-Quran merupakan kaedah psikoterapi yang paling efektif. Oleh itu, kaedah ini dilihat memfokuskan kepada perbuatan yang perlu dipraktikkan bagi mencapai ketenangan dalam jiwa.

Di samping itu, kaedah psikoterapi ibadah ini berkait dengan kaedah *Al-Syifa'* yang dibawa oleh Ibnu Qayyim iaitu berkaitan terapi hati. Menurut kajian (Norhafizah Musa & Che Zarrina Sa'ari 2019), mereka menghuraikan bahawa terapi hati ini boleh diaplikasikan dengan berdoa, membaca ayat Al-Quran dan berzikir. Kaedah ini mampu memberikan penawar bagi mencapai tingkah laku yang positif. Hal ini kerana, menurut Imam Al-Ghazali (1988M), hati merupakan permulaan bagi penggerak tingkah laku iaitu segala perilaku manusia bermula dengan arahan terus daripada hati (Fariza Md Sham, Salasiah Hanim Hamjah & Mohd. Jurairi Sharifudin 2017). Oleh itu, hati yang tidak tunduk kepada suatu yang bersifat keduniaan akan lebih mudah untuk mendapat ketenangan yang hakiki (Norhafizah Musa & Che Zarrina Sa'ari 2019). Dalam pada itu, usaha bagi mendapatkan ketenangan jiwa dan kestabilan emosi memerlukan kepada penghayatan dalam amalan serta berterusan dalam melakukan amalan tersebut.

Kaedah Psikoterapi Tasawwuf

Para sufi mentakrifkan tasawwuf kepada tiga bahagian iaitu yang pertama, berdasarkan syariat Islam sebagai undang-undang, kedua sebagai kaedah perjalanan rohani manakala yang terakhir sebagai hakikat yang menjadi matlamat kepada kebenaran (Che Zarrina Sa'ari 2019). Kaedah psikoterapi tasawwuf merupakan salah satu penghayatan akidah Islam yang boleh mempengaruhi dan memberi kesan kepada seseorang serta dapat membantu dalam mewujudkan kesihatan mental yang baik (Ahmad A'toa' Bin Mokhtar & Mardiana Binti Mohd Noor 2021).

Antara kaedah tasawwuf yang digariskan dalam kajian ini adalah kaedah *maqamat* menurut Abu Talib Al-Makki iaitu suatu terapi berbentuk spiritual yang merupakan salah satu kaedah terbesar dalam ilmu tasawwuf. Beliau telah membahagikan kaedah ini kepada sembilan peringkat, bermula dengan *maqam taubah, sabar, syukur, raja', khauf, zuhud, tawakkal, rida* dan *mahabbah* (Sharifah Basirah Syed Muhsin & Che Zarrina Sa'ari 2015)(Al-Makki, Abu Talib 1997). Menurutnyanya, kesemua *maqam* ini perlu dilakukan bagi mendapatkan ketenangan dan kebahagiaan hidup di dunia dan di akhirat. Bermula dengan *maqam taubah*, iaitu dengan menyucikan diri daripada segala dosa dan tidak akan mengulanginya. Seterusnya ke *maqam*

yang kedua iaitu dengan menanamkan sifat sabar dalam diri daripada segala hawa nafsu. *Maqam* yang ketiga ialah dengan mensyukuri segala nikmat kurniaan Allah SWT kemudian sentiasa bersangka baik kepada Allah SWT dengan memberikan sepenuh pengharapan hanya kepadaNya melalui *maqam raja*'. Seterusnya adalah dengan menitikberatkan ilmu bagi memperoleh *maqam khauf* dalam diri. Peringkat seterusnya iaitu *maqam zuhud* ditakrifkan sebagai melaksanakan keperluan dunia untuk kepentingan di akhirat. Setelah itu, melalui *maqam tawakal* iaitu dengan memiliki kebergantungan yang tinggi kepada Allah SWT. Seterusnya, dengan menanamkan dalam diri perasaan reda terhadap sesuatu yang berlaku. Terakhir sekali melalui *maqam mahabbah* iaitu dengan menanamkan perasaan kasih dan cinta kepada Allah SWT. (Sharifah Basirah Syed Muhsin & Che Zarrina Sa'ari 2015)(Al-Makki, Abu Talib 1997). Oleh itu, kesemua peringkat ini dilihat merupakan suatu jalan kerohanian untuk mendapatkan *makrifah* daripada Allah SWT bagi kedamaian hidup di dunia dan di akhirat.

DOA NABI IBRAHIM AS BERKAITAN KAEDAH PSIKOTERAPI IMAN

Surah Al-Baqarah (2: 126), Surah Ibrahim (14: 35), Surah Ibrahim (14: 37), Surah Al-Syu'ara (26: 83) & Surah As-Saffat (37: 100).

Kaedah Psikoterapi Iman merupakan suatu kaedah terapi yang berkait dengan spiritual manusia yang melibatkan kepada keyakinan yang kuat yang dimiliki oleh seseorang individu. Kaedah ini merupakan asas kaedah psikoterapi yang memfokuskan kepada keimanan atau kepercayaan kepada Allah SWT. Keyakinan yang dimiliki akan melahirkan kepada keyakinan yang sempurna dengan berasaskan kepada ilmu, pengamatan pancaindera serta penghayatan yang berpandukan Islam (Siti Norlina Muhamad 2018). Seperti doa Nabi Ibrahim as, baginda memohon kepada Allah SWT dengan penuh keyakinan yang tinggi agar negeri Mekah dapat menjadi sebuah negeri yang aman yang mana pada asalnya negeri itu merupakan sebuah negeri yang kering, tandus mahupun tiada tanaman di sana. Akan tetapi, atas dasar ketakwaan dan keyakinan yang tinggi kepada Allah SWT, baginda tetap memohon agar negeri Mekah aman dan selamat bagi melaksanakan ibadah di sana. Sehubungan dengan itu, permohonan Nabi Ibrahim as pada ayat ini dilihat munculnya perasaan yakin dalam diri baginda bahawa segala ketetapan dan takdir adalah daripada Allah SWT.

DOA NABI IBRAHIM AS BERKAITAN KAEDAH PSIKOTERAPI IBADAH

Surah Al-Baqarah (2: 127-128) & Surah Ibrahim (14: 37)

Kaedah Psikoterapi Ibadah ialah suatu kaedah secara praktikal yang mesti dilaksanakan bagi mendapatkan ketenangan jiwa, keteguhan mental dan spiritual mahupun kekuatan fizikal yang akan dipersembahkan. Dengan melaksanakan ibadah, manusia akan merasa lebih dekat dengan penciptanya. Hal ini kerana pendekatan diri kepada Allah SWT melalui ibadah akan mewujudkan kekuatan *ruhiyyah* dalam diri (Siti Norlina Muhamad 2018). Setiap doa Nabi Ibrahim as yang terdapat di dalam Al-Quran merupakan suatu ibadah rohani kepada Allah SWT pada ketika baginda menghadapi dugaan dan ujian dalam kehidupan. Walaupun baginda seorang rasul yang mulia, baginda tetap mempunyai pengharapan dan pergantungan yang tinggi kepada Allah SWT dengan melaksanakan ibadah. Disamping itu, pada *Surah Al-Baqarah* ayat ke 128 telah menggariskan kepentingan ibadah yang telah dimohon oleh Nabi Ibrahim as selepas membangunkan semula Ka'abah pada ketika itu. Baginda telah berdoa kepada Allah SWT agar menunjukkan perlaksanaan ibadah khusus bagi keturunannya yang akan datang terutama sekali bagi mereka yang mengunjungi Baitullah tersebut. Hal ini dapat

dilihat bahawa perlaksanaan ibadah ini merupakan suatu tuntutan yang mesti dilaksanakan bagi menangani masalah kejiwaan sekaligus dapat mencapai kesejahteraan hidup yang sempurna.

DOA NABI IBRAHIM AS BERKAITAN KAEDAH PSIKOTERAPI TASAWWUF

Taubah

Surah Al-Baqarah (2: 127-128), *Surah Ibrahim* (14: 40-41), *Surah Al-Mumtahanah* (60: 4) & *Surah Al-Mumtahanah* (60: 5)

Maqam Taubah merupakan suatu *maqam* atau tempat pertama sebelum menuju ke jalan kerohanian (Al-Makki 1997). *Maqam* ini adalah pangkalan utama yang perlu ditempuh untuk menuju kepada Allah SWT. Menurut (Al-Makki 1997), antara salah satu cara yg penting dalam bertaubat adalah sentiasa berdoa agar diampunkan segala dosa dan mestilah diiringi dengan perbuatan baik yang lain. Hal ini dapat dibuktikan pada doa Nabi Ibrahim as dalam Al-Quran, baginda menutup doanya dengan memohon taubat kepada Allah SWT setelah membangunkan semula Ka'abah pada ketika itu. Pembangunan ini adalah suatu perbuatan baik yang mana Ka'abah merupakan pusat ibadah bagi umat Islam di seluruh dunia sehingga kini. Justeru itu, melalui doa Nabi Ibrahim as tersebut, *maqam* taubat dilihat sebagai suatu proses utama dalam penyucian jiwa dan perubahan spiritual sehingga mencapai kepada tahap peningkatan kualiti diri. Natijahnya, Ka'abah sehingga kini merupakan suatu tempat untuk mensucikan diri daripada dosa serta tempat untuk memohon taubat kepada Allah SWT bagi setiap umat Islam disebabkan oleh nilai keimanan dan adab kenabian yang tinggi Nabi Ibrahim as terhadap Allah SWT.

Sabar

Surah As-Syu'ara' (26: 86)

Sabar ialah suatu *maqam* bagi seseorang untuk menahan diri daripada hawa nafsu sekaligus memaksa diri untuk sentiasa tekun dalam beramal. Individu yang melepasi *maqam* ini akan tetap bersungguh dalam mengharungi ujian dalam kehidupan. Menurut Abu Talib Al-Makki (1997), definisi sabar dalam Al-Quran terbahagi kepada dua keadaan iaitu sabar daripada melakukan kemungkaran dan sabar dalam menegakkan keadilan. Jika disorot kembali hubungannya dengan doa Nabi Ibrahim as, baginda dilihat telah melepasi *maqam* sabar dalam menegakkan agama tauhid terutamanya daripada kalangan keluarganya sendiri. Dalam doanya, baginda telahpun menegur perbuatan bapanya yang menyekutukan Allah SWT dengan menyembah berhala, akan tetapi tegurannya tidak diendahkan lalu baginda tetap bersabar dan memohon ampun kepada Allah SWT untuk bapanya itu. Hal ini bukanlah suatu keadaan yang boleh diterima dek akal bagi kita sebagai seorang manusia biasa, namun begitu perihal yang ditunjukkan oleh Nabi Ibrahim as dalam melepasi *maqam* sabar ini boleh dijadikan ikutan bagi setiap umat Islam.

Syukur

Surah Al-Baqarah (2: 129), *Surah Ibrahim* (14: 38-39), *Surah Ibrahim* (14: 40-41) & *Surah Al-Mumtahanah* (60: 5)

Maqam Syukur merupakan suatu keadaan ketika mana kita memperlihatkan atau menzahirkan setiap nikmat kurniaan yang dimiliki adalah daripada Allah SWT. Menurut Al-Makki (1997),

terdapat tiga keadaan pada *maqam* syukur iaitu syukur melalui lisan, syukur melalui hati dan syukur melalui anggota badan. Berdasarkan daripada doa Nabi Ibrahim as pada *Surah Ibrahim* ayat ke 38-39, baginda menzahirkan rasa syukur melalui lisan dengan memuji Allah SWT di atas kurniaan zuriat pada usia tua baginda.

Raja'

Surah Al-Baqarah (2: 127-128), *Surah Ibrahim* (14: 35), *Surah As-Syu'ara'* (26: 84) & *Surah As-Saffat* (37: 100)

Raja' ialah suatu *maqam* yang menunjukkan kepada kekuatan keinginan seseorang terhadap sesuatu ketika bermohon kepada Allah SWT. *Maqam raja'* akan muncul dalam hati seseorang jika ia mempunyai iman yang tinggi kepada Allah SWT dan bersungguh-sungguh dalam melaksanakan perintahNya selain berhijrah kepadaNya (Al-Makki 1997). Hal ini berkait dengan doa Nabi Ibrahim as ketika baginda memohon kepada Allah SWT dengan bersungguh-sungguh agar diterima segala amal dan ibadahnya setelah selesai melaksanakan perintah Allah SWT dengan membangunkan semula Ka'abah pada ketika itu.

Khauf

Surah As-Syu'ara' (26: 83)

Maqam khauf ialah suatu *maqam* yang berkait dengan *maqam* ilmu. Menurut Al-Makki (1997), *maqam* ini dikategorikan sebagai hakikat kepada ilmu, iman dan takwa. Berdasarkan kepada doa Nabi Ibrahim as, baginda telah memohon kepada Allah SWT agar dikurniakan ilmu pengetahuan dalam mengenali sifat-sifat Allah SWT mahupun hukum berkaitan agama Allah SWT. Lalu, baginda menutup doanya dengan memohon kepada Allah SWT agar dihimpunkan bersama orang-orang soleh di akhirat kelak. Doa baginda ini meliputi seluruh aspek *maqam khauf* merangkumi hakikat ilmu, iman mahupun takwa.

Zuhud

Surah As-Syu'ara' (26: 85)

Maqam zuhud dapat dicapai dengan meninggalkan segala keinginan yang bersifat keduniaan dan melaksanakan segala perintah Allah SWT dengan bersungguh-sungguh. Hakikat *zuhud* menurut Al-Makki (1997) adalah berasa puas dengan perkara yang telah dimiliki, reda dengan keadaan yang ditempuhi serta menganggap bahawa dunia ini sebagai sampingan sahaja. Melalui doa Nabi Ibrahim as yang dirakamkan di dalam *Surah As-Syu'ara'* ayat ke 85, baginda dilihat telah melepasi *maqam zuhud* setelah meninggalkan segala yang dimiliki dan berhijrah ke tempat yang lebih baik untuk menyebarkan agama tauhid. Lalu, baginda memohon kepada Allah SWT agar tergolong dalam kalangan penghuni syurga yang penuh kenikmatan di dalamnya semasa di akhirat kelak. Hal ini bersesuaian kerana baginda telah melaksanakan keperluan hidup di dunia dengan sebaiknya untuk kepentingan akhirat.

Tawakkal

Surah Ibrahim (14: 37), *Surah As-Saffat* (37: 100) & *Surah Al-Mumtahanah* (60: 4)

Tawakkal adalah suatu kebergantungan dan keyakinan seseorang sepenuhnya terhadap Allah SWT beserta keimanan kepada qada' dan qadar Allah SWT yang mesti diiringi dengan usaha (Al-Makki 1997). Seperti doa Nabi Ibrahim as pada *Surah Ibrahim* ayat ke 37, baginda diperintahkan oleh Allah SWT untuk meninggalkan isteri dan anaknya di sebuah lembah yang kering dan tidak mempunyai tanam-tanaman di dalamnya. Baginda meletakkan pergantungan yang tinggi kepada Allah SWT pada ketika itu lalu berdoa agar keturunannya dapat memakmurkan tempat itu dengan melaksanakan ibadah kepada Allah SWT.

Reda

Surah Ibrahim (14: 38-39), *Surah As-Syu'ara'* (26: 87) & *Surah As-Saffat* (37: 100)

Maqam reda merupakan suatu kemuncak ganjaran daripada Allah SWT. Terdapat dua definisi reda menurut Al-Makki (1997) iaitu yang pertama, apabila seseorang hamba tidak membezakan antara pemberian dan tegahan daripada Allah SWT. Manakala definisi kedua ialah tidak berbolak-balik hatinya pada sesuatu yang ada mahupun yang tiada. Hal ini bertepatan dengan doa Nabi Ibrahim as pada ketika baginda berhijrah ke suatu tempat setelah ditentang oleh kaumnya sendiri lalu baginda memohon kepada Allah SWT agar dikurniakan zuriat untuknya dalam menyambung perjuangan dakwahnya. Menerusi doanya pada *maqam* ini, Allah SWT telah mengurniakan nikmat seorang zuriat yang mempunyai sifat sabar yang tinggi untuknya.

Mahabbah

Surah Al-Baqarah (2: 126), *Surah Al-Baqarah* (2: 127-128), *Surah Al-Baqarah* (2: 129), *Surah Ibrahim* (14: 35), *Surah Ibrahim* (14: 37), *Surah Ibrahim* (14: 38-39), *Surah Ibrahim* (14: 40-41), *Surah Al-Syu'ara'* (26: 83), *Surah Al-Syu'ara'* (26: 84), *Surah Al-Syu'ara'* (26: 85), *Surah Al-Syu'ara'* (26: 86), *Surah Al-Syu'ara'* (26: 87), *Surah As-Saffat* (37: 100), *Surah Al-Mumtahanah* (60: 4) & *Surah Al-Mumtahanah* (60: 5)

Definisi mahabbah adalah suatu perasaan cinta, kasih dan sayang kepada Allah SWT dengan cara memuliakan-Nya, mengagungkan-Nya serta malu kepada-Nya (Al-Makki 1997). Berdasarkan kepada semua doa yang dipohon oleh Nabi Ibrahim as di dalam Al-Quran, baginda dilihat telah menembusi *maqam mahabbah* dengan mengagungkan Allah SWT dalam setiap ujian yang ditempuhi. Baginda sentiasa mengingati Allah SWT dengan cara berdoa sama ada pada saat kesulitan mahupun tidak. Hal ini bertepatan dengan gelarannya sebagai *khalilullah* iaitu kekasih Allah SWT berdasarkan kepada perasaan kasih dan cintanya kepada Allah SWT yang sangat tinggi dan tidak dapat disangkal melalui kesemua doa-doanya yang telah diungkap di dalam Al-Quran.

KESIMPULAN

Secara kesimpulannya, psikospiritual Islam merupakan salah satu elemen penting yang ada di dalam diri manusia bagi menyempurnakan fizikal dan kehidupan yang sejahtera. Kepentingan psikospiritual ini dapat memberikan impak yang positif dalam kehidupan manusia jika memperolehi mental dan rohani yang sihat berasaskan kepada pendekatan ibadah doa dalam kehidupan seharian. Tambahan pula pendekatan yang diambil melalui doa daripada rasul yang mempunyai jiwa dan spiritual yang mulia, iaitu doa Nabi Ibrahim as yang terdapat di dalam kitab suci Al-Quran. Jika disorot kembali secara umum ketauhidan Nabi Ibrahim as, terdapat hubungkait antara doa Nabi Ibrahim as dalam Al-Quran dengan elemen psikospiritual yang

telah diketengahkan. Oleh itu, kajian mendapati bahawa setiap ayat Al-Quran yang berkaitan dengan doa Nabi Ibrahim as mempunyai hubungan dengan Kaedah Psikoterapi Iman, Kaedah Psikoterapi Ibadah dan Kaedah Psikoterapi Tasawwuf. Manakala Kaedah maqamat yang diaplikasikan dibawah Kaedah Psikoterapi Tasawwuf adalah berdasarkan kepada sembilan Maqamat antaranya ialah *maqam* taubat, *maqam* sabar, *maqam* syukur, *maqam* raja', *maqam* khauf, *maqam* zuhud, *maqam* tawakkal, *maqam* reda dan *maqam* mahabbah. Elemen ini juga diteliti melalui tafsiran ayat-ayat Al-Quran yang mempunyai hubungkait dengan pengukuhan psikospiritual.

RUJUKAN

- Al-Ghazali. Abu Hamid Muhammad Bin Muhammad Al-Ghazali, 2017. *Ringkasan Ihya' Ulumuddin*. Selangor: Pustaka Al-Ehsan.
- Al-Makki, Abu Talib. 1997. *Qut Al-Qulub*. Jilid 1. Beirut: Dar Al-Kitab Al-Ilmiyah.
- Che Zarrina Sa'ari. 2019. Psikospiritual Islam: Konsep dan Aplikasi. *Journal of Syarie Counseling* 1(1): 43-51.
- Dewan Bahasa dan Pustaka. 2015. *Kamus Dewan Edisi Keempat*. Kuala Lumpur: Dewan Bahasa dan Pustaka.
- Fakhr Al-Din Al-Razi. 1401H/1981. *Tafsir Al-Kabir Wa Mafatihul Ghaib*. Dar al-Fikr.
- Fariza Md Sham, Salasiah Hanim Hamjah & Mohd. Jurairi Sharifudin. 2017. *Personaliti Dari Perspektif Al-Ghazali*. Bangi: Universiti Kebangsaan Malaysia.
- Ibnu Katsir. 2005. *Lubaabut Tafsir Min Ibni Katsir*. Kairo: Mu-assasah Dar al-Hilal.
- Rahmat Firdaus. 2019. *Doa Nabi Ibrahim AS Dalam Al-Quran: Kajian Tafsir Tematik*. (Disertasi Sarjana, Universitas Islam Negeri Alauddin Makassar, Indonesia) 45.
- Mohd Abbas Abdul Razak, Maziah Bt Mustapha & Md Yousuf Ali. 2017. Human Nature and Motivation: A Comparative Analysis between Western and Islamic Psychologies. *Intellectual Discourse* 25.
- Muhd Afiq Abd Razak & Mohd Syukri Zainal Abidin. 2020. Psikospiritual Islam Menurut Perspektif Maqasid Al-Syariah: Satu Sorotan Awal. *Prosiding Seminar Antarabangsa Kaunseling Islam 2020*.
- Mohd Nasir bin Masroom & Wan Ismail Wan Dagang. 2013. Peranan Ibadah Terhadap Kesihatan Jiwa. *Seminar Falsafah Sains Dan Teknologi Fakulti Tamadun Islam UTM Johor Bahru, Malaysia, 2013*, hlm. 1-9.
- Mohd Shahril Othman. 2014. *Isu-Isu Kontemporari Dalam Islam Psikospiritual Islam*. Cetakan Pertama. Selangor: Univision Press SDN BHD.
- Najah Nadiah Amran & Haziyah Hussin. 2020. Wanita dan Pengurusan Emosi Melalui Pengkisahan Maryam dalam al-Quran. *International Journal Of Islamic Thought*. 17.
- Nazrin Asyraf Adeeb M & Rafidah Bahari. 2017. The Effectiveness Of Psycho-Spiritual Therapy Among Mentally III Patients. *Journal Of Depression And Anxiety*. 6(2).
- Norhafizah Musa, Azahar Yaakub @ Ariffin, Siti Suhaila Ihwani, Adibah Muhtar, Zaharah Mustafa, Mohd Hambali Rashid. 2018. Psikoterapi Islam Menurut Al-Quran Dan Al-Sunnah Dalam Mengurus Tekanan Pesakit Kanser Payudara. *Journal Of Social Sciences And Humanities*. 13(2).
- Norhafizah Musa & Che Zarrina Sa'ari. 2019. Pendekatan Psikoterapi Islam dalam Menguruskan Tekanan Pesakit Kronik. *Jurnal Usuluddin*. 47(1).
- Rosni Wazir, Abur Hamdi Usman, Syamim Zakwan Rosman, Suriani Sudi et al. 2020. Pencegahan Dadah Golongan Berisiko Menurut Pendekatan Psikospiritual Al-Ghazali. *Journal Al-Irsyad*. 5(2).
- Sapora Sipon & Ruhaya Hussin. 2019. *Teori Kaunseling Dan Psikoterapi*. Edisi 4. Negeri Sembilan: USIM.

- Sayyid Quthb. 2004. *Tafsir Fi Zhilalil Quran*. Jakarta: Gema Insani.
- Sharifah Basirah Syed Muhsin & Che Zarrina Sa'ari. 2015. *Kaedah Psikoterapi Islam: Berasaskan Konsep Maqamat Abu Talib Al-Makki*. Kuala Lumpur: Dewan Bahasa dan Pustaka.
- Sheikh Abdullah Basmeih. 2013. *Tafsir Pimpinan Ar-Rahman Kepada Pengertian Al-Quran* Kuala Lumpur: Darul Fikir SDN BHD.
- Siti Norlina Muhamad. 2018. *Psikoterapi Islam: Konsep, Kaedah dan Panduan*. Kuala Lumpur: Dewan Bahasa dan Pustaka.
- Wahbah Zuhaili. 2013. *Tafsir Al-Munir: Aqidah, Syari'ah & Manhaj*. Jakarta: Gema Insani.



Faktor Pendorong Kepada Minat Menyertai Badan Beruniform Bomba, PISPA Berbanding RELASIS di Politeknik Nilai

Norfazila Binti Ahmad
Politeknik Nilai Negeri Sembilan
norfazila672@gmail.com

ABSTRAK

Pendaftaran pelajar untuk badan beruniform di Politeknik Nilai, Negeri Sembilan menunjukkan bahawa BOMBA dan PISPA lebih ramai berbanding dengan Briged RELA Siswa Siswi (RELASIS). Data ini mendorong untuk menjalankan kajian untuk mengenal pasti punca berkaitan perkara ini. Oleh yang demikian, objektif kajian ini dijalankan adalah untuk menentukan faktor yang mendorong pelajar Politeknik Nilai Negeri Sembilan menyertai badan beruniform BOMBA dan PISPA berbanding Briged RELA Siswa Siswi (RELASIS). Kajian ini menggunakan kaedah kuantitatif untuk membentangkan analisis deskriptif kelebihan BOMBA dan RELASIS. Sampel kajian ini adalah seramai 102 orang pelajar Politeknik Nilai, Negeri Sembilan. Untuk mendapatkan data, instrumen soal selidik menggunakan teknik pensampelan rawak mudah. Data kajian telah dianalisis secara deskriptif untuk mendapatkan nilai min. Dapatan kajian menunjukkan bahawa majoriti pelajar mendapati banyak kelebihan menyertai BOMBA atau PISPA berbanding dengan RELASIS dalam aspek menyediakan pelajar supaya mempunyai sikap bertanggungjawab, banyak nilai-nilai murni diterapkan ke dalam jiwa pelajar dan menerapkan aspek untuk memperbaiki keyakinan diri. Hasil penyelidikan ini diharapkan dapat memberi gambaran kepada pihak pentadbir untuk menilai semula aktiviti RELASIS sehingga kurang mendapat sambutan dalam kalangan pelajar.

Kata Kunci: *Badan beruniform, BOMBA, PISPA, RELASIS*

PENGENALAN

Penglibatan pelajar dalam persatuan atau badan beruniform dan sebagainya di Institut Pengajian Tinggi adalah sangat penting bagi mengurangkan kes ponteng, menggalakkan kehadiran ke sekolah, memberi perhatian kepada pelajaran dan memupuk unsur disiplin, fokus dan tingkah laku yang baik. Di samping itu, ia mendorong pelajar kepada beberapa kemahiran seperti kemahiran pembentangan, membantu mereka bercakap dengan yakin dan memberikan rasa motivasi. Menurut Bokhari et al. (2015), melalui penglibatan dalam persatuan beruniform, ianya akan dapat membina kemahiran kepimpinan yang dapat ditunjukkan melalui aktiviti yang melibatkan hubungan kuasa dan keupayaan manusia untuk memberi arahan dalam mempengaruhi orang lain untuk melakukan sesuatu. Kemahiran kepimpinan boleh dikembangkan melalui pelbagai cara, kaedah, atau aktiviti. Secara khususnya, pelajar dapat mengembangkan kemahiran kepimpinan mereka dengan menyertai pelbagai aktiviti kokurikulum yang ditawarkan oleh institusi pembelajaran mereka.

Di Politeknik Nilai, pelajar telah diberi pilihan untuk mengikuti sama ada BOMBA, PISPA atau RELASIS. Pelajar biasanya akan memilih persatuan yang betul-betul dirasakan dapat memberi mereka kebaikan dan manfaat serta menyeronokkan semasa menjalankan sesi latihan. Namun begitu, senario semasa mendapati bahawa penglibatan pelajar lebih ramai menyertai BOMBA dan PISPA berbanding RELASIS. Keadaan ini membimbangkan kerana apabila penyertaan berkurangan, RELASIS kemungkinan tidak akan ditawarkan lagi pada sesi pembelajaran akan datang. Justeru menjadi persoalan apakah yang menyebabkan ramai pelajar menolak RELASIS berbanding dengan dua badan beruniform yang lain. Kajian perlu dijalankan untuk mengenal pasti punca bagi merangka semula penstrukturan kokurikulum dan

kesesuaiannya dalam kalangan pelajar Politeknik. Justeru itu, berdasarkan kepada senario yang berlaku, objektif kajian ini dijalankan adalah untuk menilai faktor yang mendorong pelajar Politeknik Nilai menyertai badan beruniform BOMBA dan PISPA berbanding RELASIS.

SOROTAN KAJIAN

Menurut Bokhari et al. (2015), penglibatan pelajar dalam persatuan atau badan beruniform dapat membentuk kemahiran insaniah setiap pelajar. Kemahiran insaniah ini penting bagi memastikan graduan seimbang dari segi pembangunan rohani, jasmani dan akhlak. Pandangan ini disokong oleh Saifullizam (2006) yang menyatakan bahawa pelajar boleh meraih banyak faedah dengan menyertai aktiviti kokurikulum termasuk mengelakkan pengaruh negatif terhadap kesejahteraan rohani, jasmani dan emosi mereka. Menurut Bunyawanich et al. (2018) telah dilihat mewakili idea-idea kesopanan, kehormatan, perpaduan, dan keunikan. Untuk badan beruniform BOMBA, program ini dikendalikan oleh Kementerian Pendidikan Malaysia sempena Perkhidmatan Bomba dan Penyelamat Malaysia. Pelajar yang terlibat dalam program ini menerima latihan asas memadam kebakaran, seperti berjalan dan teknik asas untuk menggunakan dan mengendalikan hos. Pelajar juga didedahkan dengan langkah-langkah keselamatan yang perlu diambil sekiranya berlaku musibah. Kepentingan latihan asas kebakaran telah didedahkan dalam banyak penyelidikan seperti Prashant dan Tharmarajan (2007); Setyawan dan Kartika (2008); dan Tahta (2018). Justeru itu tujuan pengenalan BOMBA dilihat oleh pelajar adalah selari dengan keperluan untuk menyelamatkan dalam situasi yang sebenar seperti ketika banjir (Agustina, 2013).

Sementara itu, bagi Pasukan Institusi Pertahanan Awam (PISPA), kajian yang dijalankan oleh Azizi et al. (2020) mendapati bahawa faktor dan kesan motivasi menyertai PISPA paling dominan ialah kerjaya dan peningkatan diri. Dapatan kajian tersebut telah membuktikan bahawa penyertaan pelajar dalam badan beruniform dapat membentuk semangat kesukarelawan dalam kalangan diri pelajar. Manakala, Menurut Yusak et al. (2019), RELASIS telah ditubuhkan di 25 buah Politeknik seluruh Malaysia memberikan impak positif kepada para pelajar terutamanya dalam aspek kemahiran generik dan kemahiran insaniah. Pemupukan semangat berpasukan dan kekitaan yang diterapkan dalam badan beruniform memberikan kesan positif kepada pembentukan sahsiah dan peribadi pelajar.

METODOLOGI

Kajian ini merupakan kajian kuantitatif yang dijalankan dalam bentuk tinjauan. Responden kajian ini adalah seramai 102 orang pelajar peringkat diploma Politeknik Nilai. Item kajian adalah seperti yang ditunjukkan dalam Jadual 1. Instrumen yang digunakan untuk mendapatkan data adalah menggunakan soal selidik yang diedarkan menggunakan *google form*. Data yang diperoleh akan dianalisis secara deskriptif untuk mendapatkan nilai skor min bagi pandangan pelajar. Nilai skor min akan diterjemah kepada nilai tahap seperti yang dicadangkan oleh Ngadiman et al. (2019) seperti berikut: 1.00– 1.99 (Lemah), 2.00– 2.99 (Rendah), 3.00– 3.99 (Sederhana) dan 4.00– 5.00 (Tinggi).

Jadual 1: Item Kajian

No. Item	Item Kajian
U1	Menyertai BOMBA atau PISPA atas memang minat sendiri dari awal
U2	Menyertai BOMBA atau PISPA atas nasihat orang lain (keluarga atau kawan-kawan)

- U3 Kagum dengan persembahan yang ditunjukkan oleh pasukan BOMBA atau PISPA.
 - U4 Suka dengan cara latihan badan beruniform BOMBA atau PISPA.
 - U5 Aspek kepimpinan lebih ditekankan dalam badan beruniform BOMBA dan PISPA.
 - U6 Aspek memupuk nilai integrasi kaum lebih ditekankan dalam badan beruniform BOMBA atau PISPA.
 - U7 Aspek disiplin lebih ditekankan dalam badan beruniform BOMBA dan PISPA
 - U8 Aspek hormat menghormati lebih diterapkan dalam badan beruniform BOMBA dan PISPA.
 - U9 Aktiviti badan beruniform BOMBA atau PISPA lebih aktif berbanding RELASIS.
 - U10 Banyak nilai-nilai murni diterapkan ke dalam jiwa pelajar apabila menyertai badan beruniform BOMBA atau PISPA.
 - U11 Menyertai badan beruniform BOMBA atau PISPA akan lebih meningkatkan semangat kerja berpasukan.
 - U12 Menyertai badan beruniform BOMBA atau PISPA akan lebih memantapkan ketahanan mental dan fizikal.
 - U13 Aspek semangat patriotik lebih ditekankan dalam badan beruniform BOMBA dan PISPA.
 - U14 Badan beruniform BOMBA atau PISPA lebih menyediakan pelajar supaya mempunyai sikap bertanggungjawab.
 - U15 Terdapat pengisian masa lapang/cuti apabila menganggotai badan beruniform BOMBA atau PISPA berbanding RELASIS.
 - U16 Badan beruniform BOMBA atau PISPA lebih mengutamakan perwatakan sahsiah
 - U17 Badan beruniform BOMBA atau PISPA lebih memupuk nilai kemasyarakatan di kalangan pelajar.
 - U18 Melalui kegiatan dan aktiviti kokurikulum badan beruniform BOMBA atau PISPA, akan membantu perkembangan dan kematangan sosial pelajar serta menyesuaikan diri dengan masyarakat sekeliling.
 - U19 Badan beruniform BOMBA atau PISPA lebih terdedah kepada pergaulan dan berinteraksi sesama rakan sebaya berbanding RELASIS.
 - U20 Menyertai unit beruniform BOMBA atau PISPA lebih menerapkan aspek untuk memperbaiki keyakinan diri.
-

KESIMPULAN

Penglibatan pelajar dalam acara kokurikulum khususnya badan beruniform akan meningkatkan efikasi sendiri, berkawan, mengembangkan pemahaman yang lebih baik tentang orang lain, menjadi lebih berorientasikan, dapat membuat keputusan yang matang, pemikiran kritis, meningkatkan perkembangan intelek, meningkatkan daya tahan dan dapat membangunkan kemahiran asas mengenai sesuatu aktiviti. Berdasarkan kepada hasil kajian yang dijalankan ini, pemilihan sesuatu aktiviti disebabkan oleh beberapa faktor utama. Walaupun begitu setiap

daripada badan brigid ini mempunyai kelebihan masing-masing yang hanya diperoleh apabila seseorang terlibat dengan brigid tersebut. Sebagai contoh, BOMBA lebih cenderung untuk memberi kesedaran tentang bahaya kebakaran dan langkah pencegahan; menghargai dan mengamalkan ilmu memadam kebakaran sebagai cara hidup; meningkatkan disiplin dan kesetiaan kepada rakan untuk memupuk semangat yakin diri dan tanggungjawab terhadap harta dan masyarakat. Manakala penubuhan PISPA adalah untuk menyebarkan dan mendidik pelajar tentang langkah-langkah keselamatan peribadi dan awam, serta membentuk watak mereka untuk menjadi pakar individu dalam sains perlindungan awam; menjadi pemangkin untuk meningkatkan kesedaran keselamatan awam melalui pengetahuan perlindungan awam yang diterapkan dan diterapkan di peringkat institusi pendidikan. Sementara itu misi penubuhan RELASIS adalah untuk mengekalkan dan menyokong keselamatan, keamanan, kemakmuran, keharmonian, perpaduan dan globalisasi.

HASIL KAJIAN

Latar Belakang Responden

Sampel kajian ini adalah terdiri daripada 102 orang pelajar Diploma Politeknik Nilai. Perincian mengenai latar belakang mereka adalah seperti yang ditunjukkan dalam Jadual 2.

Jadual 2: Latar Belakang Demografi Responden

ITEM		<i>n</i>	%
Jantina	Lelaki	27	26.5
	Perempuan	75	73.5
HPNM	1.00 ke bawah	4	3.9
	2.00 – 2.99	11	10.8
	3.00 – 3.49	38	37.3
	3.50 – 3.67	20	19.6
	3.68 – 4.00	29	28.4
	Pernah mengikuti badan beruniform semasa sekolah menengah	Tidak	5
Ya		97	95.1
Ada ahli keluarga yang pernah mengikuti badan beruniform Brigid Bomba atau PISPA	Tidak	66	64.7
	Tidak pasti	22	21.6
	Ya	14	13.7
Pernah mengikuti perkembangan badan beruniform brigid Bomba atau PISPA	Tidak	83	81.4
	Ya	19	18.6
Mengikuti perkembangan badan beruniform Brigid Bomba atau PISPA di Media Sosial seperti facebook/Instagram atau lain-lain	Tidak	83	81.4
	Ya	19	18.6
Pernah kagum dengan salah seorang ahli Bomba atau PISPA	Tidak	65	63.7
	Ya	37	36.3
Mencadangkan supaya pelajar mengikuti badan beruniform Brigid Bomba atau PISPA berbanding RELASIS	Tidak	9	8.8
	Tidak pasti	33	32.4
	Ya	60	58.8

Analisis Hasil Kajian

Jadual 3 menunjukkan faktor-faktor yang mendorong kepada penyertaan badan beruniform Bomba atau PISPA berbanding RELASIS dalam kalangan pelajar Politeknik Nilai. Tiga faktor utama yang memperoleh min tertinggi adalah (U14) iaitu Badan Beruniform Brigid Bomba

atau PISPA lebih menyediakan pelajar supaya mempunyai sikap bertanggungjawab; diikuti oleh (U10) iaitu banyak nilai-nilai murni diterapkan ke dalam jiwa pelajar apabila menyertai badan beruniform Briged Bomba atau PISPA; dan (U20) iaitu Menyertai unit beruniform Briged Bomba atau PISPA lebih menerapkan aspek untuk memperbaiki keyakinan diri.

Jadual 3: Faktor pendorong kepada penyertaan badan beruniform Bomba atau PISPA berbanding RELASIS

Tahap Persetujuan (Dalam %)								
ITEM	STS	TS	N	S	SS	SP	MIN	TAHAP
U14	4.9	6.9	20.6	34.3	33.3	1.11	3.84	Sederhana
U10	3.9	7.8	19.6	38.2	30.4	1.07	3.83	Sederhana
U20	5.9	8.8	16.7	33.3	35.3	1.18	3.83	Sederhana
U12	5.9	6.9	19.6	34.3	33.3	1.15	3.82	Sederhana
U11	5.9	8.8	17.6	33.3	34.3	1.18	3.81	Sederhana
U7	3.9	9.8	22.5	31.4	32.4	1.12	3.78	Sederhana
U8	5.9	5.9	22.5	37.3	28.4	1.11	3.76	Sederhana
U13	3.9	8.8	23.5	35.3	28.4	1.08	3.75	Sederhana
U17	5.9	5.9	23.5	37.3	27.5	1.11	3.75	Sederhana
U18	5.9	6.9	19.6	42.2	25.5	1.10	3.75	Sederhana
U5	5.9	10.8	19.6	35.3	28.4	1.17	3.70	Sederhana
U16	5.9	6.9	24.5	41.2	21.6	1.08	3.66	Sederhana
U6	4.9	8.8	28.4	35.3	22.5	1.08	3.62	Sederhana
U3	7.8	7.8	25.5	36.3	22.5	1.16	3.58	Sederhana
U19	7.8	8.8	29.4	32.4	21.6	1.16	3.51	Sederhana
U4	7.8	12.7	24.5	31.4	23.5	1.21	3.50	Sederhana
U9	4.9	9.8	43.1	24.5	17.6	1.05	3.40	Sederhana
U15	7.8	12.7	40.2	27.5	11.8	1.07	3.23	Sederhana
U1	9.8	23.5	29.4	23.5	13.7	1.19	3.08	Sederhana
U2	19.6	25.5	36.3	16.7	2.0	1.05	2.56	Rendah

Nota : U14,U10 Dan U20 Adalah Tiga Faktor Tertinggi Mengikut Skor Min Tertinggi

RUJUKAN

- Agustina, R. F. (2013). *Hubungan komitmen, pengetahuan dan sistem operasi dengan kesiapsiagaan menghadapi bencana banjir: satu kajian kes di Pejabat Daerah Kubang Pasu* (Doctoral dissertation, Universiti Utara Malaysia).
- Angkatan Pertahanan Awam Malaysia. Pasukan Institusi Pertahanan Awam (PISPA). <https://www.civildefence.gov.my/perkhidmatan/pasukan-institusi-pertahanan-awam-pispa/>
- Bokhari, N., Razali, A., Yusof, F. M., & Zakaria, N. (2015). Role of uniform bodies in inculcating leadership skills. *Procedia-Social and Behavioral Sciences*, 204, 343-351.
- Bunyanich, S., Järvelä, M. L., & Ghaffar, A. (2018). The Influence of Uniform in Establishing Unity, Hierarchy, and Conformity at Thai Universities. *Journal of Education and Training Studies*, 6(7), 28-37.
- Ngadiman, D. W. T., Yacoob, S. E., & Wahid, H. (2019). Tahap Harga Diri Kumpulan Berpendapatan Rendah yang Berhutang dan Peranan Organisasi dalam Sektor Perladangan. *Melayu: Jurnal Antarabangsa Dunia Melayu*, 12 (2), 238-254.
- Prashant, T., & Tharmarajan, L. (2007). The essential aspect of fire safety management in high rise buildings. *Faculty of Civil*.

- Saifullizam, P. (2006). "Modul Pengurusan Kokurikulum." 1st ed. Fakulti Pendidikan Teknikal :UTHM
- Setyawan, A., & Kartika, E. W. (2008). Studi eksploratif tingkat kesadaran penghuni gedung bertingkat terhadap bahaya kebakaran: studi kasus di universitas kristen petra surabaya. *Jurnal Manajemen Perhotelan*, 4 (1), 28-38.
- Tahta, a. D. (2018). *Penilaian keselamatan latihan kebakaran pada kapal penumpang km. Niki sae* (Doctoral dissertation, Politeknik Ilmu Pelayaran Semarang).



Pengaruh Media Massa dan Keperluan ICT dalam Pengurusan Aktiviti Nelayan di Malaysia

Mohd Rushdi Idrus
Universiti Utara Malaysia
rushdi@uum.edu.my

Malike Brahim
Universiti Utara Malaysia
malike@uum.edu.my

Yusuf Pon
Universiti Utara Malaysia
p.yusuf@uum.edu.my

ABSTRACT

Mass media and social media have an important influence on the lives and activities of the fishing community in Malaysia today. The use of smartphones and social media is becoming more widespread when there are internet and WiFi facilities. Smartphones are now the most important communication tool for fishermen. It is also the most important source of information on government policies and programs. In addition, fishermen are already exposed to social media such as WhatsApp and Facebook as communication tools. The findings of the study show that the mass media and social media have a significant influence in helping the fishing community communicate and search for information. Therefore, to balance the implementation of policies and programmes and to manage various fishing activities by the Malaysian Fisheries Development Authority (LKIM), it is time for the transformation by using ICT to be implemented to improve the quality of services, increasing the effectiveness and efficiency of policy implementation, information distribution, detection of fishermen's identity, and so on. Some actions that can be considered towards the goal are the usage of RFID sensors and QR Codes. The use of RFID sensors and QR Codes can be integrated into the Fishing Boat Subsidy Information System with the aim to improve control over subsidies related to subsistence allowances, fish catch incentives, and diesel and petrol subsidy schemes, including SOPs on the part of LKIM in the distribution of assistance and subsidies to related fishing groups.

Keywords: *assistance, fishermen; ICT; mass media; social media.*

ABSTRAK

Media massa dan media sosial mempunyai pengaruh penting dalam kehidupan dan aktiviti masyarakat nelayan di Malaysia dewasa ini. Penggunaan telefon pintar dan media sosial semakin meluas apabila ada kemudahan Internet dan WiFi. Telefon pintar kini merupakan alat komunikasi terpenting kepada nelayan. Ia juga menjadi sumber carian maklumat terpenting tentang dasar dan program kerajaan. Selain itu, nelayan sudah terdedah dengan media sosial seperti WhatsApp dan Facebook sebagai alat untuk berkomunikasi. Dapatan kajian menunjukkan media massa dan media sosial mempunyai pengaruh yang besar untuk membantu masyarakat nelayan berkomunikasi dan pencarian maklumat. Justeru, bagi mengimbangi pelaksanaan dasar dan program serta menguruskan pelbagai aktiviti nelayan oleh Lembaga Kemajuan Ikan Malaysia (LKIM), maka sudah tiba masanya suatu transformasi perlu dilakukan bagi memperbaiki kualiti perkhidmatan, meningkatkan keberkesanan dan kecekapan pelaksanaan dasar, penyaluran maklumat, pengesanan identiti nelayan dan sebagainya melalui transformasi ICT. Beberapa tindakan yang boleh dipertimbang ke arah

tujuan tersebut seperti penggunaan sensor RFID dan QR Code. Penggunaan sensor RFID dan QR Code boleh diintegrasikan kepada Sistem Maklumat Subsidi Bot Nelayan bertujuan menambah baik kawalan terhadap subsidi berkaitan elaun sara hidup, insentif hasil tangkapan ikan dan skim subsidi diesel dan petrol termasuklah SOP di pihak LKIM dalam penyaluran bantuan dan subsidi kepada kumpulan nelayan yang berkaitan.

Kata Kunci: bantuan; ICT; media massa; media sosial; nelayan.

PENGENALAN

Nelayan adalah suatu kumpulan masyarakat yang kehidupan mereka bergantung secara langsung kepada hasil laut sama ada melalui aktiviti penangkapan ikan atau lain-lain proses berkaitan dengan pengeluaran pelbagai produk berasaskan ikan. Pada umumnya, kumpulan ini tinggal di kawasan pinggir atau pesisir pantai yang lazimnya bermukim dalam lingkungan yang berdekatan dengan lokasi kegiatannya. Jadi, rutin harian mereka berkisar dalam ruang atau zon dengan aktiviti yang hampir sama.

Kehidupan nelayan sinonim dengan kemiskinan dan kumpulan yang berpendapatan rendah. Justeru, nelayan merupakan kumpulan dalam masyarakat yang banyak menerima bantuan dan subsidi daripada kerajaan. Disebabkan kemiskinan, menurut Muhammad Rafi, Sharifah Rohayah dan Sofia Haminah (2019), komuniti nelayan mempunyai lima cabaran hidup iaitu kesukaran menampung perbelanjaan harian; kesukaran melanjutkan pendidikan; kesukaran memiliki aset; keperluan melakukan pekerjaan sampingan; dan ancaman gejala sosial.

Walaupun masyarakat nelayan antara komuniti minoriti yang wujud di Malaysia, tetapi mereka mempunyai peranan yang signifikan dalam ekonomi negara. Sumbangan utama nelayan dari segi sumber laut untuk masyarakat, di mana ia dipercayai mampu menjana pendapatan yang besar kepada pihak yang terlibat dalam industri perikanan di Malaysia. Dalam hal ini, Hayrol Azril, *et. al.* (2011) menjelaskan bahawa sumbangan nelayan ke atas ekonomi tidak dapat disangkal, di mana rakyat di negara ini bergantung kepada nelayan untuk mendapatkan sumber protein berasaskan sumber laut.

Realitinya, nelayan bukanlah entiti tunggal. Mereka terdiri daripada beberapa kelompok yang berada dalam masyarakat nelayan itu sendiri. Menurut Dewan Bahasa dan Pustaka (Edisi Keempat), nelayan adalah penangkap ikan di laut dan di sepanjang perairan dekat pantai menggunakan bot dan peralatan tertentu. Pengertian ini menepati penjelasan dalam Seksyen 2 (Bahagian 1) Akta Perikanan 1985 (Akta 317) bahawa nelayan itu merupakan orang yang berusaha dan mencuba menangkap ikan, mengambil, membunuh ikan dengan apa juga cara (Malaysia, 1985). Pada asasnya, ada tiga kelompok yang berbeza dari segi pemilikan alat tangkap asas seperti bot atau kapal dan pukut iaitu (i) nelayan buruh (awak-awak); (ii) nelayan perseorangan (pemilik bot); dan (iii) nelayan jurugan (pengusaha bot).

Dalam beberapa siri Rancangan Lima Tahun Malaysia pun nasib masyarakat nelayan sentiasa diberi perhatian oleh pihak kerajaan. Oleh itu, tanggungjawab bagi menyampaikan perkhidmatan terbaik masyarakat nelayan adalah menerusi Kementerian Pertanian dan Industri Makanan (MAFI) bersama agensi utamanya seperti Jabatan Perikanan Malaysia (DOFM) dan Lembaga Kemajuan Ikan Malaysia (LKIM) di seluruh negara dengan kerjasama Persatuan Nelayan Kawasan (PNK) masing-masing.

Evolusi Teknologi Maklumat dan Komunikasi (ICT) merangkumi komputer atau peranti yang merupakan komponen penting ICT melalui satu revolusi komputer yang ketara. Revolusi tersebut merangkumi saiz memori, kelajuan, fungsi, perkakasan, perisian dan aspek lain yang menyumbang kepada komputer yang canggih hari ini (Holmes 2005). Aplikasi Teknologi Maklumat dan Komunikasi (ICT) juga bertukar mengikut keperluan pengguna. Pengguna mahukan perisian, perkakasan dan kemahiran komputer yang sepadan dengan keperluan makmal komputer mereka dan saiz peranti yang berkuasa menjadi semakin kecil dan mampu dibawa ke mana sahaja dalam bentuk komputer peribadi, tablet dan telefon pintar.

[Pengenalan Frekuensi Radio](#) (RFID) ialah sejenis teknologi tanpa wayar yang mengintegrasikan penggunaan gelombang radio untuk membaca data yang tertanam di dalamnya. Teknologi tanpa wayar ini pertama kali dicipta pada tahun 1948 oleh *Charles Warton* pada tahun 1970-an. Kelebihan RFID ialah pengkalan datanya lebih selamat kerana ia diekripsi dalam pelayan komputer dan pelbagai peranti mudah alih. Kini teknologi untuk pengurusan inventori, pengesanan bagasi dan pembayaran tidak memerlukan lagi sentuhan jarak dekat bagi berfungsi. Kod QR atau [Kod Respons Pantas](#) adalah jenis kod bar dua dimensi yang dicipta pada tahun 1994 oleh syarikat *Denso Wave*. kod QR mengimbas lebih pantas daripada kod bar satu dimensi biasa. Kod QR ini kini digunakan secara meluas dalam sektor perniagaan, penjagaan kesihatan, pengangkutan dan pendidikan. Memandangkan mereka berada di mana-mana, kod QR ini diletakkan di [poster](#), [risalah](#), [risalah](#), [majalah](#), [tetingkap tingkap](#), [surat khabar](#), [pelabelan produk](#), [kad perniagaan](#), dan juga dalam [media sosial](#) siaran. Kelebihan kod QR ialah ia senang dihasilkan, murah, tidak mudah dimusnahkan serta boleh di semak menggunakan peranti mudah alih oleh sesiapa sahaja yang memiliki telefon pintar. Ia menjadi satu *Fin Tech* dan asalah normal melihat masyarakat membuat pembayaran menggunakan telefon pintar dan membuat transaksi dalam talian dengan selamat di Malaysia.

Ismail, F. N., & Mokhtar, A. (2021) melaporkan hasil kajian mereka mendapati bahawa jangkaan keselamatan, nilai harga, pengaruh sosial, memudahkan keadaan, jangkaan usaha, jangkaan prestasi, motivasi hedonik dan niat tingkah laku memberi kesan yang signifikan terhadap kesediaan pengguna telefon pintar untuk menggunakan pembayaran mudah alih kod QR dalam urusan niaga pembayaran di Malaysia ini dapat menjadi satu strategi pemasaran syarikat dan perniagaan bagaimana menarik pelanggan untuk berbelanja di kedai mereka.

Rushdi M N & Lee Z K (2022) merumuskan kod QR dan sensor RFID dapat diintegrasikan ke dalam kehidupan harian semua masyarakat kerana kosnya yang rendah dan perisian serta sensor seperti telah sedia terbin dalam semua telefon pintar yang digunakan dan selamat dan mudah digunakan oleh semua orang melalui isyarat internet atau wi fi.

Menurut Nadia Fauzi (2017) Internet dan capaian Wi Fi merupakan salah satu daripada keperluan harian dalam kehidupan setiap individu. Akses internet yang mudah didapati di mana-mana di samping penggunaan telefon pintar membuatkan masyarakat kini sentiasa mendapat maklumat atau berita-berita semasa hanya di hujung jari. Tidak dinafikan, kemudahan akses internet ini juga membuka peluang kepada penggunaan media sosial yang meluas di kalangan pengguna internet melalui peranti seperti komputer riba, tablet dan telefon pintar. Media sosial telah mendapat perhatian setiap peringkat umur masyarakat seiring dengan perkembangan teknologi yang semakin maju. Golongan remaja khususnya melihat media sosial sebagai satu trend terkini untuk mengisi aktiviti pada waktu lapang di samping bersosial di alam maya. Harian Metro turut melaporkan bahawa Malaysia muncul sebagai negara ketiga tertinggi untuk penggunaan internet, selepas Singapura dan Brunei daripada jumlah keseluruhan pengguna Internet di seluruh Asia Tenggara. Laporan ini jelas menunjukkan tahap

penggunaan internet yang tinggi dalam kalangan rakyat Malaysia. Penggunaan media sosial yang meluas dapat memberikan manfaat dan pada masa yang sama ia juga memberikan kesan yang buruk kepada masyarakat. Menurut Pengarah Institut Kajian Etnik (KITA), Universiti Kebangsaan Malaysia (UKM), Profesor Ulung Datuk Dr Shamsul Amri Baharuddin, walaupun media sosial telah menjadi alat yang berkesan untuk berkongsi maklumat, ia juga telah disalahgunakan oleh sesetengah pengguna sebagai alat untuk menyebarkan fitnah dan maklumat-maklumat yang salah dan tidak tepat.

Menurut laporan The Edge Market (2017), 71% orang dewasa di Malaysia memiliki sekurang-kurangnya satu telefon pintar. Ini menunjukkan bahawa kadar penembusan teknologi telefon pintar agak tinggi di Malaysia. Statistik mengenai jumlah pengguna internet di Malaysia juga menunjukkan bahawa jumlah pengguna di Malaysia telah meningkat kepada 25.08 juta, merangkumi 79% penduduk Malaysia

Tidak dapat dinafikan bahawa masyarakat masa kini lebih cenderung untuk menggunakan media sosial bagi membincangkan isu-isu terkini selain mengutarakan pendapat masing-masing berkenaan dengan isu-isu tersebut. Platform yang popular pada masa kini seperti Facebook, Twitter, Whatsapp, Instagram dan lain-lain merupakan medium utama media sosial yang sering digunakan oleh masyarakat. Ini ditambah pula dengan teknologi moden dan penggunaan telefon pintar yang memudahkan masyarakat untuk memperoleh dan berkongsi maklumat dalam masa yang singkat dan pantas. Bukan sahaja orang dewasa, malahan kanak-kanak dan remaja juga turut ghairah menjadikan media sosial sebagai sebahagian daripada keperluan hidup seharian. Jadi, tidak hairanlah jika dilihat di mana-mana tempat awam, pengangkutan awam mahupun di dalam kenderaan, seseorang itu akan lebih cenderung untuk melayari internet melalui telefon pintar masing-masing bagi mengisi kekosongan waktu mereka.

Masyarakat nelayan lazimnya menggunakan telefon pintar untuk mendapatkan maklumat seperti berita semasa dan hebahan kerajaan, mendapatkan hiburan, menjual produk atau servis berkaitan nelayan, melayari media sosial dan memohon bantuan keperluan semasa mereka.

KAEDAH KAJIAN

Perbincangan bagi topik kertas kerja ini adalah merujuk kepada “Kajian Impak Keberkesanan Dasar dan Program Bantuan Kerajaan kepada Masyarakat Nelayan di Malaysia” (dirujuk sebagai Kajian Impak Keberkesanan), satu projek perundingan antara pasukan penyelidik dari Universiti Utara Malaysia (UUM) dengan Lembaga Kemajuan Ikan Malaysia (LKIM). Secara umumnya, kajian ini melibatkan kesemua 89 Persatuan Nelayan Kawasan (PNK) di seluruh negara dengan jumlah responden melebihi 7,000 orang. Kerja lapangan bagi pengumpulan data telah dijalankan dalam tempoh dua bulan bermula 01 Disember 2021 hingga 31 Januari 2022.

Bagi kajian impak keberkesanan dasar dan program bantuan kerajaan kepada masyarakat nelayan di Malaysia adalah berupa kajian tinjauan yang menggunakan soal selidik untuk mendapatkan maklum balas daripada responden. Namun, di peringkat awal kajian ini, sumber-sumber sekunder seperti buku, artikel jurnal, laporan penyelidikan, tesis, dokumen rasmi kerajaan dan akhbar-akhbar tempatan telah diteliti bagi mendapat pelbagai maklumat.

Secara umumnya kajian ini dijalankan bertujuan menilai keberkesanan impak dasar dan program kerajaan kepada masyarakat nelayan di Malaysia khususnya sewaktu negara berada dalam PKP 1.0.

Objektif khusus bagi kajian ini adalah seperti berikut:

- a) Mengenal pasti kecenderungan sokongan nelayan terhadap kerajaan mengikut kriteria hitam, kelabu atau putih;
- b) Mengkaji faktor dominan mempengaruhi sokongan masyarakat nelayan kepada kerajaan;
- c) Menganalisis impak pemberian bantuan kerajaan terhadap kecenderungan sokongan nelayan kepada kerajaan
- d) Mengemukakan cadangan kepada kerajaan ke arah meningkatkan sokongan masyarakat nelayan menjelang PRU-15.

Proses pengumpulan data bagi kajian ini melibatkan pengumpulan data sekunder dan data primer. Bagi data sekunder, ia melibatkan penggunaan dan penelitian bahan atau sumber sekunder yang sedia ada dalam bentuk buku, artikel jurnal, laporan penyelidikan, tesis, prosiding seminar, kertas kerja seminar, laporan rasmi kerajaan seperti Laporan Tahunan LKIM, majalah, akhbar dan lain-lain yang telah didokumentasikan sama ada dalam bentuk bercetak atau elektronik.

Pengumpulan data primer pula menggunakan borang soal selidik atas talian (Google Form), di mana pautan (link) dikongsikan kepada pembanci untuk diedarkan kepada responden yang telah dipilih. Namun, borang bercetak juga digunakan sebagai alternatif bagi nelayan yang tiada kemudahan telefon pintar dan Internet. Dalam hal ini, data primer merupakan data yang dikumpulkan sendiri oleh penyelidik menggunakan Google Form, di mana sampelnya adalah nelayan yang menerima elaun sara hidup daripada kerajaan.

Pengaruh Media Massa

Jadual 1 di bawah memaparkan kekerapan dan nilai min bagi pembolehubah pengaruh media massa yang merupakan antara pembolehubah bebas dalam kajian ini. Terdapat 10 atribut yang mengukur pembolehubah pengaruh media massa, di mana nilai kekerapan yang ditunjukkan adalah mewakili tiga respon (tidak setuju, tidak pasti dan setuju) yang diberikan oleh responden terhadap pernyataan yang dikemukakan dalam soal selidik. Analisis dapatan kajian menunjukkan responden bersetuju bahawa telefon pintar merupakan sumber carian maklumat terpenting berkenaan dasar dan program kerajaan, iaitu sebanyak 67.5%, diikuti media sosial seperti WhatsApp dan Facebook (64.4%) dan radio, TV dan surat khabar (62.8%). Namun, 40.2% sahaja responden yang bersetuju dari segi kesahihan dan kebenaran maklumat berkaitan kerajaan yang diperoleh daripada media sosial.

Jadual 1: Pengaruh Media Massa

Pengaruh Media Massa (Min = 2.7332) n = 7146	Penilaian						Min
	Tidak Setuju		Tidak Pasti		Bersetuju		
	K	%	K	%	K	%	
1. Telefon pintar merupakan sumber carian maklumat terpenting berkenaan dasar dan program kerajaan.	31	.4	461	6.5	4824	67.5	2.90

2. Kemudahan capaian Internet yang disediakan di kawasan saya adalah memuaskan.	662	9.3	1081	15.1	3573	50.0	2.55
3. Media sosial seperti WhatsApp dan Facebook sangat berguna kepada saya untuk mengetahui maklumat tentang dasar dan program kerajaan.	49	.7	665	9.3	4602	64.4	2.86
4. Semua maklumat kerajaan yang diperolehi daripada media sosial tentang kerajaan adalah sah dan benar.	398	5.6	2045	28.6	2873	40.2	2.47
5. Maklumat utama berkaitan dasar-dasar kerajaan kepada masyarakat nelayan kerap disalurkan melalui media sosial.	98	1.4	1132	15.8	4086	57.2	2.75
6. Media sosial banyak mempengaruhi pemikiran nelayan untuk menyokong kerajaan.	176	2.5	1298	18.2	3842	53.8	2.69
7. Rakyat termasuk masyarakat nelayan adalah bebas untuk bersuara dan memberi pandangan melalui media sosial.	113	1.6	887	12.4	4316	60.4	2.79
8. Radio, TV dan surat khabar masih lagi menjadi sumber utama kepada kerajaan untuk menyalurkan maklumat kepada masyarakat nelayan.	95	1.3	734	10.3	4487	62.8	2.83
9. Generasi muda dalam masyarakat nelayan mudah terpengaruh dengan maklumat yang disampaikan oleh kerajaan melalui media sosial.	109	1.5	1019	14.3	4188	58.6	2.77
10. Kumpulan anti kerajaan banyak menggunakan media sosial untuk mempengaruhi masyarakat nelayan supaya tidak menyokong kerajaan.	223	3.1	1313	18.4	3780	52.9	2.67

Nilai min yang ditunjukkan dalam Jadual 1 di atas merupakan nilai min bagi setiap atribut yang mengukur pembolehubah pengaruh media massa. Bagi pembolehubah pengaruh

media massa, 10 atribut menunjukkan nilai min adalah antara 2.47 hingga 2.90. Nilai min ini menerangkan bahawa 10 atribut pengaruh media massa ini berada pada tahap tinggi. Antara 10 atribut pengaruh media massa ini, atribut yang pertama iaitu telefon pintar merupakan sumber carian maklumat terpenting berkenaan dasar dan program kerajaan merupakan attribut yang memberikan nilai min yang paling tinggi iaitu 2.90. Pernyataan ini disokong lagi apabila majoriti iaitu sebanyak 74% daripada 7,146 responden menggunakan telefon pintar.

Atribut ketiga iaitu pengaruh media sosial seperti WhatsApp dan Facebook yang berguna sebagai satu platform bagi mengetahui maklumat tentang dasar dan program kerajaan yang menunjukkan nilai min kedua tertinggi dengan nilai min 2.86. Manakala nilai min ketiga tertinggi diwakili oleh atribut kelapan iaitu radio, TV dan surat khabar masih lagi menjadi sumber utama kepada kerajaan untuk menyalurkan maklumat kepada masyarakat nelayan dengan nilai min 2.83. Nilai min yang dicatatkan paling rendah adalah bagi atribut keempat, bersamaan 2.47.

Jadi, secara umumnya responden bersetuju bahawa media massa mempunyai pengaruh yang besar dalam membantu masyarakat nelayan sebagai satu platform komunikasi dan pencarian maklumat berkaitan kerajaan. Jadual 2 di bawah menunjukkan tujuan masyarakat nelayan menggunakan telefon pintar. Data yang diperolehi mengikut tiga bacaan yang tertinggi termasuklah yang pertama sebagai medium untuk berkomunikasi (berhubung dengan orang lain), yang kedua bertujuan melayari media sosial seperti Facebook, WhatsApp dan Internet. Tujuan ketiga adalah untuk mencari maklumat merangkumi berita, politik dan ekonomi. Maklumat tambahan seperti yang ditunjukkan dalam Jadual 2 di bawah.

Jadual 2: Tujuan Penggunaan Telefon Pintar

Tujuan Penggunaan (n=5317)	Jumlah	
	Kekerapan	Peratusan
Berkomunikasi (berhubung dengan orang lain)	5177	97.4
Melayari media sosial (Facebook, WhatsApp, Internet)	4196	78.9
Mencari maklumat (berita, politik, ekonomi)	3990	75.0
Merakam gambar dan video	2337	44.0
Mendapatkan hiburan (lagu, video, movie)	2162	40.7
Urusan jual beli atas talian	1444	27.2
Permainan video (games)	1027	19.3
Pembelajaran (kuliah, PdPR)	722	14.5

Dapatan kajian ini turut menunjukkan masyarakat nelayan kini sangat terdedah dengan maklumat dan isu semasa kerana majoriti mereka memiliki telefon pintar dan ada kemudahan Internet atau WiFi. Jadi, melalui kemudahan ini, mereka mudah menerima dan menyampaikan sebarang maklumat termasuklah maklumat berkaitan bantuan kerajaan. Apatah lagi dewasa ini apabila segala maklumat boleh dikongsi dan diperolehi melalui media sosial termasuk pelbagai program dan dasar oleh MAFI dan LKIM khususnya melalui PNK masing-masing.

Dengan kata lain, penggunaan telefon pintar dan Internet kini sudah menjadi keperluan dalam masyarakat nelayan. Jadi, mereka boleh berkongsi maklumat berkaitan aktiviti dan rutin kehidupan dengan banyak pihak. Atas sebab itu, daripada maklum balas yang diterima menunjukkan responden sangat berharap kerajaan dapat menyediakan kemudahan dan menaik taraf liputan Internet di kawasan mereka terutama bagi keperluan pembelajaran dan pengajaran di rumah (PdPR) sewaktu tempoh PKP. Apatah lagi ada kawasan yang tiada sebarang kemudahan Internet dan liputannya sangat terhad hingga menyulitkan nelayan untuk mendapatkan maklumat. Dalam hal ini, kerajaan mesti bijak dan sentiasa peka kepada perkembangan media massa dalam proses berkomunikasi dengan kumpulan masyarakat seperti

nelayan. Apabila komunikasi dua hala boleh berlaku secara berkesan antara kerajaan dengan masyarakat nelayan, ia dapat membina hubungan dan interaksi yang baik antara kedua-dua pihak.

Cadangan Penambaihan

Masyarakat nelayan seharusnya sudah mula aktif melibatkan diri dalam dunia perniagaan secara elektronik (dalam talian). Ini bertepatan dengan pelancaran MyDigital dan Rangka Tindakan (Blueprint) Ekonomi Digital Malaysia pada 19 Februari 2021 oleh mantan Perdana Menteri Tan Sri Muhyiddin Yassin. MyDigital bertujuan mengukuhkan sektor perniagaan terutamanya perniagaan kecil dan sederhana dengan transformasi digital supaya mampu bersaing di peringkat global serta meningkatkan kehidupan rakyat melalui ekonomi digital. Beberapa insentif disediakan oleh MyDigital melalui pengenalan teknologi digital seperti kemudahan membeli tanpa tunai (membuat pembayaran menggunakan Touch n Go, e-wallet, GrabPay dan Boost). Ini semua merupakan teknologi e-Wallet yang menarik pengguna untuk menyertai portal e-Dagang.

Astro Awani pada 7 September 2022 melaporkan hasil kajian oleh syarikat penyelidikan dan perundingan pasaran antarabangsa, Ipsos Malaysia melibatkan lebih 1,000 responden berkongsi pendapat dan pengalaman mereka menggunakan platform e-Dagang sepanjang pembukaan semula ekonomi dalam enam bulan terkini pada April 2022 yang mengambil kira faktor Malaysia kini telah berada kepada fasa peralihan pandemik ke endemik. Dapatan kajian menunjukkan sedikit penurunan aktiviti melayari platform e-Dagang daripada 75 peratus kepada 72 peratus. Namun, peningkatan sebanyak 1 peratus pembelian melalui platform e-Dagang dalam enam bulan terkini direkodkan. Walaupun sektor ekonomi sudah dibuka dan operasi perniagaan secara fizikal sudah dibenarkan, tetapi dapatan kajian tersebut menunjukkan bahawa rakyat Malaysia sudah selesa dengan kaedah pembelian secara elektronik khususnya ketika pelaksanaan PKP.

Oleh sebab itu, pendapatan menerusi e-Dagang telah meningkat 7.7 peratus pada suku kedua tahun 2022 membabitkan nilai RM288.2 bilion berbanding tempoh yang sama pada tahun 2021 yang hanya RM267.2 bilion. Terdapat pelbagai jenis platform e-Dagang di pasaran dan Shopee menjadi pilihan tertinggi sebanyak 79 peratus, diikuti Lazada (21 peratus) dan Facebook (18 peratus) serta Trivago (0.5%). Jadi, dicadangkan supaya usahawan nelayan menggunakan platform e-Dagang sebagai strategi untuk meningkatkan ekonomi selaras dengan trend semasa di Malaysia.

Dengan adanya kemudahan Internet, telefon pintar dan pelancaran MyDigital, dikemukakan beberapa cadangan seperti berikut. Memandangkan majoriti masyarakat nelayan menggunakan telefon pintar sewajarnya pihak LKIM mengambil peluang menyampaikan maklumat penting menerusi medium dalam talian dan medium media sosial yang berkaitan. Selain itu, dicadangkan LKIM untuk mengaplikasikan penggunaan aplikasi tertentu bagi memudahkan proses kerja seperti permohonan, pendaftaran, pendaftaran semula, dan lain-lain proses kerja yang berkaitan. Bagi nelayan yang belum memiliki telefon pintar adalah dicadangkan LKIM sendiri memeterai MOU dengan penyedia telekomunikasi seperti DiGi, Celcom dan sebagainya dengan memberikan pakej tertentu kepada mereka melalui bayaran ansuran setiap bulan. Ini membuka peluang kepada masyarakat nelayan untuk menggunakan media sosial dan platform e dagang sebagai platform untuk memasarkan produk dan servis mereka seperti hasil laut dan kedai makanan laut oleh PNK kepada pengguna secara terus tanpa melalui orang tengah. Ia juga peluang meningkatkan pendapatan nelayan terutamanya semasa musim tengkujuh dan hujan dan mereka tidak boleh ke luar menangkap ikan.

Media massa khususnya media alternatif dan sosial sangat berpengaruh kepada masyarakat dewasa ini. Justeru, bagi mengimbangi pelaksanaan dasar dan program yang

disalurkan kepada nelayan oleh LKIM dan PNK, maka sudah tiba masanya suatu transformasi perlu dilakukan bagi memperbaiki kualiti perkhidmatan, meningkatkan keberkesanan dan kecekapan pelaksanaan dasar, penyaluran maklumat, pengesanan identiti nelayan dan sebagainya melalui transformasi ICT. Beberapa tindakan yang boleh dipertimbang ke arah tujuan tersebut iaitu penggunaan sensor RFID dan QR Code. Penggunaan sensor RFID dan QR Code boleh diintegrasikan kepada Sistem Maklumat Subsidi Bot Nelayan bertujuan menambah baik kawalan terhadap subsidi berkaitan ESHN, IHTI dan skim subsidi diesel dan petrol dan SOP di pihak LKIM dalam penyaluran bantuan dan subsidi kepada kumpulan nelayan yang berkaitan.

Saranan di atas dikemukakan berdasarkan Laporan Ketua Audit Negara (LKAN) 2020 Siri 1, di mana LKIM telah mendapat beberapa teguran dari segi penyaluran kewangan kepada pihak yang berkenaan. Berdasarkan LKAN Tahun 2020 Siri 1 itu, LKIM didapati membuat pembayaran EHSN berjumlah RM24,571.00 kepada nelayan yang sudah meninggal dunia. Dalam pada itu, LKIM dikesan membayar skim subsidi diesel dan petrol berjumlah RM2.12 juta kepada pemilik vesel perikanan yang tidak mengisytiharkan hasil tangkapan ikan. Selain itu, LKIM turut melakukan pembayaran IHTI sebanyak RM21,392.00 kepada nelayan yang meninggal dunia (Laporan Ketua Audit Negara, 2020).

Jadi, bagi menambah baik SOP bagi bayaran ESHN dan IHTI, maka teguran oleh LKAN 2020 di atas perlu diberi perhatian. Pada tahun 2020, penerima ESHN adalah seramai 39,089 orang dengan nilai RM100,703,500.00 manakala penerima subsidi diesel dan petrol adalah seramai 48,960 orang melibatkan 300,352,070 liter diesel dan 35,025,444 liter petrol yang kedua-duanya bernilai RM6,499,9547.34. Manakala, pemborong menerima subsidi sebanyak 60 juta liter (Laporan Ketua Audit Negara, 2020).

Penggunaan sensor RFID kepada Sistem Maklumat Subsidi Bot Nelayan boleh membantu LKIM menguatkuasakan tindakan senarai hitam dan sekatan bekalan minyak melalui skim subsidi diesel dan petrol terhadap pemilik vesel yang gagal atau enggan mengisytiharkan hasil tangkapan ikan kepada LKIM. Selain itu, LKIM juga disyorkan memastikan penambahbaikan sistem yang terbabit dilaksanakan dengan mempunyai ciri keselamatan, boleh dipercayai dan pelan kesinambungan perkhidmatan. Penggunaan QR Code semasa nelayan menerima bantuan, subsidi dan sebagainya dapat mengurangkan kesilapan manual yang berlaku dan data boleh dikemaskini secara masa nyata dalam pangkalan data nelayan.

Dengan pembinaan sistem *online* (dalam talian) seperti Sistem Pengurusan dan Kawalan yang bakal dibangunkan oleh LKIM bagi menambah baik kawalan ke atas subsidi kepada nelayan dan mengintegrasikan sistem maklumat yang digunakan LKIM seperti e-Dana, e-Nelayan, e-Kawalselia dan e-Pengambilan. Sistem pengurusan maklumat seperti Sistem Pengurusan dan Kawalan LKIM adalah istilah yang digunakan secara meluas untuk sistem yang mempunyai 3 (tiga) sumber utama yang diperlukan untuk pengurusan yang lebih berkesan.

Sistem Pengurusan dan Kawalan ini terdiri daripada manusia, maklumat, dan teknologi, sama ada dari luar atau dalam organisasi, di mana keutamaannya adalah manusia. Sistem adalah koleksi kaedah pengurusan maklumat yang melibatkan automasi komputer yang terdiri daripada *perisian* dan *perkakasan* yang menyokong dan juga meningkatkan kualiti dan kecekapan operasi dan proses membuat keputusan oleh pengurusan LKIM di peringkat operasi. Ia boleh dipantau secara *realtime* oleh pengurusan negeri dan pusat. Justeru, dicadangkan agar sistem yang dibangunkan itu perlu mengikut standard ICT yang ditetapkan oleh MAMPU (Unit Pemodenan Tadbiran dan Perancangan Pengurusan Malaysia) dan piawaian standard keselamatan Cybersecurity Malaysia.

Pembangunan Sistem Pengurusan dan Kawalan mempunyai kemampuan untuk mengintegrasikan teknologi IOT (*Internet of Things*) yang ada dalam dalam telefon pintar

masyarakat nelayan yang berada di bawah persatuan nelayan kawasan (PNK). Justeru, pengenalan dan pengintegrasian sensor RFID dan penggunaan QR Code bagi memastikan data Sistem Maklumat Subsidi Bot Nelayan seperti ESHN, IHTI dan skim subsidi diesel dan petrol serta SOP di pihak LKIM boleh dilaksanakan dengan sistematik dalam penyaluran bantuan-bantuan itu kepada kumpulan nelayan yang berkaitan pada masa hadapan.

Selain itu, bayaran balik pinjaman dipotong melalui hasil. Dengan adanya sistem maklumat ini juga, maka proses kawalan pembayaran boleh dibuat dengan lebih cekap kerana maklumat di dalam pangkalan data subsidi nelayan adalah terkini dan seragam di semua peringkat operasi LKIM. Justeru, bayaran ansuran pinjaman nelayan dapat dikutip setiap kali pendaratan hasil berlaku. Kaedah ini boleh mengelak tunggakan bayaran seperti yang berlaku sekarang di sesetengah negeri. Melalui kaedah ini ia juga dapat mengelak berlakunya masalah data yang tidak seragam dan membantu pihak pentadbir LKIM memantau serta mengelak berlakunya lebihan bayaran subsidi seperti dalam Laporan Ketua Audit Negara 2020 daripada berulang pada masa hadapan.

Adalah diharap kesemua cadangan ini mampu meningkatkan integriti data berkaitan keperluan masyarakat nelayan yang bernaung di bawah persatuan nelayan dan ia bakal memudahkan Lembaga Kemajuan Ikan Malaysia (LKIM) mengurus tadbir keperluan masyarakat nelayan dan segala keperluan dan maklum balas dari mereka dapat diterima secara dalam talian. Ini bakal meningkatkan kepuasan masyarakat nelayan terhadap dasar dan polisi kerajaan melalui LKIM tanpa mengambil kira perubahan yang berlaku dalam sosio politik Malaysia. Selain itu ipenggunaan telefon pintar dan media sosial ini membuka peluang kepada masyarakat nelayan untuk menggunakan media sosial dan platform e dagang sebagai platform untuk memasarkan produk dan servis mereka seperti hasil laut dan kedai makanan laut oleh PNK kepada pengguna secara terus tanpa melalui orang tengah. Ia juga peluang meningkatkan pendapatan nelayan terutamanya semasa musim tengkujuh dan hujan dan mereka tidak boleh ke luar menangkap ikan.

RUJUKAN

- Abd Latib, Noor Aznaim and Izham, Siti Sarah (2021) *Isu dan cabaran pembelian barang fizikal atas talian sepanjang pandemik COVID-19 / Noor Aznaim Abd Latib and Siti Sarah Izham*. Journal of Contemporary Islamic Studies (JCIS), 7 (2): 20. pp. 133-152. ISSN (e-ISSN) :0128-0902
- Salleh, M. A. M., Ekhwan, Z. I., & Salman, A. (2019). Mudah guna dan manfaat aplikasi WhatsApp terhadap hubungan antara peribadi masyarakat dan polis. *Jurnal Komunikasi: Malaysian Journal of Communication*, 35(4), 135-154.
- Ismail, F. N., & Mokhtar, A. (2021, March 31). Penyelidikan Empirikal Mengenai Penerimaan Pembayaran Kod Qr Dalam Kalangan Pengguna Telefon Pintar Malaysia. *Jurnal Wacana Sarjana*,
- Rushdi M N & L Z K (2022). Security Intruder Detection System Using IoT *International Journal of Undergraduate Research* J(3) page 37-42
- Sandy Andhana Surbakti, Solly Aryza, & Adi Sastra P Tarigan. (2022). AN IMPROVING FISHERMAN PRODUCT QUALITY AND FISHING PERFORMANCE BASED ON IOT. *INFOKUM*, 10(03), 405-410. Retrieved from <http://infor.seaninstitute.org/index.php/infokum/article/view/738>
- Lembaga Kemajuan Ikan Malaysia (LKIM). *Laporan Tahunan 2014, 2015, 2016, 2017, 2018, 2019 dan 2020*. Diakses dari <https://www.lkim.gov.my/laporan-tahunan>. (28 Ogos 2022).
- Astroawani Diakses dari <https://www.astroawani.com/berita-bisnes/edagang-kekal-prestasi-selepas-pembukaan-sektor-ekonomi-negara-365641>(27 Ogos 2022).

- Nadia F (2017) PENGGUNAAN MEDIA SOSIAL DALAM DUNIA TANPA SEMPADAN: SUATU KEBAIKAN ATAU KEBURUKAN? Diakses dari <https://www.ilkap.gov.my/download/kertaspenyelidikan/PMSDDTS18122017.pdf>
- Ahmad, M. Z. (2017). *Sikap dan Persepsi Masyarakat Nelayan terhadap Pembangunan Pelancongan di Kuala Kedah: ke arah Pembangunan Lestari*. (Tesis PhD yang tidak diterbitkan) Universiti Kebangsaan Malaysia, Bangi.
- Allen, L. R., Long, P. T., Perdue, R. R. and Kielselbach, S. (1988). The impacts of tourism development on residents perceptions of community life. *Journal of Travel Research*, 26(1), 16-21.

Memahami Konsep Kedaulatan Watan dalam Kalangan Keluarga Malaysia

Siti Khatijah Yasin

Universiti Sultan Zainal Abidin (UniSZA), Terengganu, Malaysia
sitikhatijahy@yahoo.com

Fadzli Adam

Universiti Sultan Zainal Abidin (UniSZA), Terengganu, Malaysia
fadzliadam@unisza.edu.my

Mohd Ridhuan Tee Abdullah

Universiti Sultan Zainal Abidin (UniSZA), Terengganu, Malaysia
ridhuantee99@yahoo.com

Nik Fadhilah Nik Him

Universiti Sultan Zainal Abidin (UniSZA), Terengganu, Malaysia
nikfadhiey@gmail.com

Nurhazilah Mamat

Universiti Malaysia Terengganu (UMT), Terengganu, Malaysia
gsk2591@pps.umt.edu.my

ABSTRAK

Artikel ini akan melihat sejauh mana memahami konsep kedaulatan watan dalam kalangan Keluarga Malaysia. Malaysia merupakan sebuah negara persekutuan yang berteraskan dua perjanjian utama iaitu pada peringkat Persekutuan Tanah Melayu dan Malaysia selaras dengan prinsip kedaulatan yang telah termaktub dalam kedua-dua perjanjian tersebut. Perkataan kedaulatan atau sovereignty bermaksud kuasa tertinggi yang dimiliki oleh sesebuah negara. Kefahaman dan tahap pengetahuan Keluarga Malaysia iaitu bagi semua kaum perlu ditekankan bagi lebih memahami konsep kedaulatan watan dalam kehidupan mereka. Objektif kajian ini memahami kedudukan Islam sebagai agama tertinggi dalam negara serta pengetahuan mengenai institusi raja dan sultan. Selain itu, objektif kajian ini juga mengenal pasti hak keistimewaan orang Melayu dalam perlembagaan Malaysia. Kaedah yang digunakan dalam penulisan ini adalah analisis konseptual melalui analisis dokumen terhadap penulisan dan kajian lepas yang berkaitan dengan skop kajian ini. Hasil dapatan yang diperoleh mendapati kefahaman tentang konsep kedaulatan watan perlu diperluaskan kepada Keluarga Malaysia agar kesepaduan antara kaum lebih utuh dan harmoni dengan berlandaskan perlembagaan yang telah ditetapkan. Kedaulatan watan merupakan kuasa agung yang perlu dipertahankan demi menjaga kedaulatan negara daripada ancaman musuh negara.

Kata kunci: *Kedaulatan Watan, kedudukan Islam, keistimewaan orang Melayu, Institusi Raja*

PENGENALAN

Perkataan kedaulatan atau *sovereignty* adalah membawa maksud kuasa tertinggi yang dimiliki oleh sebuah negara serta kemunculan konsep ini dipengaruhi oleh proses pertumbuhan negara moden. Kedaulatan negara turut dikaitkan dengan konsep ketinggian perlembagaan dan ini bermaksud undang-undang yang diluluskan selepas hari merdeka dan yang berlawanan dengan perlembagaan hendaklah terbatal setakat mana yang berlawanan. Kedaulatan dalam konteks

barat dan Islam merupakan satu konsep yang mempunyai implikasi kepada sistem politik dan prinsip perundangan sesebuah kerajaan atau pemerintah (Curzon, 2007 & Wan Ahmad Fauzi, 2017). Kedaulatan adalah merujuk kepada konsep kuasa agung yang mencorakkan prinsip perundangan dalam entiti politik.

Konsep kuasa sama ada dalaman atau luaran dalam melaksanakan keputusan politik, menggubal dan menguatkuasakan undang-undang berdasarkan kedaulatan watan serta kedudukan tersebut masih dihormati dan diabsah oleh semua pihak dan wilayah kekuasaannya (Wan Ahmad Fauzi, 2017). Namun menurut Black's Law Dictionary (1990), kedaulatan ialah kuasa mutlak, tertinggi dan tidak terkawal. Pandangan Wan Ahmad Fauzi (2017) menjelaskan kedaulatan juga adalah kuasa mengawal selia urusan dalamannya tanpa telunjuk asing dalam hal-hal politik dalam masyarakat agar negara kekal berdaulat dan bebas daripada cengkaman kuasa luar.

Konsep kedaulatan negara tertakut dalam Perkara 181(1) Perlembagaan Persekutuan. Peruntukan Perlembagaan yang merangkumi kedaulatan, prerogatif, kuasa dan bidang kuasa pembesar-pembesar memerintah Negeri Sembilan di bawah wilayah-wilayah mereka sebagaimana yang telah ada dan dinikmati hingga kini adalah sudah tetap dan tidak terjejas. Seperti yang sedia maklum, kedaulatan negara bukanlah ciptaan Perlembagaan Persekutuan atau perlembagaan moden negeri-negeri, namun ia berteraskan konsep kedaulatan watan dan masih terpelihara dalam Perlembagaan Persekutuan. Namun demikian, Keluarga Malaysia merentasi sempadan agama, bangsa dan kaum merupakan lambang kesepaduan dan keutuhan yang diamalkan berlandaskan perlembagaan yang dibina. Ini turut diperkukuhkan lagi dengan tiga teras utama iaitu keterangkuman, kebersamaan dan kesyukuran yang diterangkan dalam konsep Keluarga Malaysia. Semua kaum dan agama disatukan di bawah konsep Keluarga Malaysia tanpa membezakan fahaman politik dan kesaksamaan ini mengikut Perlembagaan Malaysia dan Rukun Negara.

KONSEP KEDAULATAN WATAN

Takrifan bagi kedaulatan watan adalah merupakan kekuasaan agung bersifat watan Tanah Melayu. Kedaulatan watan adalah merujuk kepada kerangka kedaulatan bersumberkan Islam yang terbina zaman Kesultanan Melayu Melaka, Wan Ahmad Fauzi (2017). Kedaulatan dikuatkuasakan sama ada lebih awam seperti disaksikan melalui penemuan Batu Bersurat Terengganu atau selepas terbubaranya Kesultanan Melayu Melaka melalui pemakaian Undang-Undang Johor, Undang-Undang Pahang, Undang-Undang 99 Perak dan Undang-Undang Kedah. Kedaulatan watan itu bersumberkan ajaran Islam yang mengimani bahawa hak penerapan undang-undang tertinggi adalah mutlak Allah SWT seperti dijelaskan dalam al-Quran dan al-Sunnah.

Malaysia mengamalkan kuasa perundangan persekutuan adalah terletak dalam Parlimen iaitu majlis tertinggi yang menggubal undang-undang. Majlis tertinggi adalah terdiri daripada 'Lord' atau 'Raja' dan dua dewan iaitu Dewan Rakyat dan Dewan Negara. Kuasa perundangan ini bermaksud kuasa untuk membuat dan membatalkan undang-undang. Sistem Parlimen Malaysia terbahagi kepada tiga bahagian seperti yang telah ditulis dalam senarai Perlembagaan Persekutuan iaitu Yang di-Pertuan Agong dan dua Majlis yang dinamakan Dewan Negara dan Dewan Rakyat. Pandangan Mohd Ainuddin et.al (2004) menjelaskan perlembagaan adalah sebagai kumpulan undang-undang dan peraturan yang akan menentukan organisasi kerajaan dan pembahagian kuasa antara badan-badan pemerintah. Fungsi perlembagaan adalah memastikan wujudnya keamanan antara ahli masyarakat berpandukan

peraturan-peraturan yang menjadi panduan kepada semua ahli masyarakat. Namun begitu, masih ramai masyarakat Malaysia tidak memahami dan mengetahui konsep kedaulatan watan yang telah ditulis dalam perlembagaan negara.

Perlembagaan persekutuan diperkenalkan pertama kali sebagai Perlembagaan Persekutuan Tanah Melayu pada hari kemerdekaan iaitu pada 31 Ogos 1957 serta berikutnya diperkenalkan sebagai Perlembagaan Persekutuan Malaysia pada hari Malaysia iaitu pada 16 September 1963. Perlembagaan Persekutuan Malaysia terhasil sejak kemerdekaan dan masih mengekalkan peruntukan-peruntukan penting dalam perlembagaan. Terdapat lima peruntukan utama dalam perlembagaan yang telah digariskan iaitu isu Bahasa Melayu, agama Islam, hak istimewa orang Melayu, kewarganegaraan dan hak asasi (Wan Ahmad Fauzi, 2017). Jelas menunjukkan kelima-lima peruntukan ini tidak boleh dipertikaikan dan diubah oleh mana-mana pihak yang berkepentingan kerana telah termaktud dalam perlembagaan Malaysia.

KEDUDUKAN ISLAM SEBAGAI AGAMA TERTINGGI DALAM NEGARA

Keunikan Keluarga Malaysia adalah sebuah negara yang multi-etnik dan kepelbagaian ini telah termaktub dalam perlembagaan. Jelas sekali, Perlembagaan Persekutuan dalam Artikel 3 telah memperuntukan agama Islam sebagai agama persekutuan, namun agama-agama lain bebas diamalkan oleh para penganutnya tanpa sebarang sekatan (Ahmad Tarmizi, 2014). Bagaimana pandangan Talib & Gill (2012) mengatakan bahawa hampir tidak ada negara di dunia yang penduduknya hanya mengamalkan satu agama sahaja. Malaysia sangat unit kerana kepelbagaian agama dan bangsa yang wujud telah menguatkan lagi konsep Keluarga Malaysia dengan kesepaduan dan kerjasama yang utuh demi menjamin kelangsungan hidup untuk semua.

Bahagian 1 Perlembagaan Persekutuan menjelaskan kedudukan agama Islam sebagai agama persekutuan dan ini dijadikan struktur asas Perlembagaan. Ini menunjukkan pentingnya peruntukan Islam dalam struktur Perlembagaan, Shamrahayu, (2018). Hal ini menggambarkan kedudukan Islam berada pada tahap tertinggi dalam Perkara 3 Perlembagaan Persekutuan dan perkara ini dicapai hasil persetujuan ketika negara mencapai kemerdekaan (Zainal Zainuddin, 2018). Oleh itu, agama Islam menjadi agama rasmi negara dan agama lain bebas mengamalkan agama masing-masing selagi tidak melanggar peruntukan yang termaktub dalam perlembagaan.

Namun begitu, pelbagai taksiran dilontarkan oleh sesetengah pihak dalam mengklasifikasikan konsep hak asasi manusia berdasarkan penilaian mereka sendiri. Faktor ini sering menjadi pertikaian terutama apabila menyentuh perkara sensitif berkaitan dengan kebebasan beragama (Khairul Azhar & Rushdi, 2017). Namun kini, pertikaian hangat antara masyarakat muslim dan non-muslim adalah sejauh mana kedudukan Islam sebagai agama rasmi dapat melunaskan keperluan hak asasi manusia bagi semua pihak. Namun, peruntukan hak-hak tersebut sememangnya menepati kandungan persekutuan dan prinsip Islam. Namun demikian, perkara ini dieksploitasikan dengan menimbulkan isu-isu sensasi oleh pihak tertentu selaras dengan kelemahan pelaksanaan oleh pihak yang bertanggungjawab.

Islam dalam perlembagaan merupakan simbiosis antara kepercayaan dan pegangan majoriti bangsa Melayu Malaysia. Campur tangan terhadap isu agama memberi implikasi yang besar terhadap orang Melayu Islam kerana baginya agama tidak dapat dipisahkan daripada kehidupan seharian mereka. Jika ditelusuri soal kepercayaan dan keimanan adalah urusan seseorang. Walau bagaimanapun, perkara sebegini boleh memberi kesan kepada ketenteraman awam khususnya yang melibatkan ketegangan antara kaum (Nazri Muslim, 2012). Namun

demikian, peruntukan Islam dalam perlembagaan ini dilihat dalam Perkara 3, Perkara 8, Perkara 11, Perkara 12, Perkara 121, Perkara 150 dan kedudukan Yang di-Pertuan Agong dalam hal ehwal agama Islam (Perlembagaan Persekutuan)

Kajian ini menjelaskan peruntukan Islam dalam Perlembagaan Persekutuan termaktub dalam tujuh perkara berikut:

Pertama: Peruntukan di bawah perkara 3 menjelaskan bahawa Islam adalah agama persekutuan dan pada masa yang sama juga memberikan hak kepada orang bukan Islam untuk mengamalkan agama mereka dengan aman dan damai di Malaysia. Selain itu, Perkara 3 juga menjelaskan kedudukan Raja-Raja sebagai ketua agama di negeri-negeri melainkan negeri yang tidak mempunyai raja. Sesuatu perkara yang meliputi seluruh persekutuan yang berkaitan dengan Islam, maka kuasa Yang di Pertuan Agong akan mewakili Raja-Raja setelah dipersetujui oleh Majlis Raja-Raja. Kedudukan Raja-Raja dalam Perkara 3 juga menyentuh tentang Yang di Pertuan Agong adalah ketua agama Islam bagi negeri-negeri Melaka, Pulau Pinang, Sabah dan Sarawak. Dalam Perkara 3 juga menyatakan bahawa bagi Wilayah Persekutuan, Parlimen boleh membuat undang-undang berkenaan hal ehwal Islam dan menubuhkan Majlis bagi menasihati Yang di Pertuan Agong berkenaan hal ehwal agama Islam. Selaras dengan Perkara 3 ini, semua negeri dalam persekutuan kecuali Sarawak juga telah menjadikan Islam sebagai agama negeri.

Kedua: Peruntukan di bawah Perkara 8 menjelaskan bahawa semua orang adalah sama rata di sisi undang-undang dan berhak mendapat perlindungan yang sama rata di sisi undang-undang. Namun begitu, terdapat pengecualian seperti dibenarkan dengan nyata dalam perlembagaan iaitu tiada perbezaan boleh dibuat berdasarkan agama, kaum, keturunan, tempat lahir atau jantina dalam mana-mana undang-undang atau pelantikan bagi sesuatu jawatan di bawah pihak berkuasa awam. Pengecualian ini jelas dalam pelantikan yang berkenaan dengan sesuatu agama itu sendiri.

Ketiga: Peruntukan Perkara 11 menjelaskan bahawa setiap orang berhak menganuti dan mengamalkan agama masing-masing, tiada sesiapa pun boleh dipaksa membayar apa-apa cukai jika diperuntukan bagi maksud yang lain dari agamanya sendiri termasuklah menubuh, menyelenggara atau memiliki harta atau institusi dan undang-undang negeri dan undang-undang wilayah persekutuan boleh mengawal atau menyekat pengembangan apa-apa kepercayaan agama dalam kalangan orang Islam.

Keempat: Peruntukan Perkara 12 menjelaskan bahawa setiap kumpulan agama berhak menubuh dan menyelenggara Yayasan untuk pelajaran kanak-kanak mengenai agama masing-masing, undang-undang persekutuan dan undang-undang negeri boleh mengadakan bantuan kewangan khas bagi menubuh dan menyelenggara Yayasan Islam atau bagi mengajar tentang agama Islam kepada orang Islam, tiada sesiapa dipaksa mengambil bahagian dalam upacara agama selain agamanya dan agama bagi seseorang yang berumur kurang dari 18 tahun ditentukan oleh ibu bapa atau penjaganya.

Kelima: Peruntukan Islam disentuh dalam Perkara 121 (1A) jelas melalui peruntukan ini menjelaskan bahawa Mahkamah Tinggi Sivil tidak boleh mempunyai bidang berkenaan dengan apa-apa perkara dalam bidang kuasa Mahkamah Syariah. Hal ini kerana sebelum pindaan itu dibuat terdapat beberapa kes (seperti wakaf, penjagaan anak, mungkir janji untuk berkahwin dan lain-lain) yang Mahkamah Sivil telah

membuat keputusan berkenaan perkara yang termasuk dalam bidang kuasa Mahkamah Syariah dan adakalanya telah mengubah keputusan yang dibuat di Mahkamah Syariah.

Keenam: Peruntukan di bawah Perkara 150 (6A) jelas meletakkan hal ehwal Islam walaupun dalam keadaan darurat yang memberi kuasa kepada pihak eksekutif untuk membuat undang-undang yang pada keadaan biasa, undang-undang hanya boleh digubal di Parlimen dan kerajaan pusat boleh mengambil alih pemerintahan kerajaan negeri. Walaupun kuasa darurat yang sangat luas tetapi tidak termasuk perkara yang berhubung dengan agama Islam dan adat istiadat Melayu. Keadaan ini menunjukkan hal yang berkaitan dengan agama Islam diberi status yang tinggi dalam perlembagaan.

Ketujuh: Peranan Yang di-Pertuan Agong juga boleh dimasukkan dalam ruang lingkup Islam dalam perlembagaan. Walaupun perlembagaan tidak menetapkan baginda sebagai ketua agama bagi seluruh persekutuan, perlembagaan menetapkan tanggungjawab ke atas baginda supaya menjaga Islam.

PENGETAHUAN MENGENAI INSTITUSI RAJA DAN SULTAN DALAM PERLEMBAGAAN PERSEKUTUAN

Kedaulatan Raja-raja Melayu adalah suatu yang dijamin dan masih terpelihara sehingga kini dan termaktub dalam Perkara 181 Perlembagaan Persekutuan. Oleh itu, konsep kedaulatan berdasarkan peruntukan “sebahagian yang telah ada dan dinikmati hingga kini adalah tetap dan tidak terjejas” yang termaktub dalam Perkara 181(1) Perlembagaan Persekutuan. Peruntukan tersebut merujuk kedaulatan raja-raja Melayu “sebagaimana yang telah ada”, maka makalah ini menggunakan kaedah sejarah perundangan untuk mentafsirkan konsep kedaulatan raja-raja Melayu. Konsep kedaulatan raja-raja Melayu di sisi Perlembagaan Persekutuan amat penting sebagai premis yang paling sahih untuk menjelaskan prinsip perundangan negara (Wan Ahmad Fauzi, 2017).

Selain itu, menurut Abdul Aziz Bari (2008), kaedah pentafsiran kedaulatan raja-raja Melayu melampaui peruntukan bertulis Perlembagaan Persekutuan kerana legitimasi kewujudan sesebuah negeri dan sejarahnya adalah berasaskan serta bersandarkan raja. Menurutnya lagi, mengikut teori undang-undang tulen Hans Kelsen, kuasa dan pengaruh sebenar raja itu terletak pada diri dan institusi, bukan pada peruntukan perlembagaan dan undang-undang yang lebih bersifat formal. Dengan kata lain, raja-raja Melayu masih memiliki kuasa tersimpan. Namun begitu, ada sesetengah masyarakat tidak memahami dan mengetahui fungsi institusi raja dan sultan dalam setiap negeri malah ada sesetengah pihak mempertikaikan institusi ini sehingga menimbulkan kekeliruan dalam masyarakat.

Kedaulatan raja-raja Melayu seperti dinyatakan sebelum ini adalah kekal dengan ciri asal berdasarkan adat Melayu dan bukanlah ciptaan baharu kesan Perjanjian Negeri 1948. Adat Melayu adalah undang-undang dalam masyarakat Melayu sejak zaman-berzaman yang meliputi sistem politik dan undang-undang yang dikuatkuasakan (Jelani Harun, 2008). Ini disokong oleh pandangan Simon (1995) yang mana kepentingan isu kedaulatan raja-raja Melayu jelas dinyatakan dalam teks cadangan berhubung dengan kerajaan negeri. Raja-raja Melayu menuntut Raja Britain mengiktiraf mereka sebagai raja yang berdaulat dan merdeka. Terdapat lima perkara penting yang perlu difahami untuk mengenal pasti kedaulatan yang dijunjung oleh mana-mana kerajaan moden pada hari ini bagi kedaulatan raja-raja Melayu dalam Perlembagaan Persekutuan (Wan Ahmad Fauzi, 2017) antaranya seperti berikut:

1. Raja-raja Melayu adalah penganut Islam, kekal sejak zaman kesultanan Melayu Melaka hingga hari ini.
2. Raja-raja Melayu yang menandatangani atau menginstitusikan Perjanjian Negeri 1948 dan Perjanjian Persekutuan Tanah Melayu 1948.
3. Perjanjian Negeri 1948 ialah batu asas perlembagaan moden kerajaan Melayu dan Perlembagaan Persekutuan Tanah Melayu 1957.
4. Kuasa Perjanjian Persekutuan Tanah Melayu 1948 dan Perlembagaan Persekutuan Tanah Melayu 1957 dikurniakan dan dikuatkuasakan melalui kedaulatan sembilan orang raja-raja Melayu yang mendirikan Persekutuan Tanah Melayu.
5. Kedaulatan raja-raja Melayu bukanlah ciptaan Perlembagaan Persekutuan Tanah Melayu 1957 tetapi susur-galur diwarisi daripada Kesultanan Melayu Melaka.

KEISTIMEWAAN ORANG MELAYU DALAM PERLEMBAGAAN

Definisi Melayu sangat luas untuk dijelaskan dan jika diambil dalam pengertian sejarah dan sosiobudaya namun meliputi mereka yang mendiami kepulauan Melayu (Nazri Muslim, 2013). Walaupun terdapat pelbagai suku bangsa, bahasa dan loghat, namun ahli-ahli Bahasa dan budaya menganggap mereka sebagai satu kumpulan yang sama iaitu keturunan Melayu (Syed Husin Ali, 2008). Merujuk orang Melayu dalam Perlembagaan Persekutuan Malaysia ditakrifkan Perkara 160 (2) sebagai seseorang yang beragama Islam yang lazimnya bertutur dalam Bahasa Melayu serta adat istiadat Melayu dan beragama Islam. Dibawah Perkara 89(6) bahawa Melayu termasuklah seseorang yang disifatkan sebagai seorang Melayu bagi maksud merizabkan tanah di bawah undang-undang bagi negeri di mana ia bermastautin. Namun, terdapat beberapa perkara yang boleh dibincangkan dalam peruntukan di atas antaranya untuk menjadi seorang Melayu bagi istilah Perlembagaan tidak semestinya seseorang itu berketurunan Melayu. Malah seorang India boleh dianggap sebagai Melayu sekiranya ia menganut agama Islam, menjadi kelaziman bertutur dalam Bahasa Melayu.

Dalam pentadbiran negara perkara 152, perlembagaan Persekutuan dan Akta bahasa Kebangsaan 1963/67 memperuntukkan bahawa bahasa Melayu sebagai bahasa kebangsaan hendaklah digunakan sebagai bahasa rasmi dalam negara. Bahasa rasmi yang dimaksudkan ialah bahasa yang digunakan dalam semua urusan rasmi yang meliputi wacana lisan dan tulisan pada peringkat kerajaan persekutuan, kerajaan-kerajaan negeri, badan-badan berkanun dan pihak berkuasa tempatan. Wacana lisan rasmi termasuklah ucapan, taklimat, mesyuarat, ceramah, perbincangan, syarahan, pentadbiran dan yang seumpamanya. Wacana tulisan rasmi pula meliputi urusan surat-menyurat pentadbiran, minit mesyuarat, memo, kertas cadangan, laporan, pekeliling dan sebagainya (Safiah, Shahdatulakma & Azlina, 2016).

Namun ada polimik yang ditimbulkan oleh sesetengah bukan Melayu menganggap kedudukan istimewa orang Melayu ini adalah sebagai sesuatu yang tidak dikaitkan dengan kewarganegaraan yang diberikan pada masa itu tetapi terdiri daripada imigran (Nazri Muslim et al, 2013). Kemungkinan besar mereka beranggapan bahawa kewarganegaraan adalah sesuatu yang diberikan secara automatik. Bagi mereka kompromi ini terikat kepada masa tertentu dan tidak lagi relevan (Zainal Kling, 2008). Namun, bagi bangsa Melayu menganggap peruntukan sedemikian sebagai sesuatu yang suci, manakala bagi sesetengah orang bukan Melayu

mempersoalkan sama ada peruntukan tersebut adalah berkaitan dan mengikat sehingga ke hari ini (Just Faaland, Jack Parkinson & Rais Saniman, 2002).

Menurut Milne dan Mauzy (1992) menjelaskan kedudukan istimewa orang Melayu terangkumi empat perkara iaitu tanah rizab Melayu, kuota untuk lesen dalam perniagaan, perkhidmatan awam, biasiswa dan geran Pendidikan. Bagi Shad Salem Faruqi (2003), kedudukan istimewa orang Melayu ini meliputi Perkara 153, Perkara 80 dan 90, Perkara 8(5), persempadanan kawasan pilihan raya dalam jadual ke 13 yang memberi kelebihan politik kepada pengundi Melayu luar bandar dan peruntukkan di bawah perlembagaan setiap negeri kecuali Pulau Pinang, Sabah, Sarawak dan Melaka yang memperuntukkan bahawa Menteri Besar dan Setiausaha Kerajaan Negeri mestilah orang Melayu. Oleh itu, peruntukan istimewa orang Melayu hanya membincangkan mengenai Perkara 153, Perkara 89 dan 90, Perkara 8(5). Bagi Just Faaland, Jack Parkinson dan Rais Saniman (2002), kedudukan ini merujuk kepada Perkara 3, Perkara 32, Perkara 89, Perkara 90, Perkara 152 dan Perkara 153. Perkara 89 dan 90, Perkara 8 (5) dan Jadual ketiga belas. Oleh itu, dalam artikel ini, peruntukan istimewa orang Melayu hanya membincangkan tentang Perkara 153, Perkara 89 dan 90, Perkara 8(5) (f) dan Jadual Ketiga belas tentang persempadanan kawasan pilihan raya.

Namun begitu, kedudukan dan pelaksanaan keistimewaan orang Melayu dalam Perlembagaan Persekutuan tidak pernah sunyi daripada kritikan dan persoalan kerana etnik bukan Melayu berasa bahawa unsur-unsur tradisi ini menjadikan sistem yang ada tidak demokratik. Walau bagaimanapun, Artikel 153 Perlembagaan Malaysia memberikan tanggungjawab kepada Yang di-Pertuan Agong menjaga hak keistimewaan orang Melayu dan penduduk asal Malaysia iaitu Bumiputera. Akta ini menunjukkan bagaimana kerajaan melindungi kepentingan kumpulan-kumpulan ini dengan mendirikan kuota kemasukan ke dalam perkhidmatan awam, biasiswa dan pendidikan awam. Kedudukan istimewa orang Melayu yang lain termasuklah peruntukan Perkara 89 dan 90 yang memberi kuat kuasa undang-undang perlembagaan kepada undang-undang yang sedia ada yang melindungi tanah rizab orang Melayu daripada diselenggarakan oleh orang bukan Melayu. Kesimpulan yang dapat dijelaskan bahawa artikel 153 Perlembagaan Persekutuan menunjukkan hak keistimewaan orang Melayu meliputi pelbagai perkara termasuklah, hak pendidikan, ekonomi dan sosial.

Kesimpulan yang dapat dijelaskan bahawa artikel 153 Perlembagaan Persekutuan menunjukkan hak keistimewaan orang Melayu meliputi pelbagai perkara termasuklah, hak pendidikan, ekonomi, sosial dan sebagainya. Kewarganegaraan merupakan peraturan-peraturan yang telah ditulis dalam perlembagaan Malaysia dan peruntukkan pemerolehan kewarganegaraan disenaraikan dalam bahagian 3, perkara 14 hingga Perkara 22 Perlembagaan Persekutuan Malaysia. Seseorang boleh mendapatkan kewarganegaraan melalui empat cara iaitu kuatkuasa undang-undang, pendaftaran, permohonan kemasukan dan pencantuman wilayah. Kesemua ciri-ciri tersebut mempunyai huraian tersendiri serta dijelaskan secara terperinci dalam perlembagaan.

RUJUKAN

- Abdul Aziz Bari. (2008). *The monarchy: Symbolism, guardianship and stability*, hlm.180.
- Ahamad Rahim. (2012). *Penilaian Pelaksanaan Kurikulum Sejarah Menengah Rendah Tingkatan Dua*. Tesis PhD. Universiti Kebangsaan Malaysia.
- Ahmad Ali Seman. (2011). *Keberkesanan Modul Pengajaran dan Pembelajaran Sejarah Berteraskan Perspektif Kepalbagaian Budaya terhadap Pembentukan Integrasi Nasional*.cTesis PhD. Universiti Kebangsaan Malaysia.

- Airasian, P. & Gay, L. R. (2003). *Educational Research: Competencies for Analysis and Applications (Sixth Edition)*. Upper Saddle River, NJ: Pearson Education
- Arief Salleh & Yahaya Jusoh. (2015). *Tafsir Maudhu'iy: Politik dan Urus Tadbir*, Kuala Lumpur: Dewan Bahasa dan Pustaka. Hlm. 58.
- Ary, Donald. Et al. (2010). *Introduction to Research in Education (Eight Edition)*. Canada: Nelson Education.
- Aziz Bari. (2000). Kebebasan dan Hak-Hak Asasi di Bawah Perlembagaan Persekutuan. *Malaysian Journal of Law and Society* 4: 87-108.
- Babbie, E. R. (2010). *Introduction to Social Research*. Wadsworth Cengage learning.
- Black's Law Dictionary. (1990). *Ed. Ke-6, Springer*. New York, hlm.252,
- Chua Yan Piaw. (2006). *Kaedah Penyelidikan Buku 1*. Serdang Selangor: McGraw-Hill, (Malaysia) Sdn. Bhd.
- Cooper, D. R., Schindler, P.S. (1998). *Business Research Methods (Sixth Edition)*. McGraw-Hill.
- Creswell, J.W. (1998). *Qualitative Inquiry and Research Design: Choosing Among Five Traditions*. Thousand Oaks, CA: Sage.
- Curzon, L.B. (2007). *Dictionary of Law*. Edisi ke-6. Kuala Lumpur: International Law Book Services.
- Dzuhailmi Dahalan, Nobaya Ahmad, Md. Salleh Hassan, Mariah Muda, Jamilah Othman & Nor Azliza Wanis Abdullah. (2011). The challenges of 1 Malaysia and the reality of youth's involvement with the unity campaign on television. *Australian Journal of Basic and Applied Sciences*, 5(11), 2132-2138.
- Jelani Harun. (2008). *Kajian naskhah Undang-Undang Adat Melayu di London*, (26) Sari 127-148.
- Just Faaland, Jack Parkinson & Rais Saniman. (2002). *Dasar ekonomi baru: Pertumbuhan negara dan pencapaian ekonomi orang Melayu*. Petaling Jaya: SPEKTRA.
- Kamal Azmi Abd Rahman, Norsaleha Mohd Salleh, Nazneen Ismail, Indriaty Ismail & Nurulfathonah Mohd Effendy. (2017). Kajian Awal Tentang Tahap Kefahaman Belia Islam di Lembah Klang tentang Hak Kebebasan Beragama. *Jurnal Penyelidikan dan Inovasi*, 4(2): 173-201
- Khairul Azhar & Rushdi Ramli. (2017). Hak Asasi Non-Muslim di Malaysia menurut perlembagaan persekutuan dan prinsip Islam. *Jurnal Kemanusiaan* 25(3): 18-29.
- Krejcie, R.V & Morgan, D.W. (1970). Determining sample size for research activities. *Educational and Psychological Measurement*, 30(3), 607-610.
- McMillan, J. H & Schumacher, S. (2006). *Research in Education*. Boston: Pearson Education
- McMillan, J. H. (2012). *Educational Research. Fundamentals for the Consumer (Sixth Edition)*. Virginia Commonwealth University: Pearson.
- Milne, R. S and Mauzy D. K. (1992). *Politics and government in Malaysia*. Singapore: Time Book International.
- Mohd Nur Hidayat Hasbollah. (2012). *Hak-hak Non-Muslim dalam Pentadbiran Negara Menurut al-Mawardi*. Bangi: Universiti Kebangsaan Malaysia.
- Mohd Yusri Ibrahim. (2010). *Bimbingan Cepat Analisis Data Penyelidikan: Untuk Pendidikan dan Sains Sosial*. Bandar Ilmu: Kuantan.
- Nazri Muslim, Jamsari Alias, Wan Zulkifli, Azizi Umar & Nasruddin Yunos. (2013). Analisis Peruntukan Orang Melayu Dalam Perlembangan Persekutuan Malaysia Dalam Konteks Hubungan Etnik. *Jurnal Melayu*, 11: 63-78.
- Nazri Muslim. Implikasi Peruntukan Islam dan Orang Melayu dalam Perlembagaan Persekutuan Terhadap Hubungan Etnik di Malaysia. *Jurnal Kemanusiaan*, 19(2): 19-62.

- Nur Syazwani Abdul Talib, Kamarulzaman Abdul Ghani & Nur Azuki Yusuff. (2016). Tahap Pengetahuan dan Sikap Graduan IPT serta Hubungannya Dengan Minat Terhadap Sejarah: Usaha Awal Memupuk Semangat Cinta Negara. *Jurnal Pemikiran Pendidikan*, 7: 57-72.
- Razli Ahmad, Hanum Hassan & Azuddin Bahari. (2013). Persepsi Mahasiswa terhadap Isu-isu Perpaduan: Kajian ke atas Pelajar-pelajar Rangkaian Universiti Teknikal Malaysia (MTUN). *Jurnal Personalia Pelajar*, 16, 15-24.
- Rohana Yusuf. (2004). *Penyelidikan Sains Sosial*. Bentong, Pahang: PTS Publications & Distributors Sdn. Bhd
- Shad Saleem Faruqi. (2003). Affirmative action policies and the constitution. *Journal of Malaysia Studies*, 21(1): 34-35.
- Simon. (1995). *British Relations with the Malay Rulers from Decentralisation to Malayan Independence, 1930-1957*, Kuala Lumpur: Oxford University Press.
- Talib, A.T., & Gill, S.S. (2012). Socio-Religious Tolerance: Exploring the Malaysian Experience. *Global Journal of Human Social Science*, 12(8), 49-54.
- Tuan Pah Rokiah, Hamidi Ismail, Shamsul Anuar Nasarah, Wasitah Mohd Yusof & Zaheruddin. (2017). Nilai Kesetiaan dan Kebanggaan Belia Malaysia Terhadap Negara. *Malaysian Journal of Youth Studies*, 17:11-32.
- Utusan Malaysia, Orang Muda Buta Sejarah. (29 Oktober 2010)
- Wan Ahmad Fauzi Wan Husain. (2017). *Konsep Kedaulatan Raja-Raja Melayu Menurut Kerangka Peribumi*. Majlis Ittihad Ummah Malaysia
- Wan Ahmad Fauzi Wan Husain. (2017). *Konsep Kedaulatan Watan Raja-Raja Melayu Dalam Perlembagaan Persekutuan Malaysia Menurut Sejarah Perundangan*. Tesis Doktor Falsafah, Universiti Kebangsaan Malaysia, Bangi.
- Zainal Kling. (2008). Gerakan memperjuangkan Melayu. Dewan Masyarakat
- Zainal Zainuddin. 2018. Islam dan raja-raja teras kedaulatan negara. Dlm. Abd. Karim Ali, Mohd Roslan Mohd Nor & Baharom Kassim (pnyt.). *Islam Era Malaysia Baharu Dinamika Wacana Kepelbagaian Cabaran*, hlm. 99–116. Shah Alam: Persatuan Ulama' Malaysia dan Imtiyaz Multimedia & Publications
- Shamrahayu A. Aziz. 2018. *Islam Dalam Perlembagaan Persekutuan*. Kuala Lumpur: IKIM Press.

Pemikiran Dato' Perdana Nik Mahmud Tentang Tanggungjawab Politik Orang Islam Dalam Karyanya, *Penyuluh Ketinggian*

Mohd Fadli Ghani
Universiti Teknologi Malaysia

Badlihisam Mohd Nasir
Universiti Teknologi Malaysia

Abdul Hafiz Abdullah
Universiti Teknologi Malaysia

ABSTRAK

*Dato' Perdana Menteri Paduka Raja Nik Mahmud Ismail adalah salah seorang ulama yang cergas dalam kepemimpinan politik dan pentadbiran di negara ini sebelum Perang Dunia Kedua. Perdana Menteri Kelantan ini merupakan seorang murid kepada Sheikh Wan Ahmad al-Fathani (m. 1908) dan kawan rapat Tok Kenali (m. 1933) ketika belajar di Mekah. Di Kelantan, beliau terlibat dengan pentadbiran awam sehingga dilantik sebagai Perdana Menteri Kelantan dalam tahun 1921. Di antara sumbangan terbesar beliau ialah mengasaskan Majlis Agama Islam dan Adat Istiadat Melayu Kelantan (MAIK) pada akhir 1915. Selain mentadbir, beliau juga aktif menghasilkan karya-karya tentang politik, sejarah, agama dan lain-lain berdasarkan pemikiran Islam. Salah sebuah karya beliau yang jarang diperkatakan orang ialah *Penyuluh Ketinggian* yang diterbitkan pada 1936. Melalui buku ini, beliau membahaskan pelbagai kewajipan yang perlu dilaksanakan oleh orang Islam dalam meninggikan mutu hidup mereka, termasuk tanggungjawab yang berkaitan dengan politik. Kajian ini mempunyai tujuan untuk menganalisis pandangan-pandangan Dato' Perdana Nik Mahmud berkait kewajipan dan tanggungjawab politik orang Islam yang dibahaskan oleh beliau di dalam buku *Penyuluh Ketinggian* itu.*

PENGENALAN

Tanggungjawab telah meletakkan manusia pada darjat yang berbeza dengan makhluk lain. Manusia bukan sahaja diberikan tanggungjawab, tetapi pertanggungjawaban di hadapan Tuhan kelak. Beban perlu bertanggungjawab ini sebenarnya cuba dilepaskan oleh manusia, terutama dalam perkembangan masyarakat pasca Zaman Gelap. Dalam pemikiran dunia Barat, yang paling mustahak untuk diperjuangkan ialah kebebasan individu dalam rangka tuntutan hak-hak asasi manusia. Sedangkan pada hakikatnya, hak adalah pihak yang berseberangan dengan tanggungjawab, di mana setiap kali seseorang manusia mempunyai sikap bertanggungjawab, maka terlunaslah hak-hak orang yang berhak itu. Salah satu tanggungjawab yang penting ialah tanggungjawab politik yang apabila ia diabaikan oleh pemerintah akan membawa kepada bencana kezaliman dan jika ia diabaikan oleh rakyat, ia akan meruntuhkan sebuah kedaulatan. Islam mempunyai sudut pandang yang tersendiri tentang konsep tanggungjawab politik ini, sama ada terhadap kerajaan mahupun rakyat.

Perbincangan tentang tanggungjawab politik ini telah disinggung oleh Dato' Perdana Menteri Paduka Raja Nik Mahmud Ismail (1936) di dalam bukunya *Penyuluh Ketinggian*, sebuah buku yang ditulis ketika dunia sedang bergolak pasca Perang Dunia Pertama dan menjelang perubahan politik dunia akibat Perang Dunia Kedua. Nik Mahmud adalah seorang tokoh politik Melayu Islam yang dibiasa dikenali sebagai Dato' Perdana. Beliau mempunyai latar belakang pendidikan agama yang tinggi dan tampil sebagai seorang tokoh

politik yang berwibawa. Selain terlibat dalam kepemimpinan kerajaan di Kelantan, Dato' Perdana juga dikenali kerana banyak menghasilkan buku-buku dalam genre sejarah, politik dan agama. Tulisan ini bertujuan untuk melihat bagaimana pemikiran Dato' Perdana dalam mengungkap persoalan tanggungjawab politik menurut kaca mata Islam terhadap umatnya menerusi salah satu bukunya, *Penyuluh Ketinggian*. Buku ini bukan hanya menjelaskan tentang ketinggian budi, tetapi juga tentang tanggungjawab manusia yang dikelirukan oleh tuntutan-tuntutan hak.

TANGGUNGJAWAB POLITIK: SEBUAH KONSEP UMUM

Tanggungjawab atau *responsibility* adalah berasal dari perkataan Latin, *responsum*, dengan kata kerjanya *responden*, yang pada gilirannya dibentuk dengan awalan re-, yang merujuk kepada idea pengulangan atau kembali, dan kata kerja *spondere* yang bermaksud 'berjanji,' 'terikat' atau 'komited' (ninanelsonbooks.com, 2022). Tanggungjawab membawa maksud pemenuhan kewajipan atau mengambil peduli terhadap sesuatu ketika membuat keputusan atau melakukan sesuatu. Tanggungjawab juga adalah kenyataan yang bertanggungjawab terhadap sesuatu atau seseorang, selain merujuk kepada kewajipan untuk menanggapi sesuatu fakta atau kebenaran. Dalam pandangan Islam, tanggungjawab mempunyai makna yang sejajar dengan perkataan *mas'uliyah*, iaitu sifat integriti atau bertanggungjawab, di mana setiap perbuatan manusia adalah melibatkan hukum agama dan dosa pahala yang akan diadili di akhirat kelak (ppn.kelantan.gov.my). Perkataan tanggungjawab juga biasanya dirujuk kepada perkataan *accountability* dalam bahasa Inggeris yang memberi makna seseorang itu perlu berwaspada dan bertanggungjawab di atas apa yang dilakukannya.

Kamus Dewan (2002: 1371) memberikan definisi perkataan tanggungjawab sebagai kewajipan yang dipikul oleh seseorang atau segala yang wajib ditanggung. Makna ini mempunyai keselarian dengan konsep *at-taklif* dalam pemikiran Islam. Perkataan *at-taklif* adalah berasal dari kata *al-kulfah* yang mempunyai makna penat dan sukar. Wan Z. Kamaruddin dan Ahmad Zuhdi (2009) mengatakan ia bermaksud membebankan sesuatu dengan sesuatu beban atau mengemukakan perintah untuk melakukan sesuatu yang membebankan, sehingga *at-taklif* boleh dikatakan sesuatu yang memenatkan dan menyukarkan atau meletakkan seseorang dalam kesulitan. *At-taklif* boleh disimpulkan sebagai suatu perintah atau suruhan yang membebankan, memenatkan, menyukarkan dan menyulitkan seseorang. Wan Z. Kamaruddin dan Ahmad Zuhdi (2009: 2) yang memetik pandangan al-Baghdadi (m. 329H) telah menjelaskan makna *at-taklif* dengan merujuk kepada perintah (*al-amar*) dan larangan (*an-nahy*) kerana perkara ini sukar untuk dilakukan oleh mukallaf.⁶⁵

Dalam kehidupan politik dan sosial, seseorang anggota masyarakat, sama ada sebagai individu atau ahli kumpulan tertentu dan bagi masyarakat itu sendiri, mereka mempunyai beban, komitmen atau kewajipan yang disebut sebagai tanggungjawab politik dan sosial. Ia adalah tanggungjawab berdasarkan ideologi dan peraturan dalaman entiti, sama ada persatuan, masyarakat mahupun negara. Tanggungjawab politik boleh menjadi positif, dalam pengertian dipaksa untuk mematuhi dan bertindak melakukan sesuatu. Dan ia juga boleh menjadi negatif apabila seseorang itu tidak bertindak atau tidak melakukan sesuatu yang sewajarnya dilakukan dalam melaksanakan tanggungjawab ini. Di dalam sesebuah negara atau komuniti politik, rakyat dan pemerintah saling mempunyai tanggungjawab dalam memastikan semua pihak

⁶⁵ Wan Z Kamaruddin Wan Ali dan Ahmad Zuhdi Ismail, 2009. Konsep Kewajipan dan Tanggungjawab (al-Taklif) Dalam Pemikiran Islam: Penerapan dan Aplikasinya Dalam Kehidupan Masyarakat Muslim. Researchgate.net.

dapat menikmati hak masing-masing, bermula dari tanggungjawab memilih dan mengangkat pemimpin, sehinggalah tanggungjawab untuk mempertahankan kedaulatan negara.

Dalam konteks ini, Islam mengemukakan konsep *at-taklif* dan *mas'uliyah* yang menjelaskan kedudukan tanggungjawab dan pertanggungjawaban yang berlaku secara bersilang di antara rakyat dan pemerintah. Penetapan tujuan penciptaan manusia sebagai khalifah adalah untuk menyatakan tanggungjawab politik yang terbeban di atas seorang manusia dalam menegakkan agama Allah dan mentadbir kehidupan dunia ini berdasar agama tersebut. Abdul Hadi Awang (1995: 58-64) menyatakan bahawa dalam mentadbir urusan dunia, khalifah mempunyai tanggungjawab untuk menegakkan keadilan kepada seluruh manusia, membentuk pandangan mulia dan kebebasan pendapat, menghormati taraf kemanusiaan dan menegakkan keamanan dan kestabilan. Di pihak rakyat pula, mereka mempunyai tanggungjawab untuk menyerahkan amanah kepada pemimpin yang memenuhi syarat kepemimpinan dan memberikan ketaatan kepada mereka. Konsep timbal balik tanggungjawab di antara rakyat dan pemimpin ini terakam dalam Surah an-Nisa', ayat 59-60.

Secara umumnya, tanggungjawab adalah satu perkataan yang mempunyai makna yang sama dengan *mas'uliyah* dan *at-taklif* dalam bahasa Arab dan *responsibility* dan *accountability* dalam bahasa Inggeris, yang memberi makna kewajipan yang terbeban ke atas sesuatu pihak dalam sesuatu perkara. Oleh kerana manusia adalah makhluk sosial bergaul dan mempunyai strata, maka mereka juga terbeban oleh tanggungjawab politik dalam memenuhi keperluan hidup bermasyarakat mereka. Tanggungjawab politik adalah sejumlah tanggungjawab yang ditanggung bersama oleh rakyat dan pemerintah dalam urusan politik dan kenegaraan untuk kepentingan bersama. Islam sebagai satu sistem politik, telah menggariskan dengan jelas konsep tanggungjawab politik ini dan meletakkan manusia dengan satu tujuan politik, iaitu untuk menjadi khalifah di atas muka bumi. Dalam melaksanakan tugas khalifah inilah, konsep *mas'uliyah* atau kebertanggungjawaban menjadi elemen yang penting bagi memastikan manusia mencapai tujuan penciptaannya.

BIOGRAFI RINGKAS DATO' PERDANA NIK MAHMUD

Dato' Perdana Menteri Paduka Raja Nik Mahmud bin Ismail adalah tokoh politik yang paling terkenal di Kelantan pada abad ke-20, terutamanya sebelum merdeka. Beliau yang lebih dikenali sebagai Dato' Perdana adalah murid kepada Sheikh Wan Ahmad al-Fathani di Mekah, sebelum berkhidmat dengan kerajaan sebagai seorang pegawai dan akhirnya dilantik sebagai Perdana Menteri Kelantan pada 1921. Beliau berkhidmat di bawah tiga orang sultan, iaitu Sultan Mohammad IV, Sultan Ismail dan Sultan Ibrahim. Antara jasa terbesar beliau ialah menubuhkan Majlis Agama Islam dan Adat Istiadat Melayu Kelantan (MAIK) pada akhir 1915 yang menjadi nadi pergerakan reformasi pemikiran di Kelantan sebelum Perang Dunia Kedua. Selain menjadi tokoh politik yang cemerlang dan berjasa, Dato' Perdana juga terkenal kerana kebolehannya mengarang dan menyalurkan pemikiran-pemikiran progresif kepada rakyat melalui karya-karyanya, termasuklah buku *Penyuluh Ketinggian* yang diterbitkan dalam tahun 1936 di Tanjung Malim, Perak.

Kelahiran dan asal-usul keluarga

Nik Mahmud bin Nik Ismail bin Wan Mahmud bin Che Seman telah dilahirkan dalam sebuah keluarga aristokrat dan ulama Melayu Kelantan di Kampung Atas Banggol. Kota Bharu dalam tahun 1300H, bersamaan tahun 1882. Ayah beliau, Nik Ismail atau Wan Ismail pada awalnya merupakan seorang ketua kampung yang digelar 'Tok Nebeng' dalam bahasa Siam, sehingga

melekat gelaran Tok Nebeng Nik Ismail pada tubuhnya. Nik Ismail sebenarnya seorang tokoh ulama yang terkenal di Kota Bharu pada zaman Sultan Mansor (1891-1900) yang pernah belajar di Mekah sekitar dekad 1860-an dan menjadi sahabat kepada Sheikh Wan Ahmad al-Fathani. Pada awal zaman Sultan Mansor, beliau dilantik sebagai hakim atau qadhi di Kota Bharu yang menyebabkan namanya mula disebut sebagai Nik Ismail Qadhi. Beliau berkhidmat sebagai qadhi sekitar lima dan meninggal dunia pada 6 Februari 1898. Haji Nik Ismail Qadhi menjadi terkenal kerana beliau adalah antara guru awal Tok Kenali sebelum tokoh ulama ini belajar di Mekah.

Kedudukan Nik Ismail sebagai seorang pemimpin masyarakat adalah bertolak dari kedudukan ayahnya, Wan Mahmud yang merupakan seorang hulubalang kepada Sultan Mohammad II (1837-1886). Menurut sejarah Kelantan, dalam tahun 1832, raja, pembesar dan hulubalang Patani telah berhijrah ke Kelantan setelah negeri tersebut jatuh ke tangan Siam. Selain Tuan Sulong (Sultan Patani) dan Dato' Lela Wan Ahmad (Perdana Menteri), turut berhijrah ke Kelantan ialah Wan Jamal, hulubalang Sultan Patani dalam perang tersebut. Empat orang anak Wan Jamal (atau Jamaluddin) terpaksa berpecah kerana tekanan Siam, di mana seorang anaknya pergi ke Bangkok, seorang ke Terengganu (Wan Jalal), seorang ke Mekah (Wan Idris) dan seorang ke Kelantan (Wan Abdul Samad). Wan Idris yang naik ke Mekah telah kembali ke Kedah menjadi seorang guru agama yang terkenal dengan gelaran Tok Sheikh Jarum (m. 1911). Sedangkan Wan Abdul Samad terpaksa mengubah namanya setelah Kota Bharu diserbu oleh Siam dan Tuan Sulong ditangkap.

Wan Abdul Samad menggunakan nama Wan Mahmud bin Che Seman sebagai strategi untuk mengelirukan Siam melalui pertukaran identiti. Sesuai dengan kedudukannya sebagai anak Wan Jamal, beliau telah dilantik sebagai hulubalang Sultan Mohammad II. Menurut Wan Mohd Saghir Abdullah (1999: 2), Hulubalang Wan Jamaluddin adalah anak kepada Sheikh Wan Abdul Latif bin Sheikh Wan Mohd Syamsuddin bin Sheikh Mohd Faqeh bin Sheikh Wan Mohd Yasiin bin Sheikh Ibrahim al-Hadrami bin Ibar. Menurut Mohd Saghir (1999: 26-27) Ibar adalah gelaran kepada Syed Hussein Jamadil Kubra, ulama pendakwah yang berasal dari India dan berketurunan Hadramaut. Syed Hussein yang mempunyai titihan sehingga Rasulullah SAW itu asalnya adalah putera kepada Syed Ahmad Jalal, gabenor Deccan pada zaman Kesultanan Tughluq di Delhi, India. Syed Hussein Jamadil Kubra dicatatkan datang ke Kelantan pada 1349 dan mengahwini adinda Sultan Mahmud Shah (Raja Bharubasha). Dari perkahwinan ini beliau memperoleh Sheikh Ibrahim al-Hadrami.

Dari salasilah inilah lahirnya Dato' Perdana Nik Mahmud dalam sebuah keluarga ulama yang juga berpengaruh dalam politik. Di sebelah ibunya, Wan Aisyah bin Wan Othman bin Wan Sulaiman bin Wan Othman bin Wan Derahmat bin Wan Abdul Rahman adalah dari keturunan Tok Kaya Pendek bin Faqih Ali yang terkenal itu. Datuknya, Wan Othman adalah adik kepada Mufti Haji Nik Wan Daud Wan Sulaiman, Mufti Kelantan sejak penghujung zaman Sultan Mohammad II. Moyangnya, Wan Sulaiman bin Wan Othman adalah menantu kepada Pak Wan Mahmud Menteri, Menteri Besar Kelantan zaman Sultan Mohammad I (1801-1836). Pak Wan Mahmud sendiri adalah cucu di sebelah ibunya kepada Engku Seri Maharaja Perdana Menteri Long Ghafar, salah seorang pengasas Kelantan yang terkenal itu. Di sebelah ayah Pak Wan Mahmud, Che Ibrahim adalah dari keturunan Tok Masjid Nakhoda Wangkang yang terkenal dalam sejarah Patani. Daripada keturunan aristokrat yang bercantum dengan keturunan ulama dan pejuang, lahirnya Dato' Perdana Nik Mahmud dalam tahun 1882.

Pendidikan

Ketika Nik Mahmud dilahirkan, Kota Bharu sedang berkembang sebagai pusat pengajian agama yang baru menggantikan Patani yang telah runtuh diserang Siam. Di sepanjang tebing sebelah timur Sungai Kelantan, dari Penambang hingga ke Pengkalan Leser (Kampung Sireh)

telah tumbuh surau-surau dan pondok sebagai pusat pengajian yang dikendalikan oleh para ulama. Di antara ulama yang terkenal mengajar di kawasan ini termasuklah Tok Guru Haji Awang Alim di Atas Paloh, Tok Guru Haji Abbas (Sungai Budor), Tok Guru Haji Nik Mat Dagu (Sungai Budor), Tuan Tabal (Tok Semian), Tok Konok (Padang Keluchor) dan Haji Ismail Qadhi sendiri di Atas Banggol. Ruang ini membuka peluang kepada Nik Mahmud belajar agama dengan meluas dan mendalam. Pada peringkat awal ini, sejak kanak-kanak beliau diajar sendiri oleh ayahnya di Surau Atas Banggol sehingga usianya remaja. Di antara rakan sepeguruan beliau di surau ini termasuklah Tok Kenali, Tok Jerulong, Tok Guru Haji Omar Mentuan dan lain-lain.

Selain menadahi ayahnya sendiri, dipercayai Nik Mahmud juga turut belajar dengan sahabat-sahabat ayahnya seperti Tok Guru Haji Abas Sungai Budor, Tual Tabal dan lain-lain. Ketika usianya mencecah 14 tahun, ayahnya menghantar beliau ke Patani untuk mempelajari agama dan juga ilmu persilatan. Guru-guru agamanya di Patani adalah tidak jelas, tetapi guru silatnya ialah Pak Yid Palembang dan Pak Sad. Setelah berada di Patani sekitar dua tahun, beliau dikejutkan dengan kematian ayahnya di Kota Bharu dalam bulan Ramadhan 1315. Beliau segera meninggalkan Patani dan balik ke Kota Bharu ketika usianya baru 16 tahun untuk mendapatkan ibunya. Dalam tahun itu juga, Nik Mahmud dan adik-adiknya dibawa naik ke Mekah oleh ibunya untuk diserahkan kepada Sheikh Wan Ahmad al-Fathani. Beliau mula belajar di Mekah sejak 1898 dengan beberapa orang guru termasuk Tok Wan Ali Kutan, Sheikh Nik Mat Kechik dan ramai lagi ulama Melayu yang lain, dengan Sheikh Wan Ahmad sebagai guru utamanya. Di sini beliau bertemu semula dengan Tok Kenali, murid ayahnya.

Bersama Sheikh Wan Ahmad al-Fathani, Nik Mahmud dikatakan telah diberikan pendidikan khusus berkait dengan ilmu siasah dan seni mempertahankan diri, kerana gurunya menganggap beliau telah alim dalam ilmu agama. Pada 1904, Nik Mahmud bersama Tok Kenali telah dibawa oleh Sheikh Wan Ahmad ke Beirut dan Kaherah dalam rehlah ilmunya sambil bermuzakarah dengan Sheikh Yusof an-Nabhani di Beirut dan Sheikh Mohammad Abduh di Mesir. Program lawatan sambal belajar ini telah mendedahkan beliau kepada pengalaman baru dalam ilmu dan juga politik. Setelah pulang dari lawatan ini, ibunya telah jatuh sakit di Mekah dan meninggal dunia di sana pada awal 1905. Nik Mahmud mengambil keputusan untuk membawa adik-adiknya balik ke Kelantan dalam tahun itu juga memandangkan ahli-ahli keluarga terdekatnya berada di Kelantan dan mereka pula masih berusia muda. Maka, Nik Mahmud pun menamatkan pengajian beliau selama enam tahun di Mekah dengan menguasai ilmu siasah dan pentadbiran, selain ilmu seni persilatan.

Pentadbir dan pemimpin politik

Setelah kembali ke Kelantan, Nik Mahmud telah dilantik sebagai kerani di Pejabat Tanah Kota Bharu pada 1907, iaitu ketika beliau berusia 25 tahun, sebelum dinaikkan pangkat sebagai kerani besar di Pejabat Balai Besar Negeri, iaitu pusat pentadbiran kerajaan setahun kemudian. Pada 1911, beliau dilantik pula sebagai Penolong Setiausaha Sulit Sultan Mohammad IV dan diberikan gelaran Dato' Bentara Setia mulai 22 Jun 1911. Pada pertengahan 1912, Menteri Besar Kelantan, Dato Menteri Che Hassan Mohd Salleh telah jatuh sakit, lalu Dato' Nik Mahmud telah dilantik sebagai Penolong Dato' Menteri mulai November 1912 dengan kuasa menjalankan tugas-tugas Dato' Menteri. Ketika beliau memangku tugas Dato' Menteri inilah berlakunya Perang Dunia Pertama yang menguji hubungan Kelantan-British yang baru terbentuk sejak 1910 itu, diikuti oleh peristiwa kebangkitan Tok Janggut pada 1915. Di antara langkah besar beliau menghadapi perubahan dasar pentadbiran oleh British di Kelantan ialah dengan menubuhkan MAIK pada akhir 1915.

MAIK yang ditubuhkan dengan dukungan Tok Kenali dan Dato' Laksamana Mohammad Mohd Said telah melakukan pembaharuan besar dalam urusan pentadbiran agama,

pendidikan Islam, penerbitan, percetakan dan lain-lain. Apabila Dato' Menteri Che Hassan meninggal dunia pada 22 Januari 1921, Dato' Nik Mahmud telah dilantik sebagai Menteri Besar Kelantan bergelar Dato' Perdana Menteri mulai 29 April 1921. Beliau kemudian diberi gelaran Dato' Seri Paduka Raja Mahkota Kelantan, lalu dikenali sebagai Dato' Perdana Menteri Paduka Raja. Beliau terus kekal sebagai pentadbir utama kerajaan dengan jawatan Menteri Besar itu sehingga tercetusnya Perang Dunia Kedua di Kelantan pada Disember 1941. Pada awal 1942, beliau telah bercuti dari jawatannya, dan tugasnya dipangku oleh anaknya, Dato' Nik Ahmad Kamil Nik Mahmud. Pada Ogos 1943, Jepun telah menyerahkan Kelantan kepada Siam, tetapi Dato' Perdana telah mengambil keputusan bersara, lalu melepaskan jawatannya secara rasmi mulai 27 Disember 1944.

Setelah bersara dari jawatan pentadbiran, Dato' Perdana telah meminggirkan dirinya daripada aktiviti politik, termasuk pergerakan menuntut kemerdekaan ketika itu. Beliau lebih banyak menghabiskan masa tuanya dengan kegiatan sosial, terutamanya bergiat dalam seni mempertahankan diri dan menulis buku-buku agama. Beliau dikatakan sangat kecewa dan sedih apabila berbangkit isu tentang bukunya, *Ringkasan Cetera Kelantan* yang diterbitkan pada 1934, lalu beliau tidak mahu lagi terlibat dalam politik dan pentadbiran negeri. Dalam tempoh persaraan ini, beliau telah menghasil tiga buah buku agama iaitu *Kitab Perbendaharaan Mastika* (1946), *Tajuk Kemuliaan* (1946) dan *Kitab Pati Rahsia* (1948). Selain itu, beliau juga sibuk menyusun salasilah keturunan Tengku, Nik dan Wan yang mendominasi politik Kelantan sejak pertengahan abad ke-19.⁶⁶ Sejak awal 1950-an juga, Dato' Perdana telah mengembangkan seni silat yang dipelajarinya di Kota Bharu dengan Tamam Indera Muda, iaitu Seni Silat Terlak Empat yang berasal dari Parsi. Rumahannya telah menjadi pusat kegiatan silat ini.

Menemui Ilahi

Sepanjang hidupnya, Dato' Perdana mempunyai tiga isteri iaitu Che Aisyah Dato' Seri Mohd Said, iaitu kakak kepada Dato' Laksamana. Dua lagi isteri beliau ialah Nik Mariam Tengku Ishak dan Wan Tik Kamariah Wan Ali. Dato' Perdana melalui tiga perkahwinan ini telah dikurniakan tujuh orang anak termasuk Tan Sri Nik Ahmad Kamil, bekas Yang Dipertua Dewan Rakyat dan Tan Sri Nik Mustapha Fadhil, bekas Dato' Maharajalela Istana Negara. Anak-anak beliau yang lain ialah Nik Hassan, Nik Zainab, Nik Rahimah, Wan Azizah dan Wan Ismail Murtadha. Setelah meninggalkan kehidupan politik sejak awal 1945 dan menghabiskan masa menulis, mengkaji dan meluaskan kegiatan seni silatnya, akhirnya Dato' Perdana telah jatuh sakit kerana berusia tua. Pada usia 82 tahun, Dato' Perdana Nik Mahmud telah menghembuskan nafas terakhirnya di rumahnya, di Jalan Atas Banggol pada 16 Ogos 1964. Jenazahnya dikebumikan di Tanah Perkuburan Banggol dengan penghormatan yang sesuai dengan jasanya kepada agama, bangsa dan negara.

PENYULUH KETINGGIAN: KARYA POLITIK DATO' PERDANA

Penyuluh Ketinggian adalah sebuah kitab karangan Dato' Perdana Nik Mahmud yang telah disiapkan pada 1935 yang kemudiannya dihadiahkan kepada Pejabat Pelajaran Kerajaan Kelantan sebagai bahan bacaan dan rujukan kepada para pelajar, orang muda dan masyarakat

⁶⁶ Manuskrip salasilah Tengku, Nik dan Wan yang berwujud 25 helaian kertas yang mencatatkan salasilah enam keluarga besar ini telah diperolehi oleh Datuk Nik Mohamed Moh Salleh, bekas Timbalan Presiden Persatuan Sejarah Malaysia (PSM) dan kemudiannya diselenggara dan diterbitkan oleh Nik Abdul Rahman Mustapha pada 2020. Menurut catatan Dato' Nik Mohamed, manuskrip tulisan Dato' Perdana ini diusahakan sejak 1920-an dan dibuat empat salinan, termasuk salinan Haji Nik Daud. Salinan Haji Nik Daud disimpan oleh anaknya, Haji Nik Ishak Kampung Tikat. Dato' Nik Mohamed memperolehi manuskrip ini dari simpanan Haji Nik Ishak Daud.

awam amnya. Buku ini telah dihasilkan dengan bantuan Tengku Mustafa Tengku Ali Aceh. Ia menjadi salah karya penting Dato' Perdana Nik Mahmud yang dihasilkan ketika beliau menjadi Perdana Menteri Kelantan, tetapi malangnya buku ini tidak pernah dicatatkan oleh mana-mana pengkaji yang mengkaji tentang biografi dan sumbangan Dato' Perdana Nik Mahmud sebelum ini. Karya-karya beliau yang sering disebutkan ialah *Kitab Geografi dan Tarikh Negeri Kelantan* (1926) dan *Ringkasan Cetera Kelantan* (1934) sebagai kitab sejarah, manakala *Kitab Cahaya Pertama* (1918), *Kitab Perbendaharaan Mastika* (1946), *Tajuk Kemuliaan* (1946) dan *Kitab Pati Rahsia* (1948) sebagai kitab-kitab agama yang disebut dalam kajian-kajian sebelum ini.

Walaupun buku *Penyuluh Ketinggian* ini telah siap ditulis pada penghujung 1935, tetapi ia tidak diterbitkan oleh Pejabat Pelajaran Negeri Kelantan, sebaliknya ia diterbitkan dalam *The Malay Home Library Series*. Penerbitan ini diselenggara oleh Pengetua Sultan Idris Training College (SITC), O.T Dussek sebagai *General Editor* dalam tahun 1936. *The Malay Home Library Series* merupakan penerbitan yang dikeluarkan oleh Pejabat Karang-Mengarang SITC, Tanjung Malim. *Buku Penyuluh Ketinggian* ini merupakan siri ke-40 daripada kumpulan siri penerbitan ini. Buku ini dicetak atau dicap oleh Gudang Printers Limited, Singapura dengan mengekalkan kandungan dan bentuk asal, termasuk lenggok bahasa Arab yang ditulis oleh Dato' Perdana, kecuali pada ejaan beberapa perkataan yang diselaraskan dengan ejaan semasa. Pada asasnya buku ini mengandungi isi setebal 253 muka surat dengan saiz 17.8 cm x 12.4 cm dan berkulit keras. Bentuk bukunya adalah sama seperti buku-buku tulisan Abdul Hadi Hassan tentang Sejarah Alam Melayu⁶⁷ yang diterbitkan oleh SITC ketika itu.

Buku *Penyuluh Ketinggian* ini mengandungi 55 tajuk yang membahaskan pelbagai aspek tentang kewajipan hidup manusia meliputi kewajipan para penuntut (pelajar), guru, hakim, penggawa, tentera, ahli perniagaan, petani, tukang, wartawan, pengarang hinggalah kepada para menteri dan raja. Penulis juga turut membahaskan tentang kewajipan yang terbeban ke atas individu sama ada ke atas dirinya sendiri, isteri, anak-anak, rumah tangga, keluarga, jiran, taulan, hamba dan juga musuhnya. Perbincangan tentang tanggungjawab dan kewajipan ini diperpanjangkan kepada persekitaran yang melibatkan seluruh manusia, binatang, tanah air hingga kepada Allah SWT sebagai Tuhan sekalian alam. Pada bahagian akhir buku ini, penulis telah memperkemas lagi persoalan kewajipan ini dengan menggariskan peraturan dan adab-adab bagi setiap manusia di dalam pergaulannya, sama ada melibatkan percakapan, perjumpaan, penulisan, bermusafir, berjamu, berjual beli dan juga berpakaian.

Pada umumnya, persoalan yang dibangkitkan oleh Dato' Perdana ini adalah pandangan balas terhadap tuntutan hak yang dipelopori oleh masyarakat Barat dan sedang diperkembangkan dalam pemikiran masyarakat Asia yang terjajah ketika itu. Isu-isu hak asasi manusia yang telah dibangkitkan oleh para pemikir Barat telah dikembangkan secara sempit iaitu dengan mempromosikan hak-hak individu yang meliputi hak sivil dan hak politik, sehingga mereka membelakangkan hak-hak masyarakat yang meliputi hak ekonomi, hak sosial dan hak budaya. Kemuncak kepada perjuangan masyarakat Eropah ini ialah berlakunya Deklarasi Hak Asasi Manusia 1948. Dari sudut pandangan Islam yang didukung oleh Dato' Perdana, persoalan hak ini perlu mempunyai imbalan dengan tanggungjawab, dan ia tidak terhenti pada persoalan hak individu semata-mata, sebaliknya ia mesti berkembang secara

⁶⁷ Abdul Hadi Hassan, 1925. *Sejarah Alam Melayu*, Penggal I. Pejabat Karang-Mengarang Jabatan Pelajaran Persekutuan Tanah Melayu, Kuala Lumpur.

seimbang dengan hak masyarakat. Islam telah mengambil jalan tengah dalam hal ini dengan tidak memberati salah satu daripada hak tersebut, sebaliknya menerimanya secara seimbang.

“Bahawa tiap-tiap manusia yang tiada menunaikan barang yang wajib (kewajipan) dan tiada mengerjakan barang yang dituntut atasnya, maka sesungguhnya [d]ia membawa dirinya kepada jalan-jalan yang mudharat dan kehinaan yang boleh ditimpa atas dirinya oleh bala kebencian...”⁶⁸ Demikian komentar Dato’ Perdana terhadap kegagalan manusia melaksanakan tanggungjawab dan lebih mementing hak sendiri sahaja. Jika diperhatikan daripada kandungan buku ini, ia boleh menggambarkan reaksi Dato’ Perdana tentang perkembangan politik dunia yang berlaku selepas Perang Dunia Pertama dan selepas kejatuhan Khilafah Othmaniyah pada 1924. Reaksi ini adalah ekoran penularan pemikiran sekular dan gerakan hak asasi manusia yang sedang merombak kehidupan beragama di kalangan masyarakat Islam, termasuk soal pengabaian tanggungjawab. Beliau cuba menjelaskan kepada generasi baru orang Melayu Islam tentang tanggungjawab dan adab-adab pergaulan yang disifatkan sebagai ‘penyuluh ketinggian’ bagi budi dan budaya.

Sepintas lalu buku ini adalah bersifat seperti buku tatarakyat atau menurut Tengku Mahmood Mahyiddeen seperti buku panduan pengakap yang ditulis oleh Lord Robert Baden-Powell yang bertajuk *Rovering to Success*⁶⁹ untuk memberikan latihan moral kepada ahli-ahli pengakap.⁷⁰ Walau bagaimanapun, jika diteliti mesej yang disampaikan, buku ini adalah sebuah buku politik Islam yang bukan sahaja menangani masalah pemikiran hak asasi manusia aliran Barat, tetapi juga menjelaskan pemikiran-pemikiran Islam terhadap beberapa elemen politik yang berkaitan hak dan tanggungjawab. Perbincangan buku ini pada asasnya tidaklah berbentuk politik, tetapi ia bersifat panduan kepada individu, kumpulan-kumpulan masyarakat, pemimpin dan raja, seperti *mirrors for rulers* atau cerminan kepada raja-raja dalam pendekatan buku-buku politik klasik zaman Parsi, India dan Turki dahulu. Lewat cerminan inilah dibangkitkan sejumlah tanggungjawab yang sepatutnya disedari dan diamalkan oleh masyarakat dalam mewujudkan ketinggian budi dan kemuliaan diri.

PEMIKIRAN TENTANG TANGGUNGJAWAB POLITIK ORANG ISLAM

Sama ada Dato’ Perdana menulis buku *Penyuluh Ketinggian* sebagai satu reaksi terhadap perkembangan politik liberal di Eropah yang memperjuangkan hak-hak asasi manusia atau sebaliknya, buku ini telah mengungkapkan beberapa pemikiran beliau tentang konsep tanggungjawab dalam kehidupan orang Islam, termasuk tanggungjawab politik. Ketika dunia begitu lantang menyuarakan persoalan kebebasan individu sebagai hak politik, sehingga masyarakat barat mulai ‘mempertuhankan’ individualistik, Nik Mahmud (1936) sebagai tokoh agama dan ahli politik yang berjiwa timur telah mengambil jalan sebaliknya, iaitu mengungkapkan tentang persoalan tanggungjawab atau kewajipan dalam mempertahankan hak-hak masyarakat. Bahkan, Nik Mahmud dengan pendekatan Islam telah membahaskan hak individu dan hak masyarakat secara bersama, sehingga terpancar dengan jelas tentang tanggungjawab-tanggungjawab politik orang Islam dalam perbincangannya.

Pada umumnya, kewajipan politik ini boleh dibahagikan kepada dua bahagian. Bahagian pertama ialah tentang kewajipan rakyat terhadap pemimpin dan negara, dan bahagian yang kedua ialah tentang kewajipan pemimpin dan negara terhadap rakyat. Kewajipan-kewajipan rakyat itu pada hakikatnya adalah hak-hak pemimpin dan negara ke atas mereka,

⁶⁸ Nik Mahmud Ismail, 1936. *Penyuluh Ketinggian*, Pejabat Karang-Mengarang SITC, Tanjung Malim, hal. 1

⁶⁹ Robert Baden-Powell, 1922. *Rovering to Success*. Herbert Jenkins Limited, London.

⁷⁰ Lihat Tengku Mahyiddeen, 1936. *Pendahuluan*, dlm. Nik Mahmud Ismail, *Penyuluh Ketinggian*, hal. v

sedangkan kewajipan-kewajipan pemimpin dan negara adalah hak-hak rakyat ke atas mereka. Perkara ini telah diberikan penekanan oleh Islam melalui hadis tentang *mas'uliyah* atau pertanggungjawaban, di mana setiap orang dianggap sebagai pemimpin oleh Islam menurut kadar masing-masing, dan mereka akan dipertanggungjawabkan tentang kepemimpinan mereka kelak. Hal ini diperkukuhkan lagi dengan penjelasan al-Quran bahawa manusia diperintahkan oleh Allah supaya melaksanakan tanggungjawab untuk mengangkat pemimpin yang terbaik, kemudian Allah menjelaskan tanggungjawab pemimpin untuk memerintah dengan adil. Bagi pemimpin yang memerintah dengan adil, maka menjadi tanggungjawab kepada rakyat untuk memberikan ketaatan.

Asas-asas ini menunjukkan tanggungjawab politik adalah terbahagi kepada dua bahagian. Dato' Perdana yang menggalurkan pelbagai tanggungjawab dalam kehidupan manusia, telah menjelaskan bahawa dalam konteks politik, pada kedua-dua bahagian ini, umat Islam mempunyai tanggungjawab yang mesti dilaksanakan bagi memastikan mereka mencapai manfaat dalam kehidupan. Bahkan, dengan melaksanakan kewajipan yang berbagai-bagai ini, sama ada kepada Allah, kepada raja, kepada tanah air (watan), kepada bangsa dan lain-lain, ia akan menjamin kemuliaan hidup seseorang (Nik Mahmud, 1936: 10). Di pihak pemerintah pula, Nik Mahmud (1936: 77) mengatakan bahawa mereka mendapat kemuliaan dengan pangkat dan kedudukan, lalu daripada mereka terbitnya segala hukuman dan undang-undang, pejabat-pejabat yang mentadbir rakyat dan segala alat keperluan rakyat. Kerana itu, pihak pemerintah mesti sentiasa bergaul dan bermesyuarat dengan segala pembesar (menteri) bagi membincangkan urusan rakyat (Nik Mahmud, 1936: 78). Di samping, di antara kedua-dua mereka, wujud pula tanggungjawab bersama terhadap negara.

Tanggungjawab Rakyat

Dalam konteks tanggungjawab rakyat, Dato' Perdana telah memulakan bicaranya dengan menyebut tentang ikrar dan perjanjian atau *bai'ah yang membentuk kontrak sosial* (disebut sebagai ikatan setiawan) di antara rakyat. Kontrak sosial ini dibina oleh rakyat sebagai satu kewajipan menyeluruh melibatkan hak-hak Allah, raja, negara dan bangsa. Melalui kontrak (*bai'ah*) ini, rakyat mengambil tanggungjawab untuk menolong di antara satu sama lain berdasarkan undang-undang dengan 10 prinsip iaitu mengakui kebenaran sebagai asas kemuliaan, ikhlas (bersih niat) terhadap raja dan pembesar, melakukan kebajikan, menjadi taulan kepada semua manusia tanpa mengira bangsa dan darjat, menjaga akhlak, kasihan belas kepada makhluk Allah, taat kepada perintah yang diberikan, bermanis muka, cermat dan bermoral mengikut peraturan adab (Nik Mahmud, 1936: 10-11). Daripada kontrak sosial yang terbentuk di antara rakyat dengan pemerintah inilah melahirkan kestabilan politik.

Dato' Perdana walau bagaimanapun tidak memperkatakan secara khusus tentang kewajipan untuk memilih orang yang terbaik sebagai pemimpin, walaupun persoalan mengangkat pemimpin dan ciri-ciri pemimpin yang layak diangkat telah digariskan oleh ulama-ulama dalam kitab fikah Islam, seperti yang disebut oleh al-Mawardi dan Ibnu Taimiyah dan lain-lain. Di antara faktor yang menyebabkan persoalan ini tidak diperkatakan adalah kerana realiti politik di Tanah Melayu, termasuk di Kelantan ketika itu masih lagi mengamalkan politik monarki mutlak, di mana takhta raja adalah diwarisi. Dalam dalam konteks ini, raja disenaraikan sebagai satu institusi yang mesti diberikan kesetiaan, selain watan dan bangsa (Nik Mahmud, 1936: 84). Konsep pemimpin yang dipilih secara langsung oleh rakyat hanya berlaku selepas Perang Dunia Kedua, apabila British memperkenalkan politik demokrasi di negara ini. Maka, kewajipan yang diperkatakan dalam konteks ini adalah dengan memberi *bai'ah* raja, negara (watan) dan bangsa.

Selain *bai'ah* atau perjanjian yang membentuk ikatan umum di antara rakyat dan pemerintah, Dato' Perdana secara khusus menyebutkan **tanggungjawab rakyat mengikut kelompok atau bidang kegiatan masing-masing dalam memajukan negara**. Beberapa kumpulan rakyat yang disinggung oleh beliau termasuklah para peguam yang dianggap bertanggungjawab dalam profesyennya untuk menzahirkan kebenaran, menolong orang yang dizalimi dan menolak kebatilan (Nik Mahmud, 1936: 16); guru yang bertanggungjawab mendidik generasi baru (Nik Mahmud, 1936: 12-13); tentera yang wajib memberikan kesetiaan kepada negara, termasuk menggadai nyawanya (Nik Mahmud, 1936: 29); ahli perniagaan yang bertanggungjawab untuk mencipta keuntungan dalam perniagaan dengan menguasai kemahiran berniaga kerana ia akan membantu ekonomi negara (Nik Mahmud, 1936: 35); dan petani yang mempunyai tanggungjawab mengambil hasil dari kesuburan bumi untuk kemakmuran negara (Nik Mahmud, 1936: 43).

Di antara golongan yang penting dalam masyarakat ialah wartawan dan pengarang, kerana tulisan-tulisan mereka sangat mempengaruhi pemikiran rakyat. Nik Mahmud (1936: 65) menjelaskan bahawa ahli surat khabar atau wartawan mempunyai tanggungjawab sebagai 'lidah umat' yang menjadi lambang bagi ketinggian budaya sesebuah kaum. Akhbar berperanan untuk menyebarkan pemikiran, baik atau buruk sehingga ia menjadi cerminan terhadap pemikiran masyarakat. Akhbar juga menzahirkan pemikir-pemikir dalam masyarakat, sehingga ia menjadi saluran untuk kebebasan akal. Kerana itu, wartawan bertanggungjawab untuk sentiasa benar, tetap dan merdeka fikirannya serta pada segala tulisan dan nasihatnya (Nik Mahmud, 1936: 67). Demikian juga para pengarang yang menghasilkan pelbagai tulisan sama ada buku, novel, cerpen, puisi dan lain-lain yang sentiasa membawa mesej politik, maka wajib mereka mengarang untuk meninggikan kemuliaan manusia (Nik Mahmud, 1936: 71).

Ahli-ahli pertukangan pula bertanggungjawab menguasai kemahiran dalam pelbagai bidang pertukangan sehingga dapat menguasai daratan dan lautan dalam mewujudkan kemakmuran di atas muka bumi (Nik Mahmud, 1936: 49-50); serta ibu bapa yang berkewajipan dalam mendidik anak-anak, menjaga keutuhan rumah tangga, menjaga hubungan kekeluargaan, kejiranan dan pergaulan (Nik Mahmud, 1936: 97-151). Peranan ibu bapa sebagai nukleus masyarakat sangat penting untuk mewujudkan keamanan, kestabilan dan kemakmuran negara. Nik Mahmud (1936: 166) turut menjelaskan bahawa manusia pada hakikatnya saling bergantung di antara satu sama lain, seperti susunan batu-bata dalam binaan sebuah bangunan, maka menjadi tanggungjawab setiap manusia untuk membantu golongan yang lemah, termasuk fakir miskin dengan sentiasa menghulurkan bantuan, dan juga bertanggungjawab untuk membela makhluk-makhluk Allah yang lain seperti binatang, tumbuhan dan alam sekitar (Nik Mahmud, 1936: 152).

Selain tanggungjawab untuk memberikan kesetiaan melalui *bai'ah* dan menjalankan peranan masing-masing dalam memaju dan memakmurkan negara, rakyat mempunyai satu lagi tanggungjawab yang besar iaitu memberikan **ketaatan kepada raja dan negara**. "Apabila kamu di bawah perintah, maka hendaklah kamu taat kepada ketua-ketua kamu itu serta hormatkan dia..." (Nik Mahmud, 1936: 60). Konsep mentaati ketua, pemimpin, raja dan negara sebenarnya wujud ketika mana pemerintah atau raja memerintahkan dengan apa yang diperintah oleh Allah atau selaras dengan hukum syarak, yang mana Nik Mahmud (1936: 85-87) telah memberikan penekanan yang kuat bahawa raja yang memerintah mestikan menjaga kemuliaan agama, menjalankan syariat Allah dan menegakkan keadilan. Nik Mahmud (1936: 95) juga menjelaskan kewajipan seseorang itu untuk menjauhkan diri dari seseorang yang lain, termasuk pemimpin apabila dia berbuat perbuatan tercela mengikut hukum syarak.

Satu lagi tanggungjawab yang ditekankan oleh Dato' Perdana ialah kewajipan diri atau individu ke atas diri masing-masing, terutama dalam mengekalkan kehormatan, kemegahan, kelebihan dan sebagainya. Kewajipan ini terbahagi kepada tiga perkara, iaitu kewajipan memelihara survival hidup di mana mereka bersungguh-sungguh memajukan diri dalam segala

aspek pekerjaan dan mengelakkan kemalasan; kedua, kewajipan menjaga kesihatan dengan menjaga makan, riadah dan aturan kesihatan yang lain; dan ketiga, kewajipan bertingkah-laku yang baik melalui penyuburan akal dan mengetahui keupayaan diri. Setiap individu berkewajipan untuk memelihara kebajikan dan menolak segala kemudharatan dalam kehidupan, serta wajib pula setiap orang melawan kehendak hawa nafsunya sendiri dalam melakukan kejahatan. Setiap orang juga wajib memastikan dirinya berjalan di atas jalan yang membentuk kemuliaan dirinya (Nik Mahmud, 1936: 89-95). Hal ini semua adalah untuk memberi faedah dan manfaat dalam menguatkan bangsa.

Tanggungjawab Pemimpin dan Negara

Dalam memperkatakan tentang tanggungjawab politik bagi pemimpin dan negara, Nik Mahmud (1936) telah membahagikan kelompok pemimpin kepada tiga peringkat, iaitu raja, pemimpin besar dan pemimpin bawahan. Raja adalah pemimpin tertinggi bagi negara dan kerajaan, seperti mana tradisi politik orang Melayu yang meletakkan raja sebagai pemimpin tertinggi mereka. Pada lapisan kedua, pemimpin besar iaitu pentadbir atau pegawai utama negeri, bermula dari Menteri Besar, ahli majlis mesyuarat kerajaan dan juga para hakim dan qadhi, sedangkan para pemimpin seperti penggawa, ketua kampung dan seumpamanya boleh dianggap sebagai pemimpin bawahan. Dalam konteks pentadbiran kerajaan, ketiga-tiga elemen kepemimpinan ini biasa dianggap sebagai mewakili 'negara' atau 'state.' Mereka bertanggungjawab mentadbir negara dengan melaksanakan semua kewajipan dalam melayani hak-hak rakyat setelah diberi mandat melalui *bai'ah*, sehingga berkewajipan pula rakyat mentaati mereka.

Raja sebagai pemimpin tertinggi negara digariskan oleh Nik Mahmud (1936: 84-88) sebagai mempunyai sekurang-kurangnya 10 kewajipan asasi, iaitu:

- i. Memelihara kehormatan agama Islam, termasuk memelihara kemuliaan diri sebagai raja dengan menjauhkan diri daripada segala pekerjaan yang jahat dan pergaulan dengan orang yang fasik. Berlemah-lembut, kurang bercakap, kasih kepada rakyat, sehingga boleh memberi manfaat dan memajukan rakyat;
- ii. Memiliki sifat-sifat kecerdikan, berhemah, bercita-cita tinggi, halus pentadbirannya dan tinggi siasatnya;
- iii. Memelihara keselamatan tanah air (watan) dan kerajaan sehingga sanggup mempertahankannya daripada musuh dengan harta dan nyawa. Mesti melaksanakan syariat Islam dalam pemerintahan untuk menghapuskan keleluasaan hawa nafsu, melaksanakan amar makruf dan nahi mungkar, serta mendamai pihak-pihak yang berselisih dalam negara;
- iv. Meluaskan kerajaan melalui pelaksanaan undang-undang, amalan bermesyuarat, mengambil iktibar daripada orang terdahulu dan para pembesar negeri (menteri), tidak tergopoh-gapah mengambil keputusan sebelum berbincang dengan menteri, membanyak sedekah dan becermat dalam berbelanja;
- v. Berusaha meningkatkan ekonomi negeri melalui perniagaan, pertukangan, pertanian, perusahaan, sehingga orang-orang kaya dapat menjalankan kegiatan ekonomi dan orang-orang miskin mendapat pekerjaan;
- vi. Mengambil berat tentang perkembangan yang berlaku dalam dan luar negeri dari semua aspek, politik, ekonomi dan sosial, termasuk mengambil tahu tingkah laku para pembesar sehingga dapat diuruskan dengan adil, serta memerintah rakyat berdasarkan undang-undang;
- vii. Menyedari bahawa terpilihnya raja sebagai pemerintah adalah atas kehendak Allah dengan tujuan untuk menjaga, menaungi dan menjalankan keadilan, maka hendaklah melaksanakan dasar, undang-undang dan hukum yang diredhai oleh Allah;

- viii. Bersungguh-sungguh untuk mendatangkan kesenangan dan kemegahan untuk rakyat dengan ikhlas dan penuh amanah, tanpa melalaikan diri daripada tanggungjawab ini;
- ix. Berjinak-jinaklah dengan ulama dan orang yang berilmu tinggi tentang ilmu pemerintahan negeri; dan
- x. Berusaha meninggikan hikmah kebenaran dan menghargai orang-orang yang rajin dan berjasa dalam negeri.

Adapun bagi para pembesar utama negeri, Nik Mahmud (1936: 80-83) telah menggariskan beberapa tanggungjawab mereka terhadap negara dan rakyat, iaitu i) wajib memperbaiki keadaan politik (siasah) melalui hemah yang besar, kecerdikan dalam percaturan politik dan fikiran yang tajam supaya dapat memuaskan hati raja dan rakyat; ii) menangani akhlak raja-raja dengan bijaksana; iii) mementingkan kemuliaan diri dan tidak terlibat dengan politik adu-domba; iv) sentiasa mengajak rakyat kepada kesentosaan dan keamanan serta memperbaiki kelemahan kerajaan yang ada; v) bergaul dengan ulama dan hukama' untuk mengambil manfaat daripada mereka; vi) berkhidmat kepada negara dengan amanah dan ikhlas; vii) menjadikan diri sebagai tangan kanan raja dalam membangunkan negara; dan viii) bergerak di atas jalan yang benar dalam mentadbir negara. Dengan terlaksananya semua tanggungjawab ini bagi seorang pembesar utama negeri, maka sebuah kerajaan yang telus dan berwibawa dapat dibentuk.

Di luar daripada pejabat penguasa atau eksekutif, pemimpin besar dalam bidang judikatif seperti hakim dan qadhi juga mempunyai tanggungjawab politik menurut Nik Mahmud (1936: 21-24). Di antara kewajipan hakim dan qadhi ialah mengelakkan diri daripada menerima rasuah, menghukum dengan adil, mempunyai cita-cita untuk menegakkan keadilan, menghimpunkan di antara adil dan kasih sayang dalam menjatuhkan hukum dan memahami bahawa berlaku tidak adil dalam menghukum akan menyebabkan dirinya jatuh ke neraka. Di peringkat terbawah, ketua-ketua daerah (penggawa) dan ketua kampung (penghulu) juga dibebankan dengan tanggungjawab politik, di antaranya menjalankan undang-undang, memenuhi keperluan rakyat di daerahnya, melindungi rakyat daripada keburukan, melaksanakan amar makruf nahi mungkar, melengkapkan diri dengan ilmu, ikhlas dalam melaksanakan tanggungjawab dan taat kepada kerajaan yang menyerahkan amanah kepadanya (Nik Mahmud, 1936: 26-28).

Walaupun para pembesar utama, hakim dan qadhi serta penggawa dan penghulu telah mempunyai kewajipan masing-masing dalam konteks pemerintahan negara hubungan dengan rakyat, namun seluruh tanggungjawab terhadap negara dan rakyat ini pada hakikat telah terbeban di atas bahu raja. Adapun para pembesar, hakim dan penggawa adalah orang-orang yang diberikan amanah untuk melaksanakan tanggungjawab politik bagi pihak raja. Atas dasar itu, Nik Mahmud (1936), setiap kali menyebut tentang tanggungjawab mereka, akan digariskan sifat-sifat dan amalan yang perlu dilakukan bagi mewujudkan sifat bertanggungjawab tersebut. Apabila diperhatikan senarai tanggungjawab seorang ketua negara atau raja, ia menggambarkan satu tanggungjawab yang besar dan menyeluruh yang dipikul oleh raja, sebelum pengagihan kuasa dilakukan kepada para pembesar, hakim dan juga penggawa, sehingga hak-hak rakyat dapat diperturunkan dengan berkesan.

Tanggungjawab Bersama

Di sebalik sejumlah tanggungjawab politik yang dibebankan kepada rakyat, dan sejumlah lain yang dibebankan kepada kerajaan atau pemerintah, terdapat beberapa tanggungjawab politik yang menjadi tanggungjawab bersama. Pertama, tanggungjawab untuk mempertahankan kedaulatan negara. Raja sebagai pemerintah mempunyai tanggungjawab untuk memelihara keselamatan watan sehingga sanggup mempertahankannya daripada dirampas oleh musuh

dengan harta dan nyawanya (Nik Mahmud, 1936: 85), dalam maksud kerajaan, raja dan pemimpin adalah mempunyai kewajipan untuk mempertaruhkan nyawa mereka demi mempertahankan kedaulatan negara dari ancaman musuh. Demikian rakyat secara keseluruhannya turut terbeban dengan kewajipan yang sama, iaitu untuk memberikan kesetiaan dan mempertahankan negara (Nik Mahmud, 1936: 156). Secara khusus, rakyat yang menjadi tentera adalah berkewajipan mempertahankan negara, termasuk menggadai nyawanya (Nik Mahmud, 1936: 29).

Kedua, tanggungjawab membangunkan negara adalah terbeban kepada pemerintah, di mana raja atau pemimpin perlu mengambil langkah-langkah untuk memajukan negara dari sudut pembangunan ekonomi, termasuk perniagaan, pertukangan, pertanian, perusahaan dan lain-lain, sebagai usaha untuk meningkatkan pendapatan negara, membawa kemajuan kepada rakyat dan memakmurkan negara. Nik Mahmud (1936: 86) menegaskan bahawa kerajaan bertanggungjawab menggalakkan rakyat atau orang kaya untuk terlibat dalam pembangunan, terutama perniagaan bagi membolehkan orang-orang miskin mendapat peluang pekerjaan. Sedangkan bagi pihak rakyat, Nik Mahmud (1936: 159) mengatakan rakyat perlu terlibat dan bertanggungjawab untuk menghidupkan pelbagai sektor ekonomi termasuk pertanian, perniagaan, pertukangan dan lain-lain, termasuk mengambil upah dalam pelbagai sektor seperti perguruan, persuratkhabaran, ketenteraan dan sebagainya.

Di samping itu pula, Nik Mahmud (1936: 82 dan 88) telah menegaskan bahawa raja dan pemimpin mesti mewujudkan budaya ilmu dengan bergaul dan mengambil para ulama dan orang cerdik pandai sebagai penasihat mereka secara khusus, yang menunjukkan bahawa sekelompok rakyat adalah berperanan menjadi penasihat kepada kerajaan, termasuk para pembesar juga yang boleh menasihati raja dengan fikiran-fikiran yang baik dan tajam untuk membantu raja mentadbir negara (Nik Mahmud, 1936: 80). Ke atas rakyat pula, kerajaan juga berperanan untuk menasihati, menggalak dan mendorong rakyatnya supaya berbuat yang makruf dan meninggalkan kemungkaran, menggalakkan rakyat supaya rajin berusaha untuk membangunkan diri dan keluarga sekaligus ekonomi negara serta mendorong rakyat terus belajar, mendalami ilmu yang pelbagai, mendampingi ulama dan menghormati guru-guru. Dalam hal ini, ternyata kerajaan dan rakyat mempunyai tanggungjawab yang seimbang dalam nasihat-menasihati.

Proses nasihat-menasihati ini menunjukkan bahawa kedua-dua pihak juga mempunyai tanggungjawab bersama dalam membangunkan akal yang sihat. Selain bergaul dan mendapat nasihat daripada ulama, Nik Mahmud (1936) berulang kali menyebut tanggungjawab kerajaan untuk memastikan hal-hal yang merosakkan akal rakyat seperti meminum arak hendaklah disekat oleh kerajaan daripada berkembang dalam masyarakat. Dalam masa yang sama, Nik Mahmud (1936: 4-7 dan 12-15) menekankan peranan para guru dan tanggungjawab pelajar dalam membangunkan minda mereka. Di antara golongan rakyat yang mendapat perhatian Nik Mahmud (1936: 65-71) ialah wartawan dan pengarang, yang menurut beliau sangat berperanan untuk melahirkan kebebasan bersuara dan berpendapat. Jika kebebasan ini tidak diuruskan secara bertanggungjawab ia boleh mendatangkan mudharat, tetapi jika ia dilaksanakan secara bertanggungjawab, ia akan membantu memajukan pemikiran masyarakat.

Nik Mahmud (1936) ketika membahaskan tentang ketinggian, kemuliaan dan kemegahan orang Islam, telah meletakkan kesedaran terhadap tanggungjawab ini secara menyeluruh dalam pelbagai aspek. Tetapi secara politiknya, Nik Mahmud (1936) telah menyentuh tanggungjawab ini dalam pelbagai sudut, yang boleh dikategorikan dalam kelompok tanggungjawab, iaitu tanggungjawab rakyat kepada negara, tanggungjawab negara kepada rakyat dan tanggungjawab bersama kedua-dua pihak. Isu tanggungjawab yang dibangkitkan oleh Nik Mahmud (1936) untuk menjelaskan konsep ketinggian atau kemuliaan kehidupan telah menjawab sebahagian daripada pemikiran yang sangat mengutamakan kebebasan individu sehingga berlaku keciciran tanggungjawab dalam kehidupan

bermasyarakat. Pemikiran kebertanggungjawaban yang diketengahkan oleh Nik Mahmud ini menunjukkan bahawa Islam adalah agama yang tidak mengabaikan persoalan masyarakat dalam pemikiran hak asasi manusianya, di samping turut mempertahankan hak-hak individu dan hak-hak sivil.

PENUTUP

Dato' Nik Mahmud sebagai seorang ulama, pemimpin dan pemikir umat telah melontarkan mutiara-mutiara pemikirannya dalam membentuk akhlak dan sifat budiman di kalangan masyarakat Islam, khususnya generasi baru. Pengalaman beliau bergaul dengan para ulama dan berkecimpung dalam pentadbiran negeri sejak dekad pertama abad ke-20 telah membolehkan beliau merumuskan beberapa pandangan yang penting berkaitan dengan tanggungjawab pelbagai pihak dalam membentuk ketinggian peribadi dan budaya. Beliau telah menyentuh tanggungjawab raja, pembesar, hakim dan penggawa di kalangan pemimpin, dan juga tanggungjawab pelbagai golongan masyarakat terhadap negara. Persoalan yang dibangkitkan oleh beliau yang berupa panduan kepada pemimpin dan masyarakat merupakan satu garis panduan terhadap kewajipan politik yang mesti dilaksanakan oleh setiap orang Islam dalam kehidupannya, sesuai dengan konsep tanggungjawab sebagai beban kewajipan yang akan dipersoalkan oleh Allah kelak.

Dalam memperkatakan hal ini, Dato' Perdana telah membangkitkan tiga aspek tanggungjawab politik yang mesti dilaksanakan oleh umat Islam. Pertama, tanggungjawab setiap orang rakyat atau anggota masyarakat terhadap pemimpin dan negara; kedua, tanggungjawab yang mesti dilaksanakan oleh setiap lapisan pemimpin terhadap rakyat dan negara; dan ketiga, tanggungjawab bersama yang mesti dilakukan kedua-dua pihak dalam membentuk ketinggian dan kemuliaan hidup bermasyarakat dan bernegara. Pada asasnya, konsep tanggungjawab yang dikemukakan dalam pemikiran Dato' Perdana adalah menggambarkan pemikiran Islam yang menolak konsep perjuangan kebebasan individu secara melampau dan pengabaian terhadap masyarakat. Hak dan tanggungjawab diperkatakan secara seimbang, sekaligus menjadi hak-hak individu dan hak-hak masyarakat juga perlu dilaksanakan secara bersama. Untuk mendapat hak masing-masing, maka setiap pihak mesti melaksanakan tanggungjawab terhadap orang-orang yang berhak ke atasnya.

PENGHARGAAN

Penulis merakamkan setinggi-tinggi penghargaan kepada RMC UTM (Geran No: 19J92) dan KPT (Geran No: FRGS 1/2020/SS10/UTM/01/03) kerana menyediakan bantuan kewangan bagi kajian ini dijalankan.

RUJUKAN

- Abdul Hadi Awang, 1995. *Sistem Pemerintahan Negara Islam*. Kepala Batas, Dewan Muslimat Sdn. Bhd.
- Abdul Hadi Hasan, 1952. *Sejarah Alam Melayu*. Kuala Lumpur, Pejabat Karang-mengarang Jabatan Pelajaran Persekutuan Tanah Melayu.
- Dewan Bahasa dan Pustaka, 2002. *Kamus Dewan*, ed. 3, cet. Ke-7. Kuala Lumpur, Dewan Bahasa dan Pustaka.
- Ibnu Taimiyah, Taqiyuddin Ahmad, 1995. *Siayah Syar'iyah: Etika Politik Islam*, terj. Rofi' Munawwar. Surabaya, Penerbit Risalah Gusti.

- Ismail Che Daud, 2012. *Tokoh-tokoh Ulama' Semenanjung Melayu (1)*. Kota Bharu, Majlis Agama Islam dan Adat Istiadat Melayu Kelantan.
- Al-Mawardi, Abul Hassan Ali Muhammad al-Basri, 1973. *Al-Ahkam al-Sultaniyah*. Kaherah, Maktabah al-Babi al-Halabi.
- Mohd Fadli Ghani, 2022. *50 Tokoh Tersohor Kelantan Darul Naim*, Jld. 1. Kota Bharu, Perbadanan Muzium Negeri Kelantan.
- Nik Mahmud Ismail, 1936. *Penyuluh Ketinggian*. Tanjung Malim, Pejabat Karang-mengarang Sultan Idris Training College (SITC).
- Nik Abdul Rahman Mustapha, peny., 2020. *Salsilah Keluarga Tengku. Nik, Wan Berdasarkan Manuskrip Dato' Perdana Menteri Paduka Raja Nik Mahmud*. Batu Caves, Nik Abdul Rahman bin Mustapha.
ninanelsonbooks.com
ppn.kelantan.gov.my
- Robert Baden-Powell, 1922. *Rovering to Success*. Herbert Jenkins Limited, London.
- Wan Mohd Saghir Abdullah, 1999. *Penyebaran Islam & Silsilah Ulama Sejagat Dunia Melayu*, Siri 2. Kuala Lumpur, Khazanah Fathaniyah.
- Wan Mohd Saghir Abdullah, 1999. *Penyebaran Islam & Silsilah Ulama Sejagat Dunia Melayu*, Siri 3, Jld. 2. Kuala Lumpur, Khazanah Fathaniyah.
- Wan Z Kamaruddin Wan Ali dan Ahmad Zuhdi Ismail, 2009. *Konsep Kewajipan dan Tanggungjawab (al-Taklif) Dalam Pemikiran Islam: Penerapan dan Aplikasinya Dalam Kehidupan Masyarakat Muslim*. Researchgate.net.

Pemeriksaan Religiositi dalam Kalangan Mualaf di Darul Ukhuwah Johor Bahru

Ahmad Zaki Bin Mohamad Malom
University Tun Hussein Onn Malaysia
g1200002@siswa.uthm.edu.my

Intan Farhana Binti Saparudin
University Tun Hussein Onn Malaysia
intan@uthm.edu.my

Shakila Binti Ahmad
University Tun Hussein Onn Malaysia
shakila@uthm.edu.my

Mustapahayuddin Bin Abdul Khalim
University Tun Hussein Onn Malaysia
mustapa@uthm.edu.my

ABSTRACT

The education of faith, Sharia and morality in Islam is a branch of knowledge that must be understood and mastered by converts to become a true Muslim. These three branches of knowledge also symbolize the religiosity of a Muslim because it is the knowledge that explains the concept of Islam, faith and kindness in religion. However, the converts' understanding and practice of strengthening religiosity is still at a worrying level. This study aims to identify the need to measure the level of religiosity among converts at Darul Ukhuwah Johor Bahru. This writing uses library research methods and document analysis related to the study as well as interviews with preachers. The results of the study found that the level of religiosity among the converts is in an insufficient situation. Therefore, various parties need to pay attention and make improvements so that the success of the study of faith, Sharia and morals, especially in terms of the understanding of converts, can be achieved. In addition, the converts can also strengthen their confidence in Islamic beliefs.

ABSTRAK

Pengajian akidah, syariat dan akhlak dalam Islam adalah cabang ilmu yang perlu difahami dan dikuasai oleh para mualaf untuk menjadi Muslim sejati. Tiga cabang ilmu ini juga melambangkan religiositi seorang Muslim kerana ia merupakan ilmu yang menjelaskan konsep Islam, iman dan ihsan dalam agama. Namun begitu, kefahaman dan pengamalan para mualaf terhadap pengukuhan religiositi masih di tahap yang membimbangkan. Kajian ini bertujuan untuk mengenal pasti keperluan pengukuran tahap religiositi dalam kalangan mualaf di Darul Ukhuwah Johor Bahru. Penulisan ini menggunakan kaedah kajian perpustakaan dan analisis dokumen yang berkaitan dengan kajian serta temu bual kepada pendakwah. Hasil kajian mendapati bahawa, tahap religiositi dalam kalangan mualaf berada pada situasi yang tidak mencukupi. Justeru, pelbagai pihak perlu memberi perhatian dan membuat penambahbaikan supaya keberhasilan pengajian akidah, syariat dan akhlak terutamanya dari segi kefahaman mualaf dapat dicapai. Di samping itu, para mualaf juga dapat meneguhkan keyakinan terhadap pegangan Islam.

Kata Kunci: Religiositi, Mualaf, Darul Ukhuwah, Johor Bahru.

PENDAHULUAN

Darul Ukhuwah merupakan satu pusat pengajian bagi golongan muallaf yang diuruskan oleh Badan Kebajikan Saudara Kita di bawah pemantauan Jabatan Agama Islam Negeri Johor. Terdapat 10 buah daerah dalam negeri Johor dan setiap daerah mempunyai Badan Kebajikan Saudara Kita yang tersendiri dan dipengerusikan oleh individu muallaf yang telah berpengalaman. Badan Kebajikan Saudara Kita memainkan peranan untuk menguruskan kelancaran perjalanan kelas-kelas pengajian di Darul Ukhuwah mengikut kawasan daerah masing-masing. Selain menjadi pusat pengajian, Darul Ukhuwah juga menjadi tempat untuk Badan Kebajikan Saudara Kita mengagihkannya bantuan-bantuan yang disalurkan oleh Jabatan Agama Islam Negeri Johor kepada golongan muallaf yang memerlukan. Darul Ukhuwah akan memainkan peranan mengikut corak kreativiti pengurusan para pendakwah dan pengerusi Badan Kebajikan Saudara Kita di daerah masing-masing.

Setiap Badan Kebajikan Saudara Kita di dalam daerah negeri Johor mempunyai 2 orang pendakwah. Namun begitu, daerah Johor Bahru mempunyai bilangan pendakwah yang lebih ramai iaitu seramai 6 orang. Hal ini kerana, bilangan muallaf yang memeluk agama Islam di daerah Johor Bahru merupakan paling ramai berbanding daerah lain dalam negeri Johor. Sebagaimana dalam rekod pengislaman di Jabatan Agama Islam Negeri Johor sendiri membuktikan bilangan muallaf di daerah Johor Bahru pada tahun 2021 adalah seramai 451 orang. Daerah kedua teramai adalah Kulai dengan bilangan muallaf seramai 66 orang kemudian diikuti oleh daerah Kluang yang merekodkan pengislaman seramai 42 orang (Statistik Data Pengislaman Saudara Kita Bagi Daerah-Daerah Negeri Johor Darul Takzim, 2021). Jurang perbezaan bilangan muallaf yang memeluk agama Islam yang ketara ini menjadi bukti keperluan bilangan pendakwah yang lebih ramai di kawasan daerah Johor Bahru bagi memastikan kelancaran dan kebolehcapaian dalam pengurusan pembangunan muallaf.

Para pendakwah di Darul Ukhuwah merupakan individu muallaf yang telah melepasi had tempoh muallaf di Johor dan berpengalaman serta mampu memberi komitmen dalam pengurusan pembangunan muallaf. Mereka ini dilantik oleh Jabatan Agama Islam Negeri Johor dengan sokongan daripada pengerusi Badan Kebajikan Saudara Kita. Setiap Pendakwah diberikan elaun sebagai imbalan terhadap masa dan tenaga yang mereka luangkan demi membantu hal-hal pengurusan muallaf. Sebagai contoh, Puan Rusilah binti Abdullah merupakan pendakwah dan merangkap bendahari yang melaksanakan tugas-tugas pentadbiran di Darul Ukhuwah Johor Bahru merangkumi tugas penyampaian duit tambang kepada muallaf yang hadir ke kelas pengajian. Justeru para pendakwah inilah yang terlibat secara langsung dalam memainkan usaha memperkasakan tahap religiositi golongan muallaf di Johor Bahru.

MUALAF DAN RELIGIOSITI

Muallaf di dalam kamus Dewan bermaksud orang yang baru memeluk Islam atau saudara baru. (Kamus Dewan Edisi keempat, 2010). Majlis Agama Islam Negeri Johor pula menyatakan muallaf sebagai mereka yang hatinya baru berjinak-jinak dengan agama Islam dan mendapat hidayah menganuti Islam supaya mereka merasakan adanya tempat bergantung bagi menghadapi cabaran yang mendatang. Menurut al-Marbawi (1990), pengertian gelaran muallaf adalah gelaran bagi orang yang baru memeluk agama Islam. Perkataan muallaf ini berasal daripada perkataan *alifa*, *ya' lifu*, *ilfan*. *Alifahu* pula bermaksud menggemari atau menyukai atau berjinak-jinak. Manakala *allafa baynahum* pula bermaksud memperkasihkan di antara mereka. Dapat dilihat, Al-Quran ada menyebut secara khusus berkaitan muallaf di dalam surah al-Tawbah ayat 60 yang menggambarkan kelompok baru memeluk agama Islam.

﴿ إِنَّمَا الصَّدَقَتُ لِلْفُقَرَاءِ وَالْمَسْكِينِ وَالْعَمِلِينَ عَلَيْهَا وَالْمُؤَلَّفَةِ قُلُوبُهُمْ وَفِي الرِّقَابِ وَالْغُرَمِينَ وَفِي سَبِيلِ اللَّهِ وَالْبَنِ
السَّبِيلِ فَرِيضَةً مِّنَ اللَّهِ وَاللَّهُ عَلِيمٌ حَكِيمٌ ٦٠

Maksudnya: Sesungguhnya zakat itu hanyalah untuk orang-orang fakir, orang miskin, amil zakat, yang dilunakkan hatinya (mualaf), untuk (memerdekakan) hamba sahaya, untuk (membebaskan) orang yang berutang, untuk jalan Allah dan untuk orang yang sedang dalam perjalanan, sebagai kewajiban dari Allah. Allah Maha Mengetahui, Maha bijaksana.

(al-Tawbah: 60)

Ahmad Redzuwan Mohd Yunus dan Nur Kareelawati Abd Karim (2005), mentakrifkan istilah mualaf adalah kalangan manusia yang baru memeluk agama Islam dan berhak mendapat zakat dan pemberian tersebut bertujuan untuk melunakkan hati dan menguatkan keIslaman mereka. Mualaf juga dimaksudkan sebagai segolongan manusia yang kufur kemudian memeluk Islam dengan mengucapkan dua kalimah syahadah (Nur A'thiroh Masyaa'il Tan @ Tan Ai Pao, 2007).

Para ulama mazhab Syafie turut membuat perincian mengenai pentafsiran asnaf mualaf dengan menegaskan bahawa seseorang itu dianggap sebagai mualaf setelah ia menganut agama Islam sahaja. Berdasarkan pandangan dalam mazhab Syafie, mualaf ialah orang yang dijinakkan atau dilembutkan hatinya yang telah memeluk agama Islam (Al-Syafie, t.th). Hal ini selari dengan pentakrifan mualaf yang diberikan oleh Majlis Agama Islam Negeri Johor berdasarkan Jawatankuasa Fatwa Negeri Johor yang bersidang pada 11 Rabiul Akhir 1437 bersamaan 21 Januari 2016 telah membuat keputusan bahawa seseorang itu digelar sebagai mualaf apabila ia baru sahaja memeluk agama Islam dalam had tempoh selama 10 tahun. Sekiranya ia telah melepasi tempoh 10 tahun tersebut, maka individu tersebut telah terkeluar daripada takrifan mualaf dan dikira sebagai mukalaf. Tetapi bagi golongan orang asli yang baru memeluk agama Islam, mereka memiliki had tempoh sebagai mualaf sepanjang umur mereka. Hal ini dipengaruhi oleh perhatian dan keperluan bantuan serta sokongan yang perlu ditumpukan lebih kepada golongan orang asli berbanding masyarakat luar. Had tempoh yang ditetapkan adalah untuk memastikan sepanjang tempoh seseorang itu digelar sebagai mualaf, ia dapat mengakses bantuan-bantuan yang disediakan kepada mereka untuk memajukan diri dalam kehidupan beragama Islam (Zamri, 2020).

Kemajuan diri individu mualaf yang paling diutamakan adalah dari aspek religiositi mereka. Hal ini kerana, religiositi dari perspektif Islam merujuk kepada suatu istilah yang menjadikan keseluruhan ajaran Islam sebagai *al-Din* atau tatacara hidup. Ia bergantung kepada sejauh mana ajaran Islam itu dihayati dalam kehidupan seseorang. Religiositi Islam ini terbina daripada tiga elemen iaitu Islam, iman dan ihsan. Setiap elemen ini mempunyai rukunnya yang tersendiri iaitu rukun iman, rukun Islam dan rukun ihsan (Nur Hadi, 2019). Perkara ini dapat dilihat berdasarkan kepada hadis sahih seperti yang diriwayatkan oleh Imam Muslim, yang mengkhabarkan para sahabat melihat Jibril yang menyerupai seorang lelaki bertanyakan mengenai Islam, iman dan ihsan.

Daripada Umar R.A, beliau berkata:

بَيْنَمَا نَحْنُ جُلُوسٌ عِنْدَ رَسُولِ اللَّهِ صَلَّى اللَّهُ عَلَيْهِ وَسَلَّمَ ذَاتَ يَوْمٍ، إِذْ طَلَعَ عَلَيْنَا رَجُلٌ شَدِيدُ بَيَاضِ النَّيَابِ،
شَدِيدُ سَوَادِ الشَّعْرِ، لَا يُرَى عَلَيْهِ أَثَرُ السَّفَرِ، وَلَا يَعْرِفُهُ مِنَّا أَحَدٌ. حَتَّى جَلَسَ إِلَى النَّبِيِّ صَلَّى اللَّهُ عَلَيْهِ وَسَلَّمَ
. فَأَسَدَ رُكْبَتَيْهِ إِلَى رُكْبَتَيْهِ، وَوَضَعَ كَفَّيْهِ عَلَى فَخَذَيْهِ.

وَقَالَ: يَا مُحَمَّدُ أَخْبِرْنِي عَنِ الْإِسْلَامِ. فَقَالَ رَسُولُ اللَّهِ صَلَّى اللَّهُ عَلَيْهِ وَسَلَّمَ الْإِسْلَامُ أَنْ تَشْهَدَ أَنْ لَا إِلَهَ إِلَّا اللَّهُ وَأَنَّ مُحَمَّدًا رَسُولُ اللَّهِ، وَتُقِيمَ الصَّلَاةَ، وَتُؤْتِيَ الزَّكَاةَ، وَتَصُومَ رَمَضَانَ، وَتَحُجَّ الْبَيْتَ إِنْ اسْتَطَعْتَ إِلَيْهِ سَبِيلًا. قَالَ: صَدَقْتَ. فَعَجَبْنَا لَهُ بِسَأَلِهِ وَيُصَدِّقُهُ! قَالَ: فَأَخْبِرْنِي عَنِ الْإِيمَانِ. قَالَ: أَنْ تُؤْمِنَ بِاللَّهِ وَمَلَائِكَتِهِ وَكُتُبِهِ وَرُسُلِهِ وَالْيَوْمِ الْآخِرِ، وَتُؤْمِنَ بِالْقَدَرِ خَيْرِهِ وَشَرِّهِ. قَالَ: صَدَقْتَ. قَالَ: فَأَخْبِرْنِي عَنِ الْإِحْسَانِ. قَالَ: أَنْ تَعْبُدَ اللَّهَ كَأَنَّكَ تَرَاهُ، فَإِنْ لَمْ تَكُنْ تَرَاهُ فَإِنَّهُ يَرَاكَ.

Maksudnya: “Ketika kami duduk di sisi Rasulullah SAW pada suatu hari, tiba-tiba datanglah seorang lelaki yang sangat putih pakaiannya dan sangat hitam rambutnya, tidak kelihatan padanya tanda perjalanan jauh dan tidak ada seorang pun di antara kami yang mengenalinya.

Sehinggalah dia duduk di hadapan Nabi SAW lalu merapatkan kedua lututnya kepada lutut Baginda, lalu berkata: “Wahai Muhammad, ceritakan kepadaku tentang Islam.” Sabda Rasulullah SAW: “Islam adalah engkau bersaksi bahawa tidak ada tuhan yang disembah melainkan Allah, dan Nabi Muhammad adalah utusan Allah, engkau mendirikan Solat, menunaikan zakat, berpuasa Ramadhan dan menunaikan haji jika mampu.” Kemudian dia berkata: “Anda berkata benar”. Kami hairan, dia yang bertanya, dia pula yang membenarkan. Kemudian dia bertanya lagi: “Ceritakan kepadaku tentang Iman”. Lalu Baginda bersabda: “Engkau beriman kepada Allah, malaikat-malaikatNya, kitab-kitabNya, Rasul-RasulNya, hari akhirat dan engkau beriman kepada takdir yang baik atau yang buruk.” Kemudian dia berkata: “Anda berkata benar.” Kemudian dia berkata lagi: “Beritahukan kepadaku tentang Ihsan”. Lalu Baginda bersabda: “Ihsan adalah engkau beribadah kepada Allah seakan-akan engkau melihatNya, jika engkau tidak melihatNya maka Dia melihat engkau”.

(Riwayat Muslim, No.8)

Menerusi hadis ini, dapat diteliti bahawa setiap elemen Islam, iman dan ihsan mempunyai rukunnya yang tersendiri. Sebagaimana Rasulullah SAW menyatakan bahawa terdapat lima perkara dalam rukun Islam iaitu mengucap dua kalimah syahadah, mendirikan solat lima waktu, mengeluarkan zakat, berpuasa di bulan Ramadhan dan menunaikan haji di Baitullah sekiranya mampu. Jika seseorang Muslim dapat memenuhi kelima-lima rukun ini maka sempurnalah Islam pada dirinya dan akan terpelihara dari kemurkaan Allah SWT sekiranya ditunaikan rukun-rukun tersebut serta hukum-hukum yang berhubung kait dengan syariat Islam itu sendiri (Mustafa, 2009). Oleh itu, pensyariaan ibadah yang disebutkan dalam rukun Islam ini merupakan dasar perantara hubungan antara makhluk dan penciptanya. Secara sistematiknya, setiap Muslim diperintahkan untuk sentiasa menjaga hubungannya dengan Allah SWT tanpa mengira tempat dan waktu. Ini kerana kelima-lima ibadah ini telah tersusun bermula dengan syahadah, solat lima waktu yang wajib dikerjakan sehari semalam, zakat pada haul dan hisabnya, puasa di bulan Ramadhan selama sebulan dan menunaikan haji sekurang-kurangnya sekali seumur hidup mengikut kemampuan.

Seterusnya hadis tersebut menyebutkan Rasulullah SAW menerangkan rukun iman iaitu beriman kepada Allah SWT, para malaikatNya, kitab-kitab yang diturunkanNya, rasul-rasul yang diutusNya, ketibaan hari akhirat serta ketetapan qada' dan qadar. Kesemua rukun ini menjadi teras akidah bagi setiap Muslim yang mana kerana rukun iman inilah yang menjadikan amal dan ibadah dilaksanakan. Hal ini selari dengan takrifan para ulama hadis dan fikah seperti Imam Malik, Imam Syafie dan Imam Ahmad yang telah mentakrifkan iman

sebagai "...pembenaran dengan hati, ikrar dengan lidah dan beramal dengan sekalian rukun." (Mustafa, 2009) Berdasarkan takrifan iman yang diberikan ini, taat dalam melaksanakan suruhan Allah dan menjauhi laranganNya menjadi syarat penting kepada pembenaran iman. Perkara dalam rukun iman ini juga menjadi teras dalam pengajian para muallaf di Darul Ukhuwah dalam modul pengajian akidah mereka sejak dari tahap 1 (Modul Bimbingan Saudara Kita Akidah, 2015). Hal ini bagi memastikan para muallaf jelas dan benar-benar menghayati rukun iman ini agar dapat dapat menjadi seorang mukmin sejati.

Pengertian ihsan yang disebutkan oleh Rasulullah SAW dalam hadis di atas bermaksud seseorang menyembah Allah SWT seolah-olah dia dapat melihatNya. Jika dia tidak berupaya untuk melihat Allah SWT, maka sesungguhnya Allah SWT melihat segala amal perbuatannya. Ibadah yang dilaksanakan menurut hakikat ihsan hanya kerana Allah SWT dan ditumpukan kepadaNya semata-mata. Kesan daripada penghayatan ihsan ini menyebabkan seorang Muslim merasa lebih bertanggungjawab terhadap ibadah yang dilakukannya sehingga dia melakukan sesuatu ibadah dengan penuh kejujuran sama ada ketika berada di khalayak ramai atau ketika bersendirian. Ini kerana dia merasa yakin bahawa segala yang dikerjakannya itu dilihat oleh Allah SWT yang menyebabkannya merasa malu jika ibadah yang dilakukannya itu sekadar melepaskan tanggungjawab di dunia sahaja (Mustafa, 2009).

﴿إِنَّ اللَّهَ يَأْمُرُ بِالْعَدْلِ وَالْإِحْسَانِ وَإِيتَايَ ذِي الْقُرْبَىٰ وَيَنْهَىٰ عَنِ الْفَحْشَاءِ وَالْمُنْكَرِ وَالْبَغْيِ يَعِظُكُم لَعَلَّكُمْ تَذَكَّرُونَ ٩٠﴾

Maksudnya: "Sesungguhnya Allah menyuruh berlaku adil, dan berbuat kebaikan, serta memberi bantuan kepada kaum kerabat; dan melarang daripada melakukan perbuatan-perbuatan yang keji dan mungkar serta kezaliman. Ia mengajar kamu (dengan suruhan dan laranganNya ini), supaya kamu mengambil peringatan mematuhiNya".

(Al-Nahl: 90)

Ihsan pada ayat di atas membawa pengertian membuat kebaikan kepada diri sendiri dan orang lain. Ini kerana Allah SWT mencintai para hambaNya yang saling melakukan kebaikan sesama mereka. Allah SWT juga Maha Pemurah dalam mengurniakan kebaikan kepada makhluk sekalian alam. Namun begitu, ihsan yang dimaksudkan di dalam hadis Jibril AS adalah kesungguhan (إتقان) di dalam ibadah dan menunaikannya dengan sempurna (Al-Qurtubi, 1964).

Jika diperhatikan, ayat-ayat Al-Quran yang menyebut mengenai ihsan adalah bertemakan kepada berbuat baik dalam konteks yang sangat luas. Al-Qurtubi menjelaskan bahawa ketika ayat 90 surah Al-Nahl diturunkan dan dibacakan kepada Ali bin Abi Talib, beliau lantas berkata bahawa "Demi Allah, sesungguhnya Dia mengutuskan Rasulullah SAW dengan akhlak yang mulia." Ini mengisyaratkan bahawa ihsan mempunyai pengertian yang amat luas tetapi termasuk di dalam lingkungan berbuat baik dan melakukan kebaikan. Oleh itu, terdapat dua perkara yang dapat difahami mengenai Ihsan. Pertama, ihsan dalam ibadah adalah melakukan sesuatu ibadah dengan penuh ikhlas, bersungguh-sungguh dan memenuhi rukun, cara, kaedah yang telah ditetapkan oleh syariat Islam. Kedua, ihsan dalam makna yang lebih luas iaitu melakukan kebaikan kepada diri sendiri dan orang lain yang merentasi kesempurnaan dan kemuliaan akhlak seperti yang diajarkan oleh Rasulullah SAW.

Tiga elemen ini menunjukkan perkaitan antara akidah, syariat dan akhlak yang akan menerbitkan kehidupan Muslim yang mempunyai religiositi. Secara teori Islam, iman, dan ihsan dapat dibezakan tetapi dari segi pengamalannya tidak dapat dipisahkan. Setiap satu dan

yang lain saling berkait rapat dan memerlukan dalam membina religiositi Muslim yang kukuh. Iman merupakan aspek keyakinan dalam hati iaitu kepercayaan, manakala Islam pula bermaksud keselamatan, kesejahteraan, patuh, dan tunduk. Kemudian ihsan bererti sentiasa melaksanakan amal soleh kerana merasakan diri diperhatikan oleh Allah SWT (Asmaran, 1992). Konsep religiositi Islam dapat difahami dengan lebih jelas melalui istilah *Din* itu sendiri yang menjadikan ajaran Islam secara keseluruhan sebagai tatacara kehidupan yang mengharapkan redha Allah SWT. Religiositi atau kehidupan beragama amat penting di dalam kehidupan manusia kerana religiositi memberi pengaruh yang besar terhadap tingkahlaku, personaliti (Raba, 2001), ketenangan emosi (Kassan, 2002) keyakinan diri manusia (Qardhawi, 1985) serta kebahagiaan hidup (Hamka, 1997).

ISU DAN PERMASALAHAN

Pada masa kini, tidak dinafikan semakin ramai orang memeluk agama Islam di negeri Johor. Sebagaimana dalam rekod Jabatan Agama Islam Negeri Johor sendiri membuktikan peningkatan melalui data pengislaman Mualaf pada tahun 2018 menunjukkan seramai 755 orang mualaf telah memeluk Islam kemudian pada tahun 2019 seramai 816 orang dan pada tahun 2020 merekodkan seramai 728 orang. Seterusnya pada tahun 2021, rekod menunjukkan pertambahan mualaf seramai 688 orang telah memeluk agama Islam (Statistik Data Pengislaman Saudara Kita Bagi Daerah-Daerah Negeri Johor Darul Takzim, 2021). Hal ini kerana usaha-usaha dakwah yang telah dilakukan oleh agensi-agensi dan jabatan agama Islam sendiri yang prihatin menyebarkan dakwah Islam kepada masyarakat umum hingga ke pedalaman.

Bagi memastikan kesinambungan pengislaman para mualaf, Jabatan Agama Islam Negeri Johor telah menetapkan had tempoh mualaf selama 10 tahun atas pertimbangan untuk memberi bantuan kewangan kepada golongan mualaf sebagai asnaf di bawah agihan zakat negeri. Tambahan lagi, Menurut Zamri (2020), Jabatan agama Islam Negeri Johor telah menetapkan bahawa bantuan pendidikan diberikan kepada golongan mualaf tanpa ada had tempoh bagi mendorong para mualaf untuk lebih mendalami Islam. Majlis Agama Islam Negeri Johor juga telah menyediakan peruntukan yang besar pada setiap tahun kepada Jabatan Agama Islam Negeri Johor untuk diagihkan kepada agensi-agensi yang terlibat secara langsung dengan usaha dakwah dan pembangunan mualaf di negeri Johor.

Namun begitu, pendakwah Darul Ukhuwah Johor Bahru menyatakan bahawa kurangnya penglibatan golongan mualaf terutama yang berada dalam had tempoh 10 tahun. Kebanyakan pelajar yang hadir ke Darul Ukhuwah Johor Bahru untuk mengikuti kelas pengajian adalah golongan mualaf yang telah melepasi had tempoh mualaf 10 tahun (Rusilah, 2022). Mengikut pandangan para pendakwah di Darul Ukhuwah Johor bahru, perkara ini berlaku kerana faktor kesibukan mualaf dalam kerjaya mereka dan juga kurangnya kesedaran dalam diri mualaf itu sendiri. Ia juga berkait dengan tujuan individu mualaf itu memeluk agama Islam pada awalnya. Sebagai contoh, terdapat mualaf yang memeluk agama Islam untuk melangsungkan pernikahan. Namun setelah selesai pernikahan, individu mualaf itu tidak lagi berkunjung ke Darul Ukhuwah untuk mengikuti kelas pengajian yang dianjurkan. Terdapat juga segelintir mualaf yang memasuki kelas pengajian namun tidak memberi tumpuan terhadap pengajaran yang sedang berlangsung (Ridhwan, 2022).

Hal ini menyebabkan timbul persoalan berkenaan sejauhmanakah tahap kefahaman dan pelaksanaan Islam dalam kehidupan para mualaf di negeri johor setelah disediakan begitu banyak bantuan dan pengajian. Ini kerana pendakwah di Darul Ukhuwah Johor Bahru

menyatakan bahawa sebilangan besar mualaf yang telah melalui tempoh 10 tahun sebagai asnaf mualaf berpindah pula kepada asnaf fakir miskin. Situasi ini memberi gambaran bahawa wujudnya masalah sama ada dalam pengurusan pembangunan mualaf mahupun dalam diri mualaf itu sendiri.

Dari sudut emosi dan kerohanian pula, para mualaf telah mendapat tarbiyah dan juga didikan daripada institusi dan agensi pembangunan mualaf di sepanjang tempoh had mualafnya. Para mualaf sepatutnya telah diajarkan tentang persediaan menghadapi cabaran dan liku kehidupan dengan tenang bersandarkan kepada Allah SWT sebagai pemilik alam semesta ini. Namun akhbar Sinar Harian (2019), melaporkan bahawa terdapat mualaf yang mengalami tekanan perasaan yang teruk hingga menyebabkan penyakit mental. Hal ini menunjukkan kurangnya penghayatan konsep beriman pada qada' dan qadar dalam kalangan mualaf hingga menyebabkan mereka mengalami tekanan melampau tatkala menghadapi cabaran.

Selain itu, Malaysiakini (2011), melaporkan bahawa di seluruh negara Malaysia terdapat sebanyak 686 permohonan keluar Islam diajukan kepada mahkamah Syariah antara tahun 2000 hingga 2010. Mufti Selangor, Sahibus Samahah Dato' Setia Haji Mohd. Tamyas bin Abd. Wahid menyatakan bahawa majoriti daripada pemohon tersebut terdiri daripada saudara baru. Isu ini menjadi sesuatu yang perlu diberi perhatian dalam institusi agama Islam setiap negeri terutama di negeri Johor bagi memastikan isu ini dapat ditangani dengan baik. Hal ini menunjukkan bahawa mualaf tidak mempunyai jati diri Islam yang teguh walaupun begitu banyak usaha agensi agama Islam daripada kerajaan dan juga bukan kerajaan di seluruh Malaysia telah menyediakan pelbagai program pengajian. Menurut pendakwah Darul Ukhuwah Johor Bahru, permohonan murtad juga berlaku di daerah ini yang dilakukan oleh sebilangan individu mualaf. Namun begitu, para pendakwah yang terdiri daripada pelbagai jenis kaum akan cuba memujuk dan membawa individu yang membuat permohonan murtad untuk mendapatkan khidmat kaunseling di Jabatan Agama Islam Negeri Johor. Setakat ini tiada permohonan murtad yang diluluskan Jabatan Agama Islam Negeri Johor (Rusilah, 2022).

METODOLOGI

Kajian ini menggunakan pendekatan kualitatif dengan menggunakan kaedah pengumpulan data secara kajian perpustakaan dan menganalisis dokumen yang berkaitan dengan kajian serta temu bual. Temu bual yang dilaksanakan adalah berbentuk berstruktur dan dijalankan kepada dua orang pendakwah yang dilantik oleh Jabatan Agama Islam Negeri Johor dan bertugas di Darul Ukhuwah Johor Bahru. Analisis temu bual dilaksanakan secara tematik.

PERBINCANGAN

Berdasarkan sorotan awal dan temu bual kepada pendakwah yang dilaksanakan di Darul Ukhuwah Johor Bahru, beberapa langkah-langkah boleh dilaksanakan bagi membantu usaha pemerkasaan religiositi dalam kalangan mualaf di daerah Johor Bahru.

Pertama sekali, Darul Ukhuwah Johor Bahru memerlukan lebih banyak dana untuk mengimarahkan majlis-majlis ilmu di sana. Sebagai mana duit tambang yang diberikan kepada mualaf yang menghadiri kelas pengajian di Darul Ukhuwah. Dalam temu bual bersama Pendakwah Rusilah Binti Abullah (31 Mac, 2022), kawasan Johor Bahru memerlukan peruntukan yang lebih besar kerana bilangan mualaf di kawasan itu adalah sangat ramai berbanding daerah-daerah lain. Ia mempunyai gandaan hampir tujuh kali ganda berbanding kawasan Kulai yang merupakan daerah kedua terbanyak bilangan pengislamannya dalam

negeri Johor. Oleh itu, diharapkan peruntukan yang diberikan oleh JAINJ kepada Darul Ukhuwah Johor Bahru juga adalah tujuh kali ganda lebih besar berbanding daerah lain. Peruntukan yang besar ini dapat membantu para pendakwah untuk mengadakan program-program yang lebih memberi impak terhadap pembangunan muafak dari sudut religisiti, ekonomi dan sosial.

Seterusnya langkah penguatkuasaan mewajibkan muafak yang baru sahaja memeluk agama Islam untuk hadir ke kelas pengajian boleh dilaksanakan oleh pihak JAINJ sendiri. Hal ini kerana, JAINJ telah menyediakan peruntukan kepada muafak yang baru memeluk agama Islam untuk menerima elaun bulanan dengan bayaran sebanyak RM200 setiap bulan selama 24 bulan (Ridhwan, 2022). Ia merupakan satu pendekatan *targhib* dalam metodologi dakwah yang memberi galakan kepada *mad'u* Sebagai cadangan, di sepanjang tempoh ini JAINJ boleh menetapkan syarat muafak perlu hadir ke kelas pengajian untuk mendapatkan elaun bulanan tersebut. Ia sebagai satu usaha untuk meningkatkan kadar kehadiran golongan muafak yang berada dalam lingkungan had tempoh 10 tahun untuk lebih ramai menghadiri kelas pengajian. Pengiriman surat amaran kepada individu muafak yang tidak hadir ke kelas pengajian lebih daripada 3 sesi juga boleh dilakukan sebagai metode *tarhib* dalam metodologi dakwah. Oleh itu, isu kurangnya penglibatan muafak yang berada dalam had tempoh 10 tahun ke kelas pengajian di Darul Ukhuwah Johor Bahru dapat ditangani.

Selain itu, bilangan pendakwah perlu ditambah supaya pendakwah dapat mendekati dan menyelami jiwa muafak yang mereka dakwah. Pendekatan secara *support group* atau kumpulan *usrah* daripada kelompok muafak boleh dilaksanakan. Teknik ini akan membantu para muafak untuk meluahkan cabaran dan dugaan yang mereka hadapi serta merujuk kepada penyelesaian yang bersesuaian berpandukan hukum syarak dengan bimbingan pendakwah. Ia dapat dilaksanakan dengan cara seorang pendakwah menjadi *naqib* atau ketua bagi kelompok muafak tersebut dan mendengar serta membimbing ahli *usrah* daripada kalangan muafak mengikut kebijaksanaan dan syariat Islam. Sebagai contoh, seorang pendakwah boleh dinisbahkan kepada 10 orang muafak untuk kumpulan *usrah* tersebut agar bilangannya tidak terlalu ramai hingga mengakibatkan pendakwah boleh terlepas pandang atau tidak cukup tangan untuk membimbing mereka.

Seterusnya, langkah lain yang boleh dilaksanakan bagi memperkasakan religisiti muafak di Darul Ukhuwah Johor Bahru ialah dengan memperkenalkan dan menghubungkan individu muafak kepada ahli jawatankuasa masjid berdekatan tempat tinggal mereka. Sebagai cadangan, tindakan ini boleh dilaksanakan dengan kerjasama Unit Ukhuwah Saudara Kita dan Bahagian Pengurusan Masjid dalam JAINJ. Secara hikmahnya, para muafak yang diperkenalkan kepada ahli jawatankuasa masjid berdekatan akan menjadikan mereka mudah mendapat info mengenai majlis-majlis ilmu dan juga sambutan-sambutan dalam Islam. Ahli jawatankuasa masjid juga akan menjadi lebih prihatin terhadap ahli kariah setempat mereka yang terdiri daripada individu muafak yang memerlukan lebih sokongan dan bimbingan dalam usaha memahami dan mengamalkan ajaran Islam.

Tambahan lagi, sikap individu muafak itu sendiri perlu diberi perhatian dan motivasi. Hal ini kerana, segelintir muafak telah mencampakkan diri mereka untuk terus menagih dana dan bantuan daripada pihak berkuasa dan masyarakat sekeliling. Namun apa yang berlaku, segelintir muafak ini tidak memanfaatkan dana atau bantuan yang diberikan untuk memajukan diri dalam bidang pendidikan atau keusahawanan. Bahkan mereka hanya menggunakannya untuk dibelanjakan demi kesenangan semasa sehingga habis. Menurut Ketua Penolong Pengarah Bahagian Dakwah JAINJ Tuan Haji Mohd. Zamri Bin Kambari, bantuan enjin bot

diberikan kepada muallaf yang berkelayakan untuk menjana pendapatan sebagai seorang nelayan. Namun, terdapat segelintir muallaf yang menjual enjin bot tersebut bagi tujuan memperolehi wang tunai yang ingin dibelanjakan mengikut kemahuan mereka sendiri. Oleh itu, kursus latihan dan motivasi perlu diberikan kepada para muallaf supaya mereka mempunyai kesedaran diri untuk memajukan diri mereka sehingga mempunyai kebolehpayaan dalam menjana pendapatan sendiri tanpa mengharapkan bantuan luar. Dengan ini, para muallaf dapat menjadi seorang Muslim yang berkerjaya dan mampu membantu saudara Muslim lain yang memerlukan menerusi pembayaran zakat, infak dan sedekah hasil daripada penghayatan nilai religiositi Islam itu sendiri.

KESIMPULAN

Hasil kajian ini mendapati bahawa pengukuran tahap religiositi dalam kalangan muallaf di Darul Ukhawah Johor Bahru adalah perlu bagi mengenalpasti sejauhmanakah kefahaman dan pelaksanaan agama Islam dalam kalangan muallaf. Tambahan lagi, bilangan pengislaman yang terbesar di negeri Johor adalah di daerah Johor Bahru dan mereka terdiri daripada pelbagai latar belakang serta kaum. Oleh itu, kajian pengukuran tahap religiositi yang akan dilakukan dapat mengkaji tahap religiositi muallaf daripada pelbagai sudut dan pelbagai isu permasalahan dalam kalangan muallaf dalam diselidik dan ditangani bersama.

PERAKUAN

Bahawasanya artikel ini ditulis berdasarkan penyelidikan yang dibantu melalui dana Geran Penyelidikan Pascasiswazah (GPPS), di bawah Projek H736, Universiti Tun Hussein Onn Malaysia dan Kementerian Pengajian Tinggi Malaysia.

RUJUKAN

- Abu Husain Muslim, Sahih Muslim, No. Hadis: 8.
- Abullah Muhammad Abdurahman Ishaq. (2004). Tafsir Ibnu Katsir, Jilid 6, (Terj), M. Abdul Ghoffar E.M & Abu Ihsan al-Atsari, Bogor: pustaka imam asy-syafi'i
- Abdul Malik Abdul Karim Amrullah. (1984). Tafsir al-Azhar, Surabaya: Yayasan Latimojong.
- Abdullah Muhamad Basmeh. (1990). Tafsir Pimpinan al-Rahman, Bahagian Hal Ehwal Islam Jabatan Perdana Menteri, Kuala Lumpur: Utusan Print Corp Sdn Bhd.
- Abdullah Muhammad Zin. (1998). Prinsip dan Kaedah Dakwah Dalam Arus Pembangunan Malaysia. Bangi: Penerbit Universiti Kebangsaan Malaysia.
- Ahmad Mushthafa Al-Maraghi. (1989). Tafsir Al-Maraghi 22. (Terj), K. Anshori Umar Sitanggal, Semarang: Penerbit Toha Putra, h. 29
- Al-Marri, T. S. K., Oei, T. P. S., & Al-Adawi, S. (2009). The development of the short Muslim practice and belief scale. *Mental Health, Religion and Culture*, 12, (5), 415-426. doi:10.1080/13674670802637643
- Al-Qardawi, Y. (1993). "Pengertian Tauhid." Kuala Lumpur, Pustaka Salam Sdn.Bhd.
- Asmaran AS, Pengantar Study Tauhid, Jakarta: Rajawali Prees, 1992, h.84
- Azma Mahmood, (2006). Pengukuran Tahap Penghayatan Pendidikan Islam Pelajar-Pelajar Sekolah Menengah di Malaysia. Tesis PhD. Bangi: Universiti Kebangsaan Malaysia.
- Hamka. (1997). Tasauf Moden. Singapura: Pustaka Nasional PTE LTD.
- Irwan, M.S, Azman, A.R, Mahazan, A.M, Nuradli Ridzwan Shah, M.D, Wan Mohd. Fazrul Azdi, W.R, Rose Irnawaty, Ibrahim, Siti Nurunnajwa Shamsudin, Nusaibah Anuar Musaddad & Norlina Ismail, (2015). Penerimaan Penggunaan Istilah Muallaf Dalam Kalangan Muallaf Di Malaysia. *Jurnal Infad* vol 6.

- Jamiah Manap, et.al (2013). Prinsip Pengukuran Religiositi dan Personaliti Muslim. Pusat Pengajian Umum, Universiti Kebangsaan Malaysia.
- Kassan, H. (2002). Kesihatan jasmani dan rohani sebagai asas kejayaan menurut Islam. Pusat Pengajian Umum, Universiti Kebangsaan Malaysia.
- Md. Buranuddin Tibek, et.al (2015). Modul Bimbingan Saudara Kita “Akidah”, Bahagian Dakwah Jabatan Agama Johor.
- Mustafa, A. R. (2009). Hadis Empat Puluh. Shah Alam: Dewan Pustaka Fajar.
- Mustafa Masyhur (2004), Jalan Da’wah Antara Keaslian dan Penyelewengan. (Terj.) Mohd. Yusuf Ismail, Cet. Keempat, Kuala Lumpur: Penerbit Dewan Pustaka Fajar, h. 107.
- Nur A’thiroh Masyaa’il Tan Abdullah @ Tan Ai Pao; Fariza Md Sham. (2009). Keperluan Memahami Psikologi Saudara Muslim. Jurnal Hadhari vol 2.
- Nur Hadi, (2019). Islam, Iman Dan Ihsan Dalam Kitab Matan Arba‘In An-Nawawi: Studi Materi Pembelajaran Pendidikan Islam dalam Perspektif Hadis Nabi SAW. *Jurnal Intelektual: Jurnal Pendidikan dan Studi Keislaman*. Volume 9, Nombor 1.
- Rafiza Mohamed, (2013). Tret Personaliti dan Religiositi gelandangan Muslim di Pusat Rujukan Intervensi Anjung Singgah (PRIAS). Bangi: Universiti Kebangsaan Malaysia.
- Said bin Ali Al-Qahtani. (1994), Da’wah Islam Da’wah Bijak. (Terj) Masykur Hakim, Jakarta: Penerbit Gema Insani Press, h. 97
- Sayid Sabiq, (2004), Akidah Islam Pola Hidup Manusia Beriman. (Terj) M. Abdai Rathomy, Singapura: Pustaka Nasional Pte Ltd.
- Selamat, M.I, (1996). “Sifat-sifat Allah dan Mentauhidkan Diri Kepada-Nya.” Kuala Lumpur: Darul Nu’man.
- Wahbah az-Zuhaili, (2003). Tafsir al-Munir, Jakarta: Gema Insani.
- Yusuf al-Qardhawi (2000), Tazkirah Para Pendakwah. Kuala Lumpur: Penerbit Al-Hidayah Publishers, h. 10.
- Zainab Ismail, Wan Ibrahim Wan Ahmad, Nor Salimah Mansur. (2010). Dimensi Penghayatan Agama Mengikut Pendapat Tokoh Agama Semasa, Jurnal Pembangunan Sosial, Jilid 13, Jun, h.37-56.
- (2010). Kamus Dewan (Edisi keempat). Kuala Lumpur: Dewan Bahasa dan Pustaka.
- Sumber Maklumat Fatwa Jakim mengenai Had Tempoh Mualaf daripada laman sesawang <http://e-smaf.islam.gov.my/e-smaf/index.php/main/mainv1/fatwa/pr/15872>
- Takrifan Asnaf Mualaf menurut Majlis Agama Islam Negeri Johor daripada laman sesawang <https://www.maij.gov.my/agihan/takrif-asnaf>
- Terjemahan Hadis Sahih Muslim no. 8 daripada laman sesawang <https://muftiwp.gov.my/artikel/al-afkar/3148-al-afkar-44-bolehkah-manusia-biasa-melihat-jibrail-as>
- Akhbar Sinar Harian Berita Mualaf didakwa dua Pertuduhan Rogol <https://www.sinarharian.com.my/article/133689/BERITA/Semasa/Mualaf-didakwa-dua-pertuduhan-merogol>

Penterjemahan Frasa Kerja Melayu-Arab Menggunakan *Google Translate* dan Terjemahan Manusia: Satu Kajian Perbandingan Menurut Aspek Masa

Mohd Ikhwan bin Abdullah
International Islamic University Malaysia
mohdikhwan@iium.edu.my

Raja Nur Hanisah binti Raja Sulaiman
Al-Fasoha Academic of Arabic
nurhanisah0296@gmail.com

ABSTRAK

Hasil dapatan kajian-kajian analisa konstrastif membuktikan terdapat beberapa persamaan dan perbezaan antara penggunaan frasa kerja bahasa Melayu dan bahasa Arab dari aspek masa. Namun, perbezaan dilihat lebih ketara berbanding persamaan, memandangkan kedua-dua bahasa ini berasal daripada keluarga bahasa yang berbeza. Ini sekaligus memberi kesan kepada terjemahan manusia sendiri apatah lagi terjemahan mesin. Oleh itu, kajian ini bertujuan membuat perbandingan antara terjemahan manusia (terjemahan novel Ustaz) dan terjemahan mesin (terjemahan Google) dalam menterjemahkan frasa kerja khususnya dari aspek masa serta membandingkan kelebihan dan kekurangan antara kedua-duanya. Kajian menggunakan pendekatan kualitatif iaitu kaedah analisa kandungan bagi membandingkan antara dua terjemahan ini. Pensampelan rawak digunakan bagi mendapatkan sampel frasa kerja dari novel. sampel-sampel ini kemudian dimasukkan ke terjemahan Google Translate bagi mendapatkan terjemahannya. Hasil terjemahan kedua-dua jenis terjemahan ini dianalisa berpandukan kerangka teori berkaitan perujukan masa bagi frasa kerja yang disebutkan oleh beberapa tokoh nahu moden seperti Tammam Hasan, Mahdi Makhzumi, manakala terjemahan ke bahasa Melayu pula dinilai berpandukan kerangka terjemahan frasa kerja yang dicadangkan oleh Ashafizrol Ab Hamid. Terjemahan manusia didapati lebih menepati makna yang dibawa oleh teks sumber iaitu bahasa Melayu. Namun, ini tidak menafikan kualiti yang dihasilkan oleh terjemahan Google. Dari sudut kemampuan terjemahan Google Translate dalam menzahirkan perujukan masa dari bahasa Melayu yang berbeza cara perujukannya.

Kata Kunci: Frasa kerja bahasa Arab; Frasa Kerja bahasa Melayu; Aspek dan Masa; Terjemahan Mesin; Google Translate

PENDAHULUAN

Terjemahan adalah antara kemahiran yang sangat penting dalam membentuk kemampuan berbahasa dan perhubungan sesama manusia. Kemunculan teknologi membantu menggiatkan lagi aktiviti penterjemahan yang dinamakan sebagai terjemahan mesin. Terjemahan ini memanfaatkan pelbagai jenis teknologi yang mampu menghasilkan terjemahan seperti terjemahan manusia. Kemunculan teknologi kepintaran buatan meningkatkan lagi kualiti terjemahan mesin. Semakin besar data yang menjadi rujukan terjemahan mesin, semakin baik terjemahan yang dapat dihasilkan.

PERMASALAHAN KAJIAN

Meskipun teknologi maklumat telah berkembang pesat, terjemahan mesin juga sering dilihat sebagai terjemahan yang tidak tepat kerana tidak mengambil kira beberapa aspek yang memerlukan bantuan kefahaman manusia. Kajian Sjahrony & Maheram (2013) mendapati

bahawa terjemahan Google tidak mampu menterjemah frasa idafah dengan sempurna dan terjemahan manusia tetap mempunyai nilai dan kualiti yang lebih baik berbanding terjemahan mesin. Stanovsky, Smith & Zettlemyer (2019) mendapati bahawa terdapat terjemahan mesin menghasilkan kesalahan terjemahan yang merujuk kepada bias jantina terutamanya dalam terjemahan Bahasa Sepanyol ke bahasa Inggeris. Perbezaan struktur dan tatabahasa juga memberi kesan terhadap terjemahan Google. Ndapa Lawa et al (2022) menegaskan, walaupun terjemahan Google sudah mampu meningkatkan kualiti terjemahan hasil penerapan kaedah neural mechanic translation, namun masih terdapat banyak kesalahan terjemahan yang melibatkan perbezaan linguistik seperti kata kerja, jamak, dan lain-lainnya.

Frasa idiomatik juga sering dikaitkan dengan terjemahan mesin kerana ia memerlukan pemahaman terhadap budaya bahasa asal (Kendrigan, 2014). Kajian Hidayatul Khoiriyah (2020) mendapati bahawa terjemahan Google seringkali menterjemah perkata dalam ungkapan-ungkapan yang memerlukan penaakulan dan penelitian. Kajian Mohamad Nor Amin & Naimah Abdullah (2011) mendapati masih terdapat berbagai kelemahan yang terhasil dalam khidmat terjemahan Google Translate terutamanya dalam aspek semantik, antaranya kata nama tunggal, kata kerja, frasa, partikel dan ekspresi. Dari sudut kesepadanan kaedah, Sa'diah (2014) mendapati Google Translate masih mengandungi kesalahan terjemahan yang melibatkan kesalahan tatabahasa seperti padanan antara subjek- predikat dalam aspek maskulin dan feminin.

Rata-rata kajian menyimpulkan terdapat kesalahan terjemahan dari pelbagai sudut. Namun, dari sekian banyak kajian mengenai ketepatan terjemahan *Google Translate* ini, pengkaji mendapati belum ada yang mengkaji penterjemahan frasa kerja bahasa Arab dari sudut aspek dan masa. Bahasa Arab mempunyai kerencaman yang sangat agak rumit dalam sudut frasa kata kerjanya. Rasionalnya, frasa ini sukar diterjemahkan oleh manusia, apatah lagi mesin. Contoh yang paling jelas membuktikan hal ini adalah Bahasa Melayu tidak mempunyai kata bantu aspek khas untuk كان*Kiaitu* yang padanan Inggerisnya adalah was/were. Selain itu, Bahasa Melayu tidak mempunyai bentuk khusus bagi kata kerja yang merujuk kepada masa lepas. Ini menimbulkan persoalan: Bagaimana terjemahan manusia dan terjemahan mesin menangani perbezaan ini? Adakah terjemahan manusia masih lebih baik berbanding terjemahan mesin?

OBJEKTIF KAJIAN

- 1- Menghimpunkan dan mencadangkan terjemahan sesuai bagi setiap frasa kata kerja dalam bahasa Arab.
- 2- Membandingkan terjemahan manusia dan terjemahan Google Translate dalam menterjemah frasa kata kerja dari sudut aspek dan masa.
- 3- Menganalisa kemampuan terjemahan mesin dalam menzahirkan perujukan masa dari bahasa Melayu yang berbeza cara perujukannya.

METODE KAJIAN

Analisa kajian dijalankan dengan menggunakan kaedah analisa kandungan (*content analysis*) terhadap korpus yang berbentuk novel. Analisa data melibatkan dua bentuk terjemahan iaitu:

- 1- Terjemahan novel 'Ustaz' karya S. Othman Kelantan ke bahasa Arab oleh Sultan Ahmad bin Abdur Rahman, mewakili terjemahan manusia.
- 2- Terjemahan Google Translate, mewakili terjemahan mesin.

Pemilihan sampel dilakukan secara bersasar (*purposeful sampling*) di mana terdapat beberapa frasa kerja telah dikenalpasti, bermula dengan frasa kerja yang merujuk masa lepas, masa sekarang dan depan.

1. كان قد فعل
2. كان يفعل
3. قد فعل
4. كاد يفعل
5. بدأ يفعل
6. ظل يفعل

Frasa kerja ini dipadankan dengan frasa kerja bahasa Melayu bagi mendapatkan perujukan masa yang betul menurut tatabahasa Melayu.

METODE ANALISA

Analisa kajian ini menggunakan pendekatan perbandingan. Kedua-dua terjemahan ini diletakkan sebelah-menyebelah bagi menampakkan perbandingan, disertakan dengan teks asal. Perbandingan dilakukan dengan melihat sejauh mana frasa yang diterjemahkan ke bahasa Arab itu benar-benar mencerminkan aspek masa dalam bahasa Melayu. Ulasan diberikan setiap kali selesai perbandingan.

FRASA KERJA BAHASA ARAB DARI SUDUT ASPEK DAN MASA

Tajuk ini tidak dibahaskan oleh para pengkaji silam sebagai frasa seperti yang didapati dalam tatabahasa Inggeris iaitu apa yang dinamakan *tenses of verbs*. Atas faktor revolusi kajian bahasa yang berlaku di barat, terdapat beberapa pengkaji nahu Arab moden membahaskan frasa kata kerja ini, tetapi padanannya dalam Melayu masih diperselisih.

Mahdi Makhzumi (1986) menyatakan bahawa kata kerja bahasa Arab boleh dibentuk menjadi frasa kata kerja bagi menentukan aspek masa. Frasa ini terbentuk menggunakan fiil كان. Sebagai contoh, apabila كان diikuti oleh فعل (fiil madhi), maka ia merujuk kepada masa lepas jauh (dahulu), manakala apabila ia diikuti oleh يفعل (fiil mudhari'), seperti (كان زيد يضحك) maka ia merujuk kepada perbuatan ketawa pada waktu lepas. Sekiranya fiil madhi didahului dengan (قد), maka ia merujuk kepada masa lepas yang hampir dengan masa sekarang. Tetapi jika (كان فعل) digandingkan dengan كان maka ia merujuk kepada masa lepas jauh seperti (كان قد فعل) و(قد كان فعل) و(كان قد فعل)

Tammam Hasan (1994) membahagikan frasa kerja mengikut bentuk (فعل) و(يفعل) berdasarkan aspek-aspek masa yang disebutkan dalam tatabahasa Inggeris seperti، والانقطاع، الجاه، dekat, terputus, bersambung, selesai, berterusan, hampir, mula dan beberapa aspek yang terdapat pada bahasa Arab seperti، والقرب، المقاربة، والشروع، والبعيد، الجاهة المنقطعة. Beliau turut membahagikan kerangkanya berdasarkan jenis ayat seperti ayat penyata، الجملة المنفية، والجملة الخبرية المثبتة. Jadual di bawah menjelaskan frasa kerja yang disusun oleh Tammam Hasan:

صيغة فعل يَفْعَل Bongkah	صيغة فَعَل فَعَل Bongkah	الجهة Aspek	الزمن Masa
	كان فعل	البعيد المنقطع	الماضي

	كان قد فعل كان يفعل قد فعل ما زال يفعل ظل يفعل فعل كاد يفعل طفق يفعل	القريب المنقطع المتجدد المنتهي بالحاضر المتصل بالحاضر المستمر البسيط المقارب الشروعي	Masa lepas
يفعل يفعل يفعل		العادي التجدي الاستمراري	الحال Masa sekarang
يفعل سيفعل سوف يفعل سيظل يفعل		البسيط القريب البعيد الاستمراري	الاستقبال Masa akan datang

Jadual 1: Aspek dan Masa Frasa Kata Kerja Bahasa Arab Menurut Tammam Hasan

Fāḍil Sālīḥ Sāmurrāi (2017) juga menyebutkan frasa kerja dengan menggandingkan kata kerja (كان). Apabila ia digandingkan dengan fiil madhi (كان فَعَلَ), ia merujuk kepada kejadian, keadaan atau tindakan yang berlaku dan tidak lagi berlaku. Ia juga menunjukkan makna masa sekali. Contohnya: (كان كذب) bererti dia pernah berdusta sekali. Ini membezakan gandingan dengan isim fā'il iaitu (كان كاذبًا) yang bererti dia dulu selalu berdusta. Beliau juga menyebutkan frasa (كان سيفعل) yang membawa makna menjangkakan sesuatu akan berlaku pada masa lepas, tetapi ia tidak berlaku. Contohnya: (كان محمد سيكتب لك في هذا الأمر) Muhammad hampir hendak menulis surat kepadamu menyatakan hal ini (tetapi ia tidak berlaku). Selain yang telah disebutkan oleh Tammam Hassan, Al-Sāmurrāi manambah beberapa frasa kerja iaitu

(يكون قد فعل)

(كان إذا فعل+فعل)

(كان لا يزال)

1. (يكون قد فعل) bagi menyatakan bahawa sesuatu tindakan, kejadian atau keadaan dijangkakan seolah-olah telah berlaku pada masa depan. Ayat ini, mengandungi makna keterangan syarat, Contohnya (اذهب إليه فتكون قد سبقته بالفضل) pergilah kepadanya, (jika kamu berbuat demikian) maka kamu telah mendahuluinya dalam membuat kebaikan. Perihal mendahului membuat kebaikan belum lagi berlaku tetapi ia dianggap telah berlaku sekiranya syaratnya iaitu pergi telah berlaku.
2. (كان إذا فعل+فعل) menurut Al-Sāmurrāi frasa ini membawa makna kebiasaan pada waktu lepas, contohnya (كان محمد إذا سئل أعطى) bererti Menjadi kebiasaan Muhammad memberi setiap kali diminta.
3. (كان لا يزال) yang membawa makna bahawa sesuatu tindakan, kejadian atau keadaan berlaku secara berterusan pada waktu lepas (كان لا يزال يلهو) bermakna, dia ketika itu masih lagi bersenang-senangan, kemudian berhenti.

Beliau juga menyebut frasa kerja yang terbentuk daripada kata tugas (قد) dan maknanya bergantung kepada jenis fiil yang digandingkan.

Jika digandingkan dengan fiil madhi (قد فعل) ia membawa makna:

- 1- 'Dekat dengan masa sekarang' seperti yang disebutkan dalam lafaz iqamat (قد قامت الصلاة),
- 2- Penegasan bahawa sesuatu tindakan, kejadian atau keadaan benar-benar telah berlaku pada waktu lepas. Ini kerana terdapat penggunaan fiil madhi merujuk kepada masa

depan (وَنُفِخَ فِي الصُّورِ فَصَعِقَ مَنْ فِي السَّمَوَاتِ وَمَنْ فِي الْأَرْضِ) ⁷¹ maka, dengan قد, jelaslah bahawa sesuatu frasa itu merujuk masa lepas.

- 3- Ia juga digunakan bagi menjangkakan bahawa sesuatu yang dinanti-nantikan sudah berlaku ⁷². Sebagai contoh, semua sedang menantikan ketibaan ustaz, maka tatkala seseorang yang melihat petanda ketibaan ustaz (قد حضر الأستاذ) Ustaz sudah datang.

TERJEMAHAN FRASA KERJA

Ashafizrol Abdul Hamid (2016) dalam bukunya Binaan Ayat Bahasa Arab memberikan padanan bagi setiap frasa kerja yang kebanyakannya telah disebutkan oleh pengkaji-pengkaji sebelumnya:

1. (قد فعل) Telah pun berlaku

قد غادرت الطائرة قبل وصولك بدقائق	Kapal terbang telah pun berlepas beberapa minit sebelum kamu sampai.
-----------------------------------	-----------------------------------------------------------------------------

2. (كان فعل) Dahulu

كنا حسبناهم علماء	Dahulu kami ingatkan mereka adalah ulamak
-------------------	-------------------------------------------

3. (كان قد فعل) Boleh diterjemah kepada:

3a: Ketika...sudah pun...

عندما وصلوا إلى القرية كان الظلام قد حلّ	Ketika mereka sampai di kampung, hari sudah pun gelap
------------------------------------------	-------------------------------------------------------

3b: Dahulu..telah pun

ولم يترك هذه العادة إلا حين خطب قرينته فأخرجته من عادات كثيرة كان قد ألفها) وترجمتها	Beliau tidak meninggalkan tabiat itu kecuali setelah bertunang dengan isterinya. Isterinya telah mengeluarkannya dari berbagai-bagai tabiat yang dahulu beliau telah pun terbiasa dengannya
--------------------------------------------------------------------------------------	---------------------------------------------------------------------------------------------------------------------------------------------------------------------------------------------

3c: Pernah

كان قد سافر إلى مصر	Dia pernah pergi ke Mesir
---------------------	---------------------------

4. (يكون قد فعل) boleh diterjemah kepada:

4a: Bermakna telah

ولكن إن تجاهلته أكون قد تركت سهام تذهب نحو الهاوية	Tapi jika aku mengambil sikap tidak peduli aku telah membiarkan Siham menuju ke arah kehancuran
----------------------------------------------------	-------------------------------------------------------------------------------------------------

4b: Kalau-kalau telah

خاف أن أكون قد أخبرت والده	Dia risau kalau-kalau aku telah memberitahu bapanya
----------------------------	-----------------------------------------------------

5. (كان يفعل) Boleh diterjemah kepada beberapa terjemahan:

5a: ketika...dia sedang..

⁷¹ الزمر: 68.

⁷² المرجع نفسه، ج 1، ص 310.

عندما اتصلت كنت ألقى الدرس في قاعة المحاضرات	Waktu kamu menelefon, aku sedang mengajar dalam dewan kuliah
----------------------------------------------	--------------------------------------------------------------

5b: dulu

زعموا أنّ ابن أوى كان يسكن في بعض الدحال	Mereka mendakwa anjing hutan dahulu tinggal dalam lubang sarang
------------------------------------------	-----------------------------------------------------------------

5c: Tadi

أين كُنْتُ؟ كُنْتُ في دورة المياه	Di mana kamu tadi? Tadi saya di bilik air
-----------------------------------	-------------------------------------------

6. (ما زال يفعل) masih lagi.

صرخة الطفل ما زالت تتردد في أذني	Jeritan kanak-kanak itu masih lagi terngiang-ngiang di telingaku
----------------------------------	------------------------------------------------------------------

7. (ظل يفعل) terus melakukan sesuatu

ظل يراجع دروسه	Dia terus mengulang kaji pelajarannya
----------------	---------------------------------------

8. (بدأ يفعل) mula melakukan sesuatu

بدأت دموعها تدرف وتتهار على وجنتيها	Air matanya mula mengalir dan menitisi pipinya
-------------------------------------	------------------------------------------------

9. (كاد يفعل) boleh diterjemahkan (dia hampir melakukan sesuatu, hampir-hampir, nyaris, sedikit lagi)

كدت أنسى أنه ينتظرنني في المكتبة	Aku hampir terlupa yang dia sedang menungguku di perpustakaan
----------------------------------	---------------------------------------------------------------

10. (سيفعل) أو (سوف يفعل) akan.

وأعجب من هذا أنني أراه سيصفح عنه	Apa yang lebih pelik ialah aku lihat dia akan memaafkannya
----------------------------------	------------------------------------------------------------

ANALISA TERJEMAHAN SULTAN DAN GOOGLE

فراسا قد خرج كان

Padanan bagi frasa ini adalah..‘ketika itu..sudah pun..’

Data 1

Waktu saya sendiri pun, masuk dua tahun baru habis surat besar. Sedangkan kawan-kawan hanya dalam satu tahun atau kurang daripada satu tahun. Akhirnya, sehingga sekarang saya sudah sampai ke Mesir, mereka itu tidak. Semuanya mesti tekun dan sabar. (*Al-Ustaz, hlm 36*)

Terjemahan Sultan	Terjemahan Google
أنا كذلك وصلت إلى السور الطوال بعد سنتين، في حين كان زملائي قد وصلوا إليها في سنة واحدة أو أقل، والآن أنا قد	حتى في وقتي ، استغرق الأمر عامين لإنهاء الرسالة الكبيرة. بينما الأصدقاء فقط في سنة واحدة أو أقل من سنة.

ذهب إلى مصر وهم لم يذهبوا، فكل شيء يحتاج إلى الجهد والصبر والثبات.	أخيرًا ، حتى الآن وصلت إلى مصر ، فهم ليسوا كذلك. يجب أن يكون كل شيء ذووياً وصبوراً.
--------------------------------------------------------------------	-------------------------------------------------------------------------------------

Ulasan:

Menurut data ini, didapati terjemahan Sultan lebih menepati aspek dan masa bagi frasa tersebut, ini kerana, frasa كان قد فعل (كان زملائي قد وصلوا) digunakan bagi menjelaskan suatu kejadian telah berlaku lebih awal daripada kejadian lain pada masa lepas. Kejadian yang berlaku terlebih awal yang dimaksudkan itu adalah ‘menghabiskan surat besar sebelum masuk 2 tahun’ oleh rakan-rakannya berbanding penulis yang habis membaca surah besar dalam masa 2 tahun. Manakala terjemahan Google tidak menggunakan kata kerja كان bagi merujuk kepada masa lepas.

Namun, terdapat kesalahan terjemahan pada وصلت إلى السور الطوال, di mana teks asal mengatakan bahawa penulis habis membaca surat besar (Quran), bukan sekadar ‘sampai’ ke surat besar.

Data 2

Kamal Bahrin menyatakan akan menjemput ustaz Saifuddin ke rumahnya di Pancur tetapi malam itu Ustaz Saifuddin sudah keluar lagi kerana berceramah di suatu kawasan yang jauh (Ustaz, hlm 77)

Terjemahan Sultan	Terjemahan Google
قال كمال البحرين بأنه سيدعو الأستاذ سيف الدين إلى بيته في فانتشور، ولكن الأستاذ سيف الدين مرة أخرى لم يكن في البيت لأنه كان قد خرج لإلقاء المحاضرة في منطقة بعيدة	صرح كمال بحرين أنه سيدعو الأستاذ سيف الدين إلى منزله في بانكور ولكن في تلك الليلة كان الأستاذ سيف الدين قد غادر بالفعل لأنه كان يلقي محاضرة في منطقة بعيدة.

Ulasan:

Sekali lagi, frasa كان قد فعل digunakan oleh Sultan dan juga Google bagi menjelaskan bahawa kejadian Ustaz Saifuddin ‘keluar berceramah’ sudah pun berlaku lebih awal daripada kejadian Kamal menjemput beliau ke rumahnya. Terjemahan Google juga menggunakan frasa yang sama, cuma ia menggantikan kata kerja غَادَرَ dengan خَرَجَ, selain menambah frasa بالفعل bagi tujuan penegasan. Ini menunjukkan bahawa terjemahan Google dapat memahami keperluan penggunaan كان pada tempatnya yang sesuai.

Data 3

Hari Ahad itu dia datang, kakak keluar dengan abang Kamalul (Ustaz, hlm 98)

Terjemahan Sultan	Terjemahan Google
في يوم الأحد الذي جاء فيه ، خرجت أختي مع شقيق كمال	أتى يوم الأحد، ولكنك كنت قد خرجت مع الأخ كمال البحرين

Ulasan:

Penggunaan frasa كان قد خرج (كنت قد خرجت) oleh terjemahan Google dilihat tidak bertepatan dengan kehendak teks asal, kerana ia tidak menjelaskan perihal ‘keluar’ berlaku lebih awal daripada tibanya hari Ahad, tetapi ia hanyalah pernyataan tentang bila kejadian keluar itu berlaku iaitu pada hari Ahad. Maka terjemahan Sultan dilihat lebih menepati kehendak frasa. Selain terdapat kesalahan pada perujukan kata ganti nama diri, di mana perujukan yang tepat adalah kepada kata ganti nama diri ketiga.

Data 4

Laung Sayuti Akbar dari tingkap dan seperti tidak sabar terus saja berlari keluar. Ketika itu Ustaz Saifuddin sudah berada di tengah-tengah halaman (Ustaz, hlm 114)

Terjemahan Sultan	Terjemahan Google
صاح سيوطي أكبر من النافذة...جرى مسرعا إلى الخارج نحو الأستاذ. وفي تلك اللحظة كان الأستاذ سيف الدين قد وصل إلى ساحة البيت	لونغ ساويتي أكبر من النافذة وكان الصبر نفذ للتو. في ذلك الوقت ، كان الأستاذ سيف الدين موجودًا بالفعل في منتصف الفناء

Ulasan:

Penggunaan frasa (كان الأستاذ سيف الدين قد وصل) كان قد فعل oleh terjemahan Sultan menepati makna yang terkandung dalam teks asal, kerana ia menjelaskan bahawa ‘keberadaan Ustaz Saifuddin’ mendahului perihal ‘laungan Sayuti sambil berlari keluar’. Manakala terjemahan Google menggunakan frasa كان diikuti kata nama موجودًا بالفعل (كان...موجودًا بالفعل) agak janggal bagi konteks ini kerana kata bantu aspek ‘sudah’ tidak dapat dizahirkan melainkan dengan kata tugas قد.

Data 5:

Dia pernah mendengar kisah cinta anaknya...

Terjemahan Sultan	Terjemahan Google
فقد سبق له أن سمع حكاية حب ابنته...	كان قد سمع بقصة حب ابنه ...

Ulasan:

Kedua-dua terjemahan menggunakan frasa yang sesuai bagi menterjemahkan kata bantu aspek ‘pernah’ iaitu كان قد فعل dan سبق أن فعل.

Frasa كان يفعل

Frasa ini boleh diterjemahkan kepada beberapa makna, antaranya : ‘Dahulu selalu’, ‘ketika itu sedang’, ‘dulu’, atau sekadar menjelaskan perujukan masa lepas secara umum.

Data 1

Persahabatannya intim dan saling menghormati (Ustaz, hlm 5)

Terjemahan Sultan	Terjemahan Google
الصدقة بينهما كانت حميمة وكانا يحترم أحدهما الآخر	الصدقة حميمة واحترام متبادل

Ulasan:

Dalam terjemahan ini, dilihat terjemahan Sultan menggunakan frasa كان يفعل bagi menjelaskan bahawa perihal ‘keakraban dan saling menghormati’ antara mereka itu merujuk kepada masa lepas. Ini berterpatan dengan konteks cerita dalam novel. Manakala terjemahan Google tidak berbuat demikian, sebaliknya perujukan masanya adalah kepada masa sekarang.

Data 2:

Datuk sebelah ibunya seorang lebai yang juga mengajar hukum-hakam (hlm 25)

Terjemahan Sultan	Terjemahan Google
جده من أمه: كان مأذونا وكان يدرس الأحكام الشرعية	كان جده لأمه الذي كان يدرس القانون أيضًا

Ulasan:

Kedua-dua terjemahan memahami maksud perujukan masa dari teks asal. Ini kerana, teks sedang menceritakan perbuatan orang yang sudah meninggal yang dilakukannya secara berterusan pada masa lepas selaku seorang lebai. Oleh itu, frasa **كان يفعل** sangat sesuai digunakan.

Data 3:

Dan ingatannya segera kembali...**ketika** dia **menghabiskan** masa belajarnya (hlm 29)

Terjemahan Sultan	Terjemahan Google
وسرعان ما تحولت ذاكرته... حينما كان يقضي مرحلة دراسته	وعادت ذاكرته على الفور... عندما قضى فترة دراسته

Ulasan:

Terjemahan Sultan lebih menepati kehendak teks iaitu perihal mengimbau kenangan seolah-olah ia sedang berlaku. Mekan frasa **كان يفعل** sesuai digunakan. Manakala terjemahan Google hanya menggunakan fiil madhi secara tunggal. Ia tidak boleh dianggap salah, cuma makna mengimbau kenangan itu tidak dapat diterjemahkan dengan baik, kerana mengimbau bererti menghadirkan kejadian lepas kepada masa sekarang. Ini hanya dapat dizahirkan dengan menggunakan fiil mudhari' yang digandingkan dengan **كان** sebelumnya.

Data 4:

Waktu itu umur Datuk Jalal Akbar **sudah hampir** empat puluh tahun (hlm 40)

Terjemahan Sultan	Terjemahan Google
في تلك الأيام كان داتوُ جلال أكبر يقارب الأربعين	في ذلك الوقت ، كان داتوك جلال أكبر يبلغ من العمر أربعين عامًا تقريبًا

Ulasan:

Kedua-dua terjemahan seharusnya menggunakan frasa **كان قد فعل** memandangkan terdapat penggunaan kata bantu aspek 'sudah'.

كان يفعل (dulu selalu)

Data 1

Dia merasa bahagia mendengar hujah Siti Nuriza. Itulah yang **ditunggu-tunggunya** (hlm 15-16)

Terjemahan Sultan	Terjemahan Google
شعر بالفرح على احتجاج سيّتي نور عزة، فهذا ما كان ينتظره منها	شعر بالسعادة لسماع حجة سيّتي نوريزا. هذا ما كان ينتظره

Ulasan:

Kedua-dua terjemahan menggunakan frasa **كان يفعل**. Ini bertepatan dengan makna 'dulu selalu' yang terkandung dalam frasa tersebut. Ini melihat kepada makna 'kekerapan' yang terkandung dalam pengandaian kata kerja "tertunggu-tunggu".

Data 2:

Selalunya ketika kakak membongkok tangan ustaz terlindung...itulah yang **selalu Sayuti lihat** (hlm 200)

Terjemahan Sultan	Terjemahan Google
حينما تسلم وتنحني فيد الاستاذ تكون محجوبة عن نظري... هذا الذي كنت أراه كثيرا	عادة عندما تنحني الأخت تكون يد الأستاذ محمية ... هذا ما يراه Sayuti دائما

Ulasan:

Terjemahan Sultan menggunakan frasa كان يفعل dengan baik bagi menjelaskan perihal kekerapan pada waktu lepas. Makna ini dikuatkan lagi dengan perkataan كثيرا selepasnya. Manakala terjemahan Google tidak berjaya menghasilkan maka ini kerana tidak menggunakan kata kerja كان, sedangkan konteks dengan jelas merujuk waktu lepas (شعر).

كاد يفعل

Data 1

Siti Nuriza **hampir-hampir menampar** adiknya itu (hlm 37)

Terjemahan Sultan	Terjemahan Google
كادت سיתי نور عزة أن تصفع أختها على وجهه	كادت سיתי نوريزا أن تصفع أختها

Ulasan:

Secara umumnya, kedua-dua terjemahan menggunakan frasa yang tepat iaitu كاد diikuti fiil mudhari', namun ia kurang tepat kerana menurut penggunaan yang standard, kata kerja كاد tidak menerima أن selepasnya.

Data 2

Pada suatu masa **hampir-hampir terjerumus** ke dalam perangkap nafsu orang lain (hlm 114)

Terjemahan Sultan	Terjemahan Google
وفي يوم من الأيام كادت أن تقع في مكيدة شهوة شخص غريب	في وقت ما كاد يقع في فخ شهوة الآخرين

Ulasan:

Seperti data sebelumnya, kedua-dua terjemahan menggunakan frasa كاد + يفعل tetapi didapati penggunaan terjemahan Google lebih menepati kaedah asal iaitu tidak menggunakan كاد selepas أن.

بدأ يفعل

Didapati bahawa terjemahan Sultan menggunakan frasa بدأ يفعل ketika menterjemahkan frasa kerja 'mula+kata kerja'. Terjemahan Google juga menggunakan terjemahan yang sama, Cuma ia juga menggunakan frasa مصدر + بدأ + مصدر dan مصدر + ب + مصدر, contohnya:

Data 1

Dia hanya melihat seorang yang seakan-akan hancur...**mula membangun** dan berdiri dengan gagah (hlm 43)

Terjemahan Sultan	Terjemahan Google
يرى مجرد إنسانة هي على وشك الهلاك... بدأت تصحو وتقف بشجاعة	لم ير سوى رجلاً بدا وكأنه محطم... بدأ في البناء والوقوف بشجاعة

Data 2

Siti Nuriza sudah mula terkesan dengan ajaran-ajaran yang diberikan (hlm 64)

Terjemahan Sultan	Terjemahan Google
سيتي نور عزة بدأت تتأثر بما يقدم لها	بدأت سيتي نوريزا في الإعجاب بالتعاليم المقدمة

Data 3

Jamal Akbar mula memujuk adiknya (hlm 198)

Terjemahan Sultan	Terjemahan Google
بدأ جمال أكبر يسترضي أخاه	بدأ جمال أكبر في إقناع أخته

Data 4

Dia hanya seorang yang dijemput untuk membetulkan keadaan kerohanian sebuah keluarga. Dan keluarga itu sudah mulai pulih (ms 218)

Terjemahan Sultan	Terjemahan Google
فإنه مجرد شخص دعي لأن يعالج...الوضع الروحاني في أسرة من الأسر، وقد بدأت هذه الأسرة تتعافى	إنه مجرد شخص مدعو لإصلاح الحالة الروحية للعائلة. وبدأت الأسرة في التعافي

Data 5

Kakaknya mula membuka sebuah gelanggang untuk suatu perlawanan yang tidak pernah terselesai (ms 256)

Terjemahan Sultan	Terjemahan Google
بدأت أخته تفتح ميدانا لمباريات ليس لها نهاية	بدأت أخته في فتح حلقة لمباراة لم تنتهي أبداً

Ulasan:

Dari data-data yang dipaparkan jelas menunjukkan bahawa terjemahan Google menggantikan frasa بدأ dengan المصدر + في + المصدر + يفعل yang merupakan penggunaan moden bagi menjelaskan makna hampir bagi kejadian, tindakan atau keadaan.

Selain itu, terjemahan Google turut menggandingkan kata kerja يفعل dengan kata sendi ب. Ini dapat diperhatikan pada data-data berikut:

Data 1

Saya dah mula merisik Ustaz Saifuddin supaya dapat mengajar hukum-hakam secara betul-betul dalam rumah ini (hlm 60)

Terjemahan Sultan	Terjemahan Google
أنا بدأت أترقب الأستاذ سيف الدين كي يأتي ويدرس الأحكام بشكل صحيح	لقد بدأت بالتجسس على الأستاذ سيف الدين حتى أتمكن من تدريس القوانين بشكل صحيح في هذا المنزل

Data 2

“Yalah,” kakaknya mulai menurun. Tersenyum melihat adiknya yang tersenyum tenang ke arahnya (hlm 256)

Terjemahan Sultan	Terjemahan Google
"حقيقة"، بدأت أخته تهاداً وتبتسم لما رأت أباها وهو أيضا يبتسم لها	نعم ، "بدأت أخته بالنزول. يبتسم لأخته التي تبتسم له بهدوء

Ulasan:

Melalui data-data ini didapati bahawa terjemahan Sultan kerap menggunakan frasa بدأ يفعل , manakala terjemahan Googole lebih kerap menggunakan frasa

بدأ + ب / في + مصدر

DAPATAN DAN KESIMPULAN

1. Usaha pengkaji bahasa Arab moden membahaskan tajuk frasa kata kerja dari sudut aspek dan masa membantu penuntut bahasa Arab menggunakan kata kerja dengan lebih baik.
2. Terdapat beberapa perbezaan antara terjemahan manusia (Sultan) dan terjemahan mesin (Google) dalam menterjemah beberapa frasa. Terjemahan manusia didapati lebih menepati makna yang dibawa oleh teks sumber iaitu bahasa Melayu. Namun, ini tidak menafikan kualiti yang dihasilkan oleh terjemahan Google.
3. Dari sudut kemampuan terjemahan Google Translate dalam menzahirkan perujukan masa dari bahasa Melayu yang berbeza cara perujukannya, data-data yang dianalisa menunjukkan bahawa terjemahan Google mampu memahami penggunaan كان meskipun ia tidak mempunyai padanan yang jelas dalam bahasa Melayu seperti frasa كان يفعل dan كان قد فعل. Ini membuktikan bahawa terjemahan Google dalam beberapa keadaan mampu memahami perujukan masa.
4. Namun, dapatan ini tidak bermakna bahawa terjemahan Google standing dengan manusia. Bagi meningkatkan lagi mutu terjemahan, pengkaji menyeru pengguna memasukkan cadangan-cadangan pembetulan supaya sistem Google dapat memahami makna melalui gabungan frasa yang dimasukkan.

BIBLIOGRAFI

- Abdul Hamid, Ashafizrol. (2016). *Binaan Ayat Bahasa Arab*. Kuala Lumpur: Alasfiyaa Sdn. Bhd.
- Arifatun, N. (2012). *Kesalahan penerjemahan teks bahasa Indonesia ke bahasa Arab melalui Google Translate (Studi analisis sintaksis)*. Lisanul Arab: Journal of Arabic Learning and Teaching, 1(1).
- Baharun, M. N. A. S., & Abdullah, N. (2011). *Kesilapan Terjemahan Bahasa Arab-Bahasa Melayu dalam Ejen Carian Google: Satu Kajian Semantik*. Persidangan Penterjemahan Antarabangsa ke-13. Anjuran Persatuan Penterjemah Malaysia.
- Lawa, S. T. N., Ate, C. P., & Feka, V. P. (2022). *Penggunaan Google Translate Sebagai Alternatif Media Penerjemah Pada Abstrak Jurnal Mahasiswa*. HINEF: Jurnal Rumpun Ilmu Pendidikan, 1(1), 86-93.
- Hasan, T. (1994). *Al-Lughat Al-'Arabiyyat Ma'nāha Wa Mabnāha*. Casablanca: Dār Al-Thaqāfa.
- Kendrigan, S. (2014). *Studi Kasus: Masalah Terjemahan Terkait Dengan Ekspresi, Frasa Biasa Dan Frasa Idiomatik*.
- Makhzūmī, M. (1986). *Fi an-Nahwu al-Arabi Naqdun wa Taujihun*. Cet. 2. Beirut: Dar ar-Ra'id al-Arabi.

- Sa'diyah, Z. (2014). *Tipologi kesalahan kebahasaan dan keakuratan hasil terjemahan Google Translate teks bahasa Indonesia ke dalam bahasa Arab*. Arabia: Jurnal Pendidikan Bahasa Arab, 6 (2).
- Al-Sāmurrāī, F.S. (2017). *Ma'āni Al-Nahw*. Cet. 1. Beirut: Dār Ibn Kathīr
- Sjahrony, K., & Ahmad, M. (2013). *Penterjemahan Frasa Al-Idafah Arab-Melayu Menggunakan Google Translate*. Islamiyyat: International Journal of Islamic Studies, 35(2).
- S. Othman Kelantan,(1991). *Ustaz*. Bandar Baru Bangi: Citra Publishing Sdn. Bhd
- Stanovsky, G., Smith, N. A., & Zettlemoyer, L. (2019). *Evaluating gender bias in machine translation*. arXiv preprint arXiv:1906.00591.



UNIVERSITI
MALAYSIA
KELANTAN

Strategi Dalam Memperkasakan Pedagogi Terbeza Dalam Kalangan Guru Pendidikan Islam

Muhammad Amirul Syazwan bin Borhanordin
Fakulti Pendidikan, Universiti Kebangsaan Malaysia (UKM)
p111225@siswa.ukm.edu.my

Isa bin Hamzah
Fakulti Pendidikan, Universiti Kebangsaan Malaysia (UKM)
isa_hamzah@ukm.edu.my

ABSTRAK

Matlamat mata pelajaran Pendidikan Islam diharapkan dapat membentuk murid yang berilmu, beriman dan beramal soleh untuk mencapai keredaan Allah. Namun begitu, usaha tersebut tidak akan tercapai jika guru tidak peka terhadap kepelbagaian murid di dalam kelas. Guru yang menyedari kepelbagaian yang wujud dalam kalangan muridnya merupakan salah satu faktor proses pengajaran itu berkesan. Oleh itu, dalam Pelan Pembangunan Pendidikan Malaysia (PPPM) gelombang kedua 2016-2020, Pedagogi Terbeza ini menjadi sebagai salah satu pendekatan yang dapat memberi tumpuan kepada kepelbagaian murid di dalam kelas bagi membolehkan murid belajar berdasarkan potensi serta persekitaran mereka. Justeru itu, kertas konsep ini akan membincangkan strategi dalam memperkasakan Pedagogi Terbeza dalam kalangan guru Pendidikan Islam. Antara aspek penting yang perlu diberi penekanan ialah pengetahuan isi kandungan, pengetahuan pedagogi, pengetahuan guru tentang kepelbagaian murid serta pengetahuan kurikulum. Diharapkan perbincangan kertas kerja ini dapat memberi impak yang positif kepada beberapa perkara penting seperti memperbaiki amalan pengajaran Pendidikan Islam dan memberikan panduan serta pendedahan kepada guru tentang penerapan Pedagogi Terbeza dalam pengajaran dan pembelajaran di bilik darjah. Seterusnya, kajian ini juga diharapkan dapat menyumbang kepada peningkatan profesionalisme guru Pendidikan Islam di bawah Kementerian Pendidikan Malaysia melalui latihan berfokus kepada pengajaran Pedagogi Terbeza.

Kata kunci: *Pedagogi Terbeza; guru Pendidikan Islam; strategi; kepelbagaian murid*

PENGENALAN

Sistem pembelajaran Malaysia sangat menekankan terhadap kepelbagaian aras pemikiran dan kognitif murid di dalam bilik darjah. Hal ini kerana semua murid mempunyai tahap kognitif yang berbeza. Banyak kaedah pengajaran yang telah diperkenalkan bagi meraikan perbezaan individu di dalam kelas. Perbezaan individu memberi makna ketidaksamaan seseorang sama ada dari segi sifat emosi kognitif, tingkah laku, fizikal, bakat, moral, sosial atau dan aspek-aspek yang lain yang berkaitan (Abd. Khahar bin Sapranı et.al 2018). Menurut Zamri, Ruslin dan Mohamed Amin (2015) guru perlu mengambil kira perbezaan yang ada dalam kalangan murid semasa proses pengajaran. Hal ini kerana, murid yang lemah akan tercicir dalam pembelajaran dan natijahnya objektif pengajaran tidak akan tercapai. Di samping itu, seseorang guru dapat mengaplikasikan kaedah pengajaran yang bersesuaian apabila mengambil kira perbezaan individu di dalam bilik darjah. Lantaran itu, setiap guru perlu sentiasa kompeten terhadap kebelbagaian murid di dalam kelas dengan menggunakan kaedah pengajaran yang berkesan bagi mencapai tujuan kualiti Pengajaran dan Pemudahcaraan (PdPc) dalam bilik darjah. Justeru itu, perancangan guru dalam PdPc perlulah dilaksanakan secara teliti untuk memperoleh proses pengajaran yang bermakna.

Malaysia telah melalui beberapa fasa perubahan terutamanya dalam pendidikan bermula dari era sebelum merdeka, semasa merdeka dan masa kini. Justeru, terdapat beberapa pendekatan diperkenalkan oleh Kementerian Pendidikan Malaysia (KPM) untuk dijadikan panduan oleh guru-guru bagi menjadikan proses pengajaran lebih bermakna dan berimpak tinggi. Julismah Jani et.al (2009) menyatakan bahawa pendekatan pengajaran merujuk kepada bagaimana guru itu menguruskan pengajaran, menggunakan teknik pengajaran dan kandungan pengetahuan guru bagi menjalankan satu proses pengajaran dan pembelajaran yang lengkap.

Bagi mencapai keberkesanan dan kejayaan tujuan pendidikan, pendekatan pengajaran wajar dilaksanakan dengan efisien bagi mengenal pasti penguasaan, kemahiran dan pengamalan murid. Justeru, guru perlu mempunyai kemahiran dalam menyelesaikan sesuatu masalah terhadap muridnya. Hal ini amat bertepatan dengan tanggungjawab guru yang sebenar iaitu sebagai ejen perubahan dalam memberi ilmu pengetahuan terhadap murid. Tambahan pula, guru Pendidikan Islam (GPI) merupakan ejen perubahan keperibadian murid (Nur Aida Muhammad & Mohd Aderi Che Noh, 2014) dan penerapan penghayatan Islam bukan hanya menitik beratkan aspek ilmu pengetahuan sahaja (Ab Halim et al. 2012). Sehubungan dengan itu, kertas konsep ini akan membincangkan berkenaan Justeru, kertas konsep ini diharap dapat merumuskan satu cadangan kerangka amalan pendekatan Pedagogi Terbeza yang dapat menjadi panduan oleh guru Pendidikan Islam bagi menambah baik proses pelaksanaan pengajaran dan pentaksiran di dalam bilik darjah.

KAJIAN LEPAS

Matlamat mata pelajaran Pendidikan Islam diharapkan agar dapat membentuk murid yang syumul daripada segi intelek, kerohanian, jasmani bertujuan untuk mencapai keredaan Allah. Namun begitu, usaha tersebut tidak akan tercapai jika guru tidak menyampaikan ilmu dan pengetahuan dengan baik terhadap kepelbagaian murid di dalam kelas. Antara cabaran utama yang dihadapi dalam melaksanakan pedagogi terbeza ini ialah masalah kefahaman serta pengetahuan guru. Guru Pendidikan Islam (GPI) perlu mempunyai pengetahuan tentang ilmu isi kandungan, ilmu pedagogi dan ilmu pentaksiran agar semua murid dapat dibina mengikut acuan yang betul sesuai dengan pertumbuhan dan perkembangan mereka. Namun, kajian-kajian lepas mendapati guru masih kurang memahami keperluan serta matlamat pelaksanaan pendekatan Pedagogi Terbeza di dalam bilik darjah. Ini kerana terdapat guru-guru yang masih tidak melaksanakan di dalam bilik darjah (Daniel Arif Abdul Muttalip, 2020) dan tidak jelas tentang konsep Pedagogi Terbeza (Nuraishahtun et al. , 2019). Zaidir Zainal Abidin & Kamisah Osman (2017) menyatakan ilmu pengetahuan merupakan indikator utama dalam mempersiapkan para guru dalam mendidik anak murid untuk berusaha menyelesaikan masalah. Justeru, guru akan mengaplikasikan pengetahuan yang dimiliki serta menggunakan strategi pembelajaran yang sesuai untuk murid agar mereka mampu menguasai kemahiran PdPc.

Seterusnya, Pedagogi Terbeza memerlukan guru memahami serta mendapat pendedahan yang jelas berkenaan proses pengajaran yang akan dirancang agar mereka bersedia menjalankan proses PdPc. Namun, kesediaan guru dalam melaksanakan Pedagogi terbeza menjadi satu isu. Terdapat beberapa faktor yang boleh menjadi punca kepada masalah yang dihadapi oleh murid sehingga menyebabkan mereka gagal menguasai kemahiran asas pendidikan Islam dan boleh berpunca daripada guru itu sendiri. Menurut Kama et al., (2019), terdapat sebilangan guru yang tidak mahir dalam memberi bimbingan kepada murid untuk belajar dalam suasana bilik darjah yang kondusif dan bermakna. Hal ini dijelaskan Zainuddin & Nor Hisham (2011) yang menyatakan guru perlu bijak menggunakan pelbagai kaedah yang bersesuaian mengikut minat dan kemampuan murid.

Terdapat juga kalangan warga pendidik yang tidak bersungguh dan bersedia dalam PdPc serta tidak cakna dalam keperluan pedagogi (Nurahimah Mohd Yusof et al., 2017). Roslan (2016) dalam kajiannya telah menyatakan bahawa faktor guru boleh menjadi punca kepada isu yang dihadapi oleh murid iaitu disebabkan oleh kurangnya kreativiti, inovasi, pengetahuan dan pendekatan guru yang tidak sesuai. Faktor lain yang boleh menjadi punca kepada masalah yang dihadapi oleh murid boleh disebabkan oleh kaedah pengajaran secara keseluruhan di dalam kelas oleh guru (Mohd Asnorhisham 2014). Oleh itu, perkembangan murid yang berbeza tahap kognitif ini amatlah bergantung pada kesediaan dan keupayaan guru untuk mewujudkan suasana kelas yang kondusif dan perancangan PdPc yang berkesan.

Seterusnya, isu kepelbagaian murid ini memerlukan guru memiliki sikap yang sabar semasa mengajar murid secara berulang kali mengajar isi pengajaran yang sama. Pengajaran perlu dilaksanakan secara berulang kali bagi membolehkan murid menguasai isi pembelajaran (Noraini dan Musliha 2018). Karakter serta tingkah laku yang berbeza di dalam kelas juga boleh menjadi faktor menyukarkan guru dalam mengawal murid ini. Ini dinyatakan dalam kajian Nurhijrah Zakaria et al. (2020) ;Tengku Sarina Aini Tengku Kasim dan Fatimah Sahida Abdurajak (2018) ; dan Daniel Arif Abdul Muttalip (2020) yang menunjukkan guru sukar untuk mengajar kerana perlu berhadapan dengan murid yang mempunyai latar belakang yang berbeza di dalam kelas. Situasi yang berlaku ini menyebabkan guru perlu merancang aktiviti yang berbeza sesuai mengikut tahap dan kebolehan murid dan ada masanya guru akan mengambil lebih banyak masa untuk mengajar murid yang lemah sehingga menyebabkan objektif pembelajaran tidak tercapai.

Bagi memastikan pembelajaran yang berlangsung berjalan dengan lebih berkesan dan berkualiti, seorang guru Pendidikan Islam itu perlulah kreatif semasa merancang PdP agar proses pembelajaran menjadi bermakna. Untuk mengajar murid yang datang daripada kepelbagaian tahap pemikiran, guru perlulah memiliki kecekapan, pengetahuan, sentiasa bermotivasi dan mengamalkan PdP yang berkesan (Roslan 2016). Kajian Zamri et.al (2015) mendapati semasa menjalankan Pedagogi Terbeza, guru perlu cakna terhadap beberapa aspek utama seperti kesediaan murid, minat dan peribadi pembelajaran dengan mengambil kira aspek utama dalam Pedagogi Terbeza. Sehubungan dengan itu, pengajaran guru perlu ditingkatkan kerana dalam Noraini (2015) menyatakan keberkesanan pengajaran dan pembelajaran Pendidikan Islam adalah bergantung kepada keupayaan guru GPI itu sendiri.

Namun, kajian terdahulu mendapati bahawa terdapat beberapa kelemahan guru dalam menerapkan elemen pedagogi terbeza ini di dalam kelas. Hal ini kerana masih terdapat guru yang tidak cakna berkenaan kaedah pengajaran yang digunakan. Pernyataan ini jelas dengan dapatan kajian Mohd Asnorhisham Adam & Abdul Rahim Bin Hamdan (2017) yang menyatakan guru menyediakan rancangan pengajaran harian tidak mengikut aras kemampuan murid. Fenomena ini memberi kesan kepada murid iaitu murid yang pelbagai aras sukar untuk memahami apa yang diajar guru. Menurut Norliza Mat Ali (2016), kebanyakan guru masih mengamalkan pengajaran berpusatkan guru, menggunakan cara lama, yang kurang merangsang aktiviti pembelajaran murid. Terdapat guru yang mengajar menggunakan kaedah syarahan semata-mata dan mengabaikan kaedah yang bersesuaian dengan kepelbagaian murid di dalam kelas (Cathrine Masingan dan Sabariah Sharif, 2019). Berbeza dengan kajian Ain Nur Atika Agus (2021) yang mendapati bahawa guru memiliki tahap pengetahuan kurikulum dan kesediaan yang tinggi semasa melaksanakan Pedagogi Terbeza semasa sesi Pengajaran dan Pembelajaran di Rumah (PdPR).

KONSEP PEDAGOGI TERBEZA

Pedagogi Terbeza merupakan satu pendekatan pengajaran yang memerlukan guru berperanan dalam membuat pengubahsuaian kepada kurikulum, kaedah pengajaran, bahan pengajaran, aktiviti pengajaran dan hasil murid untuk memenuhi keperluan dan kepelbagaian murid dalam proses pembelajaran (Halida dan Zamri 2021). Berasaskan pendapat Mazura & Wak Chu (2018), Pedagogi Terbeza ialah proses menyesuaikan kandungan dan kaedah pengajaran berdasarkan kesediaan, gaya pembelajaran dan minat murid. Pedagogi Terbeza juga ditakrifkan sebagai sesuatu kaedah pengajaran yang memerlukan guru merancang pengajaran, pendekatan, sumber, aktiviti dan hasil yang proaktif bagi memaksimumkan pembelajaran setiap murid. Pedagogi terbeza juga adalah salah satu cara pemikiran mengenai pengajaran dan pembelajaran (Tomlinson dan Imbeau 2010). Konsep pengajaran Pedagogi Terbeza digambarkan dalam rajah 1 di bawah:

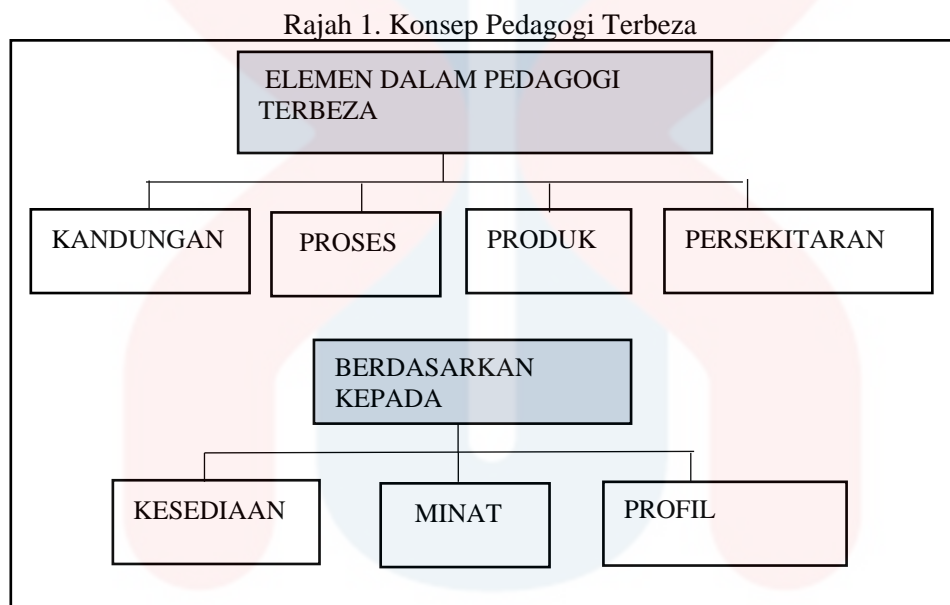

Sumber: Tomlinson (2014)

Berdasarkan model Pedagogi Terbeza pada rajah 1, Pedagogi Terbeza terdiri daripada empat elemen utama iaitu isi kandungan, proses, hasil dan persekitaran. Setiap elemen ini perlu dipenuhi bagi memenuhi pembelajaran murid supaya pembelajaran yang dialami murid akan mendapat hasil yang diharapkan. Pedagogi Terbeza adalah satu pendekatan yang digunakan bagi memenuhi keperluan pembelajaran murid kerana wujudnya kepelbagaian individu, kepelbagaian budaya persekitaran, kepelbagaian daya kognitif dan kepelbagaian minat dan motivasi untuk belajar (Abd Khahar et al. 2018).

MEMPERKASAKAN PEDAGOGI TERBEZA

Dalam menghasilkan guru Pendidikan Islam yang prihatin kepada kepelbagaian murid di dalam kelas, penulis berpendapat empat aspek berikut perlu dikuasai oleh setiap guru Pendidikan Islam. Shulman (1987) yang memperkenalkan empat konsep *Pedagogical Content Knowledge* atau Pengetahuan Pedagogi Kandungan (PPK) jika mahu menghasilkan guru yang cemerlang, berkesan, inovatif dan kreatif dalam pengajaran dan pembelajaran. Hal ini sewajarnya diikuti dan diamalkan oleh guru, termasuk guru-guru Pendidikan Islam.

Apakah yang dimaksudkan dengan PPK? Shulman (1987) mendefinisikan PPK kepada pengetahuan guru menterjemahkan pengetahuan isi kandungan secara pedagogikal yang berkesan

dengan memahami konteks dalam persekitaran pembelajaran di dalam bilik darjah berdasarkan pengetahuan guru terhadap pengetahuan isi kandungan subjek, pengetahuan pedagogi subjek, pengetahuan ciri setiap muridnya, pengetahuan tentang kepercayaan terhadap pendekatan pengajaran dan pembelajaran yang digunakan. PPK banyak melibatkan cara penyampaian guru secara berkesan terhadap sesuatu idea, analogi kukuh, ilustrasi menarik, contoh-contoh tepat dan munasabah, penerangan jelas dan bermakna serta tunjuk cara berkesan agar sesuatu isi pelajaran itu dapat difahami murid dengan mudah.

Bagaimanakah penggunaan PPK dapat memperkasa Pedagogi Terbeza kepada guru-guru Pendidikan Islam? PPK dapat memperkasa pengajaran guru Pendidikan Islam dari segi membimbing murid untuk memahami mata pelajaran Pendidikan Islam dengan lebih bermakna seperti dengan penggunaan bahasa yang mudah difahami, pertuturan yang lancar dan sistematik, perwatakan yang ceria dan meyakinkan ketika kelas Pendidikan Islam, penjelasan topik yang disusun, diolah, diubah suai dan disampaikan berdasarkan pelbagai kebolehan murid (Magdeline & Zamri 2016). Dengan adanya PPK ini, guru-guru Pendidikan Islam dapat menyampaikan isi pengajaran dengan lebih mudah dan berkesan. Guru-guru Pendidikan Islam dalam abad ke-21 perlu mempunyai tahap pengetahuan isi kandungan Pendidikan Islam yang baik. Perkembangan terkini dalam kurikulum pendidikan Pendidikan Islam sewajar diketahui oleh setiap guru. Antara pengetahuan isi kandungan Pendidikan Islam yang perlu difokuskan ialah:

Pengetahuan Isi Kandungan

Guru-guru Pendidikan Islam dalam abad ke-21 perlu mempunyai tahap pengetahuan isi kandungan Pendidikan Islam yang baik. Perkembangan terkini dalam kurikulum pendidikan Pendidikan Islam sewajar diketahui oleh setiap guru. Antara pengetahuan isi kandungan Pendidikan Islam yang perlu difokuskan ialah:

1. Kesediaan guru Pendidikan Islam untuk menyampaikan bahan pengajaran merupakan perkara terpenting dalam pengendalian sesi pengajaran dan pembelajaran. Hal ini bermakna pengetahuan guru Pendidikan Islam tentang isi kandungan Pendidikan Islam merupakan kesediaan terpenting untuk memastikan keberkesanan pengajarannya.
2. Penguasaan ilmu, iaitu setiap guru Pendidikan Islam perlu menguasai ilmu pedagogi Pendidikan Islam. Pengetahuan isi kandungan subjek yang berkaitan dengan sukatan, sama ada secara langsung atau tidak secara langsung merupakan faktor penentu kefahaman murid terhadap apa yang diajarkan oleh guru Pendidikan Islam berkenaan. Hal ini bermakna tanpa menguasai ilmu Pendidikan Islam, boleh mengganggu pemahaman dan pengetahuan murid tentang tajuk yang dipelajari.

Rumusannya, tahap keberkesanan pengajaran guru Pendidikan Islam banyak bergantung kepada pengetahuan isi kandungan subjek dan kemampuan guru mengurus masa untuk dimanfaatkan sepenuhnya dalam pengajaran. Pengetahuan isi kandungan Pendidikan Islam yang baik juga membantu guru merancang pengajaran harian, mingguan dan bulanan secara sistematik dan bertulis.

Pengetahuan Pedagogi

Pengetahuan pedagogi mengajar bermaksud setiap guru perlu mempunyai pelbagai pengetahuan berkaitan pedagogi mengajar. Dalam konteks pendidikan Pendidikan Islam, setiap guru Pendidikan Islam sewajarnya memahami dan menguasai pelbagai kemahiran pedagogi terkini yang melibatkan kaedah, pendekatan, teknik dan strategi mengajar. Antara pedagogi yang perlu dikuasai oleh guru Pendidikan Islam ialah Pedagogi Terbeza ini. Oleh itu, sebelum

guru menjalankan Pedagogi Terbeza sama ada membezakan daripada segi kandungan, proses dan produk, beberapa langkah atau fasa dalam Pedagogi Terbeza perlulah dirangka dan dirancang. Terdapat enam fasa utama dalam kitaran reka bentuk Pedagogi Terbeza yang boleh dilaksanakan dalam pengajaran Pendidikan Islam iaitu, fasa pertama: menganalisis, fasa kedua: merancang pengajaran, fasa ketiga: mereka bentuk pengajaran, fasa keempat: melaksanakan Pedagogi Terbeza, fasa kelima: pemantauan dan pentaksiran dan fasa keenam: penilaian.

Fasa pertama: menganalisis.

Guru perlu menganalisis dengan mengenali, memahami dan menilai murid terlebih dahulu bagi mengetahui kehendak dan keperluan murid dalam pembelajaran Pendidikan Islam dengan membahagikan kepada tiga kumpulan yang berbeza iaitu kumpulan pandai, kumpulan sederhana dan kumpulan lemah. Guru mengubah suai kandungan pelajaran mengikut kesediaan murid, minat dan profil pembelajaran.

Fasa kedua: merancang pengajaran

Fasa ini melibatkan perancangan guru terhadap kandungan pembelajaran berdasarkan kurikulum standard dengan menerangkan secara jelas kata kunci dan idea-idea utama yang memberi makna mengikut tajuk pelajaran. Guru mempelbagaikan kaedah pengajaran, sumber dan aktiviti pengajaran seperti secara individu, berpasangan, kumpulan atau dalam kumpulan. Guru mempelbagaikan soalan berdasarkan keupayaan murid. Guru memastikan perkembangan pembelajaran murid secara berterusan berdasarkan peningkatan penguasaan murid.

Fasa ketiga: mereka bentuk pengajaran

Guru merancang strategi dan kaedah pengajaran serta cara penilaian ke atas murid mengikut kesesuaian dan keperluan serta kebolehan murid. Peranan strategi pengajaran adalah lebih penting lagi jika kita mengajar murid yang berbeza dari segi kebolehan, pencapaian, kecenderungan serta minat yang berbeza-beza. Kita perlu rancang pendekatan dan kaedah yang digunakan untuk mengajar kumpulan-kumpulan yang berbeza-beza itu. Contohnya, di dalam bilik darjah yang pelbagai tahap pencapaian, guru perlu memikirkan strategi pengajaran yang terdiri daripada pelbagai kaedah mengajar untuk memenuhi keperluan semua kumpulan.

Fasa keempat: melaksanakan pengajaran terbeza

Guru perlu membina proses pengajaran dan pembelajaran dengan memenuhi keperluan pelbagai murid dengan melibatkan pemikiran yang kritis dan kreatif (Hapsah & Abd Khahar, 2018). Guru juga perlu menyusun atur persekitaran bilik darjah yang kondusif bagi menarik minat murid belajar dan mewujudkan interaksi sosial yang baik.

Fasa kelima: pemantauan dan pentaksiran

Guru perlu memantau secara berterusan penglibatan dan perkembangan pembelajaran murid.

Fasa keenam: penilaian

Guru mempelbagai kaedah penilaian berdasarkan bahan pembelajaran yang diberikan mengikut kecenderungan. Murid boleh memilih pelbagai cara untuk menunjukkan hasil pemahaman mereka seperti penulisan, persembahan, projek dan lain-lain. Guru menganalisis

data dan penilaian pengajaran bagi menambah baik pengajaran pada kitaran seterusnya (Zurina, Zaharah & Ab. Muhsien, 2020).

Pengetahuan Guru tentang Kepelbagaian Murid

Guru yang baik ialah seorang guru yang bukan sahaja mempunyai kepelbagaian kemahiran mengajar, tetapi juga mempunyai pengetahuan yang mendalam terhadap setiap anak murid yang di dalam kelas yang diajarnya. Pengetahuan berkaitan ciri murid adalah amat diperlukan untuk membantu guru memilih pendekatan, kaedah dan teknik pengajaran dan pembelajaran yang sesuai dengan setiap ciri muridnya (Zamri, 2015). Oleh itu, Pedagogi Terbeza sangat menekankan pengetahuan guru tentang ciri muridnya boleh menjadikan pengajaran guru yang lebih bermakna dan meninggalkan kesan positif dalam diri murid berkenaan. Dalam konteks Pedagogi Terbeza dalam pengajaran dan pembelajaran Pendidikan Islam, pengetahuan guru tentang murid-muridnya dilihat dari aspek berikut:

Pengetahuan tentang tahap kognitif murid

Setiap murid adalah berbeza tahap kognitifnya. Demikian juga murid yang belajar Pendidikan Islam. Tahap Oleh itu, guru-guru Pendidikan Islam perlu memahami setiap muridnya itu berbeza tahap kognitifnya. Sudah tentu apabila menyoal (aras soalan), memberi tugas (mudah atau sukar), memberi arahan main peranan (sebagai ketua, pembentang, pencatat) dan sebagainya, maka guru-guru Pendidikan Islam perlu mengambil keupayaan murid tersebut untuk menjawab soalan, menyiapkan tugas, kemampuan bertindak ketika main peranan dan sebagainya.

Pengetahuan tentang tahap sosioemosi murid

Kemampuan murid mempelajari Pendidikan Islam juga ada kaitan dengannya dengan tahap sosioemosi murid. Dalam hal ini, guru-guru Pendidikan Islam perlu kreatif dalam merancang aktiviti pengajaran dan pembelajarannya. Guru Pendidikan Islam perlu kira bahawa tahap sosioemosi murid boleh mempengaruhi sesi pengajaran dan pembelajaran secara keseluruhannya.

Pengetahuan tentang sikap murid

Faktor sikap amat penting dalam menentukan sama ada seseorang murid itu berminat atau tidak berminat mempelajari sesuatu mata pelajaran itu, guru yang mengajar, kaedah pengajaran yang digunakan dan sebagainya. Justeru, setiap guru Pendidikan Islam perlu memastikan pengajarannya menyeronokkan, dan mudah difahami murid. Kreativiti dan inovatif guru ketika mengajar boleh mempengaruhi sikap murid terhadap mata pelajaran Pendidikan Islam.

Rumusannya, pengetahuan yang mendalam tentang setiap murid amat penting bagi setiap guru Pendidikan Islam. Pengetahuan yang baik tentang murid-muridnya membolehkan guru Pendidikan Islam menyalurkan semua pengetahuan isi kandungan dan pengetahuan pedagogi kandungan dapat diterapkan secara penyebatian.

Pengetahuan Kurikulum

Pengetahuan kurikulum bermaksud guru-guru Pendidikan Islam perlu memahami, mengetahui dan menguasai bagaimana kurikulum Pendidikan Islam itu dibina dan direka bentuk menjadi satu kurikulum yang sesuai untuk tahap kognitif murid. Antara elemen dalam pengetahuan

kurikulum Pendidikan Islam itu ialah guru-guru perlu memiliki pengetahuan bagaimana hendak melaksanakan pengajaran Pendidikan Islam dengan menyeluruh untuk membolehkan guru-guru membuat perancangan dan pelaksanaan pengajarannya mengikut tahap perkembangan dan kematangan murid. Apabila guru Pendidikan Islam memahami pelaksanaan kurikulum Pendidikan Islam tersebut, maka guru-guru dapat merancang pelaksanaan kurikulum Pendidikan Islam secara menyeluruh. Hal ini penting diketahui dan dikuasai setiap guru agar pelaksanaan kurikulum Pendidikan Islam yang dibuat dapat disesuaikan dengan keperluan dan tuntutan semasa seperti keperluan kemahiran abad ke-21.

Rumusannya, Pengetahuan Pedagogi Kandungan (PPK) perlu dikuasai oleh setiap guru Pendidikan Islam. Perubahan-perubahan yang berlaku dalam sistem pendidikan masa kini banyak mencabar keupayaan dan kebolehan guru Pendidikan Islam untuk mengajar dengan baik dan berkesan. Keadaan ini ditambah pula dengan kepelbagaian yang wujud dalam kalangan muridnya. Oleh itu, guru-guru Pendidikan Islam perlu bersedia dan lebih terkehadapan dalam banyak perkara agar proses pengajarannya menjadi lebih menarik dan menyeronokkan murid. Kaitan PPK guru-guru Pendidikan Islam ini boleh diperjelaskan seperti Rajah 2.

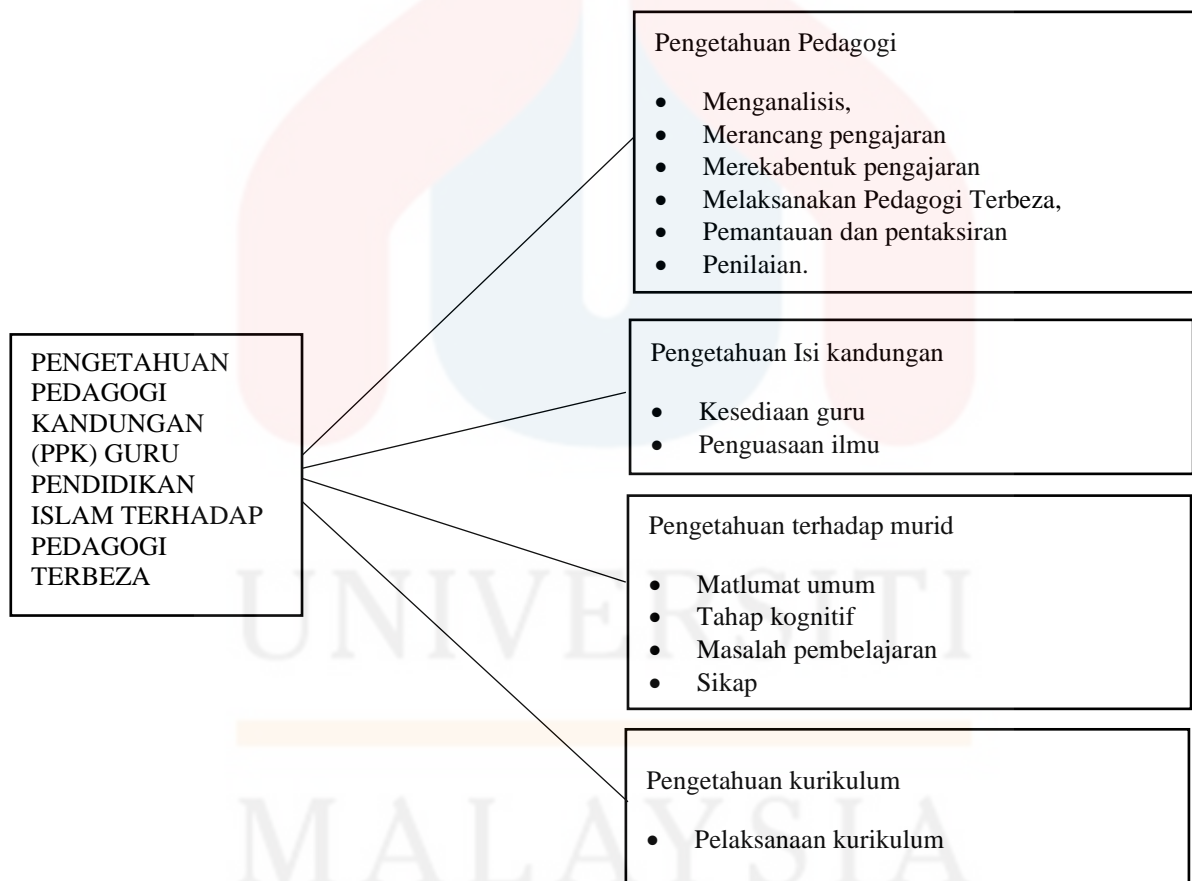

Rajah 2. PPK yang perlu ada pada guru Pendidikan Islam terhadap Pedagogi Terbeza

STRATEGI DALAM MEMPERKASAKAN PEDAGOGI TERBEZA

Seperti yang dibincangkan di atas, setiap guru perlulah cakna serta mempunyai kemahiran dalam pedagogi yang dilaksanakan di dalam kelas. Berikut diberikan beberapa cadangan untuk menambah baik pengajaran guru berfokuskan kepada amalan Pedagogi Terbeza:

Pembentukan Sikap Positif Guru

Sikap guru memainkan peranan penting dalam memastikan pelaksanaan pendidikan dijalankan selari dengan aspirasi sistem pendidikan. Guru diibaratkan sebagai nyawa kepada KPM kerana guru yang tidak berkualiti akan menjejaskan keseluruhan bidang pendidikan termasuklah murid-murid (Roqib et al, 2020). Kesedaran dan penerimaan guru-guru tentang kepentingan pelaksanaan dan impak Pedagogi Terbeza ini terhadap murid akan membawa kejayaan dalam pelaksanaan. Hal ini dibuktikan dengan pendapat Aniza Ahmad & Zamri Mahamod (2015) yang menyatakan bahawa guru-guru perlu menerima perubahan transformasi pendidikan dengan hati yang terbuka dan bersedia untuk meningkatkan ilmu pengetahuan.

Latihan dan pendidikan berkaitan Pedagogi Terbeza

Dalam memperkasakan kompetensi guru Muslim dalam Pedagogi Terbeza, latihan dan kursus yang berkala perlulah dilaksanakan bagi memberi input berkaitan ilmu pengetahuan, kemahiran, dasar dan utusan dari pihak-pihak berkaitan. Latihan dan kursus yang dihadiri kebiasaannya terdiri daripada kursus dan latihan yang dianjurkan oleh pihak sekolah, Pegawai Pendidikan Daerah (PPD), Jabatan Pendidikan Negeri (JPN) dan Kementerian Pendidikan Malaysia (KPM). Namun begitu, terdapat beberapa kelemahan yang perlu diatasi agar latihan dan kursus yang dihadiri memberi impak yang besar kepada guru. Kursus dan latihan perlu diperkasakan lagi dengan memperbanyakkan lagi kursus-kursus yang berkaitan secara komprehensif dan berkala (Ravikumar K. Varatharaj, 2015). Hal ini diperlukan bagi menyediakan ilmu-ilmu yang diperlukan oleh guru-guru bagi meningkatkan lagi kompetensi mereka dalam bidang Pendidikan era semasa terutama dalam Pedagogi Terbeza.

Pengukuhan awal di Institusi Peguruan

Institusi yang bertanggungjawab melatih guru-guru perlu memastikan latihan dan pendidikan yang diterima oleh bakal-bakal guru ini memenuhi kriteria atau standard yang ditetapkan terutama berkaitan dengan ilmu pedagogi dalam pendidikan. Hal ini bagi memastikan guru-guru di sekolah sentiasa bersedia terhadap kaedah pedagogi yang bersesuaian dengan tahap kefahaman murid di dalam kelas.

Pembangunan profesionalisme berterusan (Continuing profesional development-CPD) guru Pendidikan Islam

Guru-guru Pendidikan Islam hendaklah sentiasa dihantar mengikuti kursus, bengkel, seminar, galakkan membuat sangkutan (attachment), lawatan sambil belajar dan sebagainya terutama dalam Pedagogi Terbeza sebagai satu kaedah peningkatan CPD guru-guru Pendidikan Islam. Pendedahan berterusan CPD penting dalam melahirkan guru-guru Pendidikan Islam yang sentiasa menerima idea-idea baharu, kreatif dan inovatif yang dapat diaplikasikan dalam pengajaran dan pembelajaran di dalam bilik darjah.

Pemantauan dan Penyeliaan

Pemantauan dan penyeliaan dari pihak-pihak tertentu samada pemantauan dalaman atau luaran perlu dijalankan bagi memastikan segala dasar yang diturunkan ke sekolah dijalankan dan tidak lari dari paksinya. Pemantauan ini lebih bersifat kunjung bantu yang mana pihak pemantau duduk bersama-sama guru bagi membincangkan permasalahan yang timbul dan membuat penambahbaikan dengan kadar segera sekiranya berlaku kesilapan di mana-mana bahagian.

Sekiranya pemantauan dan penyeliaan secara kunjung bantu dijalankan secara berterusan dan konsisten, guru-guru akan lebih mendapat tempat rujukan dan bimbingan serta kaedah yang terbaik dalam menyelesaikan segala masalah yang berlaku di sekolah seterusnya dapat meningkatkan kualiti kegunaan itu sendiri.

KESIMPULAN

Daripada perbincangan yang dirungkaikan dalam kertas kerja ini, Pedagogi Terbeza bukanlah sesuatu pendekatan yang baharu, namun demikian pengetahuan guru terhadap pendekatan ini masih terbatas dan kurang menjadi amalan para pendidik. Oleh sebab itu, guru Pendidikan Islam perlulah memainkan peranan yang penting dalam melengkapkan keperluan murid yang pelbagai seiring dengan kemahiran yang diperlukan dalam pembelajaran abad ke-21 (PAK-21) bagi melahirkan generasi yang berpengetahuan tinggi, berfikiran kritis, mempunyai kepimpinan dan mampu untuk berkomunikasi dengan berkesan. Penggunaan pendekatan Pedagogi Terbeza boleh dijadikan asas dalam pengajaran Pendidikan Islam sehingga ke tahap pembelajaran yang lebih bermakna (deep learning). Aspek-aspek penting dalam Pedagogi Terbeza yang melibatkan minat, gaya pembelajaran, kebolehan dan kemahiran murid perlu dipertimbangkan dalam proses pemilihan isi kandungan pembelajaran, aktiviti pembelajaran, bahan pembelajaran dan pengajaran serta penilaian untuk pembelajaran bagi setiap murid. Justeru itu, GPI perlu mengambil peranan untuk melaksanakan Pedagogi Terbeza ini dalam pembelajaran dan pengajaran agar matlamat Pendidikan Islam dapat disematkan dalam diri murid-murid dengan meraikan kepelbagaian individu.

RUJUKAN

- Ab Halim Tamuri, Muhamad Faiz Ismail dan Kamarul Azmi Jasmi. 2012. Komponen asas untuk latihan guru Pendidikan Islam. *Global Journal At-Thaqafah*, Vol.2(2).
- Abd. Khahar bin Saprani, Hapsah binti Majid, Zanariah binti Ibrahim, & Lokman bin Abd Wahid. 2018. Pedagogi terbeza : Keadilan dalam proses pengajaran dan pembelajaran. *Jurnal Penyelidikan Pendidikan*, 11, 1–17.
- Ain Nur Atika Agus. 2021. Tahap pengetahuan dan kesediaan guru Bahasa Melayu dalam melaksanakan pendekatan terbeza dalam pengajaran dan pembelajaran di rumah sesame tempoh perintah kawalan pergerakan. *Jurnal Pendidikan Bahasa Melayu – JPBM (Malay Language Education Journal – MyLEJ)*. 11(1), 75-87.
- Aniza Ahmad & Zamri Mahamod. (2015). Tahap kemahiran guru bahasa melayu sekolah menengah dalam melaksanakan Pentaksiran Berasaskan Sekolah berdasarkan jantina, opsyen dan tempat mengajar. *Jurnal Pendidikan Bahasa Melayu*, 5 (1), 18-29.
- Cathrine Masingan, & Sabariah Sharif. 2019. Pengetahuan Pedagogi Kandungan (PPK) Guru Bukan Pengkhususan Reka Bentuk dan Teknologi (RBT) di Sekolah Menengah. *Malaysian Journal of Social Sciences and Humanities (MJ - SSH)*, 4(6), 64–71.
- Daniel Arif Abdul Muttalip. 2020. Pelaksanaan pendekatan pengajaran terbeza dalam kalangan guru Bahasa Melayu yang mengajar di sekolah rendah pedalaman Kategori 3. *Jurnal Pendidikan Bahasa Melayu*, 10(November), 29–42.
- Hapsah Majid & Abd. Khahar Saprani. 2018. Penggunaan Bahan Sastera dalam Pengajaran dan Pembelajaran melalui Pedagogi Terbeza. *Seminar Pedagogi Alternatif Kesusasteraan Melayu (SPAKEM) 2018*. IPG Kampus Bahasa Melayu, KL.
- Julismah Jani, Ong Kuan Boon, Mohd Sani Madon, Hishamuddin Ahmad, Nur Haziyanti Mohamad Khalid, Yusof ahmad. 2009. Pendekatan Pengajaran, Gaya Belajar dan Jenis Penilaian dalam Mata Pelajaran Sains Sukan di Sekolah Menengah. *Jurnal Pendidikan Malaysia*, 34 (2) 81-91.

- Kama Shaffeei, Abdul Rahim Razalli, Shamsul Rizal Khalil. 2019. Tahap Amalan Pengajaran Guru Pendidikan Khas di Malaysia. Seminar Amalan Terbaik PdPc Pendidikan Khas Peringkat Negeri Selangor. Universiti Pendidikan Selangor (UNISEL), 20-21 Ogos.
- Magdeline anak Nor & Zamri Mahamod (2016). Pengetahuan pedagogi kandungan guru bahasa Iban. Bangi: Penerbit Universiti Kebangsaan Malaysia.
- Mazura Sulaiman & Wak Chu Wok. 2018. Tinjauan tentang Pengetahuan dan Penerimaan terhadap Pengajaran Terbeza dalam Kalangan Siswa Pendidik Program Ijazah Sarjana Muda Perguruan. Prosiding Seminar Kebangsaan Majlis Dekan Pendidikan Universiti Awam 2018. IPG Kampus Bahasa Melayu, Kuala Lumpur.
- Mohd Asnorhisham Adam & Abdul Rahim Bin Hamdan. 2017. Pendekatan pengajaran secara berkumpulan dalam Program Pemulihan Khas Bahasa Melayu. *Jurnal Pendidikan Bahasa Melayu*, 7(1), 66-73.
- Mohd Asnorhisham Adam. 2014. Kompetensi GPK terhadap pengajaran secara berkumpulan dalam program pemulihan khas di sekolah kebangsaan, Johor. *Kertas Kerja dibentang dalam Konvensyen Kebangsaan Pendidikan Guru 2014*.
- Noraini Omar & Musliha Ismail. 2018. Kemahiran Berfikir Aras Tinggi Dalam Pengajaran Dan Pembelajaran Berfokuskan Kepelbagaian Budaya Murid Sekolah Rendah (Kssr). *Proceeding 5th International Conference On Research In Islamic Education and Arabic Language (ICRIALE 2018)*.
- Noraini Omar. 2015. Amalan Pengajaran Guru Pendidikan Islam Berfokuskan Kepelbagaian Budaya : Kajian Kes di Sarawak. Tesis Doktor Falsafah. Fakulti Pendidikan. UKM. Bangi.
- Norliza Mat Ali. 2016. Tahap kesediaan guru bahasa Melayu terhadap pelaksanaan pendekatan pembelajaran berasaskan masalah dalam pengajaran dan pembelajaran di Selangor, Malaysia. *Master Dissertation: Universiti Putra Malaysia*.
- Nur Aida Muhammad & Mohd Aderi Che Noh. 2014. Penerapan Kemahiran Berfikir Aras Tinggi (KBAT) dalam Pengajaran dan Pembelajaran Pendidikan Islam Sekolah Rendah. *Prosiding Wacana Pendidikan Islam Siri Ke-10*, hlm. 520-541.
- Nurahimah Mohd Yusof, Mohd Izam Ghazali, & Mohd Isha Awang. 2017. Amalan pedagogi berpusatkan pelajar dan masalah yang dihadapi guru-guru pelatih program pensiswazahan guru untuk mengamalkan pedagogi berpusatkan pelajar semasa praktikum. *Proceedings of the ICECRS*, 1(1), 599–608.
- Nuraishahtun Md Akhir, Zamri Mahamod, Siti Faraziah Md Akib & Norshiha Hj Sailon. 2019. Pelaksanaan modul pedagogi terbeza Sekolah Agama Bantuan Kerajaan (SABK) dalam pengajaran dan pembelajaran Bahasa Melayu. *Prosiding Seminar Kebangsaan Pendidikan Negara (SKEPEN) Ke-6*. Fakulti Pendidikan, Universiti Kebangsaan Malaysia, 21-22 September.
- Nurhijrah Zakaria, Zuria Mahmud, Mohd Mahzan Awang, Mohd Izham Mohd Hamzah, Ruhizan Mohamad Yasin, & Ramlee Mustapha. 2020. Pedagogi responsif budaya dalam pengajaran Sejarah untuk persekitaran pembelajaran bilik darjah pelbagai budaya. *Jurnal Penyelidikan Pendidikan*, March.
- Ravikumar K. Varatharaj. (2015). Amalan pentaksiran dalam PdP Kurikulum Standard Sekolah Rendah (KSSR) di Sekolah Kluster. *Jurnal Penyelidikan Dedikasi*, 9,1-17.
- Roqib, Mohammad & Nurfuadi. (2020). *Kepribadian guru*. Yogyakarta: Creative Commons Attribution.
- Roslan Chin. 2016. Amalan pengajaran guru, masalah penguasaan kemahiran Bahasa dan strategi pembelajaran Bahasa dalam kalangan murid pemulihan. *Phd Dissertation. Universiti Utara Malaysia*.
- Shulman, L. 1987. Knowledge and teaching: Foundation of new reform. *Havard Educational Review*, 57 (1): 1-22.

- Tengku Sarina Aini Tengku Kasim, & Fatimah Sahida Abdurajak. 2018. Pengalaman pengajaran guru novis pendidikan Islam : Implikasi terhadap reka bentuk kurikulum latihan pendidikan guru. *Jurnal Pendidikan Malaysia*, 43(1), 59–66.
- Tomlinson & Imbeau, M. 2010. *Leading And Managing a Differentiated Classroom*. Alexandria, VA: ASCD.
- Zaidir Zainal Abidin & Kamisah Osman. 2017. Tahap pengetahuan, pemahaman, kemahiran dan pelaksanaan guru sains terhadap kemahiran berfikir aras tinggi (KBAT) Fakulti Pendidikan, Universiti Kebangsaan Malaysia : Bangi Selangor.
- Zainuddin Abu Bakar & Nor Hisham Muhamad Nor. 2011. Pendekatan pengajaran guru dan kesannya terhadap pencapaian pelajar dalam mata pelajaran Kemahiran Hidup di sekolah menengah kebangsaan Senai, Johor. *Journal of Technical, Vocational & Engineering Education*, 2, 106-118.
- Zamri Mahamod, Ruslin Amir & Mohamed Amin Embi. 2015. *Kepelbagaian Murid dan Perbezaan Pembelajaran*. Kuala Lumpur: Dewan Bahasa dan Pustaka.
- Zamri Mahamod, Ruslin Amir & Mohamed Amin Embi. 2015. *Kepelbagaian Murid dan Perbezaan Pembelajaran*. Kuala Lumpur: Dewan Bahasa dan Pustaka.
- Zurina Mustaffa, Zaharah Hussin & Abdul Muhsien Sulaiman. 2020. Pedagogi Terbeza Untuk Pengajaran Guru Terhadap Kepelbagaian Murid. *Malaysian Journal of Social Sciences and Humanities (MJSSH)*, 6(9), 202 – 214.

Penerimaan Pelajar Tahfiz Terhadap Program Latihan Kemahiran di Kolej Komuniti

Mohd Rashidi Omar

Pensyarah, Kolej Komuniti Chenderoh, 33000 Kuala Kangsar, Perak
shidi_omar@yahoo.com

Siti Nasuha Singki

Pensyarah, Universiti Malaysia Sarawak, 94300 Kota Samarahan, Sarawak

Basuriah Yunus

Pensyarah, Kolej Komuniti Chenderoh, 33000 Kuala Kangsar, Perak

ABSTRACT

The community college offers Lifelong Islamic Education (PISH) Courses under the Lifelong Learning (PSH) unit where emphasis is also given to tahfiz students as participants who follow the Skills Training Program (PLK). This study was conducted to identify the level of acceptance of tahfiz students towards skills training programs in Community Colleges. The data collection method for this survey was conducted by asking respondents to fill in a questionnaire online. The total sample collected was 70 people, involving all tahfiz students who followed the skills training program under the lifelong Islamic education course at Chenderoh Community College, Kuala Kangsar Community College and Sungai Siput Community College. The main analysis technique used is descriptive which involves percentage value, mean value and level of interpretation, while each question item is evaluated by respondent using a five point Likert type answer scale that is through the level of "Strongly Agree" to "Strongly Disagree". In addition, inferential analysis using T-test was also conducted to answer the hypotheses in this study. The results of the study showed that the overall question items on the level of acceptance of tahfiz students towards the skills training program in community colleges were at a high level of interpretation with a mean value (mean = 4.21). Meanwhile, the findings for the analysis of differences showed that the hypothesis was accepted and this showed that there was no significant difference in the level of acceptance of tahfiz students towards the skills training program based on gender. Thus, it can be concluded here that the skills training program offered by the community college received positive feedback from tahfiz students where such programs can help this group improve their ability in daily life, even this program is also suitable for tahfiz students whether male or female.

Keywords: *Community College, Lifelong Islamic Education, Skills Training Programs*

ABSTRAK

Kolej komuniti menawarkan Kursus Pendidikan Islam Sepanjang Hayat (PISH) di bawah unit Pembelajaran Sepanjang Hayat (PSH) di mana penekanan turut diberikan kepada pelajar tahfiz sebagai peserta yang mengikuti Program Latihan Kemahiran (PLK). Kajian ini dijalankan bagi mengenal pasti tahap penerimaan pelajar tahfiz terhadap program latihan kemahiran di kolej komuniti. Kaedah pungutan data bagi kajian tinjauan yang dilakukan adalah melalui pengisian borang soal selidik yang dikongsi kepada responden secara atas talian. Jumlah sampel yang dikumpul adalah seramai 70 orang iaitu melibatkan semua pelajar tahfiz yang mengikuti program latihan kemahiran di bawah kursus pendidikan Islam sepanjang hayat di Kolej Komuniti Chenderoh, Kolej Komuniti Kuala Kangsar dan Kolej Komuniti Sungai Siput. Teknik analisis utama yang digunakan adalah secara deskriptif iaitu melibatkan nilai peratusan, nilai min dan tahap interpretasi, manakala setiap item soalan dinilai oleh responden menggunakan skala jawapan jenis Likert lima mata iaitu melalui tahap

“Sangat Setuju” kepada “Sangat Tidak Setuju”. Selain itu, analisis inferensi menggunakan Ujian T turut dijalankan bagi menjawab hipotesis dalam kajian ini. Hasil dapatan kajian menunjukkan keseluruhan item soalan tahap penerimaan pelajar tahfiz terhadap program latihan kemahiran di Kolej Komuniti berada pada tahap interpretasi yang tinggi dengan nilai min ($\text{min}=4.21$). Manakala, dapatan bagi analisis perbezaan menunjukkan hipotesis diterima dan ini menunjukkan tidak terdapat perbezaan yang signifikan tahap penerimaan pelajar tahfiz terhadap program latihan kemahiran berdasarkan jantina. Justeru, dapat disimpulkan di sini bahawa program latihan kemahiran yang ditawarkan oleh Kolej Komuniti mendapat maklum balas penerimaan yang positif daripada pelajar tahfiz di mana program sebegini dapat membantu golongan ini meningkatkan tahap kemahiran diri dalam menjalani kehidupan seharian, bahkan program ini juga sesuai untuk disertai oleh pelajar tahfiz samaada lelaki mahupun perempuan.

Kata Kunci: Kolej Komuniti, Pendidikan Islam Sepanjang Hayat, Program Latihan Kemahiran

PENDAHULUAN

Jabatan Pendidikan Kolej Komuniti (JPKK) telah ditubuhkan bagi menyediakan keperluan latihan dan kemahiran kepada semua peringkat usia dan memberi peluang pendidikan kepada lepasan menengah sebelum ke pasaran tenaga kerja atau melanjutkan pendidikan ke peringkat lebih tinggi. Sebanyak 10 buah kolej komuniti rintis mula beroperasi pada pertengahan Jun 2001 dan 2 buah lagi pada bulan Disember 2001 (Jabatan Pendidikan Kolej Komuniti, 2017a). Sehingga ke hari ini, terdapat 104 buah kolej komuniti yang telah beroperasi di seluruh negara.

Kolej komuniti telah menawarkan program secara sepenuh masa dan jangka masa pendek. Kursus jangka masa pendek merupakan kursus yang dirancang bagi memenuhi permintaan komuniti. Hal ini bertujuan bagi menggalakkan pembelajaran sepanjang hayat disamping dapat menambahkan kemahiran dan menjana pendapatan tambahan isi rumah. Pada tahun 2013, pihak Jabatan Politeknik dan Kolej Komuniti (JPPKK) telah memperkenalkan satu program dibawah pembelajaran sepanjang hayat iaitu Pendidikan Islam Sepanjang Hayat (PISH). PISH adalah salah satu inisiatif yang diperkenalkan bagi membuka satu landasan ke arah peningkatan kerjaya, pengukuhan ilmu dan pemupukan nilai kepada umat Islam sejagat. Oleh itu, cadangan telah dikemukakan oleh Menteri Pendidikan Malaysia pada Disember 2013 untuk meletakkan PISH sebagai sebuah dasar negara.

Pendidikan Islam sepanjang hayat merupakan sebahagian daripada elemen pembelajaran sepanjang hayat yang merupakan satu inisiatif untuk menggabungkan latihan kemahiran dan pendidikan agama ke arah pembentukan masyarakat yang berilmu, beriman, bertakwa dan mempunyai nilai insani demi kesejahteraan dalam kehidupan di dunia dan akhirat (Kementerian Pendidikan Tinggi, 2017). Menurut Yufiza et al. (2016) kolej komuniti telah dipilih sebagai penggerak utama bagi program PISH yang menggabungkan aspek kemahiran dan pendidikan agama. Selain itu, PISH juga bertujuan menggalakkan masyarakat Malaysia terutama mereka yang tidak berkesempatan mendapat peluang pendidikan agama atau kemahiran secara formal untuk meneruskan usaha mendapatkan ilmu dan kemahiran tanpa mengira had umur dan bidang pekerjaan. Ini juga adalah sebahagian daripada usaha memperkukuh modal insan dan meningkatkan kualiti kehidupan masyarakat dalam jangka masa panjang. PISH yang berkonsepkan pendidikan duniawi dan ukhrawi dalam pelaksanaannya terbahagi kepada tiga kategori yang menjadi asas kepada pelaksanaannya di kolej komuniti iaitu seperti berikut:

- i. Pendidikan ukhrawi iaitu Pendidikan Islam yang berterusan kepada setiap lapisan masyarakat.
- ii. Pendidikan duniawi iaitu memberikan ilmu kemahiran dan keusahawanan kepada pelajar tahfiz, pelajar sekolah pondok, pelajar maahad dan institusi agama Islam yang lain.
- iii. Kombinasi pendidikan ukhrawi dan duniawi yang dilaksanakan atas permintaan institusi, agensi dan komuniti setempat (Noraina et al., t.t)

Justeru itu, kajian ini akan memfokuskan kepada program latihan kemahiran iaitu merujuk kepada kategori kedua iaitu pelaksanaan pendidikan Islam sepanjang hayat yang melibatkan golongan sasaran seperti pelajar tahfiz sebagai peserta yang mengikuti program latihan kemahiran di bawah Kolej Komuniti.

PROGRAM LATIHAN KEMAHIRAN KOLEJ KOMUNITI

Program latihan kemahiran di kolej komuniti merupakan antara program yang ditawarkan di bawah unit Pembelajaran Sepanjang Hayat di Kolej Komuniti. Unit Pembelajaran Sepanjang Hayat adalah sebuah unit yang akan memberi peluang kepada pembangunan profesional dalam masyarakat dan individu. Oleh hal yang sedemikian, penyediaan kepada program latihan kemahiran di bawah unit ini adalah merupakan salah satu daripada objektif pelaksanaan pembelajaran sepanjang hayat iaitu dengan menyediakan latihan bagi meningkatkan kemahiran (*up-skilling*) dan melatih semula (*re-skilling*) untuk keperluan tenaga kerja setempat (Noraina et al., t.t). Penganjuran di bawah unit pembelajaran sepanjang hayat ini mempunyai 21 kluster kursus pendek yang dilaksanakan di kolej komuniti antaranya akuakultur, bahasa, bangunan, elektrik dan elektronik, grafik dan multimedia, hospitaliti dan pelancongan, jahitan dan pakaian, kecantikan dan dandanan, kenderaan dan automotif, kerohanian dan keagamaan, kesenian dan kebudayaan, komputer dan teknologi maklumat, kraftangan dan hiasan dalaman, pembangunan diri dan motivasi, perniagaan dan keusahawanan, program industri, sains dan matematik, sains kesihatan, seni kreatif, teknologi agro dan teknologi hijau (Kementerian Pendidikan Tinggi, 2017). Kesemua program latihan kemahiran yang ditawarkan ini bertujuan untuk membantu memberi pendidikan terbaik kepada golongan yang telah disasarkan.

Pemilihan peserta yang mengikuti program latihan kemahiran yang ditawarkan oleh kolej komuniti adalah berdasarkan kepada pecahan kategori di bawah unit pembelajaran sepanjang hayat. Secara umumnya, tiada limitasi peserta yang layak menyertai program latihan kemahiran ini. Dalam erti kata lain, program ini adalah ditawarkan kepada semua golongan masyarakat seperti pelajar sekolah menengah, pelajar tahfiz atau pondok, pelajar lepasan sekolah atau institusi pengajian tinggi, orang kelainan upaya, belia, warga emas, suri rumah, pekerja industri, ahli kumpulan profesional, eksekutif mahupun pengurus, warga institusi pendidikan, warga jabatan dan agensi kerajaan, ahli badan bukan kerajaan (NGO) dan banyak lagi.

Pelaksanaan program latihan kemahiran di kolej komuniti juga bergantung kepada fokus kategori program yang dijalankan seperti kursus pembelajaran sepanjang hayat bermodular, kursus revolusi industri 4.0, kursus pendidikan Islam sepanjang hayat dan lain-lain lagi. Hal ini bermaksud, program latihan kemahiran ini ditawarkan kepada masyarakat mengikut kategori yang telah ditetapkan di bawah unit pembelajaran sepanjang hayat di Kolej Komuniti. Pembahagian yang dilakukan ini adalah bertujuan bagi memudahkan pelaksanaan program atau kursus-kursus yang ditawarkan kepada semua golongan masyarakat.

Namun demikian, fokus kepada kajian yang dijalankan ini adalah lebih kepada Program Latihan Kemahiran yang telah dilaksanakan dibawah kategori pendidikan Islam sepanjang

hayat iaitu merujuk sasaran kepada pelajar tahfiz, pelajar sekolah pondok, pelajar maahad dan institusi agama Islam yang lain yang pernah mengikuti kursus-kursus latihan kemahiran dan keusahawanan yang dianjurkan di kolej komuniti sebelum ini.

PERNYATAAN MASALAH

Terdapat beberapa tinjauan yang dijalankan bagi mengenal pasti isu-isu yang berkaitan dengan program latihan kemahiran dan pendidikan Islam sepanjang hayat. Menurut Nornazlina et al. (t.t), kesedaran golongan sasaran terutamanya belia, pelajar maahad, sekolah pondok dan tahfiz terhadap program latihan kemahiran masih berada pada tahap yang rendah. Selain daripada meluaskan lagi skop pengajaran dan pembelajaran bagi program latihan kemahiran ini, pendedahan yang berterusan berkaitan program di bawah pendidikan Islam sepanjang hayat sangat penting bagi memberi peluang kepada mereka untuk mendapatkan sijil kemahiran di samping menjadi tauliah bagi pelajar tahfiz mengurus kelansungan hidup. Hal ini demikian kerana, sehingga kini, tidak ada data yang jelas berkaitan jumlah pelajar tahfiz yang betul-betul menyertai program latihan kemahiran yang dianjurkan oleh pihak Kolej Komuniti. Justeru itu, jumlah mahupun kekerapan pelajar tahfiz yang mengikuti program latihan kemahiran ini akan diteliti menerusi kajian yang akan dijalankan ini.

Selain itu, kekangan yang dihadapi oleh sesetengah institusi tahfiz terutamanya bagi institusi tahfiz swasta yang tidak mempunyai kemudahan peralatan latihan yang lengkap bahkan kos pentadbiran juga meningkat menyebabkan institusi tersebut terus berada dalam keadaan serba kekurangan (Solahuddin, 2016). Nornazlina et al. (t.t) turut mengatakan bahawa kekangan dalam aspek sumber kewangan yang terhad juga merupakan halangan kepada golongan sasaran ini sukar untuk melibatkan diri daripada menyertai program pendidikan Islam sepanjang hayat. Perkara ini juga perlu untuk ditelusuri semula bagi menggalakkan penyertaan dan manfaat dapat dikongsi pada lebih ramai pelajar tahfiz.

Seterusnya, Suriyana et al. (2017) mengatakan bahawa penekanan perlu diberikan kepada tenaga pengajar selari dengan kepelbagaian permintaan kursus serta kualiti penyampaian dan kandungan kursus yang diberikan menerusi latihan yang berterusan. Nurul Huda (t.t), turut berpendapat bahawa kemudahan dan perkhidmatan di Kolej Komuniti merupakan antara satu faktor yang perlu untuk dititikberatkan oleh pihak Kolej Komuniti kerana ianya turut mempengaruhi tahap kepuasan peserta yang terlibat dalam pelaksanaan kursus-kursus yang dianjurkan. Kolej komuniti bertanggungjawab menyediakan kemudahan pembelajaran yang lengkap dan tenaga pengajar yang berkebolehan agar dapat melaksanakan program Pembelajaran Sepanjang Hayat (PSH) yang berkesan (Hazwani & Nor Aishah, 2018).

Kejayaan sebenar sesuatu program adalah apabila peserta dapat memanfaatkan ilmu yang dipelajari. Namun demikian, perkara sebaliknya berlaku apabila pelatih-pelatih yang telah mempunyai kemahiran dan pengetahuan hasil daripada latihan yang diberikan masih tidak dapat mengaplikasikan latihan tersebut dalam kehidupan (Hamidah & Rozeyta, 2009). Perkara ini sangat membimbangkan kerana sepatutnya latihan yang sistematik dan berterusan akan dapat meningkatkan kecekapan, keberkesanan tugas dan peluang menambah ekonomi dalam kehidupan seharian (Abdul Ghafar Don, 2015). Hal ini menimbulkan keraguan terhadap penganjuran kursus dan keberkesanan program latihan kemahiran yang dilaksanakan. Perkara sebegini perlu dielakkan kerana faktor latihan yang diterima merupakan antara perkara penting dalam menentukan keberkesanan dalam sesuatu pekerjaan (Khairunneezam, 2004).

Tinjauan terhadap kajian berkaitan pelaksanaan Pendidikan Islam Sepanjang Hayat di Universiti Sains Islam Malaysia (USIM) oleh Zulkiple et al. (2015) memperlihatkan secara jelas cabaran utama pelaksanaan pendidikan Islam sepanjang hayat di USIM. Hasil daripada kajian tersebut mendapati sukar untuk memperkenalkan pakej pembelajaran yang sesuai dengan kehendak sasaran apatah lagi yang dapat mengartikulasi antara *niche* USIM dalam mengintegrasikan ilmu naqli dan aqli dan tempat kerja, komuniti, status sosio ekonomi serta aspek perkembangan dan penggunaan teknologi. Oleh hal yang sedemikian, bagi mempertingkatkan kualiti penyampaian dan pengajaran dan pembelajaran yang dianjurkan oleh Kolej komuniti, pihak kolej perlu melihat pandangan dan persepsi peserta yang mengikuti kursus pendidikan Islam sepanjang hayat terhadap keberkesanan pelaksanaan kursus dari aspek maklumat kursus, kaedah penyampaian, kelengkapan peralatan dan faedah keseluruhan kursus (Nor Azida Mansor et al., 2015).

Tidak dinafikan bahawa program latihan kemahiran bagi pendidikan Islam sepanjang hayat di kolej komuniti telah menarik minat dan perhatian golongan sasaran sejak diperkenalkan pada awal tahun 2014. Namun begitu, isu berkaitan pengiktirafan dan jaminan kualiti, kurikulum dan penaksiran, infrastruktur dan kemudahan, promosi dan sokongan serta pengantarabangsaan bagi program pendidikan Islam sepanjang hayat di kolej komuniti dan institut pengajian tinggi tidak terlepas untuk dipersoalkan oleh sebahagian individu (Kementerian Pendidikan Tinggi, 2017). Hal ini demikian kerana, penawaran bagi pelaksanaan kursus pendidikan Islam sepanjang hayat di kolej komuniti adalah berbentuk kursus jangka masa pendek yang tempohnya tidak melebihi enam bulan dan tempoh pelaksanaan yang minima hanyalah lima jam. Statistik daripada Jabatan Perangkaan Malaysia 2017 juga mendapati jumlah graduan berkemahiran tinggi di kolej komuniti masih kecil kerana kebanyakannya tidak mencapai tahap kemahiran dan pengetahuan yang diingini industri. Kekurangan tenaga mahir ini menyebabkan pengeluaran produktiviti negara rendah serta mewujudkan jurang besar dengan negara maju (Hazwani & Nor Aishah, 2018). Lantaran itu, tahap penerimaan peserta terhadap setiap penganjuran program latihan kemahiran bagi pelajar tahfiz perlu untuk dikenal pasti supaya keberkesanan sesuatu program dapat dilihat dengan lebih jelas.

OBJEKTIF KAJIAN

1. Mengetahui kekerapan pelajar tahfiz yang menyertai kursus di kolej komuniti.
2. Mengetahui tahap penerimaan pelajar tahfiz terhadap program latihan kemahiran di kolej komuniti.
3. Mengetahui perbezaan tahap penerimaan pelajar tahfiz terhadap program latihan kemahiran di kolej komuniti berdasarkan jantina.

PERSOALAN KAJIAN

1. Berapakah kekerapan pelajar tahfiz yang menyertai kursus di kolej komuniti?
2. Apakah tahap penerimaan pelajar tahfiz terhadap program latihan kemahiran di kolej komuniti?
3. Sejauh manakah perbezaan tahap penerimaan pelajar tahfiz terhadap program latihan kemahiran di kolej komuniti berdasarkan jantina?

HIPOTESIS KAJIAN

H₀₁ Tidak terdapat perbezaan yang signifikan antara tahap penerimaan pelajar tahfiz terhadap program latihan kemahiran berdasarkan jantina.

METODOLOGI KAJIAN

Kajian ini menggunakan reka bentuk kajian kuantitatif melalui kajian tinjauan bagi mendapatkan data kuantitatif. Kajian tinjauan dilakukan dengan pengumpulan data secara atas talian melalui borang soal selidik yang bertajuk 'Tahap Penerimaan Pelajar Tahfiz terhadap Program Latihan Kemahiran di Kolej Komuniti'. Pemilihan menggunakan soal selidik adalah disebabkan soal selidik akan lebih mudah untuk ditadbir serta mudah untuk dilakukan penganalisan jawapan (Mohd Majid, 2005). Format soal selidik bagi kajian ini terbahagi kepada dua bahagian iaitu, Bahagian A (Demografi Responden), dan Bahagian B (Tahap Penerimaan Program Latihan Kemahiran). Item-item dibentuk berpandukan adaptasi daripada kajian-kajian lepas. Kajian ini dijalankan di tiga buah kolej komuniti dalam daerah Kuala Kangsar di negeri Perak. Pemilihan kolej komuniti ini adalah kerana negeri Perak mencatatkan jumlah bilangan kolej komuniti yang terbanyak di Malaysia iaitu 13 buah kolej komuniti. Manakala daerah Kuala Kangsar pula mempunyai jumlah kolej komuniti paling banyak dalam negeri Perak. Oleh itu, kajian ini melibatkan tiga kolej komuniti yang terdapat dalam daerah Kuala Kangsar iaitu Kolej Komuniti Chenderoh, Kolej Komuniti Sungai Siput dan Kolej Komuniti Kuala Kangsar. Maka, sepanjang kajian ini dijalankan hanya tiga buah kolej komuniti sahaja yang terlibat bagi menilai tahap penerimaan pelajar tahfiz terhadap program latihan kemahiran. Manakala, Responden yang terlibat dalam kajian ini adalah terdiri daripada pelajar tahfiz yang melibatkan seramai 70 orang peserta yang telah mengikuti Program Latihan Kemahiran di tiga buah Kolej Komuniti tersebut.

Pemungutan data bagi soal selidik yang digunakan adalah menerusi skala jawapan jenis Likert lima mata bagi pilihan jawapan kepada responden. Hasil dapatan dari soal selidik tersebut dianalisis menggunakan perisian *Statistical Package for the Social Science (SPSS) version 26* bagi melihat tahap penerimaan pelajar tahfiz terhadap program latihan kemahiran di kolej komuniti.

Dalam kajian ini, analisis perangkaan yang digunakan ialah analisis deskriptif dan analisis inferensi dengan menggunakan perisian *SPSS* bagi memudahkan pengkaji untuk mengetahui kerelevanan dan signifikan jawapan yang diberikan oleh responden. Analisis deskriptif digunakan untuk menghuraikan latar belakang responden menerusi soal selidik tinjauan yang meliputi jantina, tempat tinggal dan kekerapan menyertai kursus. Statistik yang digunakan adalah kekerapan dan peratus. Analisis deskriptif juga digunakan untuk menghuraikan dapatan kajian berkaitan tahap penerimaan pelajar tahfiz terhadap program latihan kemahiran di kolej komuniti. Statistik yang digunakan bagi pelaporan data adalah peratusan, min, dan interpretasi min, manakala bagi tahap penilaian responden akan dihuraikan mengikut nilai min yang diperolehi iaitu tahap tinggi seharusnya berada dalam lingkungan 3.67 – 5.00, sederhana dalam lingkungan 2.34 – 3.66, dan tahap penilaian rendah akan menunjukkan keputusan nilai min pada lingkungan 0.00 – 2.33. Penghuraian bagi data tahap penilaian nilai min adalah merujuk kepada skor yang telah diubahsuai daripada Mohd Najib (2006).

Satu analisis inferensi bagi melihat perbezaan yang wujud di antara dua pemboleh ubah turut dijalankan iaitu menggunakan analisis *T-test*. Sebelum analisis ini dijalankan, satu ujian kenormalan telah dilakukan bagi melihat kenormalan data. Hasil ujian ini mendapati data statistik skewness (-0.417) dan kurtosis (-0.056) bagi tahap penerimaan pelajar tahfiz terhadap program latihan bertabur secara normal. Menurut Hair et al. (2010) data diterima sebagai normal apabila nilai skewness dan kurtosis berada dalam lingkungan -2.00 hingga 2.00. Oleh itu, ujian parametrik boleh dijalankan kerana data yang diperolehi adalah bertabur secara normal. Maka, Ujian T akan dilakukan untuk mengenal pasti perbezaan bagi konstruk tahap

penerimaan pelajar tahfiz terhadap program latihan kemahiran berdasarkan kepada demografi responden iaitu jantina.

DAPATAN KAJIAN

Dapatan kajian ini memaparkan latar belakang responden kajian di mana persoalan yang pertama iaitu ‘berapakah kekerapan pelajar tahfiz yang menyertai kursus di kolej komuniti?’ ini boleh dijawab menerusi tinjauan ini. Selain itu, analisis deskriptif juga dijalankan bagi menjawab persoalan kajian yang kedua iaitu ‘apakah tahap penerimaan pelajar tahfiz terhadap program latihan kemahiran di kolej komuniti?’. Kemudian, satu analisis inferensi juga turut dijalankan bagi menjawab persoalan ketiga kajian iaitu ‘sejauh manakah perbezaan tahap penerimaan pelajar tahfiz terhadap program latihan kemahiran di kolej komuniti berdasarkan jantina?’. Responden yang terlibat dalam kajian ini adalah seramai 70 orang pelajar tahfiz yang telah mengikuti kursus Pendidikan Islam Sepanjang Hayat (PISH) di Kolej Komuniti Chenderoh, Kolej Komuniti Sungai Siput dan Kolej Komuniti Kuala Kangsar. Dapatan kajian ini menjadi asas kepada perbincangan, cadangan dan kesimpulan terhadap kajian.

Latar Belakang Responden Kajian

Profil sampel kajian merujuk kepada latar belakang demografi sampel iaitu jantina, tempat tinggal, dan kekerapan menyertai kursus Pendidikan Islam Sepanjang Hayat (PISH) yang dianjurkan oleh pihak kolej komuniti.

Hasil kajian menunjukkan jantina lelaki bagi responden adalah seramai 53 orang (75.7%), manakala jantina perempuan seramai 17 orang (24.3%). Ini menunjukkan penyertaan kursus Pendidikan Islam Sepanjang Hayat (PISH) ini melibatkan ramai pelajar tahfiz lelaki daripada pelajar tahfiz perempuan.

Profil bagi lokasi tempat tinggal pula menunjukkan sejumlah 49 orang (70.0%) tinggal di bandar, manakala seramai 21 orang (30.0%) tinggal di luar bandar. Data ini menjelaskan bahawa pelajar tahfiz yang mengikuti kursus kemahiran di bawah Pendidikan Islam Sepanjang Hayat (PISH) banyak melibatkan pelajar yang menetap di kawasan bandar daripada pelajar yang menetap di kawasan luar bandar.

Analisis profil seterusnya adalah berkaitan dengan kekerapan pelajar tahfiz ini menyertai atau mengikuti kursus latihan kemahiran yang dianjurkan oleh Kolej Komuniti di bawah kursus Pendidikan Islam Sepanjang Hayat (PISH). Dapatan data menunjukkan seramai 36 orang (51.4%) daripada pelajar tahfiz telah mengikuti kursus sebanyak 1-3 kali, 34 orang (48.6%) telah mengikuti kursus sebanyak 4-6 kali, manakala tiada pelajar tahfiz yang pernah mengikuti kursus melebihi 7 kali. Keadaan ini jelas menggambarkan kursus-kursus latihan kemahiran yang ditawarkan kepada pelajar tahfiz mendapat sambutan yang menggalakkan dan boleh untuk terus dilaksanakan dengan lebih kerap lagi pada masa akan datang.

Jadual 1. Latar Belakang Responden

Item	Frekuensi (<i>n</i>)	Peratus (%)
Jantina		
Lelaki	53	75.7
Perempuan	17	24.3
Tempat Tinggal		
Bandar	49	70.0
Luar Bandar	21	30.0
Kekerapan Menyertai Kursus		

1-3 kali	36	51.4
4-6 kali	34	48.6
7-9 kali	-	-
10 kali	-	-

N70

Analisis Deskriptif

Jadual 2 di bawah menunjukkan analisis taburan min dan peratusan yang dicapai bagi setiap pernyataan item soalan mengenai tahap penerimaan pelajar tahfiz terhadap program latihan kemahiran di kolej komuniti.

Jadual 2. Tahap Penerimaan Pelajar Tahfiz terhadap PLK di Kolej Komuniti

Bil	Item	Kekerapan & Peratusan (N=70)					Min (M)	Interpretasi
		STS (%)	TS (%)	KP (%)	S (%)	SS (%)		
B1	Saya sangat berpuas hati dengan hasil pembelajaran.	1 (1.4)	1 (1.4)	5 (7.1)	33 (47.1)	30 (42.9)	4.29	Tinggi
B2	Saya berpendapat kursus PISH memberikan impak yang positif terhadap kehidupan saya.	0 (0)	2 (2.9)	10 (14.3)	40 (57.1)	18 (25.7)	4.06	Tinggi
B3	Saya akan mempraktikkan ilmu yang diperolehi daripada kursus ini.	0 (0)	1 (1.4)	9 (12.9)	40 (57.1)	18 (28.6)	4.13	Tinggi
B4	Saya akan berkongsi ilmu yang diperolehi untuk dimanfaatkan kepada orang ramai.	0 (0)	0 (0)	10 (14.3)	28 (40.0)	32 (45.7)	4.31	Tinggi
B5	Saya akan menyertai lagi kursus-kursus PISH pada masa akan datang.	0 (0)	1 (1.4)	14 (20.0)	29 (41.4)	26 (37.1)	4.14	Tinggi
B6	Kursus ini dapat memenuhi tuntutan fardhu ain bagi setiap individu muslim.	0 (0)	2 (2.9)	9 (12.9)	36 (51.4)	23 (32.9)	4.14	Tinggi
B7	Kursus ini dapat memenuhi tuntutan fardhu kifayah bagi setiap individu muslim.	0 (0)	0 (0)	12 (17.1)	35 (50.0)	23 (32.9)	4.16	Tinggi
B8	Kursus ini dapat meningkatkan motivasi untuk berjaya dalam kehidupan di dunia dan akhirat.	0 (0)	1 (1.4)	11 (15.7)	35 (50.0)	23 (32.9)	4.14	Tinggi
B9	Kursus ini dapat meningkatkan pengetahuan dan kemahiran saya	0 (0)	0 (0)	3 (4.3)	36 (51.4)	31 (44.3)	4.40	Tinggi
B10	Kursus ini amat sesuai untuk pelbagai lapisan masyarakat.	0 (0)	1 (1.4)	6 (8.6)	35 (50.0)	28 (40.0)	4.29	Tinggi
KESELURUHAN						4.21	Tinggi	

Tahap penerimaan pelajar tahfiz terhadap program latihan kemahiran di kolej komuniti

Berdasarkan skor min dalam jadual 2, item B9 menunjukkan penilaian min yang paling tinggi di antara keseluruhan item soalan yang lain iaitu sebanyak (min=4.40). Berdasarkan item ini, sebanyak 51.4% responden 'setuju' dan 44.3% yang memilih 'sangat setuju', 4.3% memilih 'kurang pasti' manakala tiada responden yang memilih 'tidak setuju' dan 'sangat tidak setuju'. Hal ini menjelaskan bahawa ramai responden bersetuju bahawa kursus ini dapat meningkatkan pengetahuan dan kemahiran mereka.

Seterusnya item B2 menunjukkan skor penilaian nilai min yang paling rendah di antara item soalan yang lain iaitu nilai (min=4.06). Jumlah peratusan bagi item ini menunjukkan sebanyak 57.1% responden 'setuju', 25.7% responden 'sangat setuju', 14.3% responden 'kurang pasti', 2.9% responden 'tidak setuju' manakala tiada responden yang memilih 'sangat tidak setuju' terhadap pernyataan tersebut. Walaupun mendapat penilainan nilai min yang paling rendah berbanding item soalan yang lain, tahap interpretasi bagi item ini masih berada pada tahap yang tinggi. Oleh itu, keadaan ini menjelaskan bahawa ramai pelajar tahfiz berpendapat bahawa kursus PISH dapat memberikan impak yang positif terhadap kehidupan mereka.

Skor penilaian nilai min bagi item B1, B3, B4, B5, B6, B7, B8, dan B10 juga masing-masing menunjukkan tahap interpretasi min yang tinggi secara keseluruhannya. Justeru, keadaan ini menjelaskan bahawa majoriti daripada pelajar tahfiz telah memberikan maklum balas yang positif bagi pernyataan soalan berkaitan kursus PISH umumnya dan Program Latihan Kemahiran (PLK) khususnya.

Taburan kepada jawapan responden bagi kesemua item soalan berkaitan penerimaan pelajar tahfiz terhadap PLK kolej komuniti juga menunjukkan skala 4 (setuju) menyumbang peratusan paling tinggi iaitu sebanyak 49.55% dan diikuti oleh skala 5 (sangat setuju) sebanyak 36.3%. Hal ini menunjukkan majoriti daripada responden memilih skala setuju sebagai pilihan jawapan kepada soalan yang telah dikemukakan. Hal ini disokong oleh nilai peratusan yang tinggi bagi setiap item soalan yang telah dikemukakan berkaitan kursus program latihan kemahiran, PISH kepada pelajar tahfiz.

Secara keseluruhannya, tahap penerimaan pelajar tahfiz terhadap program latihan kemahiran di bawah kursus Pendidikan Islam Sepanjang Hayat (PISH) di kolej komuniti berada adalah tinggi merujuk kepada jumlah keseluruhan nilai min sebanyak (min=4.21) iaitu berada pada tahap interpretasi yang tinggi. Maklum balas yang positif ini menggambarkan penerimaan yang positif terhadap kursus kemahiran yang telah dilaksanakan oleh pihak kolej komuniti bersama pelajar tahfiz.

Analisis Inferensi (T-TEST)

Ho₁ Tidak terdapat perbezaan yang signifikan antara tahap penerimaan pelajar tahfiz terhadap program latihan kemahiran berdasarkan jantina.

Berdasarkan Jadual 3 di bawah, skor min lelaki terhadap pemboleh ubah tahap penerimaan ialah 4.25 manakala skor min bagi pelajar perempuan pula ialah 4.08. Pemboleh ubah ini tidak menunjukkan perbezaan yang signifikan iaitu berada pada tahap 0.407 ($t=1.421$, $df=68$, $p>0.05$). Oleh hal yang demikian, dapat disimpulkan bahawa tidak terdapat perbezaan yang signifikan terhadap tahap penerimaan pelajar tahfiz berdasarkan jantina dalam mengikuti program latihan kemahiran di kolej komuniti. Maka, Ho₁ adalah diterima.

Jadual 3. Perbezaan Tahap Penerimaan Pelajar Tahfiz terhadap Program Latihan Kemahiran di Kolej Komuniti berdasarkan Jantina

Pemboleh ubah	Jantina	N	Min	SP	df	<i>t</i>	<i>p</i>
Tahap Penerimaan	Lelaki	53	4.25	0.417	68	1.421	0.407
	Perempuan	17	4.08	0.472			

PERBINCANGAN DAPATAN KAJIAN

Dapatan kajian berkaitan penerimaan peserta terhadap kursus Pendidikan Islam Sepanjang Hayat menerusi Program Latihan Kemahiran (PLK) yang melibatkan pelajar tahfiz menunjukkan bahawa majoriti daripada peserta berpuas hati dengan hasil pembelajaran yang diperolehi. Selain itu, program latihan kemahiran yang dijalankan di bawah kursus Pendidikan Islam Sepanjang Hayat ini juga dapat memberikan implikasi yang positif dimana mereka mampu untuk mempraktikkan ilmu yang telah dipelajari bahkan dapat melakukan perkongsian ilmu bersama orang lain. Di samping itu juga, Program Latihan Kemahiran bersama pelajar tahfiz ini dapat memenuhi tuntutan fardhu ain dan kifayah serta meningkatkan ilmu pengetahuan, kemahiran dan motivasi kepada peserta. Hal ini dibuktikan melalui dapatan kajian bagi setiap konstruk yang dilihat memperoleh nilai skor min yang tinggi bagi setiap item dalam konstruk tahap penerimaan peserta. Dapatan ini bertepatan dengan kajian yang dijalankan oleh Surizan et al. (2015) mengenai penerimaan peserta tahfiz terhadap kursus pendidikan Islam sepanjang hayat yang juga menunjukkan skor min yang tinggi dalam kajian tersebut. Ini bermakna kursus pendidikan Islam sepanjang hayat yang dijalankan di kolej komuniti memberikan impak yang positif kepada peserta yang menyertai kursus tersebut. Perkara ini disokong oleh dapatan kajian yang dilakukan oleh Thilagavathi dan Siti Nur Haslinda (2015) serta Azlah Md Ali (2009) yang menunjukkan bahawa kesemua peserta bersetuju bahawa latihan yang diikuti dapat meningkatkan ilmu pengetahuan, kemahiran dan motivasi serta memberikan impak yang positif kepada diri peserta. Namun demikian, dapatan yang memberi gambaran positif demikian tidak menafikan bahawa masih terdapat juga responden yang menyatakan pandangan tidak bersetuju untuk menghadiri kursus pendidikan Islam sepanjang hayat pada masa akan datang dan tidak berpuas hati dengan hasil pembelajaran dan impak yang diperolehi daripada kursus ini. Walaupun jumlahnya sekitar satu hingga lima orang responden, ianya perlu diberikan perhatian semula agar kesemua peserta memperoleh manfaat dan berminat untuk menyertai kursus sebegini pada masa akan datang. Punca mahupun kesan daripada pelaksanaan bagi setiap kursus yang dijalankan perlu untuk dititikberatkan supaya pelaksanaan kursus dapat ditambahbaik dari semasa ke semasa dan mencapai objektif yang telah digariskan. Dapatan ini juga bertepatan dengan kajian oleh Fadillah et al. (2018) yang menunjukkan tahap keberkesanan dari sudut penerimaan peserta terhadap pembelajaran dan kefahaman adalah pada tahap yang sederhana. Oleh hal yang demikian, beberapa cadangan penambahbaikan perlu dikemukakan kepada penyelaras bagi setiap kursus pendidikan Islam sepanjang hayat di kolej komuniti.

Selain itu, dapatan kajian juga menunjukkan bahawa tidak terdapat perbezaan yang signifikan bagi tahap penerimaan program latihan kemahiran di kolej komuniti berdasarkan jantina sama ada lelaki mahupun perempuan. Tahap penerimaan peserta tahfiz adalah sama walaupun jumlah penyertaan terhadap program latihan kemahiran ini lebih didominasi oleh peserta lelaki. Dapatan ini menjelaskan bahawa program latihan kemahiran di bawah kursus pendidikan Islam sepanjang hayat sesuai untuk disertai oleh lelaki mahupun perempuan. Kenyataan ini disokong oleh Noraina et al., (t.t) yang mengatakan bahawa kursus-kursus pendek yang dianjurkan boleh disertai oleh semua golongan dan lapisan masyarakat tidak

mengira latar belakang mahupun jantina. Hal ini adalah kerana matlamat utama penganjuran kursus pendek bagi pendidikan Islam sepanjang hayat adalah untuk memberikan ilmu kemahiran dan keusahawan kepada pelajar tahfiz, pelajar sekolah pondok, pelajar maahad dan institusi agama yang lain. Jadi, kebanyakannya kursus yang ditawarkan adalah bersesuaian untuk lelaki dan perempuan, bahkan menurut Mohd Rashidi et al., (2021) dalam kajiannya menjelaskan bahawa tahap penerimaan bagi perbezaan kawasan tempat tinggal iaitu bandar dan luar bandar juga sama walaupun suasana kehidupan peserta adalah berbeza.

CADANGAN DAN IMPLIKASI KAJIAN

Pelaksanaan kajian tahap penerimaan pelajar tahfiz terhadap program latihan kemahiran di kolej komuniti sudah tentu membawa implikasi kepada dunia pendidikan khususnya dalam mencapai objektif Pembelajaran Sepanjang Hayat (PSH). Tujuan penilaian terhadap tahap penerimaan oleh pelajar tahfiz dilakukan adalah untuk mengetahui sejauh mana keberkesanan kursus-kursus kemahiran yang telah dijalankan oleh pihak kolej komuniti kepada peserta. Oleh yang demikian, kajian penilaian yang dilakukan ini boleh untuk dijadikan sebagai rujukan bagi pihak di Jabatan Politeknik dan Kolej Komuniti (JPPKK) umumnya dan khususnya pihak di seluruh kolej komuniti Malaysia terutamanya bagi Unit Pembelajaran Sepanjang Hayat (PSH).

Pelaksanaan kajian ini turut membawa implikasi yang positif buat para tenaga pengajar khususnya yang memberi tunjuk ajar bagi setiap kursus yang dijalankan. Para tenaga pengajar perlu untuk didedahkan kepada tahap penerimaan peserta yang telah mengikuti kursus-kursus yang dianjurkan bagi mengetahui maklum balas supaya kekurangan serta kelebihan yang ada dapat membantu kepada peningkatan kualiti pengajaran pada masa akan datang. Kajian ini secara umumnya berperanan memberikan sumbangan kepada pihak yang terlibat dalam pelaksanaan kursus Pendidikan Islam Sepanjang Hayat dengan menekankan aspek amalan pengajaran pensyarah. Pihak yang terlibat dengan kursus PISH ini dapat mengatur langkah dan strategi untuk meningkatkan mutu dan kualiti kursus PISH berdasarkan kepada maklumat dan data yang lengkap. Kekurangan dan kelemahan yang dapat dikenal pasti perlu diatasi dan ditambahbaik dengan kadar yang segera serta kelebihan yang ada dalam pelaksanaan ini perlu dikekalkan dan dimurnikan. Penilaian ini bukan sahaja memberi implikasi kepada tenaga pengajar, bahkan kajian sebegini juga dilihat mampu untuk menyampaikan suara peserta yang telah mengikuti kursus-kursus yang telah dilaksanakan bagi persediaan untuk melakukan penambahbaikan kursus pada masa akan datang.

Seterusnya, kajian ini juga merupakan panduan bagi kajian-kajian seterusnya pada masa akan datang terutamanya yang berkaitan dengan keberkesanan dan kepuasan peserta dalam menyertai kursus di bawah Unit Pembelajaran Sepanjang Hayat. Skop kajian yang lebih luas perlu untuk dilakukan bagi membantu menambahbaik pelaksanaan kursus yang dijalankan. Antara skop kajian yang masih perlu untuk diberikan tumpuan adalah berkaitan teknik dan gaya pembelajaran yang digunapakai dalam pelaksanaan kursus, keberkesanan amalan pengajaran bagi pelaksanaan kursus yang dianjurkan, sikap dan minat peserta terhadap kursus-kursus yang ditawarkan, pengurusan kursus dan lain-lain lagi. Selain itu, kajian ini juga terhad kepada sampel pelajar tahfiz di kolej komuniti dalam negeri Perak sahaja. Justeru itu, dicadangkan kajian-kajian mendatang dapat melibatkan sampel dari semua kolej komuniti di Malaysia agar kursus-kursus PISH yang dianjurkan dapat diterima dan ditambah baik dari semasa ke semasa.

KESIMPULAN

Trend yang berlaku pada hari ini menunjukkan bahawa umat Islam mulai sedar akan kelebihan dan keberkesanan martabat bagi individu yang menghafal al-Quran. Gambaran jelas ini boleh dilihat apabila kebanyakan ibu bapa mula menghantar dan menempatkan anak-anak mereka ke sekolah aliran tahfiz (Ulwan, 2015). Mohd Nawi et al. (2020) turut mengakui bahawa saban tahun perkembangan sekolah-sekolah aliran tahfiz boleh dikatakan bagaikan cendawan tumbuh selepas hujan dengan kehadiran ramai pelajar yang ingin mendaftar masuk untuk menyambung pengajian. Selain itu, program-program yang melibatkan latihan kemahiran yang menyasarkan pelajar tahfiz juga turut dibangunkan menyebabkan sistem akademik bagi pelajar tahfiz bukan sahaja berfokuskan aktiviti keagamaan sahaja bahkan memberi banyak peluang kepada pelajar ini untuk berdaya saing dipasaran global apabila menamatkan pengajian kelak. Ekoran daripada dapatan kajian ini juga menunjukkan tahap penerimaan peserta tahfiz terhadap program latihan kemahiran yang dijalankan adalah pada tahap yang amat baik secara keseluruhannya. Keadaan ini menunjukkan bahawa majoriti daripada peserta berpuas hati dengan hasil pembelajaran daripada penganjuran kursus ini. Selain itu, menerusi kajian ini juga dapat disimpulkan bahawa perbezaan jantina bukanlah satu masalah kepada penyertaan terhadap kursus-kursus latihan kemahiran sebegini kerana keberkesanan serta penawaran kursus latihan kemahiran adalah dianggap sesuai untuk diikuti oleh semua lapisan umur dan masyarakat, apatah lagi perbezaan jantina. Justeru itu, diharapkan dapatan kajian ini dapat menjelaskan sedikit sebanyak berkaitan penerimaan penawaran kursus yang disediakan khas buat pelajar tahfiz dan institusi agama lain di bawah program latihan kemahiran di kolej komuniti di Malaysia.

RUJUKAN

- Abdul Ghafar Haji Don, Ab. Halim Tamuri, Supyan Hussin & Mohd Aderi Che Noh. (2015). Penilaian Keberkesanan Kursus Pusat Latihan Pengurusan Pendidikan Islam Institut Latihan dan Dakwah Selangor (ILDAS). Jurnal Kepimpinan Pendidikan 2015. Universiti Malaya.
- Azlah Md Ali, Rozeyta Omar, Noor Ella Mohamad Zip, Nor Suziani Ismail & Thahiroh Zulkifli (2009). *Keberkesanan Latihan Kakitangan Kumpulan Sokongan Di Pejabat Setiausaha Kerajaan Negeri Kedah Darul Aman. In: Amalan Latihan dan Pembangunan Manusia di Malaysia*. Penerbit UTM Press, Skudai Johor, pp. 57-82.
- Fadillah, I., Fatin, I., Adibah, A. K., Lutfan, J., & Fauziah, A. (2018). *Keberkesanan Seminar Pengukuhan Integriti*. Universiti Tun Hussein Onn Malaysia.
- Hair, J. F., Anderson, R. E., Tatham, R. L., & Black, W. C. (2010). *Multivariate data analysis seventh edition*. New York: Prentice Hall International Inc.
- Hamidah, A. R., & Rozeyta, O. (2009). *Persepsi Staf Sokongan Pentadbiran dan Teknikal Terhadap Program Latihan di UTM*. Penerbit UTM Press: Skudai, Johor.
- Hazwani, H., & Nor Aishah, B. (2018). Program Pembelajaran Sepanjang Hayat (PSH) terhadap Pengetahuan dan Tahap Kemahiran Pelajar Kolej Komuniti. *Jurnal Pendidikan Malaysia*, 1(1), 89-106. DOI: <http://dx.doi.org/10.17576/JPEN-2018-43.03-10>
- Jabatan Pendidikan Kolej Komuniti. (2017a). *Sejarah Penubuhan*. <http://www.jpkk.edu.my/v2/info-korporat/sejarah-kolejkomuniti.html>.
- Jabatan Pendidikan Kolej Komuniti. (2017b). *Maklumat Kursus dan Pengajian*. http://www.jpkk.edu.my/v2/index.php?option=com_content&view=article&id=183.
- Jabatan Pendidikan Kolej Komuniti. (2017c). *Senarai Kolej Komuniti*. <http://www.jpkk.edu.my/v2/info-korporat/senaraikolej.html>

- Kementerian Pendidikan Tinggi. (2017). Pelan Induk Pendidikan Islam Sepanjang Hayat 2017-2025. Edisi 2017.
- [Khairunneezam, M. N. \(2004\). *Konsep Program Latihan Sumber Manusia*, dalam Shamsul Bahri Andi Galigo, Khairunneezam Mohd Noor, Wan Mohd Fazrul Azdi Wan Razali, Rozita Abdullah \(2004\), *Membangun Masyarakat Moden yang Berilmu dan Berakhlak*, Penerbit USIM: Kuala Lumpur.](#)
- Mohd Nawawi, M. Z., Omar, M. R., & Mohd Nor, M. A. (2020). *Pendidikan Tahfiz Sepadu Dunia Akhirat*. Santai Ilmu Publication.
- Mohd. Majid, K. (2005). *Kaedah Penyelidikan Pendidikan*. Kuala Lumpur: Dewan Bahasa dan Pustaka.
- Mohd Rashidi O., Azmil H., Muhammad Zulazizi, M. N., (2021). Tahap Penerimaan Peserta terhadap Kursus Pendidikan Islam Sepanjang Hayat (PISH). *Attarbawiy: Malaysian Online Journal of Education Vol. 5, No.1 (2021), 54-63*
- Nurul Huda. (t.t). Kepuasan Peserta Kursus Pendek Terhadap Kemudahan dan Perkhidmatan di Kolej Komuniti Hulu Langat, Selangor.
- Noraina, Sarah, Firdaus, Elmiza & Roswani. (t.t). *Garis Panduan: Pelaksanaan Program PSH di Kolej Komuniti [Edisi 2017]*. <https://www.mypolycc.edu.my/index.php/muat-turun/garis-panduan-c/bahagian-kurikulum/download/12-bk/65-garis-panduan-pelaksanaan-program-psh-di-kolej-komuniti>
- Nornazlina, Wan Marina, & Roswani. (t.t). *Program Pendidikan Islam Sepanjang Hayat (Pish): Memperkasakan Ummah Dan Ekonomi Negara*. <https://dokumen.tips/reader/f/program-pendidikan-islam-sepanjang-hayat-pish->
- Nor Azida Mansor, Nor Idayu Shafiza Mohd Najib & Zariasya Jumaat. (2015). Keberkesanan Pendidikan Islam Sepanjang Hayat (PISH) di Kolej Komuniti Ledang. *Jurnal Pendidikan Sepanjang Hayat*. Jabatan Pendidikan Kolej Komuniti 2015.
- Solahuddin I. (2016). Institusi Tahfiz di Malaysia: Prospek dan Cabaran. Conference: *Simposium Tahfiz al-Quran Peringkat Antarabangsa At: Institut Latihan Islam Malaysia (ILIM) Bangi Selangor Volume: 1*
- Suriyana, S., Suhaila, H., & Wan Fadhillah (2017). Mengenalpasti Tahap Kepuasan Peserta Terhadap Pelaksanaan Kursus Pendek di Kolej Komuniti Selandar, Melaka. *Journal of life long learning, Vol. 1, No.1, 2017 eISSN 2600- 7738*. Politeknik dan Kolej Komuniti.
- Surizan, R., Zatil, A. S., Ali, O., & Mohamad Khairi, O. (2015). Hubungan Pengajaran Pensyarah dan Minat Pelajar Tahfiz dengan Program Pendidikan Islam Sepanjang Hayat (PISH) di Kolej Komuniti. *Jurnal Pendidikan Sepanjang Hayat*. Jabatan Pendidikan Kolej Komuniti 2015.
- Thilagavathi, M., & Siti Nur Haslinda, D. (2015). Kajian Terhadap Kepuasan Peserta Kursus Pendek Kluster Katering dan Sajian di Kolej Komuniti Lahad Datu. *Jurnal Pembelajaran Sepanjang Hayat 2015*. Jabatan Pendidikan Kolej Komuniti.
- Ulwan, A. N. (2015). *Tarbiyatul Aulad (Edisi Terjemahan)*. Kuala Lumpur: PTS Publications.
- Yufiza, M. Y., Rafidah, M. B., Saleha., A. A., & Zamaruzaman. (2016). *Perlaksanaan Pendidikan Islam Sepanjang Hayat di Kolej Komuniti Kementerian Pendidikan Malaysia*. Kolej Komuniti Batu Gajah. http://umcced.edu.my/psh2016/web_paper/2.4.1.pdf
- Zulkiple, A. G., Noor Azizi, I., & Adnan, M. Y. (2015). *Pendidikan Islam Sepanjang Hayat di Univerisiti Sains Islam Malaysia: Cabaran Dan Hala Tuju*. Prosiding Seminar Pendidikan Islam Sepanjang Hayat Peringkat Nasional 2015, Jabatan Pendidikan Kolej Komuniti 2015.

Pelaksanaan Taksonomi Fikir-Zikir (FiZi) Di Sekolah Terpilih Yayasan Islam Kelantan (YIK)

Noor Hisham Md Nawi
Fakulti Pengajian Bahasa dan Pembangunan Insan
Universiti Malaysia Kelantan
hisham@umk.edu.my

ABSTRAK

Ramai sarjana pendidikan Islam mengkritik Taksonomi Bloom atas beberapa kelemahannya dan berusaha untuk membina taksonomi alternatif. Taksonomi Fikir-Zikir (ZiFi) adalah salah satu taksonomi alternatif yang bertujuan untuk membantu guru melaksanakan PdP bersepadu. Kesepaduan dalam penulisan ini adalah merujuk kepada kesepaduan fardu ain dan fardu kifayah. Taksonomi FiZi adalah satu usaha penggabungan potensi fikir pelajar berasaskan domain kognitif dengan potensi zikir berasaskan domain kerohanian. Ia mengandungi lapan tahap yang boleh memandu guru tentang aras kesepaduan yang diinginkan dan dirancang dalam proses PdP. Tujuan kajian ini adalah untuk menguji kebolehlaksanaan Taksonomi FiZi di beberapa sekolah terpilih di bawah kelolaan Yayasan Islam Kelantan (YIK). Kajian menggunakan kaedah Diskusi Kumpulan Berfokus (FGD) untuk mendapatkan pandangan peserta tentang kebolehlaksanaan Taksonomi FiZi dalam menghasilkan PdP bersepadu. Analisis FGD telah menghasilkan 5 tema besar iaitu kefahaman makna pendidikan bersepadu dan PdP bersepadu dalam kalangan peserta, realiti pelaksanaan PdP bersepadu, latihan dan pendedahan PdP bersepadu, penilaian aplikasi Taksonomi FiZi dan cadangan penambahbaikan pelaksanaan pendidikan bersepadu dengan menggunakan Taksonomi FiZi. Setiap tema tersebut mengandungi beberapa sub tema yang tersendiri. Taksonomi FiZi ini adalah salah satu dari mata rantai usaha berterusan untuk mencapai matlamat yang lebih besar iaitu melaksanakan gagasan pendidikan bersepadu bagi melahirkan insan soleh-muslih yang berperanan besar dalam pembangunan ummah.

Kata kunci: *Taksonomi, pendidikan bersepadu, fikir, zikir, pandangan alam Islam*

PENDAHULUAN

Sebahagian besar sistem pendidikan di seluruh dunia termasuk negara Islam menggunakan Taksonomi Bloom. Taksonomi Bloom banyak membantu pendidik khususnya dalam aspek pengurusan kurikulum dan mendapatkan penilaian dengan lebih tepat. Ia juga membantu penggubal kurikulum menentukan objektif-objektif supaya lebih mudah merancang pembelajaran dan penilaian (Mike, 2013). Walau bagaimanapun, Taksonomi juga mengandungi beberapa kelemahan yang mengundang pelbagai kritikan sama ada dari sarjana Barat (Furst, 1981; Brenda Sugrue, 2002; Paul & Elder, 2006; Gueguen, 2016; Jason Barney 2020) dan juga Timur (Amer, 2006; Long et. al 2015; Mohd Syaubari dan Ahmad Yunus 2016; Nursyahirah et. al 2018; Suliswiyadi (2020). Antara kritikan utama terhadap Taksonomi Bloom ialah penumpuan yang ekstrim terhadap domain kognitif dan pengabaianya terhadap domain kerohanian. Di samping itu, Taksonomi Bloom juga bersifat individualistik dengan tidak mengambil kira pengaruh pelbagai kuasa sosial dalam proses pembelajaran dan mengandaikan bahawa proses pembelajaran bersifat berurutan serta sangat linear. Justeru, pelbagai pihak telah memberi cadangan agar Taksonomi Bloom perlu disemak semula dan digantikan dengan taksonomi yang lebih sesuai untuk abad ke-21.

PERMASALAHAN KAJIAN

Secara sepintas lalu, Taksonomi Bloom dilihat tiada masalah dengan pandangan alam Islam sehingga ia dimanfaatkan dalam tempoh masa yang lama tanpa sebarang kritikan dan bantahan. Walau bagaimanapun, akhir-akhir ini semakin ramai para pendidik muslim mula menyedari kelompongan Taksonomi Bloom dalam menyantuni aspek kerohanian khususnya dalam kategori ilmu fardu ain yang sukar untuk dibuktikan atau diukur secara objektif dan saintifik. Komponen kognitif berbeza dengan komponen kerohanian meskipun keduanya mempunyai hubungan yang sangat erat dan tidak boleh dipisahkan.

Permasalahan utama yang berlaku dalam sistem pendidikan umat Islam masa kini ialah tiadanya kesepaduan dan kesinambungan yang harmoni antara hierarki ilmu (fardu ain dan fardu kifayah) dan kesemua komponen atau domain dalam diri manusia (psikomotor, kognitif, afektif dan kerohanian). Sistem pendidikan yang ada tidak bermatlamatkan untuk menyepadukan ilmu fardu ain dengan ilmu fardu kifayah dengan menjadikan ilmu fardu ain sebagai teras dan asas. Kedua-duanya dipelajari secara berasingan dalam kotak masing-masing. Demikian juga dalam diri pelajar, semua domain seharusnya saling berinteraksi antara satu sama lain dengan menjadikan komponen rohani (al-qalb) sebagai pemimpin kepada komponen yang lain. Al-qalb atau hati manusia yang menyusun nilai-nilai utama yang kemudiannya melahirkan pelbagai pembuatan keputusan dalam kehidupan. Walau bagaimanapun, komponen yang paling diberi keutamaan dalam sistem pendidikan semasa dan Taksonomi Bloom adalah kognitif. Atas premis tersebut ramai pihak telah berusaha membina taksonomi baharu seperti yang dikemukakan oleh Ah. Zakki (2014), Suliswiyadi (2020), dan Noor Hisham (2021) sebagai alternatif kepada taksonomi yang sedia ada.

TUJUAN

Tujuan kajian ini adalah untuk menguji kebolehlaksanaan Taksonomi FiZi di beberapa sekolah terpilih di bawah kelolaan Yayasan Islam Kelantan (YIK). Taksonomi FiZi telah dibangunkan oleh penulis untuk membantu para guru melaksanakan proses PdP yang bersepadu. Taksonomi ini bukan hanya boleh membantu guru menyampaikan kandungan pengajaran dengan baik pada domain kognitif bahkan berupaya menanam nilai atau membina prinsip-prinsip penting dalam kehidupan dalam domain afektif dan kerohanian. Dengan lain perkataan, taksonomi ini diharap dapat membantu guru melaksanakan satu proses PdP yang mampu menggerakkan pemikiran pelajar secara aktif dan pada masa yang sama merangsang hati mereka agar mengingati kehebatan dan kebesaran Tuhan. Keupayaan untuk mengintegrasikan proses fikir dan zikir ini akan menjayakan konsep PdP bersepadu dan seterusnya pendidikan bersepadu.

Taksonomi FiZi dihasilkan melalui pengaplikasian konsep al-Attas bahawa perkembangan model pendidikan seharusnya bermula dari pengajian tinggi dan kemudiannya mengalir ke bawah sebagaimana tumpuan dakwah Rasulullah S.A.W adalah kepada orang dewasa dan kemudiannya merata kepada kelompok umur yang lain. Berdasarkan premis tersebut, penulis telah membangunkan satu taksonomi hasil daripada analisis dan sintesis model kesepaduan dari dua IPT terkenal iaitu Universiti Islam Antarabangsa Malaysia (UIAM) dan Universiti Sains Islam Malaysia (USIM). Taksonomi PdP FiZi mempunyai lapan tahap dengan ciri-cirinya yang tersendiri

METODOLOGI

Kajian ini menggunakan kaedah penyelidikan bersepadu yang mengiktiraf semua sumber ilmu dalam tradisi Islam secara berhierarki dan menyepadukan sumber naqli dan aqli dengan menjadikan pedoman wahyu sebagai teras dan pemutus. Secara lebih tepat, kaedah penyelidikan bersepadu adalah suatu usaha mencari jawapan dan kebenaran kepada sesuatu persoalan dengan menggunakan kaedah yang sistematik, boleh dipercayai dan sah serta berdasarkan bukti-bukti yang sahih sama ada bersifat empirikal (pengalaman), rasional (hujah aqliyah) mahupun hujah naqliyah yang berada dalam kerangka tasawwur Islam atau pandangan alam Islam (Noor Hisham 2018). Untuk menghasilkan taksonomi baharu tersebut, kajian ini telah melalui beberapa fasa penting dengan menggunakan beberapa kaedah bermula dengan kajian perpustakaan, kaedah penyelidikan turath Islami dan analisis dokumen.

Walau bagaimanapun dalam penulisan ini, tumpuan hanya akan diberikan kepada kaedah keempat iaitu kaedah diskusi kumpulan berfokus atau *focus group discussion* (FGD). Kaedah ini berbentuk penyelidikan kualitatif bersama sekumpulan individu (5-8 orang) untuk membincangkan mengenai topik yang ditetapkan. Peserta kumpulan fokus dipilih dari sekelompok guru berdasarkan kesesuaian dan hubungan mereka dengan topik yang dikaji dengan ciri-ciri yang ditetapkan oleh penyelidik. Taksonomi FiZi telah dilaksanakan di 4 buah sekolah YIK iaitu Maahad Muhammadi Perempuan (MMP), Maahad Sains Tok Guru (MSTG), Maktab Pengajian Islam (MPI) dan Maahad Tarbiah Mardziah Panchor (MTMP) yang melibatkan 20 orang guru. Guru-guru diberi taklimat dan latihan terlebih dahulu sebelum mereka diminta untuk mengaplikasikannya dalam kelas masing-masing. Setelah selesai semua sesi PdP, semua peserta dikumpul di sekolah masing-masing dan diminta untuk membincangkan aspek-aspek tertentu dalam persekitaran yang santai, selesa, dan seronok. Mereka diminta untuk berkongsi idea dan persepsi mereka terhadap Taksonomi FiZi, fungsi dan kekuatan serta kelemahannya.

KAJIAN LITERATUR

Terdapat dua tema besar dalam penulisan ini iaitu taksonomi dan konsep pendidikan bersepadu. Kajian literatur ini akan menjelaskan kedua-dua tema besar tersebut sebagai asas kepada perbincangan berdasarkan objektif yang telah ditetapkan.

Taksonomi Pendidikan dan Taksonomi Berasaskan Fikir dan Zikir

Taksonomi berasal dari dua kata dalam bahasa Yunani, iaitu 'tassein' yang bermakna mengklasifikasi dan 'nomos' yang berarti aturan. Secara mudah taksonomi bermaksud hierarki klasifikasi berasaskan prinsip atau aturan tertentu. Semua hal yang bergerak, sesuatu yang diam, tempat, kejadian termasuk kemampuan berfikir dapat diklasifikasikan menurut beberapa aturan atau skema taksonomi. Terma taksonomi banyak digunakan dalam bidang biologi yang merujuk kepada klasifikasi makhluk hidup yang teratur dan berhierarki (Enghoff 2009). Dalam konteks Pendidikan, taksonomi banyak digunakan untuk mengklasifikasi objektif pendidikan agar para pendidik dapat merancang dan menilai objektif dalam sesuatu program pengajaran secara lebih berkesan.

Taksonomi dalam pendidikan sering dikaitkan dengan tujuan dan objektif pendidikan, proses pengajaran dan pembelajaran serta aspek penilaian. Taksonomi pendidikan sangat penting untuk mencapai tujuan dan hasil pembelajaran yang terarah. Taksonomi tujuan pendidikan adalah sebuah kerangka acuan untuk mengelompokkan kompetensi yang diharapkan tercapai oleh pelajar sebagai kesan dari hasil sebuah pembelajaran. Taksonomi

membantu pendidik untuk mengetahui secara jelas dan pasti tentang tujuan dan bentuk pengajaran yang ingin dicapai sama ada bersifat kognitif, afektif, kerohanian atau psikomotor. Ragam perbezaan setiap tujuan yang ingin dicapai dalam kegiatan pembelajaran akan mempengaruhi model, metode dan pendekatan yang akan diterapkan. Oleh karena itu, taksonomi secara keseluruhan akan memberikan pelbagai warna dan irama dalam kegiatan di kelas.

Terdapat pelbagai taksonomi dalam Pendidikan seperti Taksonomi Bloom, Taksonomi Marzano, Taksonomi Solo, Taksonomi Dave, Taksonomi Anderson dan lain-lain. Walau bagaimanapun, taksonomi yang paling berpengaruh dan paling banyak digunakan adalah Taksonomi Bloom. Taksonomi Bloom dibangunkan oleh Benjamin Samuel Bloom, seorang pakar dalam bidang psikologi pendidikan yang melakukan penyelidikan mengenai kemampuan berfikir dalam proses pembelajaran. Bloom dilahirkan di Lansford, Pennsylvania dan berhasil meraih doktor dalam bidang pendidikan dari Universiti Chicago pada tahun 1942. Beliau dikenali sebagai konsultan dan aktivis antarabangsa dalam bidang pendidikan dan berhasil membuat perubahan besar dalam sistem pendidikan di India. Antara karyanya yang penting ialah *Taxonomy of Educational Objectives: The Classification of Educational Goals* yang diterbitkan pada tahun 1956. Kekuatan terbesar taksonomi Bloom adalah kelebihanannya dalam mengangkat isu yang berkaitan dengan proses berfikir dan menempatkannya dalam sebuah struktur yang bermanfaat bagi para pendidik. Di samping sumbangannya yang besar, Taksonomi Bloom juga mempunyai beberapa kelemahan yang menjadi sasaran kritikan banyak pihak. Taksonomi Bloom juga dikritik oleh ramai pakar Pendidikan Islam dari aspek ketidakcukupannya terhadap domain kerohanian.

Ulama dan cendekiawan Islam mengaitkan aspek pemikiran bukan sekadar fenomena dan fungsi akal yang bersifat kognitif bahkan juga melibatkan fungsi hati dan kerohanian (Abdul Samad al-Falimbani, 2010). Ini bermakna bergantung kepada fungsi akal semata-mata tidak memadai untuk melaksanakan konsep pendidikan Islam sebagai satu sistem. Untuk melihat konsep berfikir dalam kerangka sistem pendidikan Islam, konsep kesepaduan berfikir diaplikasikan. Untuk membezakan antara dua komponen sebelumnya (domain kognitif dan domain kerohanian), dua istilah digunakan iaitu fikir (untuk kegiatan akal) dan zikir (untuk kegiatan hati). Menurut Mohd Zaidi (2014), kedua-duanya diperlukan untuk melengkapkan proses berfikir secara bersepadu dan menjadikan proses pengajaran dan pembelajaran menjadi lebih baik dan bermakna. Tempat fikir adalah pada akal dan hati manakala tempat zikir adalah pada hati. Taksonomi alternatif yang dibangunkan tersebut dinamakan sebagai Taksonomi FiZi dan mempunyai lapan tahap dengan ciri-cirinya yang tersendiri. Di peringkat sekolah menengah, hanya 6 tahap sahaja yang disyorkan. Taksonomi ini bermatlamatkan untuk membantu pendidik merancang PdP bersepadu mengikut konteks matapelajaran atau disiplin ilmu, kesediaan bahan dan kekuatan guru. Sila lihat rajah di bawah untuk mendapatkan gambaran Taksonomi FiZi.

MALAYSIA

KELANTAN

Rajah 1. Gambaran Taksonomi Fikir-Zikir (FiZi)



Untuk mendapat kefahaman yang lebih jelas, sila lihat huraian bagi setiap tahap berdasarkan Jadual 1 di bawah.

Jadual 1. Huraian Taksonomi Fikir-Zikir

TAHAP	HURAIAN
1 Terputus	Tiada hubungan atau hampir tiada hubungan antara kandungan ilmu dengan Allah dan nilai serta prinsip Islam.
2 Berhubung Secara Kabur	Tiada hubungan yang jelas antara kandungan ilmu dengan Allah dan nilai serta prinsip Islam.
3 Berhubung Secara Umum	Dapat menghubungkan kandungan ilmu yang dipelajari dengan Allah dan nilai serta prinsip Islam secara dangkal atau aras permukaan tanpa kefahaman yang mantap
4 Bersepadu Awalan	Dapat menghubungkan kandungan ilmu yang dipelajari dengan Allah dan nilai serta prinsip Islam secara jelas meskipun kurang mendalam.
5 Bersepadu Secara Jelas	Dapat menghubungkan kandungan ilmu yang dipelajari dengan Allah dan nilai serta prinsip Islam secara jelas dan mendalam.
6 Bersepadu Secara Mantap	Dapat menghubungkan kandungan ilmu yang dipelajari dengan Allah dan nilai serta prinsip Islam secara jelas, mendalam dan mengaplikasikannya dalam kehidupan.
7 Islamisasi Awalan	Dapat menghubungkan kandungan ilmu yang dipelajari dengan Allah dan nilai serta prinsip Islam secara jelas, mendalam, kritikal (pemurnian), integral dan bersepadu serta mengamalkannya dalam kehidupan.
8 Islamisasi Mantap	Dapat menghubungkan kandungan ilmu yang dipelajari dengan Allah dan nilai serta prinsip Islam secara jelas, mendalam sehingga menghasikan suatu kefahaman baharu yang segar dan relevan atau

inovasi Islami yang bermanfaat serta mampu mengamalkannya dalam kehidupan.

Taksonomi FiZi ini digunakan untuk membantu guru melaksanakan PdP bersepadu yang akan menggerakkan aktiviti fikir dan zikir secara serentak dan harmoni dengan menggabungkan ilmu fardhu ain dan juga fardhu kifayah. Ini bermakna semasa mempelajari ilmu sains moden yang berstatus fardhu kifayah (fikir), pelajar juga dididik untuk menghubungkannya dengan prinsip dan nilai-nilai yang terdapat dalam ilmu fardhu ain (zikir) secara harmoni dan sepadu. Demikian juga sebaliknya iaitu apabila pelajar mempelajari ilmu fardhu ain, mereka juga diasuh agar mengaitkannya dengan ilmu sains moden yang berstatus ilmu fardhu kifayah. Walau bagaimanapun tahap kesepaduan tersebut adalah berbeza-beza bermula dari yang paling rendah sehingga ke tahap yang tertinggi. Taksonomi ini sangat bermanfaat untuk membantu guru atau pensyarah merancang aras atau tahap kesepaduan yang diinginkan mengikut konteks matapelajaran atau disiplin ilmu, kesediaan bahan dan kekuatan guru. Taksonomi FiZi hanya menyediakan panduan kepada guru mengenai aras kesepaduan. Manakala strategi dan proses PdP diserahkan kepada kebijaksanaan dan pengalaman guru atau pensyarah.

Pendidikan Bersepadu

Konsep pendidikan bersepadu hampir dipersetujui oleh semua pemikir dan pakar pendidikan Islam sebagai satu strategi penting untuk memperbetulkan semula sistem pendidikan umat Islam. Pendidikan bersepadu menuntut semua pihak agar tidak lagi mengasingkan antara pendidikan asas agama yang bersifat fardhu ain dengan pendidikan ilmu aqli yang bersifat fardhu kifayah. Agenda ini memerlukan perancangan yang rapi dari aspek kejelasan falsafah, halatuju dan matlamat, rekabentuk kurikulum, penyampaian pengajaran dan pembelajaran dan penilaian pendidikan. Produk akhirnya ialah manusia yang beriman, bertaqwa, berilmu, kompeten, seimbang dan sepadu atau ringkasnya manusia yang soleh mengikut acuan Allah.

Terdapat beberapa pengertian diberikan kepada pendidikan bersepadu dan terdapat pelbagai dimensi kesepaduan dalam pendidikan. Pusat Perkembangan Kurikulum (PKK) (1990) mentakrifkan pendidikan bersepadu sebagai usaha berterusan yang menyepadukan proses penguasaan ilmu pengetahuan, kemahiran dan bahasa serta pemupukan nilai-nilai murni secara menyeluruh berlandaskan konsep pendidikan seumur hidup. Menurut Nik Azis (1995), pendidikan bersepadu merujuk kepada pendidikan yang memberi fokus kepada saling hubungan iaitu saling hubungan antara tubuh, pemikiran dan rohani; saling hubungan antara tanggungjawab kepada Pencipta, diri sendiri, persekitaran dan komuniti; saling hubungan antara pelbagai domain ilmu pengetahuan. Habsah (1999) mendefinisikan pendidikan bersepadu sebagai pendidikan yang berpaksikan ketuhanan dan bertujuan menghasilkan pelajar yang mempunyai sahsiah yang seimbang dari segi intelek, emosi, jasmani dan rohani. Usaha ke arah mencapai matlamat ini dibuat melalui penyepaduan ilmu pengetahuan, nilai murni dan akhlak, situasi pengajaran dan pembelajaran bersepadu yang merangkumi aspek kemahiran, bahasa, ko-kurikulum dan budaya sekolah.

Banyak pihak yang menyambut baik konsep pendidikan bersepadu dan cuba merealisasikan di pelbagai peringkat pendidikan bermula dari tahap pra-sekolah seperti Taman Asuhan Kanak-kanak Islam (TASKI) hinggalah ke peringkat pengajian tinggi. Realiti perlaksanaan konsep pendidikan bersepadu di Malaysia boleh dibahagikan kepada dua peringkat utama iaitu sekolah dan IPT. Malaysia telah berjaya menggubal satu falsafah pendidikan yang baik yang dikenali sebagai Falsafah Pendidikan Kebangsaan (FPK). Falsafah ini diterjemahkan kepada pembinaan kurikulum iaitu Kurikulum Bersepadu Sekolah Rendah

(KBSR) dan Kurikulum Bersepadu Sekolah Menengah (KBSM). Perkembangan terbaru menunjukkan bahawa Kementerian Pendidikan melakukan transformasi kurikulum kebangsaan dengan memperkenalkan Kurikulum Standard Sekolah Rendah (KSSR). Fokus KSSR adalah kepada 4M iaitu kemahiran membaca, menulis, mengira dan menaakul. Pembangunan KSSR adalah berasaskan prinsip-prinsip Kurikulum Bersepadu Sekolah Rendah (KBSR) dan berlandaskan Falsafah Pendidikan Kebangsaan (FPK) yang berhasrat untuk melahirkan insan yang seimbang, berfikiran kreatif, kritis dan inovatif melalui enam tunjang utama iaitu komunikasi, sains dan teknologi, perkembangan fizikal dan estetika, keterampilan diri, kemanusiaan, dan kerohanian, sikap dan nilai. KSSR mengekalkan kesemua prinsip KBSR iaitu pendekatan bersepadu, perkembangan individu secara menyeluruh, pendidikan saksama untuk semua murid dan pendidikan seumur hidup.

Pelaksanaan kurikulum bersepadu yang lebih jelas berlaku pada tahap menengah seperti di Sekolah Menengah Kebangsaan Agama (SMKA) atau Sekolah/Kelas Aliran Agama (KAA) di mana pelajar mengambil matapelajaran elektif Pengajian Islam seperti al-Quran dan Sunnah, Syariah Islamiah dan Tasawwur Islam. Bagi ibubapa yang tidak berpuas hati dengan kedalaman kandungan pengajian agama dan penguasaan Bahasa Arab di SMKA atau KAA, mereka menghantar anak-anak ke sekolah yang menawarkan kurikulum al-Azhar sama ada di bawah pengelolaan Kerajaan Negeri (Sekolah Menengah Agama Negeri - SMAN) atau orang ramai (Sekolah Menengah Agama Rakyat - SAR). Walau bagaimanapun, tindakan memasukkan beberapa atau sekelompok mata pelajaran pengajian Islam dalam satu sistem kurikulum bukanlah satu jaminan akan berlakunya proses pendidikan bersepadu.

Justeru, masih ramai pihak yang belum berpuas hati dengan pencapaian semasa sistem pendidikan arus perdana dan perkembangan pendidikan yang berlaku. Mereka terus mencari-cari pendidikan alternatif atau model kesepaduan yang lebih mantap dan diyakini mampu menghasilkan generasi baru yang benar-benar bersepadu. Perkembangan terbaru menunjukkan bahawa minat ibubapa kini mula tertumpu kepada sekolah yang menggabungkan tiga aspek secara serentak iaitu pengajian agama, akademik dan hafazan al-Quran.

Di peringkat IPT pula, beberapa usaha yang serius dilaksanakan melalui penubuhan beberapa Institut Pengajian Tinggi Awam dan Swasta seperti UIAM, KUIM, KUIS, dan Kolej Dar al-Hikmah (KDH). Institusi ini berhasrat untuk melahirkan generasi baru muslim yang berilmu, berwibawa, berakhlak dan profesional yang mampu mengangkat semula martabat bangsa dan ummah. Terdapat tiga institusi penting yang dikaitkan dengan konsep pendidikan dan kurikulum bersepadu di peringkat pengajian tinggi iaitu Universiti Islam Antarabangsa Malaysia (UIAM), Institut Pemikiran Islam dan Peradaban Antarabangsa (ISTAC) dan Universiti Sains Islam Malaysia (USIM). Melalui falsafah, visi dan misi masing-masing, setiap daripadanya menyatakan secara jelas bahawa mereka menawarkan sistem pendidikan bersepadu yang merujuk kepada kesepaduan ilmu wahyu dan ilmu pemerolehan yang berpaksikan prinsip *tauhid*. Walau bagaimanapun, konsep kesepaduan dan modus operandi setiapnya adalah berbeza (Sidek Baba, 2009). Taksonomi yang sedang diusahakan dalam penulisan ini adalah sebahagian daripada inisiatif untuk mencapai tujuan pendidikan bersepadu melalui aspek PdP dari peringkat yang paling rendah sehingga ke peringkat pengajian tertinggi.

DAPATAN DAN PERBINCANGAN

Analisis FGD telah menghasilkan 5 tema besar iaitu kefahaman makna pendidikan bersepadu dan PdP bersepadu, realiti pelaksanaan PdP bersepadu, latihan dan pendedahan PdP bersepadu, penilaian aplikasi Taksonomi FiZi dan cadangan penambahbaikan pelaksanaan pendidikan bersepadu dengan menggunakan Taksonomi FiZi. Setiap tema tersebut mengandungi beberapa sub tema yang tersendiri. Perincian setiap tema adalah sebagaimana berikut:

Tema 1: Kefahaman Makna Pendidikan Bersepadu dan Pengajaran dan Pembelajaran Bersepadu

Melalui FGD, semua peserta diminta untuk menjelaskan kefahaman masing-masing tentang konsep pendidikan bersepadu dan pengajaran dan pembelajaran (PdP) bersepadu. Daripada 20 peserta, 8 telah memberi maklumbalas dengan gaya kefahaman yang berbeza-beza. 3 peserta menjelaskan konsep pendidikan dan PdP bersepadu sebagaimana yang dikemukakan oleh pihak Kementerian Pendidikan Malaysia (KPM) yang melibatkan penerapan nilai-nilai murni atau akhlak untuk membina potensi insan secara seimbang dan harmoni; jasmani, emosi, rohani dan intelek (JERI) sebagaimana yang dihasratkan oleh Falsafah Pendidikan Kebangsaan (FPK). Berdasarkan analisis penyelidik, tema dan subtema bagi kefahaman makna pendidikan bersepadu dan PdP bersepadu dari peserta 1 hingga 20 adalah seperti jadual berikut:

Jadual 2 Kefahaman Makna Pendidikan Bersepadu dan PdP Bersepadu

Item	1	2	3	4	5	6	7	8	9	10	11	12	13	14	15	16	17	18	19	20
Makna Kesepaduan A1	/	/	/	/					/	/	/				/					
Kesepaduan KPM A1.1	/			/							/									
Kesepaduan Rencam A1.2	/		/													/				
Kesepaduan Agama & Akademik A1.3	/							/	/											

Kepelbagaian pandangan ini mengulang semula perbincangan sebelumnya bahawa terdapat beberapa pengertian diberikan kepada pendidikan bersepadu dan PdP bersepadu. Pandangan pertama sangat dekat dengan pengertian kesepaduan Pusat Perkembangan Kurikulum (PKK) (1990) yang mentakrifkan pendidikan bersepadu sebagai usaha berterusan yang menyepadukan proses penguasaan ilmu pengetahuan, kemahiran dan bahasa serta pemupukan nilai-nilai murni secara menyeluruh berlandaskan konsep pendidikan seumur hidup. Kefahaman ini sangat dekat dengan konsep JERI yang terdapat dalam Falsafah Pendidikan Kebangsaan (FPK). Pandangan kedua pula menepati makna kesepaduan yang umum luas dan rencam. Nik Azis (1996) menyatakan kesepaduan umum melibatkan lapan aspek berikut; kesepaduan dalaman, luaran, aktiviti, konteks, proses, strategi, peringkat dan kesepaduan penilaian. Justeru, makna PdP bersepadu dalam konteks ini adalah merujuk kepada pelbagai subjek dengan menggunakan pelbagai aktiviti dan turut mengambil kira perkara di luar silibus yang melibatkan realiti kehidupan pelajar. Walau bagaimanapun makna pendidikan bersepadu yang diangkat dalam penyelidikan ini ialah kesepaduan pendidikan moden dan pendidikan Islam (Tajul Ariffin 2002; Wan Mohd Noor 1998). Pendidikan bersepadu ini tidak lagi mengasingkan antara pendidikan asas agama yang bersifat fardu ain berasaskan dalil naqli dengan pendidikan ilmu aqli yang bersifat fardu kifayah berasaskan dalil aqli. Ini bermakna para guru YIK masih lagi memahami konsep pendidikan dan PdP bersepadu secara beragam dan tidak selaras. Pendefinisian yang jelas dan selaras tentang konsep pendidikan dan PdP bersepadu sangat penting untuk memastikan segala aktiviti dan program yang dilaksanakan oleh pihak sekolah selaras dan seiring dengan konsep pendidikan dan PdP yang dikehendaki.

Tema 2: Realiti Pelaksanaan Pengajaran dan Pembelajaran Bersepadu di YIK

Berdasarkan kefahaman sebelumnya, semua peserta diminta untuk menerangkan realiti pelaksanaan pendidikan bersepadu khusus dalam aspek PdP di sekolah masing-masing. 7 daripada 20 peserta telah memberi maklumbalas yang berbeza-beza. Kepelbagaian pandangan tersebut berkait dengan kefahaman makna PdP bersepadu sebelumnya, latar belakang pendidikan yang dilalui dan tempoh masa pengalaman menjadi guru. Dari 7 peserta tersebut, 5

daripadanya menyatakan bahawa mereka telah pun melaksanakan PdP bersepadu secara tidak langsung tanpa sedar (P4, P6, P13, P14), tidak menyeluruh (P10), tidak meluas (P4), tidak mendalam (P6), pada tahap rendah (P4) dan tidak dirancang (P6). Tema realiti pelaksanaan PdP bersepadu di YIK dari peserta 1 hingga 20 boleh diringkaskan sebagaimana dalam jadual matriks berikut:

Jadual 3. Realiti Pelaksanaan Pengajaran dan Pembelajaran Bersepadu di YIK

Item	1	2	3	4	5	6	7	8	9	10	11	12	13	14	15	16	17	18	19	20
Realiti Pelaksanaan B2			/		/				/		/	/	/						/	
Melaksanakan secara tidak langsung B2.1			/		/				/		/	/								
Tidak melaksanakan B2.2												/								
Melaksanakan secara sedar B2.3																			/	

Realiti pelaksanaan konsep pendidikan bersepadu di Malaysia boleh dibahagikan kepada dua tahap iaitu tahap sekolah dan tahap IPT. Sekolah aliran perdana yang menggunakan Kurikulum Standard Sekolah Rendah (KSSR) dan Kurikulum Standard Sekolah Menengah (KSSM) adalah berasaskan prinsip-prinsip Kurikulum Bersepadu Sekolah Rendah (KBSR) dan Kurikulum Bersepadu Sekolah Menengah (KBSM) sebelumnya yang juga berlandaskan Falsafah Pendidikan Kebangsaan (FPK). KSSR sebagai contoh, mengekalkan kesemua prinsip KBSR sebelumnya iaitu pendekatan bersepadu, perkembangan individu secara menyeluruh, pendidikan saksama untuk semua murid dan pendidikan seumur hidup (Bahagian Pembangunan Kurikulum KPM 2014). Apabila guru melaksanakan PdP berasaskan KSSM di sekolah, bermakna dia telah pun memenuhi konsep pendidikan bersepadu menurut pandangan KPM dan ini selaras dengan pandangan sub tema A1.1 sebelumnya. Inilah pandangan yang dikemukakan majoriti peserta dalam tema ini apabila menyatakan bahawa mereka telah melaksanakannya secara tidak langsung, tanpa merancang, tanpa sedar, secara tohor dan tidak meluas serta tidak menyeluruh. Jika dirujuk pada Taksonomi FiZi, proses kesepaduan tersebut berlaku pada tahap rendah atau sederhana sahaja khususnya oleh guru-guru lama yang berpengalaman dan mempunyai ilmu pendidikan ikhtisas.

Walau bagaimanapun ramai pihak yang belum berpuas hati dengan pelaksanaan konsep kesepaduan tersebut. Oleh sebab itu mereka memilih untuk menghantar anak-anak mereka ke ke sekolah yang menawarkan kurikulum pengajian agama (seperti kurikulum al-Azhar) serentak dengan KSSM seperti yang ditawarkan sekolah di bawah pengelolaan YIK. Walau bagaimanapun, tindakan memasukkan beberapa atau sekelompok mata pelajaran pengajian Islam dalam satu sistem kurikulum secara seiringan bukanlah satu jaminan akan berlakunya proses pendidikan bersepadu yang dikehendaki (Noor Hisham 2015). Perkembangan terbaharu menunjukkan bahawa minat ibubapa kini mula tertumpu kepada sekolah yang lebih serius menggabungkan tiga aspek secara serentak iaitu pengajian agama, akademik dan hafazan al-Quran seperti Maahad Tahfiz Sains (MTS) atau Maahad Sains Tok Guru (MSTG) yang juga dikelolakan oleh pihak YIK. Dengan kefahaman tersebut, peserta 12 menyatakan bahawa dia belum lagi memenuhi pelaksanaan PdP bersepadu di sekolah berkenaan dalam matapelajaran yang diajarnya iaitu matematik. Matapelajaran ini tidak mudah untuk dilaksanakan berdasarkan kefahaman PdP bersepadu dalam sub tema A1.3 di mana ilmu fardu kifayah (matematik) disepadukan dengan ilmu fardu ain (pengajian Islam). Namun pada masa yang sama, terdapat juga seorang peserta yang memahami konsep PdP bersepadu sebagaimana dalam sub tema A1.3 dan melaksanakannya secara sedar dan dirancang. Setelah diselidiki lanjut, peserta ini mempunyai latar belakang pengajian agama yang baik dan telah mengikuti

pengajian di IPT yang melaksanakan konsep pendidikan bersepadu yang sama. Tema ini berkesinambungan dengan tema sebelumnya. Cara faham yang berbeza tentang PdP bersepadu akan menyebabkan cara pelaksanaannya juga berbeza. Sebahagian besar peserta berpandangan bahawa mereka sudah melaksanakannya meskipun secara sederhana. Di sebalik semua itu, terdapat peserta yang telah melaksanakannya atas dasar tanggungjawab dan kewajipan serta mempunyai pengalaman mengenainya. Secara keseluruhan, hanya segelintir guru YIK yang melaksanakan konsep pendidikan dan PdP bersepadu mengikut kerangka penyelidikan.

Tema 3: Latihan dan Pendedahan PdP Bersepadu

Tema ini menerangkan tentang program latihan atau sebarang pendedahan yang dianjurkan oleh pihak-pihak tertentu mengenai PdP bersepadu di sekolah YIK. Daripada 20 peserta yang terlibat, 8 orang telah memberikan maklumbalas. Respons mereka secara mudah boleh dibahagikan kepada dua kelompok. Kelompok pertama menyatakan bahawa mereka pernah mendapat latihan atau pendedahan tentang pendidikan bersepadu khususnya dari pihak YIK atau ILDAN/ILPK (P10, P12, P14, P16). Untuk memudahkan kefahaman, sila rujuk jadual berikut untuk melihat tema latihan dan pendedahan PdP bersepadu dari peserta 1 hingga 20.

Jadual 4 : Latihan dan Pendedahan Pendidikan dan PdP Bersepadu

Item	1	2	3	4	5	6	7	8	9	10	11	12	13	14	15	16	17	18	19	20
Latihan dan Pendedahan C3										/	/	/	/	/	/	/				
Mendapat latihan atau pendedahan tentang PdP bersepadu C3.1										/		/		/		/				
Tidak mendapatkan sebarang latihan atau pendedahan tentang PdP bersepadu C3.2											/		/		/					

Berdasarkan Jadual sebelumnya, terdapat dua kelompok besar iaitu kelompok yang pernah mengikuti program latihan atau pendedahan tentang pendidikan dan PdP bersepadu yang dianjurkan oleh pihak luar khususnya Institut Latihan Perguruan Kelantan (ILPK) yang sudah dinaiktaraf menjadi Institut Latihan Darul Naim (ILDAN) pada tahun 2021. ILPK yang ditubuhkan pada 2015 berfungsi untuk meningkatkan profesionalisme keguruan guru-guru YIK berteraskan konsep Ubudiyah, Masuliyah dan Itqan (UMI) dalam semua aspek kehidupan. Dalam tempoh 6 tahun, ILPK telah menganjurkan pelbagai program latihan yang melibatkan semua guru-guru di bawah kelolaan YIK yang berjumlah sekitar 2,700 orang. Antara program yang berkait secara langsung dengan konsep pendidikan dan PdP bersepadu anjuran ILPK adalah kursus yang berkaitan tentang PengIslaman Ilmu, PengIslaman Pengajaran Sains, Projek Rintis Pembinaan Guru Bersepadu di samping penganjuran seminar berkaitan sama ada di peringkat kebangsaan atau antarabangsa. Bagi mereka yang lama bertugas di mana-mana sekolah YIK, berkemungkinan besar pernah menghadiri program-program latihan berkenaan. Manakala kelompok kedua pula ialah mereka yang tidak pernah mengikuti sebarang latihan atau pendedahan tentang pendidikan dan PdP bersepadu yang umumnya adalah guru-guru baharu menyertai sektor pendidikan di YIK. Penubuhan ILPK yang kemudiannya menjadi ILDAN adalah satu indikator jelas bahawa pihak berautoriti dalam bidang pendidikan di Kelantan memberi penekanan khusus untuk meningkatkan kualiti guru-guru YIK dalam pelbagai aspek termasuk dalam isu pendidikan bersepadu.

Tema 4: Penilaian Aplikasi Taksonomi FiZi

Tema ini sangat penting kerana ia memberi maklumbalas tentang pencapaian aplikasi Taksonomi Fizi dalam kalangan peserta terpilih untuk membantu pelaksanaan PdP bersepadu di sekolah YIK. Daripada 20 peserta, 18 daripadanya telah memberi maklumbalas yang boleh dibahagikan kepada tiga sub tema iaitu reaksi positif, negatif dan bercampur antara positif dan negatif. Pelaksanaan Taksonomi FiZi menghadapi pelbagai cabaran di lapangan sekolah. Antara cabaran tersebut ialah kedudukannya bukan sebagai satu elemen teras yang wajib dilaksanakan, sistem pendidikan semasa yang berorientasikan pencapaian peperiksaan dan ketidaksediaan guru atau keyakinan diri yang rendah untuk mengaplikasikannya dalam PdP. Penyelidik dimaklumkan bahawa kebanyakan guru akademik tidak memiliki kefahaman agama yang mantap kerana mereka bukan dari aliran pengajian agama. Dengan ini disimpulkan bahawa cabaran terbesar pelaksanaan PdP bersepadu menggunakan Taksonomi FiZi adalah kemampuan dan keinginan guru itu sendiri. Hanya guru yang berkemampuan (ilmu) dan memahami kepentingan konsep pendidikan bersepadu akan bersedia untuk mengorbankan masa dan tenaga untuk merealisasikannya dengan baik. Sila rujuk jadual berikut untuk melihat pola tema penilaian aplikasi Taksonomi FiZi dari peserta 1 hingga 20.

Jadual 5: Penilaian Aplikasi Taksonomi FiZi Bersepadu

Item	1	2	3	4	5	6	7	8	9	10	11	12	13	14	15	16	17	18	19	20
Penilaian Aplikasi Taksonomi FiZi D4	/	/	/	/	/	/	/	/	/	/	/	/	/	/	/	/	/	/	/	/
Reaksi Positif D4.1		/	/	/	/					/	/	/			/	/	/	/	/	/
Reaksi Negatif D4.2	/	/	/	/	/	/	/	/	/	/	/	/						/	/	/
Reaksi Bercampur D4.3				/								/	/				/			/

Berdasarkan Jadual tersebut, dirumuskan bahawa maklumbalas para peserta terhadap penggunaan Taksonomi FiZi dalam membantu PdP bersepadu adalah rencam. Majoriti kecil daripada mereka bersifat positif terhadap Taksonomi Fizi dalam membantu PdP bersepadu khususnya dari aspek kesannya kepada pelajar. Pelajar yang aktif secara mudah akan tertarik dengan konsep kesepaduan tersebut kerana mereka dapat melihat perkaitan yang lebih jelas tentang konsep ilmu, agama dan kehidupan. Ia menjadikan pelajar lebih berfikir dan merenung diri serta mengaitkannya dengan Tuhan dan kehidupan. Namun usaha ini tidak mudah kerana ia memerlukan persiapan keilmuan guru. Dari sini, timbul reaksi negatif guru kerana kebanyakan daripada mereka tidak mempunyai persiapan tersebut. Reaksi negatif menjadi lebih besar kerana realiti kekangan masa dan sistem pendidikan YIK yang masih lagi berorientasikan peperiksaan. Ini bermakna konsep kesepaduan yang diamalkan kebanyakan peserta masih berada pada tahap rendah dan sederhana. Taksonofi FiZi yang diaplikasikan memberi petunjuk yang jelas kepada prestasi tersebut. Berasaskan realiti tersebut, para guru banyak memberi cadangan dan saranan untuk memperbaiki lagi tahap PdP bersepadu di YIK yang akan dibincangkan dalam tema berikutnya.

Tema 5: Cadangan Penambahbaikan

Tema ini sangat penting untuk menambahbaik Taksonomi Fizi dalam membantu pelaksanaan konsep pendidikan dan PdP bersepadu di YIK. Dalam tema ini, 15 daripada 20 peserta telah memberi pelbagai cadangan penambahbaikan yang kemudiannya boleh dibahagikan kepada 6 sub tema berikut iaitu cadangan penambahbaikan bahan sumber, guru, pedagogi, pengurusan, sikap dan umum. Untuk memudahkan kefahaman, sila rujuk jadual berikut untuk melihat sub-sub tema yang lahir dari tema utama cadangan penambahbaikan dari peserta 1 hingga 20.

Jadual 6: Cadangan Penambahbaikan

Item	1	2	3	4	5	6	7	8	9	10	11	12	13	14	15	16	17	18	19	20
Cadangan Penambahbaikan E5	/	/	/	/	/	/	/	/	/	/	/	/	/	/	/	/	/	/	/	/
Cadangan Penambahbaikan Bahan Sumber E5.1							/	/	/	/	/	/	/	/	/	/	/	/	/	/
Cadangan Penambahbaikan Guru E5.2									/	/										/
Cadangan Penambahbaikan Pedagogi E5.3								/	/							/				
Cadangan Penambahbaikan Pengurusan E5.4	/									/	/			/						/
Cadangan Penambahbaikan Sikap E5.5							/								/	/			/	
Cadangan Penambahbaikan Umum E5.6		/																		

Jika diteliti kesemua cadangan yang dikemukakan, keseluruhannya menuju kepada penambahbaikan terhadap proses PdP bersepadu itu sendiri; bukannya kepada penambahbaikan terhadap Taksonomi FiZi yang dibangunkan. Sebahagian besar peserta menyatakan secara umum bahawa Taksonomi Fizi itu bagus dan membantu proses PdP bersepadu. Namun tumpuan mereka adalah lebih kepada cabaran untuk melaksanakan PdP bersepadu berbanding dengan mengaplikasikan Taksonomi FiZi. Mereka tidak begitu berminat untuk mengetahui tahap kesepaduan PdP yang disampaikan. Fokus mereka adalah bagaimana untuk melaksanakan PdP bersepadu. Justeru cadangan mereka berfokus kepada usaha untuk mendapatkan bahan PdP bersepadu yang boleh digunakan secara segera (dibekalkan dan bukan dibangunkan sendiri). Keperluan ini adalah berasaskan kepada kekangan masa, kesibukan guru dan keutamaan pencapaian peperiksaan berbanding perkara yang lain. Dengan lain perkataan, mereka berminat kepada penyelesaian segera. Namun ada juga guru yang mempunyai kesedaran tinggi yang sanggup untuk membuat persiapan sewajarnya seperti kesediaan untuk terus belajar bahkan melakukan penyelidikan. Sebahagian daripada peserta menggesa agar usaha ini diperkasakan (diwajibkan) kepada semua guru lain meskipun bermula dengan tahap kesepaduan rendah. Mereka mengaitkannya sebagai satu perjuangan dan kewajipan. Ini dibuktikan dengan cadangan-cadangan sikap yang diperlukan oleh guru-guru YIK untuk merealisasikan agenda tersebut. Satu lagi perkara yang perlu diangkat ialah kepentingan pihak ILDAN untuk memberi latihan dan pendedahan yang lebih banyak kepada guru-guru YIK tentang kepentingan konsep pendidikan bersepadu dalam konteks yang sebenar; bukannya kefahaman yang tohor dan ikut-ikutan.

Aplikasi Taksonomi FiZi di sekolah YIK merumuskan beberapa perkara yang sangat kritikal dan memerlukan perhatian semua pihak yang berkepentingan. Antara yang terpenting ialah kepentingan untuk memahami konsep kesepaduan yang tepat dalam bidang pendidikan (Tajul Ariffin 1988; Habsah 1999; Wan Mohd Nor 1998; Rahimah Embong 2008; Zetty Nurzuliana & Ab. Halim Tamuri 2014). Kesepakatan dan keselarasan dalam memilih makna dan konsep yang dipersetujui tentang kesepaduan pendidikan sangat penting kerana kefahaman

yang berbeza akan melahirkan amalan yang berbeza. Kajian ini telah membuktikan bahawa Taksonomi FiZi membantu guru dalam melaksanakan PdP bersepadu dan memberi kesan positif kepada para pelajar. PdP bersepadu membantu pelajar untuk melihat perkaitan yang bermakna antara ilmu yang dipelajari, agama dan kehidupan. Ia menjadikan pelajar berfikir secara kritikal, merenung diri dan mengaitkannya dengan Tuhan serta kehidupan.

Walau bagaimanapun, sebahagian daripada guru memberi kritikan dan menyatakan bahawa ia susah untuk dilaksanakan. Setelah diteliti lanjut, kesusahan tersebut adalah merujuk kepada kesukaran untuk melaksanakan PdP bersepadu itu sendiri; bukannya kesusahan mengaplikasi taksonomi tersebut. Ini terbukti apabila kesemua cadangan penambahbaikan yang dikemukakan tertumpu kepada penambahbaikan terhadap proses PdP bersepadu itu sendiri; bukannya kepada Taksonomi FiZi yang dibangunkan. Justeru, cabaran terbesar pelaksanaan PdP bersepadu menggunakan Taksonomi FiZi adalah pada kemampuan dan kewibawaan guru itu sendiri. Ini boleh difahami kerana sebahagian daripada guru akademik YIK tidak memiliki kefahaman agama yang mantap kerana mereka bukannya datang dari aliran pengajian agama. Situasi menjadi lebih sukar kerana peruntukan masa yang ada sangat terbatas. Pelaksanaan PdP bersepadu meskipun sekadar selitan yang ringkas tetap mengambil masa dan menyebabkan kandungan silibus yang dirancang gagal untuk dihabiskan. Meskipun sebahagian daripada guru memberi komentar yang negatif, majoriti guru yang terlibat mengiktiraf akan kebaikan Taksonomi Fizi dan kesan positifnya kepada para pelajar. Mereka juga bersemangat untuk melaksanakannya dan memberi pelbagai cadangan penambahbaikan yang keseluruhannya tertumpu kepada keperluan untuk mendapatkan bahan-bahan bersepadu yang boleh dimanfaatkan segera seperti modul, buku teks khusus, nota dan seumpamanya.

RUMUSAN DAN PENUTUP

Penyelidikan ini sekali lagi menyokong pelbagai dapatan kajian sebelumnya bahawa guru adalah faktor terpenting dalam menentukan kejayaan pelaksanaan konsep pendidikan dan PdP bersepadu. Secara keseluruhan, Taksonomi FiZi yang dibangunkan diterima oleh majoriti para peserta dan terbukti membantu mereka dalam melaksanakan PdP bersepadu. Namun pelaksanaannya menunjukkan bahawa masih banyak kelemahan yang perlu diatasi sama ada yang melibatkan persiapan guru, bahan pengajaran dan pengurusan kurikulum. Pelaksanaan Taksonomi FiZi ini adalah salah satu dari mata rantai usaha berterusan untuk mencapai matlamat yang lebih besar iaitu melaksanakan gagasan pendidikan bersepadu bagi melahirkan insan soleh-muslih yang berperanan besar dalam pembangunan ummah. Semoga hasil kajian ini dapat dimanfaatkan oleh pelbagai pihak yang berkaitan untuk meningkatkan lagi kualiti pendidikan negara khususnya dalam memartabatkan sistem pendidikan Islam di tanah air yang tercinta.

RUJUKAN

Al-Quran Al-Karim

- Abdul Samad al-Falimbani. 2010. Sairus Salikin (Perjalanan Orang yang Salik Kepada Allah) Juz. 1- Juz 4, Ahmad Fahmi bin Zamzam (pentahqiq), Banjarbaru: Darussalam Yasin
- Ah. Zakki .2014. Taksonomi transenden; paradigma baru tujuan pendidikan Islam. Jurnal Pendidikan Agama Islam 2(1): 2-25
- Amer, A. 2006. Reflections on Blooms Revised Taxonomy. Electronic Journal of Research in Educational Psychology. V4. page: 213–230.
- Bahagian Pembangunan Kurikulum, Kementerian Pendidikan Malaysia, (Laman Web Rasmi)..<http://web.moe.gov.my/bpk/v2/kssr/> 29 Januari 2014

- Bloom, B.S., (Ed.). 1956. *Taxonomy of educational objectives: The classification of educational goals: Handbook I, cognitive domain*. New York: Longman.
- Brenda Sugrue, C. (2002). Problems With Bloom's Taxonomy. Performance Express, 3.
- Enghoff, Henrik. (2009). "What is Taxonomy", *Soil Organisms*, Vol 81 (3) 2009. <http://id.wikipedia.org/wiki/Taksonomi>.
- Furst, E. J. 1981. *Bloom's Taxonomy of Educational Objectives for the Cognitive Domain: Philosophical and Educational Issues*. Review of Educational Research Winter, 51(4), 441–453.
- Gueguen, M. 2016. *A Measure of Middle School Students' Ability To Think Critically When Exposed To Historical Thinking Pedagogy*. Loyola University Chicago.
- Habsah Ismail. 1999. Kefahaman guru tentang konsep pendidikan bersepadu dalam KBSM. Tesis Ph.D. UKM. Bangi.
- Jason Barney 2020. Bloom's Taxonomy and the Purpose of Education August 15, 2020. <https://educationalrenaissance.com/2020/08/15/blooms-taxonomy-and-the-purpose-of-education/>.
- Long, N., Idris, R., & Malim, T. 2015. Analisis Taksonomi Bloom Dalam Penilaian Vokasional Cadangan Satu Taksonomi Baru.
- Mike, G. &. 2013. Classroom Practice Still Blooming After Almost 60 Years: News.
- Mohd Syaubari dan Ahmad Yunus. 2016. Elemen kemahiran berfikir aras tinggi (KBAT) di dalam amalan pengajaran guru pendidikan Islam menurut Imam Ghazali. *Jurnal Sultan Alauddin Sulaiman Shah*. 3(2): 80-91
- Mohd Zaidi Ismail. (2014). *Islam & Higher-Order Thinking: An Overview*. Kuala Lumpur: Penerbit IKIM.
- Nik Azis Nik Pa. 1995. Penghayatan matematik: perkembangan profesional KBSR & KBSM. Kuala Lumpur: Dewan Bahasa dan Pustaka.
- Nik Azis Nik Pa. 1996. Kesepaduan dalam pendidikan matematik. Kuala Lumpur: Jabatan Pendidikan Islam dan Moral Kementerian Pendidikan Malaysia.
- Noor Hisham Md Nawawi. 2015. Perjuangan Pendidikan; Dari Kesepaduan Ke Islamisasi. Kota Bharu: Universiti Malaysia Kelantan
- Noor Hisham Md Nawawi. 2018. *Pengenalan Kaedah Penyelidikan Islam; Gagasan dan Amalan*. Kota Bharu: Universiti Malaysia Kelantan
- Noor Hisham Md Nawawi. 2020. Taksonomi Bloom; satu semakan semula. Prosiding *International Conference on Education Research 2020*. Anjuran Institut Pendidikan Guru Kampus Pendidikan Islam, 15-16 Disember 2020.
- Noor Hisham Md Nawawi. 2021. Pembinaan Taksonomi Kerohanian; Inisiatif Awal. *Jurnal TAMU (Tinta Artikulasi Membina Ummah, Vo. 7(7) Dis: 12-23*
- Nursyahirah Wahidah Masrom, Mahyuddin Hashim, Noorhayati Hashim & Fariza Puteh Behak. 2018. Kedudukan Taksonomi Bloom Menurut Perspektif Islam. *Journal of Quran Sunnah Education and Special Need* 1(1): 18-26.
- Paul, B. R., & Elder, L. 2006. *The Miniature Guide to Critical Thinking: Concepts & Tools*. Pusat Perkembangan Kurikulum. 1990. Pukul latihan kurikulum bersepadu sekolah menengah (KBSM). Kuala Lumpur: Dewan Bahasa dan Pustaka
- Rahimah Embong & Solehah Yaacob. 2008. The Concept of An Integrated Islamic Curriculum and Its Implications for Contemporary Islamic Schools. Paper presented at the International Conference in Islamic Republic, Iran
- Sidek Baba. 2009. The Integrated Approach in Malaysian Education: The International Islamic University as a Model. *Journal Pendidikan Islam* 13(2):87-99.
- Suliswiyadi. 2020. Hierarki ranah pembelajaran afektif pendidikan agama Islam dalam perspektif taksonomi Qur'ani. *Jurnal Tarbiyatuna* 11 (1): 61-76

- Tajul Ariffin dan Nor Aini. 2002. Paradigma pendidikan bersepadu: perkembangan dua dekad. Prosiding Pendidikan dan Pembangunan Manusia. Bangi: UKM
- Tajul Ariffin Noordin. 1988. Konsep asas pendidikan sepadu. Kuala Lumpur: Nurin Enterprise.
- Wan Mohd Nor Wan Daud. 1998. *The educational philosophy and practice of Syed Muhammad Naquib Al-Atassi; an exposition of the original concept of islamization*. Kuala Lumpur: ISTAC.
- Zetty Nurzuliana Rashed, & Ab. Halim Tamuri. (2014). Melahirkan Generasi Al-Quran Melalui Kurikulum Pendidikan Integrasi Dan Holistik Jabatan Agama Islam Selangor (JAIS). E – Jurnal Penyelidikan Dan Inovasi, 1(2): 74-83.



Automatic Standardization of Arabic Dialects for Machine Translation

Abidrabbo Alnassan
Jean Moulin Lyon 3 University
Linguistics Research Center - Corpus, Discourse and Societies
ILCEA4-CREO (Grenoble Alpes University)
abidrabbo.alnassan@univ-lyon3.fr

ABSTRACT

Based on an annotated multimedia corpus, television series Marāyā 2013, we dig into the question of “automatic standardization” of Arabic dialects for machine translation. Here we distinguish between rule-based machine translation and statistical machine translation. Machine translation from Arabic most of the time takes standard or modern Arabic as the source language and produces quite satisfactory translations thanks to the availability of the translation memories necessary for training the models. The case is different for the translation of Arabic dialects. The productions are much less efficient. In our research we try to apply machine translation methods to a dialect/standard (or modern) Arabic pair to automatically produce a standard Arabic text from a dialect input, a process we call “automatic standardization”. we opt here for the application of “statistical models” because “automatic standardization” based on rules is more hard with the lack of “diglossic” dictionaries on the one hand and the difficulty of creating linguistic rules for each dialect on the other. Carrying out this research could then lead to combining “automatic standardization” software and automatic translation software so that we take the output of the first software and introduce it as input into the second one to obtain at the end a quality machine translation. This approach may also have educational applications such as the development of applications to help understand different Arabic dialects by transforming dialectal texts into standard Arabic.

Keywords: Arabic dialect; Syrian dialect; Automatic standardization; Modern Standard Arabic; Machine translation

INTRODUCTION

The Arabic language is a collection of varieties: Standard Arabic (SA) or Classical Arabic (CA), the language used in the Quran as well as in numerous literary texts; Modern Standard Arabic (MSA), the formal and official language of the Arab World; and Arabic dialects (AD), the commonly used informal native varieties. SA differs significantly in its grammatical properties from ADs. ADs have no standard orthographies and rules, they differ from each other and currently have an increasing presence on the web.

Arabic NLP researches, which focused mostly on SA and MSA, is now dealing more with ADs, especially when the DARPA⁷³ launched, in October 2011, the Broad Operational Language Translation (BOLT) program to attempt to create new techniques for automated translation and linguistic analysis that can be applied to the informal genres of text and speech common in online and in-person communication. Machine translation of ADs is a real challenge because of the lack of dialectal linguistic resources while SA and MSA has a wealth of resources in terms of morphological analyzers, disambiguation systems, annotated data, and parallel corpora.

⁷³ Defense Advanced Research Projects Agency

Based on an annotated multimedia corpus, television series *Marāyā* 2013, we dig into the question of “automatic standardization” of Arabic dialects for machine translation. Here we distinguish between rule-based machine translation and statistical and neural machine translation. Rule-based machine translation software relies on the use of many linguistic rules and large volumes of dictionary entries for each language pair. The software iterates through the text to be translated and creates an intermediate representation from which the translation is generated. This process requires the use of voluminous dictionaries, syntactic, morphological and semantic data, and numerous linguistic rules.

Statistical machine translation software translates using auto-constructed “statistical models” from monolingual and bilingual corpora. The construction of these “statistical models” requires the prior existence and availability of large volumes of translated texts (translation memories) to train the model to generate the translation.

Neural machine translation, on the other hand, is processed through a neural network where each neuron is a mathematical function that processes data. The initial translation training is done by feeding examples into the neural network and making adjustments based on how much error in the output there was. The network is continually used and continue to fine-tune itself to provide better results.

Machine translation from Arabic most of the time takes standard or modern Arabic as the source language and produces quite satisfactory translations, thanks to the availability of the translation memories necessary for training the models. The case is different for the translation of Arabic dialects. The productions are much less efficient.

In our research we try to apply machine translation methods to a dialect/standard (or modern) Arabic pair to automatically produce a standard Arabic text from a dialect input, a process we call “automatic standardization” versus “automatic translation” or “machine translation”. "automatic standardization" is done in one direction: informal or non-standard variety to formal or standard variety of the same language while “automatic translation” is done between different languages regardless of the direction of the process. The other process which goes from the standard variety to the non-standard variety of the same language may be called "automatic destandardization".

We aim through our research to develop a strategy to enrich linguistic resources and parallel ADs-MSA corpora by involving a huge number of human resources not yet involved in this process. We opt here for the application of "statistical models" because "automatic standardization" based on rules is more hard with the lack of standard orthographies for ADs, their numerous varieties, the absence of "diglossic" dictionaries and the difficulty of creating linguistic rules and dedicated tools for each dialect.

PREVIOUS WORK

Previous research on ADs machine translation has focused on mapping AD input words into MSA equivalents before translating. Researchers have used different techniques to do that. Chiang et al. (2006) built a parser for spoken Levantine Arabic (LA) transcripts using an MSA treebank. They used an LA-MSA lexicon in addition to morphological and syntactic rules to map the LA sentences to MSA. Riesa and Yarowsky (2006) built a statistical morphological segmenter for Iraqi and Levantine speech transcripts, and showed that they outperformed rule-based segmentation with small amounts of training. Abo Bakr et al. (2008) suggested a hybrid,

rule-based and statistical, system to map Egyptian Arabic to MSA, using morphological analysis on the input and an Egyptian-MSA lexicon. Sawaf (2010) normalized the dialectal words in a hybrid machine translation system. Salloum and Habash (2011) also mapped AD to MSA.

Some tools exist for preprocessing and tokenizing Arabic text with a focus on ADs. MAGEAD (Habash and Rambow, 2006) is a morphological analyzer and generator that can analyze words into their root/pattern and affixed morphemes, or generate a word in the opposite direction. Amazon's Mechanical Turk (MTurk) help creating annotated resources for computational linguistics. It is an online marketplace that allows "Requesters" to create simple tasks requiring human knowledge, and have them completed by "Workers" from all over the world. Zaidan and Callison-Burch (2011) created the Arabic Online Commentary (AOC) dataset by crawling the websites of three Arabic newspapers⁷⁴, and extracting online articles and readers' comments⁷⁵. Over 100k sentences from the AOC were annotated by native Arabic speakers on MTurk to identify ADs and dialect level in each one. The collected labels were used to train automatic dialect identification systems. Laith H. Baniata et al (2018) study the problem of employing a neural machine translation model to translate ADs to MSA. They propose the development of a multitask learning model which shares one decoder among language pairs, and every source language has a separate encoder.

SPOKEN ARABIC VS STANDARD ARABIC

In spontaneous oral communication, the letter (ق: qa) of SA is pronounced (أ: 'a) in some ADs, which can make it difficult, out of context, to determine the word we hear. This difference in pronunciation between spoken Arabic and standard Arabic mobilizes on the one hand the writing of the word produced orally and on the other its meaning in SA.

ق(qa) → أ('a)
قلم(qalam: pen) → ألم('alam: pen "in dialect" or pain "in SA")⁷⁶

In some cases, the new word heard is even non-existent in SA.

ق(qa) → أ('a)
قرار(qarār: decision) → أَرَار('arār: decision "in dialect" but there is no meaning to this pronunciation in SA)

A Syrian speaker and a Lebanese or Jordanian speaker can understand each other if both express themselves in their dialectal Arabic, because they are from neighboring linguistic cultures. However, a Syrian and a Moroccan cannot easily communicate through their dialect. There, MSA is essential (Alnassan, 2017). "Automatic standardization" therefore is not only important for the translation of ADs into other foreign languages, but also for creating a passage between the different ADs themselves.

Research on ADs machine translation is mainly based on written productions. The enrichment of machine translation tools therefore also presupposes the use of oral productions.

⁷⁴ The three newspapers are: 1) Al-Ghad (الغد), a Jordanian newspaper (www.alghad.com), 2) Al-Riyadh (الرياض), a Saudi newspaper (www.alriyadh.com), 3) Al-Youm Al-Sabe' (اليوم السابع), an Egyptian newspaper (www.youm7.com).

⁷⁵ The commentary data consists of 3.1M segments, corresponding to 52.1M words.

⁷⁶ We follow for the transliteration the system of the Arabica journal : (lettees : ء: ' , ب: b, ت: t, ث: t̤, ج: j, ح: ḥ, خ: ḫ, د: d, ذ: d̤, ر: r, ز: z, س: s, ش: š, ص: ṣ, ض: d̤, ط: t̤, ظ: z, ع: ' , غ: ḡ, ف: f, ق: q, ك: k, ل: l, م: m, ن: n, هـ: h, و: w, ي: y. Short vowels : ا: a, أُ: u, إ: i. Long vowels : آ: ā, ū, ī).

It is for this reason that our study relied on a television corpus (Marāyā 2013) in which most of the speech is in the Syrian dialect of Damascus.

MARĀYĀ 2013

Marāyā is a Syrian television series whose first season was broadcast in 1982. Very popular in Syria and the Arab world, this series deals ironically, and sometimes satirically, with themes relating to Syrian daily, social and political life. Marāyā 2013 is the last season of this series. The corpus includes all the thirty episodes broadcast on the Algerian channel Aš-šurūq TV. The average length of each episode is eighteen minutes, while it was around forty minutes in previous seasons. Although the Damascus dialect is the main language used, dialects from other Syrian regions may appear depending on the characters. Similarly, SA and MSA arises from time to time and exceptionally occupies the entirety of episode 25 in which the text is narrative.

Analysis of the lexicon of Marāyā 2013

The construction and analysis of Marāyā 2013 were initially carried out within the framework of previous research in Arabic language didactics (Alnassan, 2016). The speeches of the characters in the videos were transcribed and annotated using the ELAN (EUDICO Linguistic Annotator)⁷⁷ tool. The analysis of the transcripts was implemented in two steps:

- The first consisted of a statistical and descriptive analysis to define the nature of the lexical elements of the corpus and their distribution according to categories (according to lexicon proximity to SA/MSA) and groups (nouns, verbs, adjectives, ..., etc.);
- The second was based on a linguistic analysis (morphological, phonetic and semantic) which aimed to identify useful elements for the improvement of Arabic language teaching manuals.

The statistical analysis showed that 60% of the lexical elements of the corpus studied are common in SA/MSA and in the Syrian dialect (SD). However, at the level of the construction of the sentence, the phonetic aspect and the semantics in context, the two systems will be even more differentiated.

Through morphological and semantic analysis, we have been able to distinguish:

- Lexical elements that have the same meaning and the same form in SA/MSA and in dialect (أخي: 'hī: my brother);
- Lexical elements that have undergone slight modifications between SA/MSA and the dialect (letters or/and vowels), retaining the same meaning (كثير/كثير: kaṭīr/ktīr: many);
- Lexical elements which have the same form in SA/MSA and in dialect but whose meaning is different between the two registers (بكرة: bukraḥ: “the time just before sunrise” in SA/MSA / “tomorrow” in Syrian dialect).

We also distinguish at the sentence level:

- Constructions which have the same components in SA/MSA and in dialect and which produce the same meaning (إن شاء الله: 'in šā' Allāh: God willing);
- Constructions of lexical elements belonging to SA/MSA, but which are used only in dialectal context (أمر عيوناك: 'amr 'yūnak: “as you wish!/ at your service”, in the sense of obeying an order or responding to a request kindly.);
- Dialectal constructions containing lexical items related to SA/MSA, retaining the same meaning as the original SA/MSA construction (تعد للمية أبيل ما: t'idd lal-miyyih 'bil mā...:

⁷⁷ ELAN is an annotation tool that allows you to create, edit, view and search complex annotations for audio or video data. <https://archive.mpi.nl/tla/elan>.

count to a hundred before doing something, the equivalent standard expression is تَعُدُّ لِلْمِئَةِ قَبْلَ أَنْ...: ta'uddu lil-mi'ah qabla 'an...);

- Constructions containing lexical elements related to SA/MSA, but which only exist and have a meaning in dialectal context (تِسْتَوِطِي حَيْطِي: tistawī ḥiyī: "you see it low, my wall/roof"⁷⁸, in the sense of challenging someone's contemptuous look at you).

Phonetic analysis allowed us to identify seven letters of SA/MSA that can be pronounced differently in the regional dialect of Damascus. The following table shows, with examples, how to pronounce these letters in different contexts. (Alnassan, 2016b)

Abbreviations:

SA: Standard Arabic

L: letter in Arabic script

RdD: Regional dialect of Damascus

T: Transliteration of the Arabic letter

Tra: Translation of the example in English

Table 1. Arabic letters pronounced differently in RdD

SA letter		Pronunciation in RdD		Example	Original word
L	T	L	T	Word : T : Tra	Word : T
ث	t	ث	t̤	مَثَلَت : <i>Muṭallat</i> : triangle	مَثَلَت : <i>Muṭallat</i>
		ت	t	مِثْل : <i>mitil</i> : like	مِثْل : <i>mitil</i>
		س	s	مَسَلًا : <i>masalan</i> : for example	مَسَلًا : <i>maṭalan</i>
ذ	d	ذ	d̤	ذَنْب : <i>di'b</i> : wolf	ذَنْب : <i>di'b</i>
		ز	z	إِزْن : <i>'izin</i> : permission	إِذْن : <i>'iḏn</i>
		د	d	إِدْن : <i>'idin</i> : hear	أَدْن : <i>'udun</i>
ص	ṣ	ص	ṣ	صَحِيح : <i>ṣaḥiḥ</i> : true	صَحِيح : <i>ṣaḥiḥ</i>
		س	s	سَدِّئِنِي : <i>saddi'nī</i> : believe me !	سَدِّئِنِي : <i>ṣaddiqnī</i>
ض	ḍ	ض	ḍ	مَرِيض : <i>marīḍ</i> : ill	مَرِيض : <i>marīḍ</i>
		ز	z	مَزْبُوط : <i>mazbūṭ</i> : absolutely	مَضْبُوط : <i>maḍbūṭ</i>
ظ	ẓ	ظ	ẓ	مُظَاهَرَة : <i>muẓāharah</i> : demonstration	مُظَاهَرَة : <i>muẓāharah</i>
		ض	ḍ	ضَهْر : <i>ḍahr</i> : back	ظَهْر : <i>ẓahr</i>
		ز	z	غَلِيظ : <i>galīẓ</i> : heavy / annoying	غَلِيظ : <i>galīẓ</i>
ق	q	ق	q	حَدِيقَة : <i>ḥadiqah</i> : garden / park	حَدِيقَة : <i>ḥadiqah</i>
		أ	'	أَدِيم : <i>'adīm</i> : ancient	قَدِيم : <i>qadīm</i>
		/	g	أَبُو قَاسِم : <i>'abū gāsīm</i> : the father of Gāsīm	أَبُو قَاسِم : <i>'abū gāsīm</i>

From these observations, we can imagine the difficulty of carrying out rule-based machine translation or “automatic standardization” of ADs. For this reason, we think that creating and continuously enriching AD-MSA parallel corpora can, with the help of computer tools, considerably advance research in the machine translation of ADs. Audio-visual resources

⁷⁸ This expression is typically metaphorical. It represents two very distinct situations according to the meanings of the word “حَيْطِي: ḥiyī: my wall/my roof” in the Syrian dialect. By the first meaning “حَيْط: ḥiyṭ: wall”, we imagine two neighbors for whom there is a wall separating their house. If one of the two is intrusive and the wall is high, he cannot do anything to disturb his neighbor. On the other hand, if this wall is low, he can easily overcome it and interfere in the affairs of the other. Here, the latter, angry, can use the expression “تِسْتَوِطِي حَيْطِي: tistawī ḥiyī” while they are arguing. In the second case where the meaning is “حَيْط: ḥiyṭ: roof”, the expression refers to a situation where the roof of someone's house is too low so that anyone can climb it and then gain access to the inner courtyard. The metaphor of this expression most often refers to the first image.

must also be taken into account in this process. Most current research focuses on textual resources.

ADs-MSA PARALLEL CORPORA CREATION

Researchers in machine translation of ADs most often use methods that pivot through MSA. Harrath et al. (2017) for example show in a survey eight research works out of thirteen pivoting through MSA to translate ADs into English. Some works are based on open source parallel corpora like what can be found on OPUS⁷⁹ (the Open Parallel Corpus). Others build their own corpus.

For our work, we have tried to see if we can find on OPUS an ADs-MSA parallel corpora. By searching on OPUS, we were able to find voluminous resources dealing with the Arabic language. However, almost all the resources found are related to the MSA. The following table shows some of the information obtained by running a query to find Arabic-English parallel corpora. The complete result of our query can be found in the appendix.

Table 2. Some Arabic-English/English-Arabic corpora on OPUS

Corpus	Arabic-English		English-Arabic	
	Sentence pairs	Words	Sentence pairs	Words
United Nations Parallel Corpus	16,637,291	832.98M	20,044,653	904.08M
OpenSubtitles v2018	25,855,525	339.10M	29,823,188	356.14M
Tanzil	184,894	13.02M	187,052	13.07M
TED2020 v1	397,962	12.52M	407,595	12.54M
tico-19 v2020-10-28	3,070	0.14M	3,071	0.14M
WikiMatrix v1	999,763	41.98M	999,763	41.98M
wikimedia v20210402	374,437	31.49M	407,543	31.84M
Wikipedia	146,131	5.34M	151,136	5.38M

By searching for corpora containing ADs, we were able to identify two dialects listed among the source languages; the Syrian dialect “ar-SY(Arabic)” and the Tunisian dialect “ar-TN(Arabic)”. No dialect has been listed in the target languages. We then made the request to obtain the corpus containing the translations of the Syrian dialect “ar-SY(Arabic)” into MSA (which is represented in OPUS as “ar(Arabic)”) and then the corpus containing the translations of the Tunisian dialect “ar-TN(Arabic)” into MSA. The results were as follows:

Table 3. ar-SY(Arabic)-MSA corpora on OPUS

Search & download resources: show all versions

Language resources: click on [tmx | moses | xces | lang-id] to download the data! (raw = untokenized, ud = parsed with universal dependencies, alg = word alignments and phrase tables)

corpus	doc's	sent's	ar tokens	ar_SY tokens	XCES/XML	raw	TMX	Moses	mono	raw	ud	alg	dic	freq	other files
Ubuntu v14.10					xces ar ar_SY	ar ar_SY	tmx	moses	ar ar_SY	ar ar_SY			dic	ar ar_SY	sample
total	0	0	0	0	0	0	0	0							

color:

size (src+trg): 16.4k 32.8k 65.5k 0.1M 0.3M 0.5M 1.0M 2.1M 4.2M 8.4M 16.8M 33.6M 67.1M 134.2M

⁷⁹ OPUS is a growing collection of translated texts from the web. : <https://opus.nlpl.eu/>

Table 4. ar-TN(Arabic)-MSA corpora on OPUS

Search & download resources: | | show all versions

Language resources: click on [tmx | mooses | xces | lang-id] to download the data! (raw = untokenized, ud = parsed with universal dependencies, alg = word alignments and phrase tables)

corpus	doc's	sent's	ar tokens	ar_TN tokens	XCES/XML	raw	TMX	Moses	mono	raw	ud	alg	dic	freq	other files
GNOME v1	1	0.9k	3.7k	7.2k	xces ar ar_TN	ar ar_TN	tmx	mooses	ar ar_TN	ar ar_TN		alg smt		ar ar_TN	sample
total	1	0.9k	3.7k	7.2k	0.9k		0.7k	0.9k							

color: 16.4k 32.8k 65.5k 0.1M 0.3M 0.5M 1.0M 2.1M 4.2M 8.4M 16.8M 33.6M 67.1M 134.2M

By consulting the tmx version of the two corpora obtained, we were able to discover that the corpus for the Syrian dialect was an empty corpus, while the corpus which was supposed to contain the Tunisian dialect actually contained only words and sentences in MSA accompanied by their equivalent in MSA too. It was therefore not a Tunisian dialectal source language translated into MSA as a target language but rather a source in MSA produced by a Tunisian or in Tunisia and its equivalent in MSA as the target language. Here is an example of the content of this corpus :

Table 5. ar-TN(Arabic)-MSA tmx content

```

64 <tu>
65 <tuv xml:lang="ar"><seg>أنشطة مسلية</seg></tuv>
66 <tuv xml:lang="ar_TN"><seg>اذهب إلى الأنشطة المسلية</seg></tuv>
67 </tu>
68 <tu>
69 <tuv xml:lang="ar"><seg>أنشطة مسلية مختلفة.</seg></tuv>
70 <tuv xml:lang="ar_TN"><seg>أنشطة مسلية و متعددة</seg></tuv>
71 </tu>
72 <tu>
73 <tuv xml:lang="ar"><seg>هندسة</seg></tuv>
74 <tuv xml:lang="ar_TN"><seg>الهندسة</seg></tuv>
75 </tu>
76 <tu>
77 <tuv xml:lang="ar"><seg>الأنشطة الهندسية</seg></tuv>
78 <tuv xml:lang="ar_TN"><seg>الأنشطة الهندسية</seg></tuv>
79 </tu>
80 <tu>
81 <tuv xml:lang="ar"><seg>نشاطات آكل الأعداد</seg></tuv>
82 <tuv xml:lang="ar_TN"><seg>اذهب إلى أنشطة قاضم الأرقام</seg></tuv>
83 </tu>
84 <tu>
85 <tuv xml:lang="ar"><seg>أكل الأعداد هو مجموعة ألعاب حسابية</seg></tuv>
86 <tuv xml:lang="ar_TN"><seg>قاضم الأرقام هي ألعاب لممارسة الحساب</seg></tuv>
87 </tu>
88 <tu>
89 <tuv xml:lang="ar"><seg>استخدام لوحة المفاتيح</seg></tuv>
90 <tuv xml:lang="ar_TN"><seg>استخدام لوحة المفاتيح</seg></tuv>
91 </tu>

```

We also noticed the existence of an "ara (arabic)" in the list of source languages and which does not exist in the list of target languages. Looking also at the tmx version of the parallel corpus for the language pair ara(Arabic)-MSA, we found that these two varieties are only MSA.

Table 6. ara(Arabe)-MSA corpora on OPUS

Search & download resources: show all versions

Language resources: click on [tmx | moses | xces | lang-id] to download the data! (raw = untokenized, ud = parsed with universal dependencies, alg = word alignments and phrase tables)

corpus	doc's	sent's	ar tokens	ara tokens	XCES/XML	raw	TMX	Moses	mono	raw	ud	alg	dic	freq	other files
GNOME v1	1	0.6k	1.7k	1.6k	xces ar ara	ar ara	tmx	moses	ar ara	ar ara		alg smt			sample
total	1	0.6k	1.7k	1.6k	0.6k		0.4k	0.6k							

color:

size (src+trg): 16.4k 32.8k 65.5k 0.1M 0.3M 0.5M 1.0M 2.1M 4.2M 8.4M 16.8M 33.6M 67.1M 134.2M

To create their own corpus, some researchers use MTurk (Zaidan and Callison-Burch: 2011a,b; Zbib et al.: 2012). The idea is to create a parallel corpus by hiring non-professional translators and annotators to translate or annotate the sentences that were labeled as being ADs or MSA in documents collected from the web.

This method, from our point of view, is limited because:

- It is based on the work of a small number of contributors (translators or annotators);
- It is costly in terms of financial investment.
- The work is not durable and the enrichment of the corpus is not continuous.
- It is often based on the analysis of written documents.

Our work on Marāyā 2013 pushed us to reflect on methods that may allow us to build big textual corpora based essentially on audio-visual elements. Collecting subtitle texts from films, for example, does not provide this opportunity because in this case the text does not accurately represent the language content of the video. The transcription of the dialogues of Marāyā 2013 series was done manually and took a long time despite the fact that the average duration of each episode was around eighteen minutes. The other seasons of Marāyā had an average duration of forty-five minutes for each episode. We can so imagine how much time and money an individual researcher must spend to manually transcribe the remaining eighteen seasons of Marāyā, where each season contains at least thirty episodes. Automatic video transcription tools (speech to text tools) are not efficient enough for the Arabic language, especially when it comes to ADs.

The creation of textual resources from audio or audio-visual resources cannot therefore be carried out within the framework of individual work, which is our current case. In the same way, creating large ADs-MSA corpora requires the contribution of a very large number of contributors who are able to bring their help to advance this work.

Development of applications and platforms for the massive transcription and standardization of ADs.

During our computer-assisted translation (CAT) courses, we invite our students to practice using open source CAT applications and platforms. This practice allows the student to become familiar with these CAT tools. It also contributes to the continuous enrichment of translation memories (TM) which eventually become parallel corpora. The only problem is that these parallel corpora are not accessible to users. In other words, the service is provided free of charge, an individual user can retrieve the TM of his present work, but the parallel corpus produced by all users is not accessible.

To circumvent this problem we imagine the following scenario:

- IT developers or web developers build a web application or a platform allowing the entry of a word, an expression or a sentence in AD, define which AD it belongs to, then standardize it into MSA;
- This web application or platform must be unique and centralized to avoid duplication of data collected by users.

- The application must be accessible for free
- In educational and higher education institutions, we develop introductory and practical courses for the standardization of ADs into MSA.
- The practical part is done using the above-mentioned application or platform.
- Each user can retrieve the result of his current work to be able to develop his own resources;
- Each user can also download the global parallel corpus produced and enriched continuously by all users.
- This possibility of downloading the global parallel corpus may also be available to researchers in DAs and MSA.
- Researchers may also contribute to the development of the application or the platform, or to the development of output evaluation tools, for example.

Through this approach, researchers in dialectology, translation and machine translation of ADs will have an additional resource to those that already exist. A large ADs-MSA parallel corpus, built by a large number of contributors who will not necessarily be translators⁸⁰. If only students from the Arabic language departments of all the universities in the Arab world participate in this work, we will very quickly have the ADs-MSA parallel corpus which we hope to obtain. Such a corpus can help very considerably in the development of the statistical and neural models for ADs machine translation, and before that, the development of statistical and neural models for the automatic standardization of ADs.

In the same way, we can also develop a unique application or platform for the massive transcription of audio and audio-visual resources where the speeches are in ADs. The textual resources obtained by such an approach can be the basis on which the users of the manual standardization application will work.

CONCLUSION

Through this brief presentation of the difficulties related to the ADs machine translation, and of the work carried out and in progress in this field, we can come back to the idea that we really need to develop methods and tools to fill the lack of resources for ADs. We have seen that there is currently a significant lack of monolingual dialect corpora based on audio or audio-visual resources. There is also a significant lack in ADs-MSA parallel corpora necessary for training statistical or neural models in ADs machine translation systems.

The solutions we propose: developing a unique application or platform for the massive transcription of audio or audio-visual data which are in ADs, then another application or platform for the standardization of ADs, can significantly help to create and enrich continuously textual resources and large parallel ADs-MSA corpora. We can thus involve a very large number of participants who are not yet involved in this kind of practice while they can help without it being expensive in terms of time and money.

Carrying out this project could then lead to combining "automatic standardization" software and automatic translation software to obtain at the end a quality ADs machine translation.

⁸⁰ Native speakers of the different ADs, even if they do not know any other foreign language, can participate in this standardization work because SA and MSA are learned in school from childhood.

This approach may also have educational applications such as the development of applications to help understanding different ADs by transforming dialectal texts into standard Arabic.

REFERENCES

- Abo Bakr, H., Shaalan, K., & Ziedan, I. (2008). A Hybrid Approach for Converting Written Egyptian Colloquial Dialect into Diacritized Arabic. In *The 6th International Conference on Informatics and Systems, INFOS2008*. Cairo University.
- Alnassan, A. (2016a). *Les compétences lexicales en arabe langue étrangère/seconde : analyse d'un corpus télévisuel syrien*. Thèse de doctorat en sciences du langage préparée à l'Université Lumière Lyon 2 et soutenue publiquement le 02 juillet 2016.
- Alnassan, A. (2016b). Written and Spoken Arabic in Syria : towards the development of teaching Arabic as a foreign language at the Higher Language Institute of Damascus. In : *The 4th FLLT Conference Proceedings by LITU*, 4 (1), pp.33 – 45. The 4th FLLT Conference "Foreign Language Learning and Teaching", 24 – 25 June 2016, The Ambassador Hotel, Bangkok, Thailand.
- Alnassan, A. (2017). Didactique de l'arabe et problématique de la polyglossie : approche comparative entre l'arabe littéraire et le dialecte syrien en vue d'améliorer la qualité de l'enseignement de l'arabe, langue étrangère. In *Les Carnets du Cediscor, 13*. Presses Sorbonne Nouvelle, Paris, pages 46 – 59.
- Attia, M., Pecina, P., Toral, A., & Genabith, J. V. (2013). A corpusbased finite-state morphological toolkit for contemporary arabic. *Journal of Logic and Computation* (pp. exs070).
- Baniata, L. H., Park, S., & Park, S. B. (2018). A Neural Machine Translation Model for Arabic Dialects That Utilises Multitask Learning (MTL). In *Computational Intelligence and Neuroscience*. Retrieved October 31, 2022, from <https://www.hindawi.com/journals/cin/2018/7534712/>
- Brown, P. F., Cocke, J., Della Pietra, S. A., Della Pietra, V. J., Jelinek, F., Lafferty, J. D., Mercer, R. L., & Roossin, P. S. (1990). A statistical approach to machine translation. *Computational Linguistics*, 16(2), pages 79–85.
- Callison-Burch, C., Koehn, P., & Osborne, M. (2006). Improved statistical machine translation using paraphrases. In *Proceedings of the Human Language Technology Conference of the NAACL, Main Conference* (pp. 17–24).
- Chiang, D., Diab, M., Habash, N., Rambow, O., & Shareef, S. (2006). Parsing Arabic Dialects. In *Proceedings of the European Chapter of ACL (EACL)*. Retrieved October 31, 2022, from <https://aclanthology.org/events/eacl-2006/>
- Du, J., Jiang, J., & Way, A. (2010). Facilitating translation using source language paraphrase lattices. In *Proceedings of the 2010 Conference on Empirical Methods in Natural Language Processing, EMNLP'10* (pp. 420–429). Cambridge, Massachusetts.
- Habash, N. & Rambow, O. (2006). MAGEAD: A Morphological Analyzer and Generator for the Arabic Dialects. In *Proceedings of the 21st International Conference on Computational Linguistics and 44th Annual Meeting of the Association for Computational Linguistics* (pp. 681–688). Sydney, Australia.
- Harrat, S., Meftouh, K., & Smaili, K. (2017). Machine translation for Arabic dialects (survey). *Information Processing and Management* (56 (2), pp. 262-273). Elsevier.
- Riesa, J., & Yarowsky, D. (2006). Minimally Supervised Morphological Segmentation with Applications to Machine Translation. In *Proceedings of the 7th Conference of the Association for Machine Translation in the Americas (AMTA06)* (pp. 185–192). Cambridge, MA.

- Salloum, W. & Habash, N. (2011). Dialectal to Standard Arabic Paraphrasing to Improve Arabic-English Statistical Machine Translation. In *Proceedings of the First Workshop on Algorithms and Resources for Modelling of Dialects and Language Varieties* (pp. 10–21). Edinburgh, Scotland.
- Sawaf, H. (2010). Arabic dialect handling in hybrid machine translation. In *Proceedings of the Conference of the Association for Machine Translation in the Americas (AMTA)*, Denver, Colorado.
- Zaidan, O. F., & Callison-Burch, C. (2011). Crowdsourcing translation: Professional quality from non-professionals. In *Proceedings of the 49th Annual Meeting of the Association for Computational Linguistics: Human Language Technologies* (pp. 1220–1229). Portland, Oregon.
- Zbib, R., Malchiodi, E., Devlin, J., Stallard, D., Matsoukas, S., Schwartz, R., Makhoul, J., Zaidan†, O. F., & Callison-Burch‡, C. (2012). Machine Translation of Arabic Dialects. *Conference of the North American Chapter of the Association for Computational Linguistics: Human Language Technologies* (pp. 49–59). Montréal, Canada, June 3-8, 2012.

Appendix A Transliteration of the Arabic alphabet

Arabic letter	Symbol	Arabic letter	Symbol	Arabic letter	Symbol	Arabic letter	Symbol
ء	'	د	d	ض	ḍ	ك	k
ب	b	ذ	ḏ	ط	ṭ	ل	l
ت	t	ر	r	ظ	ẓ	م	m
ث	ṯ	ز	z	ع	'	ن	n
ج	j	س	s	غ	ġ	ه	h
ح	ḥ	ش	š	ف	f	و	w
خ	ḫ	ص	ṣ	ق	q	ي	y

Short vowels		Long vowels	
ـِ	a	ا	ā
ـُ	u	و	ū
ـِ	i	ي	ī

Appendix B Arabic-English corpora on OPUS

Search & download resources: show all versions

Language resources: click on [tmx | mooses | xces | lang-id] to download the data! (raw = untokenized, ud = parsed with universal dependencies, alg = word alignments and phrase tables)

corpus	doc's	sent's	ar tokens	en tokens	XCES/XML	raw	TMX	Moses	mono	raw	ud	alg	dic	freq	other files
CCMatrix v1	1	49.7M	805.8M	900.9M	xces ar en	ar en	tmx	mooses	ar en	ar en				ar en	sample
WikiMatrix v1	1	2.0M	79.6M	1.0G	xces ar en	ar en	tmx	mooses	ar en	ar en				ar en	sample
UNPC v1.0	114067	16.6M	394.7M	445.4M	xces ar en	ar en	tmx	mooses	ar en	ar en		alg		ar en	sample
MultiUN v1	67617	8.2M	201.7M	228.2M	xces ar en	ar en	tmx	mooses	ar en	ar en		alg		ar en	query sample
CCAligned v1	507	13.0M	188.7M	200.6M	xces ar en	ar en	tmx	mooses	ar en	ar en				ar en	sample
wikimedia v20210402	1	0.4M	24.7M	349.2M	xces ar en	ar en	tmx	mooses	ar en	ar en				ar en	sample
OpenSubtitles v2018	8256	4.6M	26.8M	29.9M	xces ar en	ar en	tmx	mooses	ar en	ar en		alg smt	dic	ar en	query sample xces/alt
XLEnt v1.1	1	5.6M	19.1M	18.7M	xces ar en	ar en	tmx	mooses	ar en	ar en				ar en	sample
QED v2.0a	5033	0.7M	6.6M	9.5M	xces ar en	ar en	tmx	mooses	ar en	ar en		alg smt	dic	ar en	sample
TED2020 v1	3879	0.4M	6.4M	8.1M	xces ar en	ar en	tmx	mooses	ar en	ar en				ar en	sample
Tanzil v1	30	0.2M	7.9M	5.6M	xces ar en	ar en	tmx	mooses	ar en	ar en		alg smt	dic	ar en	query sample
News-Commentary v16	7185	83.2k	5.0M	3.8M	xces ar en	ar en	tmx	mooses	ar en	ar en		alg smt	dic	ar en	sample
UN v20090831	1	74.1k	3.3M	3.7M	xces ar en	ar en	tmx	mooses	ar en	ar en		alg smt		ar en	query sample
Wikipedia v1.0	1	0.2M	3.2M	3.5M	xces ar en	ar en	tmx	mooses	ar en	ar en		alg smt	dic	ar en	query sample
TED2013 v1.1	1	0.2M	2.4M	3.0M	xces ar en	ar en	tmx	mooses	ar en	ar en		alg smt	dic	ar en	query sample
GNOME v1	1313	0.5M	2.4M	2.6M	xces ar en	ar en	tmx	mooses	ar en	ar en		alg smt		ar en	sample
bible-uedin v1	2	61.5k	0.9M	1.5M	xces ar en	ar en	tmx	mooses	ar en	ar en		alg smt	dic	ar en	sample
GlobalVoices v2018q4	3875	58.3k	1.0M	1.3M	xces ar en	ar en	tmx	mooses	ar en	ar en		alg smt	dic	ar en	sample
KDE4 v2	784	0.1M	0.7M	0.8M	xces ar en	ar en	tmx	mooses	ar en	ar en		alg smt	dic	ar en	query sample
Mozilla-I10n v1	1	51.7k	0.2M	0.7M	xces ar en	ar en			ar en	ar en				ar en	sample
ELRC_2922 v1	1	15.1k	0.3M	0.3M	xces ar en	ar en	tmx	mooses	ar en	ar en		alg smt	dic	ar en	sample
EUbookshop v2	30	1.7k	80.0k	0.4M	xces ar en	ar en	tmx	mooses	ar en	ar en		alg smt	dic	ar en	query sample mooses/strict
infopankki v1	290	16.0k	0.2M	0.2M	xces ar en	ar en	tmx	mooses	ar en	ar en		alg smt	dic	ar en	sample
Tatoeba v2022-03-03	1	27.3k	0.1M	0.2M	xces ar en	ar en	tmx	mooses	ar en	ar en				ar en	sample
tico-19 v2020-10-28	1	3.1k	67.9k	70.4k	xces ar en	ar en	tmx	mooses	ar en	ar en		alg smt	dic	ar en	sample
Ubuntu v14.10					xces ar en	ar en	tmx	mooses	ar en	ar en			dic	ar en	sample
total	212879	102.8M	1.8G	3.3G	102.8M	101.0M	115.6M								

color:	size (src+trg):
	16.4k 32.8k 65.5k 0.1M 0.3M 0.5M 1.0M 2.1M 4.2M 8.4M 16.8M 33.6M 67.1M 134.2M

English-Arabic corpora on OPUS

Search & download resources: show all versions

Language resources: click on [tmx | mooses | xces | lang-id] to download the data! (raw = untokenized, ud = parsed with universal dependencies, alg = word alignments and phrase tables)

corpus	doc's	sent's	ar tokens	en tokens	XCES/XML	raw	TMX	Moses	mono	raw	ud	alg	dic	freq	other files
CCMatrix v1	1	49.7M	805.8M	900.9M	xces ar en	ar en	tmx	moses	ar en	ar en			ar en		sample
WikiMatrix v1	1	2.0M	79.6M	1.0G	xces ar en	ar en	tmx	moses	ar en	ar en			ar en		sample
UNPC v1.0	114067	16.6M	394.7M	445.4M	xces ar en	ar en	tmx	moses	ar en	ar en		alg	ar en		sample
MultiUN v1	67617	8.2M	201.7M	228.2M	xces ar en	ar en	tmx	moses	ar en	ar en		alg	ar en	query	sample
CCAligned v1	507	13.0M	188.7M	200.6M	xces ar en	ar en	tmx	moses	ar en	ar en			ar en		sample
wikimedia v20210402	1	0.4M	24.7M	349.2M	xces ar en	ar en	tmx	moses	ar en	ar en			ar en		sample
OpenSubtitles v2018	8256	4.6M	26.8M	29.9M	xces ar en	ar en	tmx	moses	ar en	ar en		alg smt	dic	ar en	query sample xces/alt
XLEnt v1.1	1	5.6M	19.1M	18.7M	xces ar en	ar en	tmx	moses	ar en	ar en			ar en		sample
QED v2.0a	5033	0.7M	6.6M	9.5M	xces ar en	ar en	tmx	moses	ar en	ar en		alg smt	dic	ar en	sample
TED2020 v1	3879	0.4M	6.4M	8.1M	xces ar en	ar en	tmx	moses	ar en	ar en			ar en		sample
Tanzil v1	30	0.2M	7.9M	5.6M	xces ar en	ar en	tmx	moses	ar en	ar en		alg smt	dic	ar en	query sample
News-Commentary v16	7185	83.2k	5.0M	3.8M	xces ar en	ar en	tmx	moses	ar en	ar en		alg smt	dic	ar en	sample
UN v20090831	1	74.1k	3.3M	3.7M	xces ar en	ar en	tmx	moses	ar en	ar en		alg smt	ar en	query	sample
Wikipedia v1.0	1	0.2M	3.2M	3.5M	xces ar en	ar en	tmx	moses	ar en	ar en		alg smt	dic	ar en	query sample
TED2013 v1.1	1	0.2M	2.4M	3.0M	xces ar en	ar en	tmx	moses	ar en	ar en		alg smt	dic	ar en	query sample
GNOME v1	1313	0.5M	2.4M	2.6M	xces ar en	ar en	tmx	moses	ar en	ar en		alg smt	ar en		sample
bible-uedin v1	2	61.5k	0.9M	1.5M	xces ar en	ar en	tmx	moses	ar en	ar en		alg smt	dic	ar en	sample
GlobalVoices v2018q4	3875	58.3k	1.0M	1.3M	xces ar en	ar en	tmx	moses	ar en	ar en		alg smt	dic	ar en	sample
KDE4 v2	784	0.1M	0.7M	0.8M	xces ar en	ar en	tmx	moses	ar en	ar en		alg smt	dic	ar en	query sample
Mozilla-I10n v1	1	51.7k	0.2M	0.7M	xces ar en	ar en			ar en	ar en			ar en		sample
ELRC 2922 v1	1	15.1k	0.3M	0.3M	xces ar en	ar en	tmx	moses	ar en	ar en		alg smt	dic	ar en	sample
EUbookshop v2	30	1.7k	80.0k	0.4M	xces ar en	ar en	tmx	moses	ar en	ar en		alg smt	dic	ar en	query sample mooses/strict
infopankki v1	290	16.0k	0.2M	0.2M	xces ar en	ar en	tmx	moses	ar en	ar en		alg smt	dic	ar en	sample
Tatoeba v2022-03-03	1	27.3k	0.1M	0.2M	xces ar en	ar en	tmx	moses	ar en	ar en			ar en		sample
tico-19 v2020-10-28	1	3.1k	67.9k	70.4k	xces ar en	ar en	tmx	moses	ar en	ar en		alg smt	dic	ar en	sample
Ubuntu v14.10					xces ar en	ar en	tmx	moses	ar en	ar en			dic	ar en	sample
total	212879	102.8M	1.8G	3.3G	102.8M		101.0M	115.6M							

color:																
size (src+trg):	16.4k	32.8k	65.5k	0.1M	0.3M	0.5M	1.0M	2.1M	4.2M	8.4M	16.8M	33.6M	67.1M	134.2M		



Emotional Intelligence and Academic Achievement among Arab Secondary School Students at Some Arab School in Malaysia

Chafai Yasmine

PhD student in Educational Psychology, International Islamic University Malaysia
mimina162009@hotmail.fr

Siti Rafiah Abd. Hamid

Kulliyah of Education, International Islamic University Malaysia
srafiah60@iium.edu.my

Mohd Burhan Bin Ibrahim

Kulliyah of Education, International Islamic University Malaysia
mburhan@iium.edu.my

ABSTRACT

It is very difficult for a secondary school student to deal with the physical and emotional changes during the adolescence period and at the same time to be in line with the rapid development of the learning process. Thus, the ability to control emotions has become important to avoid any academic failure. Therefore, the main objective of this study was to examine the relationship between Emotional intelligence and academic achievement. A correlational design was employed and the data was collected via the adapted questionnaire "Emotional Intelligence Scale". 300 Arab secondary school students participated in this study through a randomized sampling method. The descriptive analysis results revealed that the Arab secondary school students had high level of Emotional intelligence. The inferential analysis result revealed a significant negative correlation between Emotional intelligence and participants' academic achievement. Further research is recommended by using different research methods regarding the phenomena of this study among the Arab students.

Keywords: *Emotional Intelligence; Academic Achievement; Arab secondary school students*

INTRODUCTION

Nowadays, Emotional intelligence has been emerged as an important phenomenon in the field of Educational Psychology. Salovey and Mayer were the first to talk about Emotional Intelligence (EI) and they determined it as "the capacity to monitor the feelings and emotions of one's own and others, to distinguish between them, and to use this to lead one's thinking and actions" (Salovey & Mayer, 1990). A person who possesses these capacities is considered to be well adjusted and emotionally skilled. In 1995, Danial Goleman wrote a book under the name of "Emotional Intelligence" and he argued that Emotional and social intelligence are more important than IQ itself. As he defined Emotional Intelligence as the ability to motivate oneself with the help of self-control, enthusiasm and persistence (Danial Goleman, 1995).

Bar-On defines emotional intelligence as "to effectively understand oneself and others, to relate well with people, and to adapt and cope with the immediate surroundings in order to deal successfully with environmental demands" (Bar-On, 1997). George and Jones defined it as "the ability to understand one's own feelings and others and control them" (George & Jones, 1999).

Many definitions of Emotional Intelligence have been addressed throughout the years and it was clear that they were divided into two parts; the first part explains Emotional

intelligence as the ability to identify and to acknowledge emotions by analyzing and controlling them, especially the emotions that are related to ourselves, which require from us to be aware of them. On the other hand, to know others' emotions and to perceive and understand their feelings in order to use effective, successful and adaptive responses that fit the situation or attitudes which may be exposed to the individual.

The second part describes Emotional intelligence as a set of personal traits, social and emotional skills that are centered on the awareness of one's own and others' feelings and to manage it well. The essence of emotional intelligence is based on the concept of high competencies about ourselves and others and to perform highly the skills that suit the situation with which the individual interacts in his or her environment.

In this current study, Emotional Intelligence refers to “the ability of an adolescent to manage his/her own and others emotions, and to cope with the difficulties in the learning process in order to have better grades”.

CONCEPTUAL FRAMEWORK OF EMOTIONAL INTELLIGENCE

The conceptual framework of this current study was developed based on the research questions, research objectives and the review of related research. In the meantime, the current author has adopted the following model “Mayer and Salovey Model of Emotional Intelligence” to explain the relationship between Emotional Intelligence and secondary school students' Academic achievement.

Most of the reviewed studies shown that a significant positive relationship existed between the independent variable “Emotional Intelligence” and the dependent variable “Academic achievement” (Praveen & Shafeeq, 2020; Jane Waithira Karimi et al., 2020; Razia, 2018; Dr Indu Bala Tehlan & Monika Dalal, 2018; Amalu, 2018; Browne, 2017, p.5; Vijaya & Vijaya, 2016; Costa & Faria, 2015, p.38). Therefore, it is believed that having high level of Emotional intelligence in each of its four aspects “Identifying Emotions, Emotional Facilitation of Thought, Understanding and Managing Emotions” including the ability to perceive and identify emotions in oneself and others, to use emotions in a more logic, creative and rational way, to understand and recognize emotions by knowing how they are revealed and to think accordingly about them and to manage emotions in one self and others as stated in the model of Mayer and Salovey; in such a case, the student has mastered all the Emotional intelligence skills that enable him/her to manage his/her own and others emotions, and to cope with the difficulties in the learning process in order to have better grades.

STATEMENT OF THE PROBLEM

Students in secondary school face a very crucial period which is adolescence, according to Gary Novak and Martha Pelaez, Adolescence is “a continued behavioral development along a pathway established in childhood” (Novak & Pelaez, 2004, chapter 14, p. 463). The adolescence period is accompanied by the behavioral changes that happened between childhood and adulthood. It has a relation with the sexual maturation, all the biological, psychological, and social changes take place during this period.

In the adolescence period, adolescent starts to develop autonomy and involves more in family decision, therefore, it is very difficult for an adolescent pupil to deal with the physical and emotional changes, the change in family lifestyle and at the same time the rapid

development of the learning process. Thus, the ability to control emotions have become important to avoid any academic failure.

However, there is still a need to further investigate the relationship between Emotional Intelligence and academic achievement most especially among Arab adolescents who studied abroad as all the reviewed research were concerned to study these two phenomena among western and Asian population.

OBJECTIVES OF THE STUDY

In this study, there are two main objectives:

- i. First, to examine the Arab secondary school students' level of Emotional Intelligence.
- ii. Second, to ascertain the relationship between emotional intelligence and the Arab secondary school students' Academic Achievement.

HYPOTHESES OF THE STUDY

The following null hypothesis (Ho) is tested at $\alpha=.05$ level of significance and it is described as the following:

Ho1: There is no significant relationship between Emotional intelligence and the Arab secondary school students' academic achievement.

REVIEW OF RELATED RESEARCH

Emotional Intelligence and Academic Achievement

Many authors conducted research about Emotional Intelligence and Academic achievement.

The findings were divided into two parts; some authors did not find any significant relationship between Emotional Intelligence and academic achievement. For instance, Raj, A. F. (2017) conducted a study in order to examine the relation between Emotional Intelligence and academic achievement among 400 Indian high school students. The quantitative research method has been used in this study together with a self-developed questionnaire. The researcher did not find any significant correlation between Emotional Intelligence and the participants' academic achievement (Raj, 2017).

On the other hand, a lot of authors found a significant relationship between Emotional Intelligence and academic achievement, for example, Jane Waithira Karimi., Dr Jacinta Aswani Kwena., and Dr Alice Anika (2020) sought to investigate the pattern of the correlation between Emotional Intelligence and academic achievement among 271 secondary school students from Kenya. The random and cluster sampling approaches have been used when selecting the samples of this study. The quantitative research method has been used together with the Emotional Intelligence Scale developed by Schutte et al (1998) to assess participants' Emotional Intelligence. The findings depicted a significant correlation between the two variables "Emotional Intelligence and Academic Achievement" (Jane Waithira Karimi et al., 2020).

Similarly, Razia, B. (2018) from India conducted a study in order to investigate the correlation between Emotional Intelligence and academic achievement among 866 high school students from grade 11. The participants were chosen by using the stratified sampling procedure. The quantitative research method has been adopted in this study.

In order to assess participants' Emotional Intelligence, Mangal and Mangal Emotional Intelligence Inventory has been utilized. The author found a significant moderate relationship between Emotional Intelligence and respondents' academic achievement (Razia, 2018).

Browne, Y (2017) from Ireland conducted a study and one of its objectives was to explore the relationship between Emotional Intelligence and academic achievement. 164 students participated in this study; 120 of them were females and 44 were males. The mixed method approach was utilized in this research. Schutte Emotional Intelligence Scale, the theories of Intelligence scale and a qualitative question were used to measure EI. The quantitative research findings showed a significant correlation between the participants' academic achievement and Emotional Intelligence (Browne, 2017, p. 5).

The current study shared the same objective and method but the criteria of the sample is different, as in the included studies the sample were either from lower secondary or upper secondary school levels and they came from the Non-Arab countries, whereas in the current study, the sample are from both school types "lower and upper Secondary schools" and they are all Arabs who migrated with their parents to Malaysia.

METHOD

The quantitative approach was used in this research in order to examine the relationship between Emotional Intelligence (EI) and academic achievement among Arab secondary school students at some Arab schools in Malaysia.

The simple random sampling technique was used to select the participants of this current study. 300 Arab secondary school students from eight Arab schools that are located in Kuala Lumpur and Selangor, Malaysia participated in this study; 171 of them were from lower secondary school while the rest (129) were from upper secondary school.

In order to assess participants' Emotional intelligence, the Emotional Intelligence Scale (EIS) developed by Schutte et al (2009) was used. However, in the current study, the researcher adapted the EIS by translating the instrument from English to Arabic version in order to provide the two versions. For the English version, the statements in the questionnaire were modified in order to be easily understood by the Arabic secondary school students and the number of statements were minimized to 32 instead of 33.

RESULT

The Arab secondary school students' level of Emotional Intelligence

The mean scores and Std. deviations of the dependent variable "Emotional Intelligence" as well as its four dimensions have been calculated for the reason of knowing the level of Emotional Intelligence among the Arab secondary school participants as mentioned in table 1 below.

Table 33. Participants' level of Emotional Intelligence

Variable/sub-construct	Mean	SD	The Level
Emotional Intelligence	3.89	.45	High
*Managing Others' Emotions	3.88	.57	High
*Managing Own Emotions	3.93	.64	High
*Perception of Emotions	3.74	.57	High
*Utilization of Emotions	4.04	.56	High

*Sub-construct

It is clear from the table 1 above that in overall the level of Emotional Intelligence and its dimensions was quite high as the mean score of the participants responses was ranging between 3.74 to 4.04 out of 5, which means that the Arab secondary school students have the necessary of Emotional Intelligence skills that enable them to deal, manage and control their own and others emotions in order to have better grades.

The relationship between Emotional Intelligence and Participants' Academic Achievement

The current analysis was gauged for the purpose of ascertaining the relationship between the Arab secondary school students' Academic Achievement and Emotional Intelligence. Pearson's product-moment correlation coefficient has been computed to assess the relationship between the two variables "Academic Achievement and Emotional Intelligence". The researcher hypothesized that there was no significant relationship between Emotional Intelligence and participants' academic achievement.

The mean of participants' academic achievement was 3.30 with a Std. deviation of .50, meanwhile Emotional Intelligence had a mean of 3.89 and Std. deviation of .45.

The results showed that a significant negative correlation existed between Emotional Intelligence and participants' academic achievement, $r = -.117$, $n = 300$, $p = .043$, thus, the null hypothesis was rejected.

As a conclusion, from the analysis of the results, the researcher found a weak significant relationship between Emotional Intelligence (EI) and Academic Achievement among Arab Secondary School Students (See Table 2).

Table 2. Relationship between Academic Achievement and EI

		Emotional Intelligence
Academic Achievement	Pearson Correlation	-.117*
	Sig. (2-tailed)	.043
	N	300

*Correlation is significant at the 0.05 level (2-tailed)

DISCUSSION

First Finding

The aim of the first research objective was to assess the Arab secondary school students' level of Emotional intelligence. The level of participants' Emotional intelligence was high as the Arab secondary school students perceived Emotional intelligence with its four sub-constructs of "Managing Own Emotions, Managing Others' Emotions, Perception of Emotions and Utilization of Emotions". The respondents had high level in all these four sub-constructs.

This result was supported by the model of Mayer and Salovey, the four dimensions of this model helps the individual to think and act in such an appropriate way. Furthermore, Mayer and Salovey have sorted the four dimensions from the lowest to the highest. Perception of Emotions was perceived as the lowest dimension in this model, high level of Perception of emotions indicated that the individuals have the capability to understand and identify emotions in themselves and others. The second dimension is Assimilating Emotions which can be seen in form of utilization of emotions. This dimension helps the individual to think in such rational, logical and creative way. This phase enables the person to enhance the decision-making, problem solving process and improves persistence regarding challenging tasks (Salovey & Mayer, 1989; 1990).

In regard to the utilization of emotions, the Arab secondary school students need it to solve problems, to think more rationally and to persist against the different challenges in the learning process.

The third phase “Understand Emotions” which includes the capacity to recognize emotions, to know how they are revealed and to think accordingly about them. Finally, the last and the highest phase is Managing Emotions in one self and in others which helps in managing our feeling successfully as it contains the most important factors “motivational, emotional and cognitive”.

Second Finding

The aim of the second research objective was about to ascertain the relationship between emotional intelligence and the Arab secondary school students’ Academic Achievement. Based on the finding, a weak negative relationship has been found between the two variables.

A diversity of authors found a significant relationship between Emotional intelligence and respondents’ academic achievement (Jane Waithira et al., 2020; Razia, 2018; Browne, 2017). In contrast, limited findings were not similar to this current research finding, for instance, the study of Raj (2017) who aimed to study the relationship between Emotional intelligence and participants’ academic achievement. Raj could not find any significant correlation between the two variables.

CONCLUSION

The quantitative research approach was used to ascertain the relationship between Emotional Intelligence and the Arab secondary school students’ academic achievement at some Arab school in Malaysia. Two research questions together with one null hypothesis were established to assess the current study’s main objectives.

The main result of this current study depicted a weak relationship between Emotional Intelligence and academic achievement among the Arab secondary school students.

Therefore, it is really necessary to conduct more studies by using different research approaches among the Arab secondary school students for the purpose of understanding the interaction of these two constructs better and to help the students to achieve high grades.

RECOMMENDATIONS

From the results derived from the current study, the researcher hereby suggests the following recommendations:

First, further studies may support the current research’s findings by employing large population from different schools and ethnicities.

Second, teaching Emotional Intelligence skills to the Arab students by organizing workshops and conferences about the importance of this phenomenon in enhancing their academic achievement.

Third, ministry of Education in the Arab countries should include Emotional Intelligence as a course to their curriculum in order for the students to learn and master all the skills related to EI.

Fourth, more research about Emotional Intelligence and Academic achievement in the Arab countries.

Fifth, more qualitative and experimental studies should be carried out in the Arab context regarding Emotional Intelligence in order to have a better understanding of this phenomenon.

REFERENCES

- Amalu, M. N. (2018). Emotional Intelligence as Predictor of Academic Performance among Secondary School Students in Makurdi Metropolis of Benue State. *International Journal of Scientific Research in Education*, 11 (1), 63-70. Retrieved on 07/09/2021 from <http://www.ij sre.com>.
- Bar-On, R. (1997). *The Emotional Quotient Inventory (EQ-i): A test of emotional intelligence*. Toronto, Ontario, Canada: Multi-Health Systems.
- Browne, Y. (2017). *Beyond IQ: The role of Grit, Mindset and Emotional Intelligence in Academic Achievement*. Higher Diploma in Psychology.
- Costa, A & Faria, L. (2015). The impact of Emotional Intelligence on academic achievement: A longitudinal study in Portuguese secondary school. *Learning and Individual Differences*, 37, 38-47.
- Goleman, D. (1995). *Emotional intelligence: Why it can matter more than I.Q.* New York: Bantam Books.
- Indu Bala Tehlan & Monika Dalal. (2018). A Study of Relationship between Emotional Intelligence and Academic Achievement of Secondary School Students. *International Journal of Advanced Research Management and Social Sciences*, 7(3), 14-24.
- Jane Waithira Karimi., Dr Jacinta Aswani Kwena., & Dr Alice Anika. (2020). Emotional Intelligence and Academic Achievement among Secondary School Students in Kilifi County, Kenya: A Correlational Study. *Journal for Research Implications & Practice*, 4(2), 32-42.
- Praveen, S., & Shafeeq, N. Y. (2020). Effect of Emotional Intelligence on Academic Achievement of Senior Secondary School Students. *International Research Journal of Human Resource and Social Sciences*, 7 (2), 165-173.
- Raj, A. F. (2017). *Relationship between Emotional Intelligence and Academic Achievement of 9 Standard Students in Tuticorin Educational District*. A dissertation submitted in partial fulfilment of the requirement for the degree of Master of Philosophy in Education.
- Razia, B. (2018). *Emotional Intelligence, Academic Stress, Socio-Economic Status and Family Environment as Determinants of Academic Achievement among Muslim and Non-Muslim Adolescents*. Thesis submitted for the award of the degree of Doctor of philosophy in Education.
- Salovey, P. & Mayer, J. D. (1990). Emotional Intelligence. *Imagination, Cognition, and Personality*, 9, 195-211.
- Vijaya, S., & Vijaya, R. (2016). A study on relationship between Emotional Intelligence on academic achievement among secondary school students. *An International, Refereed, Peer Reviewed and Indexed Quarterly Journal in Arts, Commerce, Education & Social Sciences*, 4 (4), 88-90.

Students' Perception of Online Role Play Activity in Arabic Learning During COVID-19 Pandemic

Muhamad Hilmy Abdul Wahab

Kulliyah of Education, International Islamic University Malaysia (IIUM)
hilmyserendah@gmail.com

Arifin Mamat

Kulliyah of Education, International Islamic University Malaysia (IIUM)
drarifin@iium.edu.my

ABSTRACT

This research aims to study the perception of TASL students in the Kulliyah of Education, International Islamic University Malaysia (IIUM), towards the implementation of Arabic online role play during the Covid-19 pandemic. A quantitative research design was employed in this study utilizing a survey to collect the data. The population of the respondents in this study is 190 people who are among TASL students from 2nd year 2nd semester until alumnus. Next, an online questionnaire was spread randomly to the respondents via WhatsApp, and a total of 142 responses were successfully collected. The data were analysed quantitatively using a simple descriptive statistical analysis of frequency and percentage. The result of the data showed that online role-play positively affected in the development of students' Arabic language skills and their self-qualities. Due to its challenges, the findings showed positive results among the majority of the respondents. However, the consultation method and the comfort of students' surroundings must be given attention. Based on the findings, it is advisable for Arabic language learners to do this activity as much as possible to correct and improve their performance in practicing the language and building up their characters. Last but not least, this study needs to have a further research to make the implementation of the activity easier and better in the future and, at the same time, integrate and familiarise the usage of technologies in the learning sessions.

Keywords: *role-play; Arabic learning; online activity; Covid-19 pandemic*

ABSTRAK

Kajian ini bertujuan untuk mengkaji persepsi pelajar TASL di Kulliyah Pendidikan, Universiti Islam Antarabangsa Malaysia (UIAM) terhadap pelaksanaan aktiviti main peranan dalam Bahasa Arab secara atas talian ketika pandemik Covid-19. Reka bentuk penyelidikan secara kuantitatif telah dijalankan dalam kajian ini menggunakan kaji selidik untuk mengumpul data. Bilangan responden dalam kajian ini adalah 190 orang yang terdiri daripada pelajar TASL dari tahun 2 semester kedua sehingga alumni. Seterusnya, soal selidik secara atas talian telah disebarkan secara rawak kepada responden melalui aplikasi WhatsApp, dan sebanyak 142 maklum balas berjaya dikumpulkan. Data yang terkumpul telah dianalisis secara kuantitatif menggunakan kaedah analisis statistik deskriptif mudah iaitu kekerapan dan peratusan. Hasil daripada data tersebut menunjukkan bahawa aktiviti main peranan secara atas talian memberi kesan positif dalam pembangunan kemahiran Bahasa Arab dan kualiti diri pelajar. Berdasarkan cabaran yang dihadapi, keputusan menunjukkan hasil yang positif dalam kalangan majoriti responden. Walau bagaimanapun, kaedah perundingan dan keselesaan di persekitaran pelajar perlu diberi perhatian. Berdasarkan keputusan tersebut, pelajar bahasa Arab dinasihatkan untuk melakukan aktiviti ini sebanyak mungkin untuk membetulkan dan meningkatkan prestasi mereka dalam mengamalkan bahasa dan membentuk diri mereka. Akhir sekali, kajian ini perlu mempunyai penyelidikan lanjutan untuk menjadikan pelaksanaan

aktiviti ini lebih mudah dan lebih baik pada masa akan datang dan, pada masa yang sama, mengintegrasikan dan membiasakan penggunaan teknologi dalam sesi pembelajaran.

Kata kunci: *main peranan; pembelajaran bahasa Arab; aktiviti secara atas talian; pandemik Covid-19*

INTRODUCTION

Learning a language is essential to keep communicating with others from various countries and every learner should communicate well so the message will not be misunderstood when it is delivered to other person such as in Arabic language communication. Learning the Arabic language in Malaysia is commonly known among Malaysians who would like to learn deeper about Islamic knowledge and Arabic culture. In learning a language, the learners should empower four basic skills, which are listening, speaking, reading and writing skills, as they are interrelated to each other in affecting students' performance (Husain, 2015). These skills cannot be required by only learning the facts and structures of the language but also need a lot of practice. Therefore, various activities are needed to expose the learners to practice their language skills in real situations.

One of the activities which can have a potential impact on students' improvement with these skills is by doing role-play. Erturk (2015), Razali and Ismail (2017) agreed that this activity is an example of active language learning to improve students' skills. In getting it done in language learning, the learners will have to do a lot of preparation where they have to practice their acting skills by listening to the native speaker's pronunciation and then imitating it. They have to do a lot of reading to ensure they can deliver and understand the script correctly. Then, they will have to write and note a lot of things too to ensure they can prepare an excellent performance. However, the way of preparation may be different when it comes to the new norm where previously, students could consult the lecturer and have discussions by meeting other members physically, and they could do a live performance in front of the audience in a hall. This shows the way of practice and preparation for this activity is an important aspect that needs to be considered.

In the new norm, everything needs to be done virtually where they still can discuss among themselves, but the preparation and practices will be more to the individual effort because of the movement restrictions. In addition, the readiness for the students to learn virtually is still a worrisome situation such as their home environment and the internet and technologies development in their area (Allam, Hassan, Mohideen, Ramlan, & Kamal, 2020; Annamalai, 2021). In Malaysia, it is still in progress because the internet cannot be accessed easily in all places, especially in urban areas and the exposure to technology usage is still not well-known among learners. Therefore, this study is important to know students' perceptions by doing this activity via online to improve their language learning.

Statement of the problem

New norm due to the COVID-19 pandemic has affected many aspects of human life, especially in education (Baltà-Salvador, Olmedo-Torre, Peña & Renta-Davids, 2021). There are also a lot of restrictions that need to be followed to keep their safety. Besides, it has also affected the process of empowering language skills by doing the activities during the teaching and learning where it is commonly done by face-to-face (Hoofman & Secord, 2021). Moreover, it has affected and changed the way of Arabic practices among the learners where they cannot gather physically in the classroom or hall, and everything needs to be done via online. Previously, the

role-play activities could be done in front of the audience, and the learners will perform in front of their eyes. They also will prepare a lot of things to liven their performance, and then they can meet then discuss with their teammates directly (MindTools, NA). However, everything changed when the pandemic spread in the community as the assessment of some subjects with different approaches still need to be carried out. Therefore, the researcher would like to see the relevancy and suitability of this activity to be done in the new norm and how students see this activity to improve their language skills and their self-qualities.

Research Questions

- i. How does online role-play activity perceived to be useful in improving learners' Arabic language skills?
- ii. To what extent does online role-play activity perceived to be efficient in improving their self-qualities?
- iii. What are the challenges faced by students in completing the activities smoothly?

METHODOLOGY

This study adopted the quantitative approach where it aimed to examine the students' perception of online role play activity in Arabic learning during the Covid-19 pandemic. The researcher employed a cross-sectional survey to collect the data. The type of data collected from the survey (administered online via Google Form) was ordinal data representing the students' perception of the activity. To achieve this goal, the questionnaire was spread via WhatsApp to all current TASL students and alumni who had done the activity during the pandemic before graduation. The data were collected using a set of questionnaires. The items were made by measuring the aspects highlighted in previous studies. To answer the research questions of this study, the data were analyzed using the Statistical Package for Social Sciences (SPSS) IBM version 25. For all research questions, the researcher used simple descriptive statistical analysis consisting of frequencies, percentages, means and standard deviations to interpret the collected data.

FINDINGS

The data were successfully collected from 142 respondents. Further information regarding the respondents was presented below:

Table 1 Respondents

Gender	f (%)	Year of study	f (%)
Male	31 (11.8%)	2	20 (14.1%)
Female	111 (78.2%)	3	57 (40.1%)
		4	45 (31.7%)
		Alumni	20 (14.1%)

Usefulness of Online Role-play Towards Arabic Learning Skills

This section answers the first research question of this study which is "How does online role-play activity perceived to be useful in improving learners' Arabic language skills?". In this section, the respondents were required to respond to ten items. Further results are shown in the table below:

Table 2 Usefulness of Online Role-play towards Arabic Language Skills

	Strongly Disagree	Disagree	Not Sure	Agree	Strongly Agree	Mean	SD
This activity helps me to improve my Arabic language skills	1 (0.7%)	3 (2.1%)	21 (14.8%)	68 (47.9%)	49 (34.5%)	4.13	0.792
Online Arabic role-play helps me to listen to Arabic pronunciation better	1 (0.7%)	2 (1.4%)	29 (20.4%)	62 (43.7%)	48 (33.8%)	4.08	0.812
Online Arabic role-play helps me to pronounce Arabic words and sentences better in a right way	1 (0.7%)	3 (2.1%)	28 (19.7%)	60 (42.3%)	50 (35.2%)	4.09	0.833
Online Arabic role-play activity is an opportunity to assess my performance towards Arabic language skills by my own	1 (0.7%)	3 (2.1%)	30 (21.1%)	69 (48.6%)	39 (27.5%)	4.00	0.799
Online Arabic role-play encourages me to practice Arabic dialogue based on real-life situation	2 (1.4%)	4 (2.8%)	30 (21.1%)	68 (47.9%)	38 (26.8%)	3.96	0.849
Online Arabic role-play helps me to understand Arabic sentences better by listening	1 (0.7%)	4 (2.8%)	32 (22.5%)	67 (47.2%)	38 (26.8%)	3.96	0.820
Online Arabic role-play encourages me to read and understand the contents of Arabic dialogue better	1 (0.7%)	6 (4.2%)	30 (21.1%)	60 (42.3%)	45 (31.7%)	4.00	0.875
Online Arabic role-play helps me to remember a lot of new vocabularies	3 (2.1%)	2 (1.4%)	33 (23.2%)	61 (43.0%)	43 (30.3%)	3.98	0.887
Online Arabic role-play helps me to imitate Arabic pronunciation by its native speakers	1 (0.7%)	4 (2.8%)	35 (24.6%)	50 (35.2%)	52 (36.6%)	4.04	0.890
Online Arabic role-play helps me to improve the writing according to Arabic language structures	2 (1.4%)	12 (8.5%)	43 (30.3%)	63 (44.4%)	22 (15.5%)	3.64	0.894

Note: SD = Standard Deviation

Based on the table above, more than 80% of respondents agreed that online Arabic role-play helped to improve their Arabic language skills. For listening skills, the majority of the respondents agreed that this activity helped them listen to the Arabic pronunciation (more than 75%) and understand its sentences better (more than 70%). For speaking skills, this activity helped the students to pronounce Arabic words and sentences according to the language structures (more than 76%). Furthermore, this activity encouraged them to practice Arabic

dialogue based on real-life situations (74.5%) and it helped them imitate the Arabic native speakers' pronunciation (71.8%).

For reading skills, more than 73% of the respondents also agreed that the activity encouraged them to read and understand the contents of Arabic dialogue better and also to remember a lot of vocabulary. Moreover, nearly 60% of them agreed that this activity helped improve their Arabic writing according to the structure of the language but this item was the least item agreed by the respondents in this section. However, this activity was an opportunity for the respondents to assess themselves on their language skills (more than 76%).

Generally, the table proved that this activity was useful to enhance students' language skills although it was done online. Most respondents believed this activity helped them listen to Arabic pronunciation and sentences better than understand it directly. It also helped them to practice their Arabic speaking according to real-life situations especially in pronunciation and imitation of its native speakers. They also improved their reading and writing skills, remembered the vocabulary, and followed the language structure. These results helped to answer the first research question.

Efficiency of Online Arabic Role-play towards Self-Qualities

This section answers the second research question of this study, which is "To what extent does online role-play activity perceived to be efficient in improving their self-qualities?". In this section, the respondents were required to respond to ten items. Further results are shown in the table below:

Table 3 Efficiency of Online Arabic Role-play towards Self-Qualities

Items	Strongly Disagree	Disagree	Not Sure	Agree	Strongly Agree	Mean	SD
B9-Online Arabic role-play motivates me to do a best performance in completing the task	2 (1.4%)	4 (2.8%)	26 (18.3%)	66 (46.5%)	44 (31.0%)	4.03	0.858
B10-This activity is efficient to develop my self-qualities	2 (1.4%)	2 (1.4%)	29 (20.4%)	69 (48.6%)	40 (28.2%)	4.01	0.821
B4-Online Arabic role-play encourages me to have a good teamwork with other group members	2 (1.4%)	1 (0.7%)	32 (22.5%)	57 (40.1%)	50 (35.2%)	4.07	0.856
B8-Online Arabic role-play helps me to develop my self-confidence level	2 (1.4%)	3 (2.1%)	32 (22.5%)	67 (47.2%)	38 (26.8%)	3.96	0.841
B6-Online Arabic role-play encourages me to participate more during the discussion	1 (0.7%)	5 (3.5%)	33 (23.2%)	59 (41.5%)	44 (31.0%)	3.99	0.867
B1-Online Arabic role-play encourages me to be more creative in doing preparation	1 (0.7%)	2 (1.4%)	38 (26.8%)	57 (40.1%)	44 (31.0%)	3.99	0.838
B3-Online Arabic role-play helps me to socialize with other members	1 (0.7%)	10 (7.0%)	33 (23.2%)	49 (34.5%)	49 (34.5%)	3.95	0.963

B5-I can discuss easily with my group members at any time	1 (0.7%)	10 (7.0%)	37 (26.1%)	56 (39.4%)	38 (26.8%)	3.85	0.925
B2-Online Arabic role-play enhances my high order thinking (HOT) in completing the task	1 (0.7%)	9 (6.3%)	39 (27.5%)	53 (37.3%)	40 (28.2%)	3.86	0.927
B7-Online Arabic role-play helps me to make a better decision making	3 (2.1%)	6 (4.2%)	43 (30.3%)	62 (43.7%)	28 (19.7%)	3.75	0.895

Note: SD = Standard Deviation

According to the table, more than 76% of the respondents agreed that the activity was efficient in enhancing students' self-qualities. It was proven by showing the highest percentage of agreement for this activity in motivating the students to do their best in completing the task given (more than 77%). Most of them agreed that it encouraged a good teamwork among the group members (75.4%) and their participation during the discussion (72.5%). It also helped develop their self-confidence level (72.5%) and be more creative in doing their preparation (71.1%). Unfortunately, four items showed the agreement lower than 70%. From the table, more than 60% of the respondents agreed the activity helped them in enhancing their social skills (69.0%), discussing with other group members anytime easily (66.2%), enhancing their high order thinking (HOT) (65.5%) and also making better decision (63.4%).

Generally, it could be concluded that this activity efficiently helped to enhance students' qualities. Based on the majority of the respondents, it was agreed that the activity helped the students increase their motivation and confidence level, teamwork, social and thinking skill, participation, creativity, flexibility, and decision making. Therefore, this section helped in answering the second research question.

Challenges in Completing Online Arabic Role-Play Activity

This section answers the third research question of this study which is "What are the challenges faced by students in completing the activities smoothly?". In this section, the respondents were required to respond to nine items. Further results are shown in the table below:

Table 4 Challenges in Completing Online Arabic Role-Play Activity

Items	Strongly Disagree	Disagree	Not Sure	Agree	Strongly Agree	Mean	SD
C2-I can find and refer to a lot of sources to complete the activity	1 (0.7%)	9 (6.3%)	41 (28.9%)	54 (38.0%)	37 (26.1%)	3.82	0.917
C1-I can reach the availability of Internet connection in my area	1 (0.7%)	12 (8.5%)	38 (26.8%)	56 (39.4%)	35 (24.6%)	3.79	0.937
C3-I have sufficient facilities and gadgets to complete the task	1 (0.7%)	12 (8.5%)	41 (28.9%)	54 (38.0%)	34 (23.9%)	3.76	0.937
C9-I prefer to do this activity even it is done via online	8 (5.6%)	12 (8.5%)	44 (31.0%)	54 (38.0%)	24 (16.9%)	3.52	1.050

C7-I can get a lot of feedback from my lecturer about the activity	3 (2.1%)	18 (12.7%)	43 (30.3%)	57 (40.1%)	21 (14.8%)	3.53	0.965
C8-This activity does not affect me to do excellently in completing other tasks e.g. presentations, examinations and etc.	10 (7.0%)	14 (9.9%)	44 (31.0%)	53 (37.3%)	21 (14.8%)	3.43	1.081
C4-I have a suitable and comfortable place to do the activity at my home	7 (4.9%)	20 (14.1%)	43 (30.3%)	45 (31.7%)	27 (19.0%)	3.46	1.102
C6-I can easily consult with my lecturer regarding to the task	5 (3.5%)	23 (16.2%)	44 (31.0%)	50 (35.2%)	20 (14.1%)	3.40	1.032
C5-I do not have any disturbances from my family members at home	9 (6.3%)	28 (19.7%)	45 (31.7%)	44 (31.0%)	16 (11.3%)	3.21	1.084

Note: SD = Standard Deviation

Based on the table, majority of the respondents could find and refer to many sources, and could reach the availability of Internet connection in their area to complete the activity. The percentage of these two items was the highest among other items in this section which was 64.1%. In addition, 62% of the respondents agreed that they had sufficient facilities and gadgets to complete the task. Next, 54.9% of them preferred the activity although it was done online, while 31% were unsure and the rest disagreed with it. Furthermore, most of them could get much feedback from the lecturer regarding the activity (54.9%) and it did not affect them in completing other assignments excellently (52.1%). However, only 50.7% of them had a suitable and comfortable place to do the activity at their home while 30.3% were not sure and 19% disagreed with it. The remaining two items stated that less than 50% of the respondents had consultation quickly with the lecturer regarding the activity (49.3%) and no disturbance from the family members at home (42.3%). Around 31% of them were unsure, and 19.7% and 26.1% of them disagree with both items.

Generally, the table in this section showed a lesser percentage than in previous sections. In this section, there was no problem reaching the Internet connectivity and finding sources in completing the task except for some students. Most of them also got sufficient facilities and gadgets plus they preferred to do the activity even if it is done virtually. However, the comfort and suitability of place to complete the activity is a concerned as there were also disturbances from other family members. Next, they had difficulties consulting with their lecturers but gained a lot of feedback from their lecturer about the activity. Besides, they did not face difficulties in doing well in other activities. Therefore, this section helped in answering the third research question.

DISCUSSION

Usefulness of Online Role-play towards Arabic Learning Skills

The result showed that the online activity is relevant in helping students improve their language skills and also a medium to assess their own performance. This is because this kind of activity encourages students to participate actively (Erturk, 2015). This activity enhanced students to listen to Arabic pronunciation better and, at the same time, understand Arabic sentences better. Besides, it was agreed that this activity helped to enhance speaking skills, specifically in

pronouncing Arabic words and sentences correctly, plus imitating the native speakers' pronunciation. This is also an opportunity for the students to practice Arabic speaking based on real-life situations. These results proved the evidence stated by Arham, Yasri & Arafah (2016) and Razali & Ismail (2017) in learning a language. However, the researcher still thinks that the presentation of the dialogue based on real-life situations during the role-play may be limited to be assessed by the lecturers, especially by observing the students' emotions and their body language towards the delivered dialogue.

Other than that, it can be concluded as a way to remember a lot of new vocabulary. This activity encourages reading and understanding the contents of Arabic dialogue and improving Arabic writing according to its structures. For this matter, the researcher agrees with it, but for online role-play, its effectiveness will depend on how the students deliver the dialogue in front of their screen as they may choose to memorize the dialogue or not, and then put it in front of their camera and present it as they memorize it. To overcome it, the students may act the role-play by showing their entire bodies, and this can be easier to observe students' understanding and feelings when delivering the dialogue. Therefore, this online activity is helpful in giving an impact to improve students' language skills. It is also an enhancement to what have been highlighted by Sadiku (2015) on the importance of language skills in lessons.

Efficiency of Online Arabic Role-play towards Self-Qualities

The findings showed that online Arabic role-play activities motivated students to do their best in completing the task and also helped them to develop their self-confidence level (Samsibar & Naro, 2017). In the social aspect, most of the respondents agreed that this activity helped them to socialize and discuss easily with other group members anytime. Besides, it also strengthened teamwork and increased their participation (Luca & Heal, 2006).

Furthermore, most agreed that it enhanced their creativity and high-order thinking (HOT). This matter is parallel to the idea of the Ministry of Education to improve educational learning during the 21st century among students and to integrate students-centred learning. In addition, it helped them make better decisions, especially for their group-work plan, and enhanced their critical thinking, as agreed by (Grose-Fifer, 2017). Therefore, this activity is proven to efficiently develop students' self-qualities even though the role-play was done with new platforms in a new environment, and the researcher believes that it gives effect during the discussion among group members to gain various ideas.

Challenges in Completing Online Arabic Role-Play Activity

The challenges in the study were focused on the technological, pedagogical, and social aspects (Ferri, Grifoni & Guzzo, 2020). The findings showed that majority of the students did not face any difficulties finding any sources for the activity and the availability of Internet connection can be reached in their area. Furthermore, they would prefer to do this activity even if it is done via an online platform as they also have sufficient facilities and gadgets to finish the task given. Based on the researcher's opinion, the result for the technological aspect is still not reaching the satisfaction level even though it showed the agreement from the majority of the respondents towards the technological aspect, and there is still a need to improve the technological facilities, especially the availability of Internet connection around the country if there is a goal to vary educational ways in the future.

Regarding the learning process, most of them did not feel this activity as a burden to do well in other assessments, and this may prove that they can manage their time well to be excellent in all assignments. In addition, they could get a lot of feedback from their lecturer and at the same time, it also seemed difficult for them to have consultations. For the

accommodation, they have a suitable and comfortable place to do the activity in their hometown. However, they could not avoid their family members' disturbances while completing the task. Regarding this matter, this may be different for each person as they live in different places while being in the same situation. This may depend on their social status and lifestyle when they are at home, and will also affect their time management due to their responsibilities and commitments at home.

Last but not least, technological and pedagogical aspects are satisfied among the majority of the students in doing the activity. However, the consultation method may be improved and varied so the communication between students and lecturers will not be limited, especially in getting the feedback to improve the preparation of the task. For the social aspect, the ways of implementing online role-play need to be of concern as the students need a right and comfortable place to finish the task nicely and without having problems.

RECOMMENDATIONS

Recommendation to Learners of Arabic Language

It is recommended that learners have initiative to make a lot of online role-play activities using current technologies. This activity can be done outside the classroom sessions, and it can be done anywhere as long as the Internet connection and facilities are available. It may be enough if the online role-play can be done in a short video, and is done continuously. This will open more opportunities and encourage students to practice and improve Arabic language in their daily lives with correct structures and not only waiting for tasks given from teachers to improve their own performance. This also will encourage people to study the Arabic language and change their perception towards Arabic language learning.

Recommendations for Further Research

The researcher thinks that there is a need to have continuous research regarding this study to improve the implementations of this activity and also to identify the development of technologies in this country. This activity is suitable for language learning and can be applied to other subjects and a medium for students to practice and improve their understanding of the facts and theories learnt in the classrooms for this new norm. This activity is a way of learning to gain students' interest and get all their involvement in the activity. Anyone can do it as they do not have to book certain places to do it and they can just do it by using their own gadgets. Last but not least, the study of this activity will also help determine the satisfaction and readiness of technological development in our country to advance and compete with other developing countries.

CONCLUSION

Based on what has been studied in this research, the researcher believes this activity is relevant to be done regardless of the students' situation. This may affect differently towards the experience faced by students between usual and online role-playing. However, it may be a good start for those who may be shy to confront other people directly, and it may be a first step to building up their self-esteem. This online activity proves that nothing can hinder achieving the goals of education, especially polishing the language skills among the students in any situation. However, its implementations still need to be studied as many of them still have difficulties completing the activity in the best condition. Therefore, the success of online role-play activity is not only assessed by looking at the process of its completion and the students' surroundings.

REFERENCES

- Arham, R., Yassi, A. H. & Arafah, B. (2016) The Use of Role Play to Improve Teaching Speaking, *International Journal of Scientific and Research Publications*. Retrieved from: <http://www.ijsrp.org/research-paper-0316/ijsrp-p5141.pdf>
- Allam, S.N.S., Hassan, M.S., Mohideen, R.S., Ramlan, A.F., & Kamal, R. M. (2020) Online Distance Learning Readiness During Covid-19 Outbreak Among Undergraduate Students, *International Journal of Academic Research in Business and Social Sciences*. Retrieved from: https://www.researchgate.net/publication/341820259_Online_Distance_Learning_Readiness_During_Covid-19_Outbreak_Among_Undergraduate_Students
- Annamalai, N. (2021) Online Learning during COVID-19 Pandemic. Are Malaysian High School Students Ready?, *Pernatika Journals*. Retrieved from: [http://www.pertanika.upm.edu.my/resources/files/Pertanika%20PAPERS/JSSH%20Vol.%2029%20\(3\)%20Sep.%202021/06%20JSSH-7812-2020.pdf](http://www.pertanika.upm.edu.my/resources/files/Pertanika%20PAPERS/JSSH%20Vol.%2029%20(3)%20Sep.%202021/06%20JSSH-7812-2020.pdf)
- Baltà-Salvador, R., Olmedo-Torre, N., Peña, M., & Renta-Davids, A. I. (2021). Academic and emotional effects of online learning during the COVID-19 pandemic on engineering students. *Education and information technologies*, 26(6), 7407–7434. Retrieved from: <https://doi.org/10.1007/s10639-021-10593-1>
- Collins Dictionary (2021) Definition of role play. Retrieved from: <https://www.collinsdictionary.com/dictionary/english/role-play>
- Erturk, E. (2015) Role Play as a Teaching Strategy, *ResearchGate*. Retrieved from: https://www.researchgate.net/publication/284166003_Role_Play_as_a_Teaching_Strategy
- Ferri, F., Grifoni, P. & Guzzo, T. (2020) Online Learning and Emergency Remote Teaching: Opportunities and Challenges in Emergency Situations, *Societies*. Retrieved from: https://www.researchgate.net/publication/346877581_Online_Learning_and_Emergency_Remote_Teaching_Opportunities_and_Challenges_in_Emergency_Situations
- Ghani, M. T. A. & Daud, W. A. A. W.. (2017) Exploring User Acceptance on E-learning as an Effective Medium to learn Arabic Language, *Journal of Humanities, Language, Culture and Business*. Retrieved from: https://www.researchgate.net/publication/320101529_exploring_user_acceptance_on_e-learning_as_an_effective_medium_to_learn_arabic_language
- Grose-Fifer, J. (2017). Using role-play to enhance critical thinking about ethics in Psychology. In R. Obeid, A. Schartz, C. Shane-Simpson, & P. J. Brooks (Eds.) *How We Teach Now: The GSTA Guide to Student-Centered Teaching*. Retrieved from: https://www.researchgate.net/publication/319288259_Using_Role-Play_to_Enhance_Critical_Thinking_about_Ethics_in_Psychology
- Haron, S. C., Ahmad, I. S., Mamat, A. & Ahmed, I. H. (2012) Using Media to Enhance Arabic Speaking Skills among Malay Learners, *Journal of Education & Practice*. Retrieved from: <https://core.ac.uk/download/pdf/234633538.pdf>
- Hoofman, J., & Secord, E. (2021). The Effect of COVID-19 on Education. *Pediatric clinics of North America*, 68(5), 1071–1079. Retrieved from: <https://doi.org/10.1016/j.pcl.2021.05.009>
- Husain, N. (2015) Language & Language Skills, *ResearchGate*. Retrieved from: https://www.researchgate.net/publication/274310952_Language_and_Language_Skills

- Luca, J. & Heal, D. (2006). Is Role-play an effective Teaching approach to assist Tertiary students to Improve Teamwork Skills. *ECU Publications*. 1. Retrieved from: https://www.researchgate.net/publication/49278063_Is_Role-play_an_effective_Teaching_approach_to_assist_Tertiary_students_to_Improve_Teamwork_Skills/citation/download
- Mese, E. & Sevilen, C. (2021) Factors influencing EFL students' motivation in online learning: A qualitative case study, *Journal of Educational Technology & Online Learning*. Retrieved from: <https://files.eric.ed.gov/fulltext/EJ1286748.pdf>
- MindTools. (NA) Role-Playing: Preparing for Difficult Conversations and Situations. Retrieved from: <https://www.mindtools.com/CommSkill/RolePlaying.htm>
- Nguyen, T. (2015). The effectiveness of online learning: beyond no significant difference and future horizons. *MERLOT Journal of Online Learning and Teaching*, 11(2), 1–11. Retrieved from: https://www.researchgate.net/publication/308171318_The_Effectiveness_of_Online_Learning_Beyond_No_Significant_Difference_and_Future_Horizons
- Osman, N. & Hamzah, M. I. (2017) Student Readiness in Learning Arabic Language based on Blended Learning, *International Journal of Applied Linguistics & English Literature*. Retrieved from: <https://www.journals.aiac.org.au/index.php/IJALEL/article/view/3380>
- Razali, N. N. F. M. & Ismail, R. (2017) The Use Of Simulation and Role-Play in Enhancing Speaking Skills in Learning English Language, *Journal of Education and Social Sciences*. Retrieved from: http://jesoc.com/wp-content/uploads/2017/04/KC6_45.pdf
- Sadiku, L. M. (2015) The Importance of Four Skills Reading, Speaking, Writing, Listening in a Lesson Hour, *European Journal of Language & Literature Studies*. Retrieved from: http://journals.euser.org/files/articles/ejls_jan_apr_15/Lorena_Manaj.pdf
- Samsibar & Naro, W. (2017) The Effectiveness of Role Play Method Toward Students' Motivation in English Conversation, *ETERNAL (English Teaching Learning and Research Journal)* 4(1):107-116. Retrieved from: https://www.researchgate.net/publication/326269705_the_effectiveness_of_role_play_method_toward_students%27_motivation_in_english_conversation
- Tan, C. (2020) The impact of COVID-19 on student motivation, community of inquiry and learning performance, *Asian Education and Development Studies*. Retrieved from: <https://www.emerald.com/insight/content/doi/10.1108/AEDS-05-2020-0084/full/pdf?title=the-impact-of-covid-19-on-student-motivation-community-of-inquiry-and-learning-performance>

Students' Need Analysis for i-Kalam Application in Learning Arabic Speaking Skill

Alif Fahmi Bin Abdullah
Kolej Profesional Baitulmal Kuala Lumpur
aliffahmi@kpbkl.edu.my

Taufik Bin Ismail
International Islamic University Malaysia
taufik@iium.edu.my

Muhammad Sabri Bin Sahrir
International Islamic University Malaysia
muhdsabri@iium.edu.my

Mohd Izzat Bin Mohd Abd Shukur
Kolej Profesional Baitulmal Kuala Lumpur
izzat@kpbkl.edu.my

ABSTRACT

Modern technology plays an important part in influencing the field of education today. The Arabic language is also not exempted from the use of this modern technology for the teaching and learning process. This first-phase of a study known as needs analysis aimed to identify the needs of Arabic language learners in designing the i-Kalam application for strengthening Arabic speaking skills among religious secondary school students. The Unified Theory of Acceptance and Use of Technology (UTAUT) theory was used as a basic model for the study. A survey method was utilized among 105 form one students at Al-Madrasah Ad-Diniah Al-Alawiyah Religious School at Arau, Perlis. The collected data was analyzed using descriptive statistics and the Statistical Packages for the Social Sciences (SPSS) software. The overall findings show a high need to design a mobile application for strengthening Arabic speaking skills among form one students at religious school in Malaysia.

Keywords: Needs Analysis; i-Kalam Application; Speaking Skill.

ABSTRAK

Teknologi moden memainkan peranan yang penting dalam mempengaruhi bidang pendidikan pada hari ini. Bahasa Arab juga tidak terkecuali dalam penggunaan teknologi moden di dalam proses pengajaran dan pembelajaran. Fasa pertama kajian iaitu fasa analisis keperluan bertujuan untuk mengenalpasti keperluan membangunkan aplikasi i-Kalam bagi meningkatkan kemahiran bertutur bahasa Arab dalam kalangan pelajar sekolah menengah agama. Teori Penerimaan dan Penggunaan Teknologi (UTAUT) telah digunakan bagi mendasari kajian ini. Kaedah tinjauan digunakan melalui edaran borang soal selidik kepada 105 pelajar tingkatan satu di Sekolah Al-Madrasah Ad-Diniah-Al-Alawiyah, Arau, Perlis. Data yang diperoleh dianalisis secara statistik diskriptif menggunakan perisian SPSS. Dapatan kajian secara keseluruhan menunjukkan wujud keperluan untuk membangunkan aplikasi i-Kalam bagi meningkatkan kemahiran bertutur bahasa Arab dalam kalangan pelajar tingkatan satu di sekolah menengah agama di Malaysia.

Kata Kunci: Analisis Keperluan; Aplikasi i-Kalam; Kemahiran Bertutur.

أصبحت التكنولوجيا جزءًا أساسيًا من حياة الناس في عصرنا هذا، إذ أصبح الناس يستخدمون التكنولوجيا في شتى مناحي الحياة، خاصة في مجال التعليم والتعلم. إن التطور السريع في تكنولوجيا المعلومات والاتصالات أثر بشكل كبير في مجال التعليم والتعلم. ويتجلى الوعي بهذه الأهمية من خلال بيان وزارة التعليم الماليزية في الخطة التعليم (2013 – 2025) التي حددت في التحول السابع: "تطوير تكنولوجيا المعلومات والاتصالات لتوسيع نطاق جودة التعلم في ماليزيا" (وزارة التعليم الماليزية، 2013). وهذا يبين مدى اهتمام الوزارة بهذا الجانب.

وقد شاع في العالم اليوم استخدام الهواتف الذكية بمختلف أنواعها ومميزاتها في كل أنحاء العالم وفي شتى المجالات من بينها في مجال التعليم، وظهر مفهوم التعلم بالمحمول في بداية القرن الحادي والعشرين في الدول الغربية، ويعتبر هذا المصطلح مصطلحًا جديدًا في مجال التعليم حيث أطلقت عليه عدة مستميات باللغة الإنجليزية Mobile Learning، أو m-Learning، أو mLearning (الدهشان، 2010). يشير التعلم بالمحمول أساسًا إلى التعلم باستخدام الأجهزة المحمولة مثل الهواتف المحمولة والهواتف الذكية والمساعدات الرقمية الشخصية (PDAs) (محمد رضوان وسعيدة سيراج، 2010)، وهو يقدم الحل المثالي ويجعل عملية التعلم فعالة (القديمي، 2013). فاستخدام الهواتف الذكية في عملية التعليم والتعلم يعد أحدث الوسائل التعليمية في عصرنا الحالي خصوصًا لتعلم مهارة الكلام.

مهارة الكلام من أهم الجوانب في إتقان اللغة العربية (وان أزورا وآخرون، 2007)، كما أنها تأخذ نصيبًا وافرًا في برامج تعليم اللغة لغير الناطقين بها، وذلك لأن الهدف الاتصالي هو الهدف الأقوى عند أغلب متعلمي اللغات (الفوزان، 2011). لقد توصل الباحثون من خلال دراساتهم إلى وجود أسباب كثيرة تؤدي إلى ضعف مهارة الكلام لدى المتعلمين منها قلة مفردات اللغة العربية (عبد الرحمن عبد الله، 2009)، وضعف ثقة الطالب بنفسه لممارسة الكلام باللغة العربية (غزالي يسري وآخرون، 2010)، وقلة ممارسة اللغة العربية داخل الفصل وخارجه (زاتي أزمينا، 2014)، والخوف من الخطأ حتى لا يكون ذلك مجالًا للضحك والسخرية من طرف الأصدقاء (أشينيديا، 2012)، ومسألة التراكيب والأنظمة اللغوية والبيئة غير المشجعة (ندوة ونديلة، 2014)، وعدم توفير بيئة مناسبة لممارسة اللغة العربية (محمد بخير، 2011)، وعدم وجود البرامج أو الأنشطة اللغوية الخاصة بالمتعلمين (محمد بخير، 2011) وغيرها. ولخصت نور نبيلة ورضوى أبو بكر (2019) ضعف مستوى مهارة الكلام لدى الطلبة بعوامل داخلية، وأخرى خارجية، وأخرى لغوية.

وعلى صعيد آخر، كشف محمد نجيب جعفر وآخرون (2018) أن الطلاب في المرحلة المدرسية الثانوية يواجهون صعوبة لممارسة الكلام باللغة العربية في المدرسة وفي المنزل. كما أبرز محمد بخير (2011) أن معظم المتعلمين الماليزيين يواجهون مشاكل مستمرة عندما أرادوا أن يمارسوا اللغة العربية في التعامل اليومي مع الآخرين. وقد كشفت نور وينا رشيد وزواوي إسماعيل (2019) أيضًا في دراستهما أن الطلاب في المدرسة الثانوية الدينية يعانون من قلق الكلام عند مواجهة الاختبار الشفهي باللغة العربية. وعلاوة على ذلك، وجدت نور فائزة بنت محمد حميد (2019) في دراستها عن التحديات في تعليم وتعلم اللغة العربية في المدرسة الثانوية أن الطلبة لا يجدون فرص واسعة لممارسة اللغة العربية أثناء تعلم هذه اللغة.

من هنا، يرى الباحث أن استخدام التكنولوجيا - الهواتف الذكية - من إحدى الوسائل التعليمية الحديثة التي لا ينبغي تجاهلها لاكتساب مهارة الكلام. والهواتف الذكية بدورها جزء من الوسيلة الحديثة التي تؤدي دورًا مهمًا في مساعدة الطلاب أثناء تعلم اللغة، وتعتبر من الأجهزة التعليمية الفعالة لتعلم اللغة كما أشارت إلى ذلك دراسة شهيدا ناز وآخرون (2019). وأثبتت فوزية عبد الله آل علي في دراستها أن استخدام الأجهزة المحمولة سيطور المهارات الاتصالية لدى الطلبة، وزادت أن التدريس باستخدام الأجهزة المحمولة له أهمية قصوى للطلبة (2019).

تحليل الحاجات

عرّف McArdle (1998) تحليل الحاجات بأنه عملية إجراء النشاط لمعرفة مشاكل أو قضية معينة موجودة في بيئة العمل، ويستطيع تحديد إما القيام بإصلاحها ضروري أو بالعكس. كما عرّف ويتكين (Witkin) (1997) تحليل الحاجات بأنه طريقة تستخدم لتحديد الفجوات بين الظروف الحالية والظروف المستهدفة. من هنا، يمكن أن نفهم أن تحليل الحاجات يعني الإجابة على الأسئلة: ما هو الوضع الحالي للبيئة المعنية، وما هو الوضع الذي تريد أن تصل إليه هذه البيئة؟ لذا، تهدف هذه الدراسة إلى معرفة حاجات المتعلمين نحو استخدام تطبيق الهاتف الذكي لتعلم مهارة الكلام باللغة العربية.

منهجية البحث

استخدم الباحث في هذه الدراسة طريقة المسح باستخدام الاستبانة للحصول على البيانات حول حاجات المستخدمين لتصميم تطبيق "أي-كلام" عبر الهواتف الذكية. واستفاد الباحث في تصميم بنود الاستبانة من دراسة محمد فaries صالح وسعيدة سبراج (2016) ودراسة عبد الرحمن بن سفيان وآخرون (2020). وتتبع الإجابة عن فقرات الاستبانة بدرجات تتراوح من 1-5 والتي تمثل الدرجات المعايير الآتية: (غير موافق جدًا - غير موافق - موافق إلى حد ما - موافق - موافق جدًا). وقد تم توزيع استبانة تحليل الحاجات على أفراد عينة الدراسة من الطلبة الذين يدرسون مادة اللغة العربية المعاصرة في المعهد الدينية العلوية في منطقة أراو بولاية برليس يوم 26 يوليو 2022 لجمع البيانات، وعددهم الإجمالي 105 طالبًا وطالبة. ذكر سمر محمد حسين (2006) أن الاستبانة إحدى الأساليب الأساسية التي تستخدم في جميع بيانات أولية أو أساسية أو مباشرة من العينة المختارة أو من جميع مفردات مجتمع البحث عن طريق توجيه الأسئلة المحددة المعدة مقدمًا.

ومن أجل تفسير المتوسطات الحسابية للاستبانة، فقد استخدم الباحث تقادير المتوسطات الحسابية المأخوذة من دراسة

Tschannen-Moran dan Garies (2004)، وهي كما الموضح في الجدول الآتي:

جدول 1. تقادير المتوسطات الحسابية حسب تشنان-موران وجاريس

التقدير	المتوسط الحسابي
مرتفع جدا	5.00 – 4.21
مرتفع	3.41 – 4.20
معتدل	2.61 – 3.40
منخفض	1.81 – 2.60

منخفض جدا	1.00 – 1.80
-----------	-------------

نتائج البحث

وفي ما يلي نتائج الاستبانة:

أ. البيانات الديموغرافية

تتكوّن نتائج البيانات الديموغرافية من الجنس ومستوى مهارة تكنولوجيا المعلومات والاتصالات. ولننظر في الجدول كما يلي:

جدول 2. بيانات ديموغرافية الطلبة

النسبة المئوية (%)	العدد	الجنس
54.3	57	ذكر
45.7	48	أنثى
مستوى مهارة التكنولوجيا		
7.6	8	ماهر جدا
25.7	27	ماهر
45.8	48	متوسط
20	21	أقل ماهر
1	1	غير ماهر

يدلّ الجدول 2 على أن عدد الطلاب أكثر من الطالبات إذ بلغ عددهم 57 طالبا (54.3%) مقارنة بالطالبات اللاتي بلغ عددهن 48 طالبة، بالنسبة المئوية 45.7%. ويتضح من الجدول أيضاً أن أغلبية عينة الدراسة لها مستوى متوسط في مهارة استخدام تكنولوجيا المعلومات والاتصالات بمقدار 45.7%، وتليها في مستوى ماهر بمقدار 25.7%، ثم في مستوى أقل ماهر بمقدار 20%. وأشارت النتائج أيضا إلى أن 7.6% من الطلبة في مستوى ماهر جدا وواحد منهم في مستوى غير ماهر بمقدار 1%.

جدول 3. استخدام الأجهزة المحمولة

النسبة المئوية (%)	العدد	ملكية الأجهزة المحمولة
96.2	101	نعم
3.8	4	لا
أنواع الجهاز المحمولة		
52.6	92	الهاتف الذكي

1.7	3	المساعدات الرقمية الشخصية
13.1	23	الحاسبات الشخصية الصغيرة
6.3	11	الهاتف المحمول
1.7	3	نيت بوك
24.6	43	الحاسوب المحمول
مستوى القدرة الوظيفية للجهاز المحمول		
0	0	المستوى الأول
16.8	17	المستوى الثاني
83.2	84	المستوى الثالث
قدرة اتصال بيانات الهاتف		
0	0	GPRS
0	0	HSDPA
52.9	72	الجيل الرابع اللاسلكي (4G)
49.1	64	خدمة الشبكات اللاسلكية
أسباب استخدام الأجهزة المحمولة		
21.7	68	التربية
25.5	80	الاجتماعي
27.1	85	البحث عن المعلومات والبيانات
25.5	80	الترفيهية
0.3	1	أسباب أخرى

يتضح لنا من خلال هذا الجدول أن أغلبية الطلبة لديهم الأجهزة المحمولة وتصل نسبتهم إلى 96.2%، بينما تصل نسبة الطلبة الذين لا يمتلكون الأجهزة المحمولة إلى 3.8% فقط من بين هؤلاء الطلبة. وبالنسبة لأنواع الأجهزة المحمولة التي يمتلكها الطلبة، أشارت النتائج من الجدول أعلاه إلى أن 52.6% من الطلبة لديهم الهاتف الذكي، و 24.6% منهم يمتلكون الحاسوب المحمول، وتبع ذلك الحاسبات الشخصية الصغيرة بنسبة مئوية 13.1%، ثم الهاتف المحمول بنسبة مئوية 6.3%. ونلاحظ من النتائج أيضا أن هناك الطلبة لديهم جهاز المساعدات الرقمية الشخصية و نيت بوك، وكلامها بنسبة مئوية 1.7%. من هنا، أبدى لنا أن أغلبية الطلبة لديهم الهاتف الذكي.

ويدلّ الجدول أعلاه أيضا على أن الجهاز المحمول لمعظم الطلبة في المستوى الثالث بنسبة مئوية 83.2%. كما أشارت النتائج إلى أن 16.8% من الطلبة لديهم الأجهزة المحمولة في المستوى الثاني. والجدير بالذكر أن المستوى الثالث والثاني هو مستوى مطلوب وملائم لاستخدام تطبيق أي-كلام. كما أشارت النتائج إلى أن غالبية الطلبة بنسبة مئوية 52.9% يستخدمون الجيل الرابع اللاسلكي، و 49.1% منهم يستخدمون خدمة الشبكات اللاسلكية كقدرة اتصال بيانات الهاتف. ومن الملحوظ أيضا أن لا أحد من الطلبة يستخدمون GPRS و HSDPA كقدرة اتصال بيانات الهاتف.

وفيما يتعلق بأسباب استخدام الأجهزة المحمولة لدى الطلبة، لو تأملنا الجدول السابق، لوجدنا أن النسبة الكبرى لأسباب استخدام الأجهزة المحمولة هو لبحث عن المعلومات والبيانات، وقد وصلت نسبتهم إلى 27.1%، كما لاحظ الباحث أن النسبة المعوية لسبب الاجتماعي والترفيهية متشابهتان بحيث حصلنا كل واحدة على بنسبة مئوية 25.5%. وأما الذين يستخدمون الأجهزة المحمولة من أجل الترفيه بلغت نسبتهم 21.7%. وأما الذين لهم أسباب أخرى غير الذي ذكرت سابقا بلغت نسبتهم 0.3% فقط.

جدول 4. الأداء المتوقع

التقدير	المتوسط الحسابي	الأسئلة
مرتفع جدا	4.26	تطبيق الهاتف الذكي مفيد لتعلم مهارة الكلام باللغة العربية.
مرتفع	3.86	استخدام تطبيق الهاتف الذكي أثناء تعلم اللغة العربية يمكن زيادة إنتاجيتي.
مرتفع	4.05	استخدام تطبيق الهاتف الذكي يساعدي لإكمال الواجبات بسرعة.
مرتفع	4.00	استخدام تطبيق الهاتف الذكي قادر على زيادة فرص لممارسة الكلام باللغة العربية.

يبين الجدول 4 النتائج المتعلقة باتجاهات الطلبة حول الأداء المتوقع، فقد احتل البند "تطبيق الهاتف الذكي مفيد لتعلم مهارة الكلام باللغة العربية" المتوسط الحسابي الأعلى حيث بلغ 4.26 بتقدير مرتفع جدا، تلاه البند "استخدام تطبيق الهاتف الذكي يساعدي لإكمال الواجبات بسرعة" بمتوسط حسابي بلغ 4.05 بتقدير مرتفع، كما سجل البند "استخدام تطبيق الهاتف الذكي قادر على زيادة فرص لممارسة الكلام باللغة العربية" متوسط حسابي 4.00 بتقدير مرتفع، فيما جاء البند "استخدام تطبيق الهاتف الذكي أثناء تعلم اللغة العربية يمكن زيادة إنتاجيتي" المتوسط الحسابي الأقل حيث بلغ 3.86 بتقدير مرتفع أيضا. من خلال هذه النتائج، أدرك الباحث أن أغلبية الطلبة يوافقون أن تطبيق الهاتف الذكي مفيد لتعلم مهارة الكلام باللغة العربية، كما أن أغليتهم يوافقون أن استخدام تطبيق الهاتف الذكي يساعدهم في إكمال الواجبات بسرعة، وقادر على زيادة فرص لممارسة الكلام باللغة العربية وإنتاجيتهم.

جدول 5. الجهد المتوقع

التقدير	المتوسط الحسابي	الأسئلة
مرتفع	3.85	يكون التفاعل عبر تطبيق الهاتف الذكي سهلا للفهم.
مرتفع	4.01	أنا أجد بسرعة في استخدام تطبيق الهاتف الذكي.
مرتفع جدا	4.59	تطبيق الهاتف الذكي سهل للاستخدام.

من الجدول 5 أعلاه، يتضح لنا أن البند "تطبيق الهاتف الذكي سهل للاستخدام" سجل أعلى المتوسط الحسابي وهو 4.59 بتقدير مرتفع جدا، تلاه البند "أنا أجد بسرعة في استخدام تطبيق الهاتف الذكي" بمتوسط حسابي بلغ 4.01 بتقدير

مرتفع، وفيما جاء البند "يكون التفاعل عبر تطبيق الهاتف الذكي سهلا للفهم" المتوسط الحسابي الأقل حيث بلغ 3.85 بتقدير مرتفع أيضا. وهذه النتائج تشير إلى أن أغلبية الطلبة يعتقدون أن تطبيق الهاتف الذكي سهل للاستخدام، كما أنهم يعتقدون أنهم يجيدون بسرعة في استخدام تطبيق الهاتف الذكي.

جدول 6. سلوك المستخدمين

التقدير	المتوسط الحسابي	الأسئلة
مرتفع	3.82	أحب أن أتعلم باستخدام تطبيق الهاتف الذكي.
مرتفع	3.92	استخدام تطبيق الهاتف الذكي أثناء التعليم يجعل العملية التعليمية أكثر جاذبة.
مرتفع	3.80	أنا دائما متفائل في استخدام تطبيق الهاتف الذكي أثناء تعلم اللغة العربية.
مرتفع	3.83	أنا أستمتع جداً لتعلم اللغة العربية باستخدام الهاتف الذكي.

أشارت النتائج في الجدول 6 إلى سلوك الطلبة نحو استخدام الهاتف الذكي لتعلم مهارة الكلام باللغة العربية. إذا نظرنا إلى الجدول، يتضح لنا أن كل نقطة قد حصلت على درجة "مرتفع" بالمتوسط الحسابي ما بين 3.80 – 3.92. لقد احتل البند "استخدام تطبيق الهاتف الذكي أثناء التعليم يجعل العملية التعليمية أكثر جاذبة" المتوسط الحسابي الأعلى حيث بلغ 3.92، تلاه البند "أنا أستمتع جداً لتعلم اللغة العربية باستخدام الهاتف الذكي" بمتوسط حسابي 3.83، ثم تلاه البند "أحب أن أتعلم باستخدام تطبيق الهاتف الذكي" بمتوسط حسابي 3.82، كما سجل البند "أنا دائماً متفائل في استخدام تطبيق الهاتف الذكي أثناء تعلم اللغة العربية" المتوسط الحسابي الأقل حيث بلغ 3.80. وبناءً على تقادير البنود التي تم حصولها، أن أغلبية الطلبة لديهم سلوك إيجابية نحو استخدام تطبيق أي-كلام لتعلم مهارة الكلام باللغة العربية.

جدول 7. التأثير الاجتماعي

التقدير	المتوسط الحسابي	الأسئلة
مرتفع	3.83	يمكن للأشخاص المهمين بالنسبة لي التأثير عليّ لاستخدام تطبيق الهواتف الذكية.
مرتفع	3.62	يمكن للأشخاص الذين يؤثرون في سلوكي التأثير عليّ لاستخدام تطبيق الهواتف الذكية أثناء تعلم اللغة العربية.
مرتفع	3.70	المعلم يحثني على الاستخدام تطبيق الهاتف الذكي أثناء تعلم اللغة العربية
مرتفع	3.70	تدعم مدرستي على استخدام تطبيق الهاتف الذكي في عملية التعليم والتعلم.

من الجدول السابق، يتضح لنا جلياً أن معظم الطلبة يوافقون أن يمكن للأشخاص المهمين بالنسبة لهم التأثير عليهم لاستخدام تطبيقات الهواتف الذكية حيث إن المتوسط الحسابي بلغ 3.83 بتقدير مرتفع. وأشارت النتائج أيضا إلى أن هناك البنودان سجلا المتوسط الحسابي 3.70 بتقدير مرتفع وهما البند "المعلم يحثني على الاستخدام تطبيق الهاتف الذكي أثناء تعلم اللغة العربية"

والبنء " ءءعم مءرسة على اسءءءام ءءببء الءاف الءكف فف عملفة ءءببم وءءلم". من هنا، وءء الباءء أن معظم الءلءة فوفقون أن المعلم والمءرسة فؤءراهم فف اسءءءام ءءببء الءاف الءكف أثناء ءعلم مهارة الكلام باللغة العربفة. كما ءءل ءءاءء على أن البنء "فمكن للأشءاء الءفن فؤءرون فف سلوكف ءءاءفر على لاسءءءام ءءببء الءاف الءكفة أثناء ءعلم اللغة العربفة" ءصل على أقل المءوسط الءسابف هو 3.62 بءءفر مرءفع.

ءءول 8. العوامل المفسرة

ءءفر	المءوسط الءسابف	الأسءلة
مرءفع	3.98	لءف الأءواء اللازمة لاسءءءام ءءببء الءاف الءكف.
مرءفع	3.84	لءف المعلومات عن اسءءءام ءءببء الءاف الءكف.
مرءفع	3.90	لءف شءص مءءء أشفر فله للءعب على الصعوباء أثناء اسءءءام ءءببء الءاف الءكف.

فشفر الءءول 8 إلى ءءاءء المءءلقة باءءاهاء الءلءة ءول العوامل المفسرة، فقء اءءل البنء "لءف الأءواء اللازمة لاسءءءام ءءببء الءاف الءكف" المءوسط الءسابف الأعلى ءفء بلع 3.98 بءءفر مرءفع، ءلاه البنء "لءف شءص مءءء أشفر فله للءعب على الصعوباء أثناء اسءءءام ءءببء الءاف الءكف" بمءوسط ءسابف 3.90 بءءفر مرءفع ففءا، ففما ءاء البنء "لءف المعلومات عن اسءءءام ءءببء الءاف الءكف" المءوسط الءسابف الأقل ءفء بلع 3.84 بءءفر مرءفع ففءا. وبناء على هءة البفباء، فسءءلص الباءء أن معظم الءلءة لءفهم الأءواء اللازمة والمعلومات عن اسءءءام ءءببء الءاف الءكف، كما أن لءفهم شءص مءءء لفشفر فله للءعب على الصعوباء أثناء اسءءءام ءءببء الءاف الءكف.

ءءول 9. الكفاءة الءاففة

ءءفر	المءوسط الءسابف	الأسءلة
مرءفع	3.92	أمءكن من إءمال المهام ءف قءمها المعلم بنفسف عنء اسءءءام ءءببء الءاف الءكف.
مرءفع	3.98	سأءلب المساعدة من المعلم أو الصءفء عنءما أواجه المءاكل أثناء اسءءءام ءءببء الءاف الءكف.
مرءفع	4.11	سأءمل الواءباء باسءءءام ءءببء الءاف الءكف.

فففء لنا من ءلال الءءول 9 إلى كفاءة ذاففة الءلءة فءو اسءءءام ءءببء الءاف الءكف فف ءعلم مهارة الكلام باللغة العربفة. إذا نظرنا إلى الءءول، ففءص لنا أن كل نقءة قء ءصلء على ءرءة "مرءفع" بالمءوسط الءسابف ما بفن 3.92 – 4.11. فقء اءءل البنء "سأءمل الواءباء باسءءءام ءءببء الءاف الءكف" المءوسط الءسابف الأعلى ءفء بلع 4.11 أف أن معظم الءلءة فرون أنهم سفءملون الواءباء باسءءءام ءءببء الءاف الءكف، ءلاه البنء "سأءلب المساعدة من المعلم أو الصءفء عنءما أواجه المءاكل أثناء اسءءءام ءءببء الءاف الءكف" بمءوسط ءسابف 3.98 أف أن معظم الءلءة سفءلبون المساعدة من المعلم أو الصءفء عنءما فواجهون المءاكل أثناء اسءءءام ءءببء الءاف الءكف، ففما ءاء البنء "أمءكن من إءمال المهام ءف قءمها

المعلم بنفسه عند استخدام تطبيق الهاتف الذكي " المتوسط الحسابي الأقل حيث بلغ 3.92 أي أن أغلبية الطلبة يرون أنهم يستطيعون إكمال المهام التي قَدّمها المعلم بوحده باستخدام تطبيق الهاتف الذكي.

جدول 10. نية الاستخدام

التقدير	المتوسط الحسابي	الأسئلة
مرتفع	3.97	أخطط لاستخدام تطبيق الهاتف الذكي لتنمية مهارة الكلام باللغة العربية.
مرتفع	3.98	أنوي لاستخدام تطبيق الهاتف الذكي في أسرع وقت ممكن.
مرتفع	4.00	أريد استخدام تطبيق الهاتف الذكي لزيادة المهارة في كل وقت.

يظهر من الجدول 10 النتائج المتعلقة بنية الاستخدام تطبيق الهاتف الذكي لتعلّم مهارة الكلام باللغة العربية، فقد احتل البند "أريد استخدام تطبيق الهاتف الذكي لزيادة المهارة في كل وقت" المتوسط الحسابي الأعلى حيث بلغ 4.00، تلاه البند "أنوي استخدام تطبيق الهاتف الذكي في أسرع وقت ممكن" بمتوسط حسابي بلغ 3.98، فيما جاء بند "أخطط لاستخدام تطبيق الهاتف الذكي لتنمية مهارة الكلام باللغة العربية" المتوسط الحسابي الأقل حيث بلغ 3.97. واتّضح لنا أن كل نقطة في الجدول قد حصلت على تقدير مرتفع. ولأن كل نقطة حصلت على تقدير مرتفع، وهذا التقدير يشير إلى أن الطلبة لديهم نية إيجابية لاستخدام تطبيق أي-كلام لتعلّم مهارة الكلام باللغة العربية.

جدول 11. القلق

التقدير	المتوسط الحسابي	الأسئلة
معتدل	2.67	أقلق لاستخدام تطبيق الهاتف الذكي لتعلّم مهارة الكلام باللغة العربية.
معتدل	3.38	أقلق بشأن فقدان معلومات إذا أخطأت في ضغط مفتاح في تطبيق الهاتف الذكي.
معتدل	2.72	استخدام تطبيق الهاتف الذكي قلق شديد.

دلت النتائج في الجدول 11 على مدى قلق الطلبة أثناء استخدام تطبيق الهاتف الذكي. يتّضح لنا أن كل نقطة قد حصلت على درجة "معتدل" بالمتوسط الحسابي ما بين 2.67 – 3.38. فقد لوحظ من هذه النتائج أن الطلبة يشعرون بالقلق بشأن فقدان معلومات إذا يخطؤون في ضغط مفتاح في تطبيق الهاتف الذكي حيث سجّل المتوسط الحسابي لهذا البند 3.38 باعتباره أعلى المتوسط الحسابي لهذا البند، تلاه البند "استخدام تطبيق الهاتف الذكي قلق شديد" بمتوسط حسابي بلغ 2.72، فيما جاء البند "أقلق لاستخدام تطبيق الهاتف الذكي لتعلّم مهارة الكلام باللغة العربية" المتوسط الحسابي الأقل حيث بلغ 2.67. ونفهم من هذه النتائج أن مستوى قلق الطلبة لاستخدام تطبيق أي-كلام معتدل.

إن الهدف في إجراء هذه الدراسة لمعرفة حاجات الطلبة نحو تصميم تطبيق أي-كلام عبر الهاتف الذكي لتعلم مهارة الكلام باللغة العربية. لقد أظهرت النتائج أن جميع المحاور سجلت المتوسط الحسابي بتقدير مرتفع ما عدا المحور المتعلق بالقلق حيث أنه سجل المتوسط الحسابي بتقدير معتدل. وبشكل عام، أدرك الباحث أن ثمة اتجاهات إيجابية ورغبات مذهلة لدى الطلبة نحو تصميم تطبيق أي-كلام لتعلم مهارة الكلام باللغة العربية. تنفيذ نتائج هذه الدراسة لمرحلة تصميم وتطوير التطبيق.

المصادر والمراجع

- حذيفة مازن عبد المجيد ومزهر شعبان العاني. (2015). *التعليم الإلكتروني التفاعلي*. عمان: مركز الكتاب الأكاديمي.
- الدهشان، جمال علي خليل. (2010). *استخدام الهاتف المحمول في التعليم والتدريب: لماذا؟ وفي ماذا؟ وكيف؟* مشاركة مقدمة إلى الندوة الأولى في تطبيقات تقنية المعلومات والاتصال في التعليم والتدريب. كلية التربية قسم تقنيات التعليم، جامعة الملك سعود.
- سمير محمد حسين. (2006). *دراسات في مناهج البحث العلمي، بحوث الإعلام*. القاهرة: عالم الكتب.
- عبد الرحمن بن إبراهيم الفوزان. (2011). *إضاءات لمعلمي اللغة العربية لغير الناطقين بها*. الرياض: فهرسة مكتبة الملك فهد الوطنية أثناء النشر.
- فوزية عبد الله آل علي. (2019). *تصورات واستخدامات طلبة الجامعات الإماراتية إزاء توظيف الأجهزة المحمولة في العملية التعليمية*. مجلة جامعة الشارقة للعلوم الإنسانية والاجتماعية، المجلد 14، العدد 2.
- محمد بخير حاج عبد الله. (2011). *الضعف اللغوي لدى متعلمي اللغة العربية بجامعة الإنسانية: أسبابه وعلاجه*. مجلة الدراسات اللغوية والأدبية، الجامعة الإسلامية العالمية ماليزيا، العدد 2، رقم 2LING، 268-285.
- محمد بخير الحاج عبد الله. (2011). *أثر شخصية الدارس الماليزي على اكتساب مهارة الكلام في اللغة العربية*. في عاصم سحادة علي وآخرون، *تعليم اللغة العربية للناطقين بغيرها واتجاهاتها* (ص. 237-258). ماليزيا: الجامعة الإسلامية العالمية بماليزيا.
- نور نبيلة حناني ورضوى أبو بكر. (2019). *مشكلات مهارة الكلام بالعربية لدى الناطقين بغيرها في ماليزيا استعراض منهجي للدراسات السابقة*. مجلة سلطان علاء الدين سليمان شاه. الرقم 6، العدد 2.
- Abdul Rahman Abdullah. (2009). *Kompetensi Komunikatif Dan Strategi Komunikasi Bahasa Arab Di Kalangan Pelajar Sekolah Menengah Kebangsaan Agama Di Negeri Selangor*. (Tesis Doktor Falsafah Tidak Diterbitkan). Universiti Malaya.
- Abdul Rahman Bin Sufian et. al. (2020). *Pembangunan dan Penilaian Modul Interaktif Realiti Maya Komponen Apresiasi Muzik Sekolah Menengah (e-MARZ): Satu Analisis Keperluan*. *Journal of Educational Research & Indigenous Studies*, Vol 2 (1).
- Al-Qudaimi, K. (2013). *Mobile Assisted Language Learning: A Literature Review*. English Language Department, Imam Muhammad Ibn Saud Islamic University.
- Ashinida Aladdin. (2012). *Analisis Penggunaan Strategi Komunikasi dalam Komunikasi Lisan Bahasa Arab*. *GEMA Online® Journal of Language Studies*, 12(2), 645-666.

- Ghazali Yusri, Nik Mohd. Rahimi & Parilah M. Shah. (2010). Sikap Pelajar Terhadap Pembelajaran Kemahiran Lisan Bahasa Arab di Universiti Teknologi MARA (UiTM). *GEMA Online® Journal of Language Studies*, Vol. 10(3), 15-33.
- Kementerian Pendidikan Malaysia. (2013). *Pelan Pembangunan Pendidikan Malaysia 2013-2025 (Pendidikan Prasekolah Hingga Lepas Menengah)*. Retrieved September 23, 2022, from <https://www.moe.gov.my/index.php/dasarmenu/pelan-pembangunan-pendidikan-2013-2025>
- McArdle, G.E.H. (1998). *Conducting a Needs Analysis*. Menlo Park, CA: Course PTR.
- Mohd Paris Saleh & Saedah Siraj. (2016). Analisis Keperluan Pembangunan Model Pengajaran M-Pembelajaran Mata Pelajaran Sejarah Sekolah Menengah, *Jurnal Kurikulum & Pengajaran Asia Pasifik*, Bil. 4, Isu 4, 12-24.
- Muhammad Najib Jaafar, Zulkipli Md Isa, Wahida Mansor, Arnida Abu Bakar & Zainal Abidin Hajib. (2018). Cabaran Dan Keyakinan Pelajar Melayu Terhadap Pengajaran Dan Pembelajaran Bahasa Arab Di Sekolah Menengah. *Ulum Islamiyyah*, Vol. 23, 50-60.
- Muhammad Ridhuan & Saedah Siraj. (2010). M-Learning for Future Curriculum: Prospect and Implementation. *International Journal of Multidisciplinary Thought*, 1(2): 1 - 11.
- Nadwah Daud & Nadhilah Abdul Pisal. (2014). Permasalahan Pertuturan Dalam Bahasa Arab Sebagai Bahasa Kedua. *GEMA Online® Journal of Language Studies*, Volume 14(1).
- Norfaezah Mohd Hamidin. (2019). Challenges in Teaching and Learning Arabic Language in Secondary School: Students', Teachers' and Parents' View. *Journal of Social Sciences and Humanities*, Vol. 16, No.2, 1-14.
- Nurwaina Rasit & Zawawi Ismail. (2019). Kebimbangan Berbahasa Lisan Murid Bahasa Arab di Sekolah Menengah Agama di Malaysia, *Jurnal Administrasi Pendidikan*, 26 (2), 283-294.
- Shahida Naz, Memona Rasheed & Tahir Rasheed. (2019). *The Role of Smartphones in Learning English: A Study of Learners' Perspectives*. International Conference on Research in Humanities, London-United Kingdom.
- Tschannen-Moran, M. & Garies, C. R. (2004). Principal's Sense of Efficacy: Assessing A Promising Construct. *Journal of Educational Administration*, 42 (5): 573-585.
- Wan Azura Wan Ahmad, Lubna Abd Rahman, Arnida A. Bakar & Ahmad Pangidoan Nasution Mandily. (2007). *Pendekatan dan Strategi Efektif Dalam Penguasaan Bahasa Arab*, Bandar Baru Nilai: Penerbit Universiti Sains Islam Malaysia.
- Witkin, B. R (1997). Needs Assessment Kits, Models and Tools. *Educational Technology*, 17(11).
- Zati Azmina Jaafar. (2014). *Strategi Kemahiran Bertutur Bahasa Arab Dalam Kalangan Pelajar Tahun Asas Bahasa Arab KUIS*. (Tesis Master Tidak Diterbitkan). Universiti Kebangsaan Malaysia.

أسباب هلاك الوقف وطرق حمايته " الأوقاف الليبية أمودجا "

عبد العزيز محمد الشيباني

Universiti Sains Malaysia
aziz.alshibany@gmail.com

عتيق الله عبد الله

atik@usm.my

ثريا أحمد

thuraya@usm.my

الملخص

يسعى هذا البحث إلى دراسة مسألة هلاك الوقف وتعطل منافعه بنماذج معاصرة من الأوقاف كعينة للدراسة، حيث يعد الوقف من أهم التبرعات وأكثرها تأثيراً على المجتمعات وحضارتها الإسلامية، وفي بقاءه استمرار للمنافع، وفي هلاكه العكس، لذلك كان التأيد هو الأصل فيه، والمقصد الشرعي منه. وعلى الرغم من ذلك حدث وأن تعرض الوقف للهلاك والتعطل في البلدان الإسلامية. ومن هنا برزت مشكلة البحث في معرفة الأسباب التي أدت بالوقف إلى الهلاك، ومنافعه للتعطل، بُغية تحديد مرجعيتها، ومن ثم محاولة الوصول إلى طرق حمايته منها بإيجاد الحلول والوسائل المناسبة. وقد اعتمد الباحث على المنهج التحليلي الاستقرائي من خلال جمع واستقراء المسائل والأقوال الفقهية المتعلقة بالوقف وتعرضه للهلاك، ومن ثم النظر فيها وتحليلها بالتركيز على أسباب تعرض الوقف للهلاك ومرجعيتها، وأخيراً السعي إلى إيجاد الحلول المناسبة بناء على ما تم جمعه وتحليله من معلومات. ويتحدد البحث بدراسة مسألة هلاك الوقف دون انتهائه، حيث أن انتهاء الوقف أعم من هلاكه، كما تتحدد عينة الدراسة بالبيئة الليبية. وقد خلصت الدراسة إلى عدة طرق لحماية الوقف من الهلاك والتعطل، منها اللجوء إلى القضاء لإعادة المعتدى عليه بالتتمليك والتزوير، أيضاً السعي إلى تحصيل وثائقه التي تحفظه بما أمكن من الأساليب، والتعامل مع الجهات الأمنية والقضائية لردع المعتدين، ووضع خطط بعيدة المدى، وتحسينها بما يضمن اتباع الحكومات والقياديين لها لا لهواهم، وإيجاد الرقابة التي تتابع تنفيذ قوانين الوقف وأعماله، والعمل على توعية الناس إعلامياً بجرمة الاعتداء على الوقف، ونحوه من الطرق التي تحفظ الوقف من الهلاك والتعطل، وتساهم في مسيرته التنموية والحضارية.

الكلمات المفتاحية: هلاك، أسباب، طرق حماية، الأوقاف الليبية.

المقدمة

الحمد لله رب العلمين، والصلاة والسلام على خاتم الأنبياء والمرسلين، سيدنا محمد وعلى آله وصحبه أجمعين، وبعد!

إن نعم الله Y علينا وآلاءه لا تُحصى ولا تُعد، قال تعالى: ﴿وَإِنْ تَعُدُّوا نِعْمَةَ اللَّهِ لَا تُحْصُوهَا﴾ [النحل: 18]، ومن تملككم نعم أن شرع لنا الوقف من جملة التشريعات الإسلامية، ليكون سبباً في تحصيل البر والثواب للواقفين من أهل الخير المقتدرين، وسبباً في إعلاء كلمة الله ونشر الدعوة والدين، وردفاً وعاوناً للفقراء والمساكين والمحتاجين، وسبباً في حضارة المسلمين، بما يحققه من

إسهاماتٍ جلييلةٍ في مختلف المجالات الدينية، والاجتماعية، والتعليمية، والصحية، والعسكرية وغيرها، حتى قيل أن الوقف قد غطى جميع نواحي الحياة، والناظر في التاريخ الإسلامي يتجلى له ذلك بكل وضوح.

ولا يمكن للوقف أن يحقق أهدافه وغاياته ومقاصده التي وُضع من أجلها إلا إذا تمتع بنظام قوي يجنبه الهلاك والتعطل، ويمكنه من البقاء والاستمرار في إيتاء أكله ومنافعه بما يحقق مصالح المسلمين، من خلال المحافظة على أصله، وتنميته، وإدارته بشكل جيد، والأخذ بالأسباب الموصلة إلى ذلك، وإذا حدث وأن طالته أيدي الفساد والتخريب والاعتداء، فإنه حتماً سيكون عرضةً للهلاك والفناء، بما لا يمكنه معها القيام بغرضه ومقصده الوقفي الذي وُضع لأجل تحقيقه.

وإذا ما استقرينا وتبعنا تاريخ الأوقاف، فإننا- للأسف- سنجد أن كثيراً منها قد تعرض للهلاك والتعطل، ويرجع ذلك إما لسبب أو لعدة أسباب، منها تعرضه للاعتداء والتلاعب والفساد، وضعف الإدارة، وقلة الموارد والأرباح، ونحوه مما يؤثر عليه بالسلب، ويؤدي به إلى الضعف والهلاك وتعطل المنافع، ألا وهي معضلة الوقف الكبرى، ومن بين الأوقاف التي تعرضت للهلاك بعض الأوقاف الليبية، حالها كغيرها من الأوقاف في العالم الإسلامي، ومن هنا فإن الدراسة تتمحور حول التوصل إلى أسباب هلاك الوقف، ومن ثم محاولة إيجاد الطرق المناسبة لحمايته منها، من خلال دراسة الحالة الليبية كنموذج للبحث.

هذا وتوجد عدة دراسات وكتب وفتاوى تناولت موضوع تعرض الوقف للهلاك والتعطل قديماً ومعاصراً، غير أنها تختلف عن دراستنا من وجه أو عدة أوجه، نورد منها التالي:

دراسة سامي محمد الصلاحيات، بعنوان أسباب انتهاء الوقف الخيري وكيفية المحافظة عليه، سنة 2017م، حيث تناولت الدراسة الموضوع بتمهيد ومبحثين، كانت عن عينة وقفية تعنى بشؤون القُصّر في دبي، تناول التمهيد مفهوم وأسباب زوال الأوقاف الخيرية، وكان المبحث الأول عن معايير انتهاء الوقف، من حيث تقسيمها وبيان كل منها، أما المبحث الثاني فكان عن كيفية الحفاظ على الوقف من كل ما يؤدي به إلى الانتهاء ويحد من منفعتة؛ من الملاحظ أن الدراسة كانت عن انتهاء الوقف بالعموم، كما تحددت بوقف القصر في دبي، أما دراستنا فإنها تتناول هلاك الوقف دون انتهائه، كما تتعلق بالبيئة الوقفية الليبية.

دراسة تركي القحطاني، بعنوان انتهاء الوقف: مفهومه، أسبابه، حالاته، أحكامه، سنة 2017م، حيث تناولت الدراسة موضوع انتهاء الوقف بتمهيد ومبحثين، حيث تناول التمهيد مفهوم انتهاء الوقف، وأسبابه، وأقسامه، أما المبحث الأول فكان عن أحوال انتهاء الوقف، من حيث تعلقها بأركان عقد الوقف، أو أمور خارجة عنه، كما كان المبحث الثاني عن الأحكام المترتبة على انتهاء الوقف، ومن الملاحظ أن الدراسة قد ركزت على الأحكام الشرعية المترتبة على انتهاء الوقف، أما دراستنا فتختلف عنها بتناول هلاك الوقف، من حيث الأسباب وطرق الحماية، في حدود البيئة الوقفية الليبية. وتم وضع خطة البحث كالتالي:

التمهيد: نبذة عن الوقف وهلاكه

سيتم التمهيد للبحث بنبذة عن محوره الأساسي، وهو هلاك الوقف وتعطله، ببيان مفهوم الوقف وهلاكه، مع ذكر بعض الجزئيات التي تعطي القارئ فكرة عن الوقف، وعن تعرضه للهلاك والتعطل، كالتالي:

المطلب الأول: نبذة عن الوقف

والمراد به هنا الوقف الإسلامي، بأسسه وقواعده وضوابطه الشرعية والمقاصدية، لا الوقف عند الأمم الأخرى، لأنها وإن عرفت الوقف فهي لم تعرفه بهذه النظرة وهذا الشكل والتوسع الذي أتى به الإسلام، لهذا قال الإمام الشافعي: "ولم يحبس أهل الجاهلية فيما علمته داراً ولا أرضاً تبرراً بحبسها، وإنما حبس أهل الإسلام" (الشافعي، 1990م، 54/4)، أي لم يحبس أهل الجاهلية على أوجه البر المختلفة، كالتعليم والصحة وسد احتياجات الناس، وتوفير الخدمات ونحو ذلك، ومن هنا سنبين مفهوم الوقف لغة وشرعاً كالتالي:

أولاً- تعريف الوقف: وهذا يتطلب تعريفه وبيان مفهومه لغةً وشرعاً، كالتالي:

الوقف لغةً: بفتح فسكونٍ مصدر وَقَفَ الشيء وأوقفه، بمعنى حبسه وأحبسه، والجمع أوقاف وأحباس، ومنه قولك: وقفتُ الدابة، أي منعتها من السير وحبستها، أما أوقفت فهي لغة رديئة. (انظر: ابن منظور، 1414هـ، 359/9. معجم لغة الفقهاء، 1988م، 508/1).

الوقف شرعاً: عرفه الفقهاء بعدة تعريفات تبعاً لاختلافهم في حقيقته ومسائله وجزئياته، نذكر منها مفهومنا للوقف وفق المذاهب الأربعة، دون التطرق للتفصيلات التي من الأفضل أن تترك في مواضعها، وبالتالي فهو: "تحبس العين والتصدق بمنفعتها"، أي تحبب العين أو الرقبة أو الأصل ومنع التصرف فيها بالبيع والهبة والتوريث ونحوه من تصرفات الملك، والتصدق بمنفعتها، أو تسهيل ثمرتها على أوجه البر المختلفة، لقوله ρ لعمر بن الخطاب: "إن شئت حبست أصلها، وتصدقت بها"، (البخاري، 1422هـ، 198/3).

ثانياً- مشروعية الوقف: الوقف مشروع وثابت بالأدلة القرآنية، والآثار النبوية، وإجماع الأمة.

القرآن الكريم: أدلة الوقف كثيرة ومستفيضة، وهي داخلة تحت عموم النصوص القرآنية التي تحت على الإنفاق في سبيل الله، وفعل الخيرات، والإقراض الحسن. منها قوله تعالى: ﴿لَنْ تَنَالُوا الْبِرَّ حَتَّى تُنْفِقُوا مِمَّا تُحِبُّونَ﴾ [آل عمران: 92] وقوله: ﴿وَأَنْفِقُوا فِي سَبِيلِ اللَّهِ﴾ [البقرة: 195] وقوله: ﴿مَنْ ذَا الَّذِي يُقْرِضُ اللَّهَ قَرْضًا حَسَنًا فَيُضَاعِفَهُ لَهُ أَضْعَافًا كَثِيرَةً﴾ [البقرة: 245].

السنة النبوية: وردت كثير من الآثار النبوية الدالة على مشروعية الوقف والندب إليه، نذكر أشهرها، وهو حديث ابن عمر، وهو: أن عمر بن الخطاب أصاب أرضاً بخير، فأتى النبي ρ يستأمره فيها، فقال: يا رسول الله، إني أصبت أرضاً بخير لم أصب مالا قط هو أنفس عندي منه، فما تأمرني به؟ قال: إن شئت حبست أصلها، وتصدقت بها، قال: فتصدق بها عمر، أنه لا يباع أصلها ولا يُبتاع ولا يورث ولا يوهب، قال: فتصدق عمر في الفقراء، وفي القرى وفي الرقاب، وفي سبيل الله، وابن السبيل، والضيف لا جناح على من وليها أن يأكل منها بالمعروف، أو يطعم صديقاً غير متمول فيه) (سبق تحريجه)، وهو أصل في مشروعية الوقف كما ذكر ابن حجر (ابن حجر العسقلاني، 1379هـ، 402/5).

الإجماع: قد انعقد إجماع الأمة على مشروعية الوقف، ومما يعضده أقوال الفقهاء والأئمة، ومنهم الإمام الترمذي عند تعليقه على حديث ابن عمر السابق بما نصه: "والعمل على هذا عند أهل العلم من أصحاب النبي ρ وغيرهم، لا نعلم عند المتقدمين منهم في ذلك اختلافاً في إجازة وقف الأرضين وغير ذلك" (الترمذي، 1998م، 53/3)، ومما يؤكد الإجماع أيضاً عمل الأمة وانتشار الأوقاف في كافة البلدان الإسلامية.

ثالثاً- حكم الوقف: الوقف من أعظم أعمال الخير والتقرب إلى الله تعالى، وهو من المندوبات التي حث عليها الشرع، ورجب الناس فيها، وقد نُقل حكم الندب عن جمهور العلماء، (النفاوي، 1995م، 160/2)، وإذا ما نقل الندب دون تعيين القائل فاعلم أنه قولٌ مشهور لا يُحتاج إلى ذكر قائله، وقد يعتز به حكم الوجوب إذا كان على سبيل النذر، كقوله: إن شفى الله مريضاً كان نذراً على أن أقف كذا.

رابعاً- أنواع الوقف: للوقف ثلاثة أنواع باعتبار الموقوف عليه، وهي:

الوقف الخيري: وهو ما كان وقفاً على أوجه الخيرات المختلفة ابتغاء وجه الله تعالى، ومجالات هذا الوقف واسعة ومتعددة كالوقف على المساجد والمدارس والزوايا والتكايا والمكتبات والمستشفيات والطرق والجسور وماء السبيل ورعاية الحيوانات ونحوه، وهو أكثر أنواع الوقف انتشاراً.

الوقف الأهلي: وهو ما كان وقفاً على الأهل والذرية والأقارب، وقد اشترط بعضهم مآله إلى جهة خيرية وبعضهم لم يشترط ذلك. **الوقف المشترك:** وهو ما كان وقفاً على الأهل وأوجه الخير معاً، بحيث يجمع بين النوعين السابقين، فيكون جزء منه مخصص للأهل، وجزء مخصص لأوجه الخير المختلفة، وهو غالب وقف الصحابة ص .

هذا وهناك أنواع أخرى للوقف حسب الاعتبارات المختلفة، فينقسم إلى مؤبد ومؤقت، وأعيان ومنافع، وأصول واستثمارات، وشخصية طبيعية وحكومية، ونحوه. (انظر: أو غدة، وشحاته، 1998م، 50).

خامساً- أركان الوقف وشروطه: (انظر: الزحيلي، 7624/10)، سيتم تناول كل ركن من أركان الوقف الأربعة وشروطه وما يتعلق به تبعاً له، لتعلق الشروط بالأركان، كالتالي:

الواقف: وهو الذي يصدر عنه الوقف، سواء كان شخصية طبيعية أم حكومية، ويشترط فيه التالي:

- 1- البلوغ: فلا يصح الوقف من صبي ولو كان مميزاً؛ صوتاً لماله.
- 2- العقل: فلا يصح وقف الجنون والمعنوه والمختل والمغمى عليه؛ لفقدانهم العقل والتمييز.
- 3- الملك والحرية: بأن يكون مالكاً لوقفه ملكاً تاماً، فلا يصح وقف المال غير المملوك أو المملوك بعقد فاسدٍ أو المغصوب، ولا يكون مالكاً إلا إذا كان حراً؛ لأن العبد وما يملكه ملكٌ لسيده.
- 4- الاختيار: بأن يوقف بملك إرادته واختياره، فلا يصح الوقف من المكره.
- 5- عدم الحجر لسفهٍ أو دَيْن: فإن كان الحجر بسبب السفه فإنه لا يجوز وقفه، كونه ممنوعاً من التصرفات المالية، وقد أجاز بعضهم وقف السفه على نفسه وعلى جهات البر، لأن في ذلك صوتاً لماله، وإن كان بسبب الدَيْن فإنه لا يجوز وقفه إلا بإجازة الدائنين وموافقتهم، لعدم الإضرار بهم.
- 6- مرض الموت: لا يصح الوقف من مريضٍ مرض الموت، لأن ذلك يدخل في باب الوصية.
- 7- الردة: لا يصح وقف المرتد حال رده إلا بعودته للإسلام وتحديد وقفه.

وللواقف أن يشترط ما يراه عند وقفه، لأن الأصل في الشروط الجواز، بشرط أن تكون جائزة شرعاً، ولا تخل بأصل الوقف ومقتضاه، أما إن كانت كذلك فإنها ممنوعة، وتنقسم الجائزة إلى ما لا يجوز مخالفتها وما يجوز، كما تنقسم ممنوعة إلى ما يبطل الشرط والوقف معاً، أو الشرط فقط، وكل الأحكام المتعلقة بشروط الواقف من حيث جوازها وعدمه، وجواز مخالفة الشروط وعدمها تصب وتدور حول مصلحة الوقف، وذلك حماية له من كل ما يعرضه للهلاك والزوال، ومن أراد الاستزادة فليرجع إلى كتب الفقه. (انظر: الكبيسي، 1977م، 261/1)

الموقوف: وهو المال المراد وقفه أو تحبيسه، وشروطه كالتالي:

- 1- أن يكون مالاً متقوماً: والمقصود به كل ما له قيمة مادية أو معنوية، كالعقارات والمنقولات والمنافع والحقوق، وأن يكون المال الموقوف حلالاً غير محرم.
- 2- أن يكون مملوكاً: أي مملوكاً للواقف ملكاً تاماً، غير متعلق بحق الغير، ولا مغصوب.
- 3- أن يكون معلوماً: وعلمه يتحقق بمعرفة نوعه وصفه وكمه وحدّه وكل ما من شأنه رفع الجهالة واللبس حوله، إذ لا يصح وقف مجهول، لأن الجهالة تفضي إلى النزاع والخصومة.

الموقوف عليه: وهو المستحق لمنفعة الوقف وإليه تصرف، سواء كان معيناً أم جهة، ويعتبر هذا الركن هو الغاية من الوقف، وعليه فإنه يشترط فيه التالي:

1- أن يكون أهلاً للتملك: بأن يكون الموقوف عليه أهلاً للتملك حقيقة أو حكماً، كالفقراء والمساكين والمدارس والمستشفيات ونحوه.

2- أن يكون جهة بر: بأن يتم الوقف على جهة بر وخير يتقرب بها الواقف إلى ربه، لا على المعاصي والمنكرات، والحري، مع خلاف في المكروهات والمباحات.

3- التأييد وعدم الانقطاع: ومعناه أن يكون الموقوف عليه من شأنه التأييد وعدم الانقراض، كالفقراء والمدارس والمستشفيات ونحوه مما شأنه الدوام، وهذا الشرط للجمهور عدا المالكية، حيث أجاز المالكية الوقف على المنقطع، ويصرف الوقف على جهة مشابحة حال انقراض الموقوف عليه.

4- أن لا يعود على الواقف: وهذا الشرط محل خلاف، فقد منعه الجمهور قياساً على عدم جواز صدقة الإنسان على نفسه، وأجازته المالكية ومعيار أيوفي الخاص بالوقف، لقوله ρ : "ابدأ بنفسك فتصدق عليها" (مسلم، 692/2)، ولجواز اشتراط الواقف شيئاً من الوقف لنفسه.

الصيغة: وهو كل ما يعبر عن نية الواقف في الوقف، سواء بالعبارة أو الكتابة أو نحوه، لأن العبرة في المقاصد والمعاني لا الألفاظ والمباني، وشروطها كالتالي:

1- الجزم: ومعناه صدورهما من الواقف بصيغة جازمة خالية من الوعد والخيار والتردد.

2- التنجيز: أي غير معلقة على حدوث أمر ما، أو مضافة إلى المستقبل، وهذا شرط الجمهور، أما المالكية وبعض الحنابلة فأجازوها معلقة ومضافة قياساً على الوصية.

3- التأييد: والمقصود به خلو الصيغة من التأقيت، وهذا شرط الجمهور، أما المالكية فأجازوا الوقف المؤقت، لعموم النصوص التي تشمل الوقف المؤبد والمؤقت، وللتوسعة على المسلمين.

4- بيان مصارف الوقف: وذلك بتحديدتها وتوضيحها، والأولى أن تكون على صيانتها وتشغيلها بما يحقق دوامه واستمرار نفعه، ثم على أجرة النظار، ثم على الموقوف عليهم.

5- عدم اقترائها بشرط باطل: والشروط الباطلة هي التي تخل بأصل الوقف أو تنافي مقتضاه، ومثل هذه الشروط تبطل العقد.

سادساً- النظارة على الوقف: (أيوفي، 2019م، 1402)، وهي تُعنى بإدارة الوقف والنظر في شؤونه بما يحقق حفظ أصوله، وتنمية موارده وتكثيرها، وصرف غلته على الموقوف عليهم، سواء كان فرداً أو هيئة أو وزارة، والحكمة من النظارة بالغة الأهمية، حيث في عدم وجودها سيصبح الوقف مالاً سائماً بدون مالكٍ يديره ويحفظه ويستثمره وينميّه، وبالتالي ضياعه وزواله وهلاكه، وتعطل منافعه، وهو أمر ممنوع في الإسلام، وفي إيجاد النظارة القوية الآمنة حفظاً له من الضياع والهلاك، ولذلك كانت شروط الناظر كلها تصب في عدالته وأمانته وكفاءته وحسن تصرفه، أما وظائفه فتتمحور حول تحقيق مصالح الوقف بما يحفظه وينميّه، وهي كالتالي:

1- تنفيذ شروط الواقف، وقد سبق بيان أن الشروط التي يجب تنفيذها هي التي تراعي مصلحة الوقف، ولا تضر بأصله أو تنافي مقتضاه، وذلك حماية له من الهلاك والتعطل.

- 2- إدارة الوقف وصيانته واستثماره وتنميته بما يحفظ أصوله وينميها وفق الشرع، والاستعانة بالطرق المعاصرة في ذلك كالتأمين المشروع، والاستثمار الآمن، والاستعانة بأهل الخبرة في هذا المجال، كل ذلك بما يخدم مصلحة الوقف، ويحقق غايته، ويحميه من الهلاك والتعطل وقلة الموارد، ويضمن استمراره في تقديم الغاية المرجوة منه.
- 3- الدفاع عن الوقف، والمخاصمة عن حقوقه، بما يحفظه من الاعتداء والعبث والفساد، وضيع أصوله، وعدم خشية ذا منصب أو قرابة في ذلك.
- 4- صرف ريع الوقف وغلته في مصارفها بعد قبضها وتحصيلها، لإيصال منافع الوقف إلى مستحقيها، وتحقيق الغاية منه.
- 5- تطبيق مبدأ الشفافية والإفصاح، بما يُبعد الشبه عن الناظر، ويدفع عنه الوسواس في استغلال الوقف، والاستثمار بما يخفى عن الناس، وبالتالي فهو أدعى إلى تحقيق غايات الوقف وأهدافه.

المطلب الثاني: مفهوم هلاك الوقف وأقسامه

بعد تناول نبذة عن الوقف، فإنه يمكن تبين مفهوم هلاك الوقف، ومحوره البحث الأساسي كالتالي:

أولاً- مفهوم هلاك الوقف: قبل الشروع في هذا المفهوم يجب علينا التفريق بين انتهاء الوقف وبطلانه، فبطلان الوقف يعني أنه لم يكن صحيحاً من بدايته، بأن كان وقفاً على معصية، أو حربي ونحوه مما يبطل الوقف من أساسه، أما انتهاء الوقف فيعني أن الوقف صحيح المنشأ والتأسيس، غير أنه عرض له ما أدى به إلى الزوال والانتهاء، كتعليقه وتأقيته وهلاكه، (الصلاحات، 2017م، 205)، ومن هنا تبين لنا أن انتهاء الوقف أعم من هلاكه، وموضوع البحث متعلق بالهلاك دون انتهاء الوقف أو بطلانه، هذا ولم يجد الباحث - حسب اطلاعه المتواضع - تعريفاً لهلاك الوقف، وربما يرجع ذلك لوضوحه، ولذلك سيسعى لتعريف لهلاك الوقف، ويميزه عن البطلان والانتهاء، من خلال الجمع بين المعنى اللغوي والمفهوم الشرعي، كالتالي:

الهلاك لغة: بفتح الهاء، مصدر هلك، وهو خروج الشيء عن أن يكون منتفعاً به الانتفاع الموضوع له، (قلعجي، وفتحي، 494/1).

اصطلاحاً: بناءً على ما سبق من تعريف الوقف لغة وشرعاً، وعلى الجمع بين الكلمتين، وعلى المفهوم الشرعي للهلاك، فإنه يمكننا أن نستخرج مفهوماً لهلاك الوقف، وهو: "زوال العين الموقوفة، وتعطل منفعتها، حقيقة أو حكماً، لأسباب معينة".

ثانياً- أقسام هلاك الوقف: لهلاك الوقف عدة أقسام بحسب اعتباراته المختلفة، وبيانها كالتالي:

باعتبار الحقيقة: ينقسم هلاك الوقف بحسب اعتبار حقيقته إلى قسمين:

- 1- **الهلاك الحقيقي:** وهو تعرض عين الوقف أو منفعته للزوال والفناء حقيقةً، إما بسبب الزمن، أو سوء الإدارة، أو قلة الربح، أو نحوه مما يؤدي به إلى الزوال والهلاك.
 - 2- **الهلاك الحكمي:** وهو تعرض الوقف للهلاك حكماً لا حقيقةً، كالاقتداء عليه وتخريبه وغصبه، مما يجعله في حكم الهالك.
- باعتبار الكلية:** ينقسم هلاك الوقف باعتبار الكلية والجزئية إلى قسمين، وهما:
- 1- **الهلاك الكلي:** وهو ما هلكت فيه عين الوقف ومنفعته كلياً، بحيث لم يعد يرجى عودها.

2- الهلاك الجزئي: وهو ما هلكت فيه عين الوقف أو منفعته جزئياً، أو نسبياً، بحيث يرجى عودتها بتعمير بعضها، أو بيعه والعودة بالنفع على البقية.

باعتبار السبب: ينقسم هلاك الوقف باعتبار سببه إلى قسمين أيضاً، وهما:

1- عامل داخلي: وهو هلاك الوقف متأثراً بأسباب داخلية، كعامل الإدارة، أو قلة الربح، أو نحوه.

2- عامل خارجي: وهو هلاك الوقف بعامل خارجي، كغصبه، والاعتداء عليه، وتخريبه، أو بكارث طبيعية خارجة عن القدرة.

المبحث الأول: أسباب هلاك الوقف وطرق حمايته

بعد أن تم تناول نبذة تمهيدية عن الوقف، فإنه سيُشرع- بعونه تعالى- في بيان أسباب هلاك الوقف، وطرق حمايته منها، من خلال ما تناولته الكتب والأبحاث الفقهية المتعلقة بالوقف.

المطلب الأول: أسباب هلاك الوقف

من المعلوم أن الغرض من الوقف الدوام والاستمرار في إيتاء أكله بأصل ثابت وريع متجدد، ولكن غالباً ما يتعرض إلى التعطل والهلاك والزوال، ألا وهي معضلة الوقف، وإذا أردنا تفادي الوقوع فيها فإنه يجب علينا تشخيص الأسباب وتحديدتها أولاً للتوصل إلى حلها، وهي كالتالي:

أسباب متعلقة بالتوثيق: من الأسباب التي تؤدي إلى هلاك الوقف وتعطل منافعه، هو عدم توثيقه وتسجيله والإشهاد عليه، مما يجعله عرضةً للطامعين وأصحاب النفوس الضعيفة.

أسباب متعلقة بالنظارة: قد سبق بيان مفهوم الناظر، وشروطه، ووظائفه، وأن مهمته الأساسية المحافظة على الوقف من الضياع، وتنميته بما يعود بالمصلحة على الموقوف عليهم، ولكن قد يخل الناظر بشيء من وظائفه مما يتسبب في تعرض الوقف للتعطل والهلاك، ومن تلك الأسباب ما يلي:

1- عدم قدرة الناظر على إدارة الوقف وتنظيمه بكفاءة يتحقق معها تحصيل مصالح الموقوف عليهم، ومنها عدم قدرته التصرف بشكل حسن في النوازل التي تنزل بالوقف.

2- خيانة الناظر، وتصرفه في الوقف بما يخدم مصالحه الشخصية، كالتعدي عليه، وتزوير وثائقه، والتواطؤ مع الغير لتمليكها، والمحاباة والمحسوبية فيه، مما يؤدي بالوقف إلى الزوال.

3- إهمال الناظر للوقف، وعدم العمل على تنمية والاعتناء بشؤونه، كعدم تحصيل ريعه في وقته.

أسباب متعلقة بالموقوف: لا شك أن الموقوف الذي تم تحبسه يجب أن يفي بحاجات الموقوف عليهم، ويلبي الغاية الوقفية منه، وإلا فإنه سيتسبب في تعطل الوقف وهلاكه، ومن بين تلك الأسباب التالي:

1- عدم حسن اختيار الموقوف وفق الغاية الوقفية منذ البداية، كأن توقف أرض غير صالحة للزراعة على وقف ما، أو أوقاف غير دارة على وقف يحتاج إلى موارد كثيرة، أو نحوه مما لا يؤدي الغاية الوقفية منه على الوجه المقصود.

2- ضعف موارد الوقف وقتها، بما لا يحقق الغاية منه، ويؤدي به إلى التعطل والتهالك شيئاً فشيئاً.

أسباب خارجية: من بين الأسباب المفضية إلى هلاك الوقف وتعطله الأسباب الخارجية، وهي كالتالي:

- 1- الحروب والاقتيال الحاصل بين الدول والجماعات، مما يعرض الوقف للاعتداء والتخريب والنهب والسلب، وشواهد التاريخ كثيرة.
- 2- تغيير الحكام، وتغيير السياسات تبعاً لذلك، فمن المعلوم عند تغيير الدول أن الجديد منها يناهض القديم، ويسعى لمحو آثاره، قال تعالى: ﴿كُلَّمَا دَخَلَتْ أُمَّةٌ لَعَنَتْ أُخْتَهَا﴾ [الأعراف: 38]، ومن بين ذلك الوقف، مما يؤثر سلباً عليه، ويؤدي به إلى الضياع والهلاك والتعطل.
- 3- غصب الوقف، وذلك بامتلاكه بالطرق الغير مشروعة، إما بالقهر والغصب المباشر، وإما بالطرق المتتوية التي ظاهرها حق وباطنها باطل، كما حدث في بعض الأوقاف الليبية كما سيأتي لاحقاً.
- 4- تعرض الوقف للهلاك بالكوارث الطبيعية، كالزلازل والبراكين والأعاصير ونحوه من الأسباب الخارجية.

المطلب الثاني: الأحكام المتعلقة بحماية الوقف من الهلاك

بعد عرض أسباب هلاك الوقف، فإنه يتحتم بيان الأحكام الفقهية، والضوابط الشرعية المتعلقة بحمايته من الهلاك والتعطل، إما بالوقاية منه قبل وقوعه أو بعده، على قسمين كالتالي:

أولاً- الأحكام المتعلقة بالوقاية من الهلاك: وهي جملة من الأحكام التي تتوقى حدوث الضرر وتدفعه قبل وقوعه، حمايةً للوقف من الهلاك والضياع، تتناولها كالتالي:

توثيق الوقف: وذلك بالإشهاد عليه وتسجيله عند الجهات الحكومية المختصة، وهو من الأمور المهمة لحمايته من العبث والتزوير، والاعتداء والخسومة، والزوال والهلاك.

صفات الناظر: من خلال مراعاة مجموعة من الصفات يجب توفرها فيه، كالعدالة والأمانة والكفاءة وحسن التصرف كما سبق، والقصد من وجوب توفرها فيه لضمان إدارته للوقف بشكل مثالي يخدم مصلحة الوقف، ويضمن عدم تحيز الناظر أو محاباته لأحد من أقاربه، ولا يخفى ما في المحاباة من المفساد وتضييع الحقوق، ويمنع من التعدي على الوقف ببيعه وتزوير وثائقه أو عدم إظهارها عند المخاصمة ونحوه؛ وقايةً له من الضياع والهلاك، وتعطل المنافع والحقوق.

المصاريف التشغيلية: وهي المصاريف الأساسية المتعلقة بتشغيل الوقف، كالمشتريات اللازمة، ودفع أجور العاملين فيه، وأجور النقل، وتسديد ضرائبه الحكومية، ونحو ذلك مما لا بد منه لتشغيل الوقف وتحصيل غلته، وهي مقدمة على غيرها من المصاريف؛ وقايةً للوقف ومنفعته، ودفعاً لمفسدة تعطله، وقلة موارده، وربما هلاكه.

الصيانة الدورية: وهي الصيانة والعمارة التي تتم بشكل دوري، للعمل على إطالة عمر الموقوف، وحفظه من التعطل والهلاك قبل وقوعه، بدفع الضرر قبل تفاقمه، وهي شاملة لمختلف أنواع الموقوفات، كالعقارات والمنقولات والآلات ونحوها.

تخصيص مبلغ للصيانة: من الأفضل تخصيص مبلغ لما قد يطرأ من نفقات، أو للصيانة الوقائية من الهلاك، هذا إن وجد فائض من غلة الوقف بعد المصاريف الأساسية وأجرة النظارة والمستحقين للوقف، مع مراعاة عدم تضخم المبلغ، بل يخصص بمقدار المتوقع أو ما يعين على ما قد يستجد، وإن خصص ولم يطرأ شيء فإنه يجوز استثمار المخصص، والغرض منه إعانة الوقف على الدوام والاستمرار، ودفع شبح التعطل والهلاك والزوال.

استثمار الوقف: من المعلوم أن الأموال الموقوفة منها ما يكون وقفاً بذاته، ومنها ما يكون وقفاً للإنفاق على غيره، وتسمى بالأوقاف الاستثمارية، وهي التي يتم استثمارها وفق الشرع والإنفاق من عوائدها على الصيانة والنفقات المختلفة، بالإضافة لأصول الوقف، والإنفاق على أوجه الخير، والغرض منها استدامة الوقف واستمراره، وتكثير أرباحه، وتنمية أصوله، وعموم نفعه، وتوقي تعطله وربما هلاكه إن ضعفت أرباحه وتضاءلت بعدم الاستثمار والتنمية. (انظر: مجمع الفقه الإسلامي، 2004م، قرار رقم 140 (15/6)).

أجرة المثل: من بين أحكام توقي قلة موارد الوقف، وللحفاظ على أصله وربعه، ولمنع التلاعب به، اشتراط تأجيله بأجرة المثل، أي بنفس قيمة السوق، وإن أجره الناظر بأقل من أجرة المثل، فعليه ضمان النقص، أو فسخ إجارة الأول وتأجيلها للذي زاد. (الدسوقي، 95/4)

منع رهن الوقف: من الأحكام الفقهية المتعلقة بتوقي هلاك الوقف هو منع رهنه، لأن في رهنه تحييس لعين بدين لبيعها واستيفاء الدين منها، وبيع الوقف غير جائز.

إقراض مال الوقف: الأصل عدم جوازه، ولكن إذا كان في الإقراض مصلحة راجحة فيجوز، كحفظه من الهلاك والضياع، كما في إقراض مال اليتيم لحفظه من الهلاك، فعن ابن عمر أنه كانت تكون عنده أموال اليتامى فيستسلفها ليحزها من الهلاك. (البيهقي، 2003م، 466/6)

ثانياً- الأحكام المتعلقة بدفع الهلاك: وهي جملة من الأحكام الموضوعية لدفع الهلاك أو الضرر الحاصل في الوقف، والذي فاتت مرحلة توقيه، وكان لزاماً دفعه بأخف الأضرار، وهي كالتالي:

عزل الناظر: من الأحكام المتعلقة بحفظ الوقف، وصيانته من الهلاك والضياع والعبث، عزل الناظر إذا ثبتت عنه تهمة الخيانة أو التقصير أو التعدي على الوقف، وذلك من قبل القاضي أو من يمثله، لأن في إبقائه مع ما سبق من صفات هلاك وضياع للوقف.

الصيانة الضرورية: وتكون للأوقاف المالكة أو المتعطل، وهي من الأحكام الواجبة لحفظ الوقف من الهلاك، ودفع المفسدة عنه بعد وقوعها، لأن في عدم المبادرة إلى صيانة المتهالك هلاك محتم، ومما يبين ضرورتها تجويز الاستدانة لهذا الغرض في الحالات الضرورية كما سيأتي.

الاستدانة على الوقف: تعتبر الاستدانة من الأحكام المتعلقة بدفع الهلاك والضرر الواقع على الوقف، حيث أن الأصل عدم جوازها، ولكن جوازها الشرع في الضرورة حفظاً للوقف من الهلاك ودفعاً للضرر الواقع عنه، ومن حالات جوازها العمارة الضرورية لأصل من أصول الوقف تعرض للهلاك أو الخراب، أو في حال تعطل الوقف بسبب عدم دفع إحدى النفقات الأساسية، أو نحوه مما لا بد منه لبقاء أصل الوقف، ودوام نفعه.

استبدال الوقف: وهو من الأحكام التي أجازها الشرع للضرورة، حفظاً للوقف من الهلاك، ومنعاً له من التعطل والخراب، حيث أن الأصل أن الوقف لا يُباع ولا يُشترى ولا يُستبدل، ولكن إذا خرب وهلك، أو تعطلت منافعه، بما لا يمكن معها إصلاحه وإعادة عمارته من غلته، أو يبيع بعضه للإنفاق على الباقي جاز استبداله بما هو أنفع بموافقة القاضي؛ لئلا يتم إبطال الأوقاف بالبيع، ويجب عدم الاحتفاظ بالمال وشراء غيره فوراً؛ لئلا يضيع المال، ولدفع الشبه عن الناظر، كل هذه الأحكام متعلقة بحفظ الوقف، ودفع مفاسد هلاكه وتعطله، وجلب مصالحه.

نقل الوقف: إذا تعطلت منفعة الموقوف ولم يكن سبيل إلى نفعه واستمراره إلا بالنقل فإنه يجوز، وذلك صوتاً له من الضياع وتحقيقاً لنفعه، كما قال ابن رشد، بجواز معاوضة الأرض الخربة التي انقطعت منفعتها ولا يمكن عمارتها بأرض سواها، بشرط ثبوت تعطلها، والغبطة، والإشهاد على النقل، (المواق، 1994م، 662/7)

تغيير شكل الوقف: أي تغيير الوقف من شكل تعطلت منفعتة إلى شكل آخر للمصلحة، كتغيير طاحونة خربة إلى دكان مثلاً للمصلحة الراجحة، كما جاء في الذخيرة: "له تغيير الوقف إلى ما هو أفضل للعبد ولو نقل الحيوان إلى ما ليس أفضل امتنع، لأننا جوزنا النقل مع كونه على خلاف وضع الوقف لأجل ضعف الوقف فيه والمصلحة للأرجح" (القرائي، 1994م، 332/6).

المبحث الثاني: تعرض الأوقاف الليبية للهلاك: الأسباب وطرق الحماية

يهدف هذا المبحث إلى تسليط الضوء على عينة البحث وهي الأوقاف الليبية، بإثبات ما تعرض منها للهلاك بحسب ما أمكن، ومن ثم دراسة أسبابه، مع محاولة التوصل إلى طرق حمايته منها، وقبل البدء في المبحث تجدر الإشارة هنا إلى أن الأوقاف عندنا لا تطبق مبدأ الإفصاح والشفافية، ومن الصعب الحصول على معلومات كهذه، ولكن سيسعى الباحث إلى توفير ما أمكنه من معلومات حسب جهده المتواضع.

المطلب الأول: نبذة عن الأوقاف الليبية وتعرضها للهلاك

يتناول هذا المطلب نبذة تعريفية مختصرة عن الأوقاف الليبية، من حيث تاريخها، وإدارتها خلال الدول المتعاقبة، مع محاولة إثبات ما تعرضت له من حالات أدت بها إلى الهلاك والتعطل والضعف.

أولاً- نبذة عن الأوقاف الليبية

الأوقاف الليبية شأنها شأن بقية الأوقاف في العالم الإسلامي، من حيث النشأة والتطور، والظروف والعوامل المحيطة بها، حيث عرفت البلاد مع وصول الفتح الإسلامي إليها سنة 23هـ، ومنذ ذلك الوقت كانت تدار من قبل الخلافات والدول الإسلامية المتعاقبة على البلاد كغيرها من الولايات والأقطار الإسلامية، وبعد سقوط الخلافة العثمانية احتلت الدول الأوروبية الدول الإسلامية طمعاً فيها وعداوةً للإسلام، فاحتلت إيطاليا ليبيا سنة 1911م، وتدخلت في الأوقاف بطرق سياسية خبيثة تخدم مصالحها الاستعمارية، فتدخلت في نظارة الوقف، وغيرت بعض مصارفه بما يخدم مصالحها، وبعد نيل الاستقلال سنة 1951م، اهتم العهد الملكي بتنظيم الوقف، وأصدر عدة قوانين تعطي الوقف شخصيته الاعتبارية، وتنظم أحكامه وشؤونه، وتقدم له الحماية، مما نتج عنه انتعاش في الأوقاف إلى حد ما، وبعد انقلاب القذافي العسكري على المملكة سنة 1969م، صدر قانون يقضي بتأسيس الهيئة العامة للأوقاف للنظارة عليها وإدارتها، كما يقضي بإلغاء الوقف الذري، وفي هذه الحقبة كانت البلاد تعتمد على النفط في الدخل ولازالت، فتراجع دور الأوقاف كثيراً، وحصل الاعتداء عليها بالتمليك والتخصيص، وبعد الإطاحة بجمهورية القذافي سنة 2011م، صدرت عدة قوانين لتنظيم الأوقاف، وأصبح للوقف وزارة لأول مرة في تاريخ ليبيا، تضم عدة إدارات تدير الوقف وتهتم بشؤونه.

هذا وتعد ليبيا من البلدان التي تزخر بالوقف، حيث بلغ عدد المحصور من الموقوفات 12000 أصلاً عقارياً، نصفها أوقاف ريعية، غير أن المستغل منها لا يتجاوز الربع، والربع لا تتجاوز قيمة استغلاله الربع من قيمته السوقية لعدة عوامل، كما سيأتي لاحقاً. (طالبة، 2-4).

ثانياً- تعرض الأوقاف الليبية للهلاك والتعطل

من المعلوم تاريخياً أن الأوقاف لا تخلو من التعرض للهلاك والعبث والضعف، ويرجع ذلك إما لسبب أو عدة أسباب كما سيأتي، والوقف في ليبيا تعرض للحالات السابقة كغيره، والكلام الذي نسمعه عن التلاعب بالوقف كثير، ولكن نورد الحالات التي أمكن الاطلاع عليها وإثباتها، كما يلي:

الحالة الأولى: استفتاء رئيس الهيئة العامة للأوقاف لدار الإفتاء الليبية بشأن الأوقاف المعتدى عليها من قبل نظام القذافي السابق، ونصه: "كما تعلمون، فإن عقارات الوقف كانت مستباحة من النظام السابق، كما هو الحال في أملاك الناس، وكان التصرف فيها يتم بموجب رسالة من جهات سيادية، تفرض تخصيص هذا العقار أو هذه المنطقة لجهة أو أفراد، وكان أحياناً- من باب التلاعب- يتم بصورة البيع والشراء، أي تودع أموال زهيدة جدا في خزانة الوقف، للإيهام بأن العقار قد باعتته الأوقاف، وهو في الحقيقة بيع بدون إرادتها، والسؤال المطروح: ما الذي ينبغي فعله الآن؟ هل نطالب بالتعويض ببدل عنها مما تملكه الدولة من عقارات ملكاً حقيقياً، أم باسترداد ما يمكن استرداده؟"، (دار الإفتاء الليبية، 2017م، فتوى رقم: 3358).

من النص المستفتى به من قبل المسؤول الأول عن الأوقاف يتضح كبر التلاعب بالأوقاف بالبيع الصوري والتخصيص المباشر من الجهات السيادية، وذلك لأن النص لم يحدد حالة أو بضع حالاتٍ بعينها، وإنما عمم، والتعميم هنا يفيد شيوع الفعل وانتشاره وشهرته، كما أن هناك فتاوى وأبحاث أخرى تحدثت عن تعرض الوقف للاعتداء، مما يبين تفاقم المشكلة.

الحالة الثانية: ما كتبه مدير الأوقاف السابق والمهتم بشؤون الوقف الدكتور مصطفى طابطة، في بحثه الذي أكد فيه انحسار الأوقاف وتعرض كثير منها للاعتداء بالتملك والتخصيص، أيضاً أفصح عن ضياع أغلب الوثائق والسجلات الوقفية، بالكل أو الجزء، مما أدى إلى العجز عن الدفاع عن الوقف وقضاياه أما القضاء. (انظر: طابطة، 2-5). ومما يؤكد ذلك أن الباحث نفسه سمع خطيب الجمعة- بناء على طلب من مكتب الأوقاف بالمنطقة- يطلب من كل من له علم بالوقف المبادرة إلى إعلام مكتب الأوقاف به؛ لتسجيله وحصره.

يتضح مما سبق مدى التلاعب والعبث بالوقف في ليبيا، وتفويت أصوله بالتملك والتخصيص، وضياع وثائقه وسجلاته، وربما بفعل فاعل.

الحالة الثالثة: التقرير المنشور للباحث والمهتم بشؤون ليبيا فريدريك ويرى، الذي كان محوره الأساسي تعرض الأوقاف الليبية للصراع والنزاع للسيطرة من قبل الجماعات الإسلامية المسيية والموجهة من دول خارجية، وتدايعات ذلك الأمر السلبية على الأوقاف، كما أشار هو الآخر تعرض الأوقاف الليبية للاعتداء على أصولها بالتملك، من قبل نظام القذافي، ومن قبل بعض المواطنين بعد ثورة فبراير، كما أشار إلى عدم وجود السجلات الدقيقة التي تبين ملكية الأصول الوقفية بما يرفع النزاع، الأمر الذي جعل الأوقاف عرضة للاعتداء، وأثر عليها سلباً، وعرقل مسيرتها. (انظر: ويرى، 2022م).

أكد هذا التقرير الأمر نفسه، وهو تعرض الأوقاف الليبية للاستيلاء على أصولها العقارية بالتملك والتخصيص من قبل الجهات السيادية السابقة، أو المواطنين بعد التفلت الأمني في البلاد.

الحالة الرابعة: التحقيق الصحفي لصحيفة العربي الجديد- بنغازي، والذي أظهر كمية الاعتداءات على الأوقاف في المنطقة الشرقية، وهو ما يسمى "الهلت"، بمقابلات أجراها كاتب التحقيق مع مسؤولين لهم علاقة بالأوقاف، وذلك بعد حادثة اعتداء أسرة ليبية اعتدت على أرض وقفية بقوة السلاح بمدينة البيضاء، وكما نقل عن مدير مكتب أوقاف الجبل الأخضر أن التقديرات الأولية تشير إلى ضياع ثلاثة أرباع مساحات الوقف الكلية! حيث أن كثيراً من المنشآت والأحياء والأسواق قائمة على أراض وقفية لازالت تحت تصرف المعتدين عليها، كما صرح بأن مطار الأبرق وجامعة عمر المختار القديمة وبعض المعسكرات تقع على أرض وقفية استغلها نظام القذافي في بناء المنشآت العامة، كما استغل غيرها لحاشيته، وأنه قلق من أنها أصبحت واقعا مريرا يصعب التعامل معه، أيضا

قابل صاحب التحقيق شيخ زاوية الجبل الأخضر، ونقل اتهامه لنظام القذافي في تخريب الوقف، وذكر عبارة قالها رئيس وزرائه عن الأوقاف السنوسية إن اعترضت التخطيط العام، بما معناه: "لتذهب كما ذهب الملك"، كما أعرب عن حزنه على الأوقاف الواسعة التي تم الاعتداء عليها بعد ثورة فبراير وما صاحبها من انفلات أمني نتيجة انتشار السلاح. (صحيفة العربي الجديد، 2015م). يظهر جلياً مدى الاعتداء على الأوقاف، خاصة في ظل انتشار السلاح وضعف الأمن حالياً، كما يظهر أن هذا الأمر ليس بالجديد، حيث كان النظام السابق ينتهج تخصيص الأوقاف وتمليكها، وإنشاء المنشآت العامة عليها، مما جرّأ ضعاف النفوس على الوقف، وأصبح الحال كالأمر الواقع.

المطلب الثاني: أسباب تعرض الأوقاف الليبية للهلاك وطرق حمايتها

بعد عرض بعض الحالات التي تعرض فيها الوقف للهلاك والتعطّل، فإنه من المهم السعي إلى تسليط الضوء على الأسباب التي أدت إلى ذلك، مع محاولة التوصل إلى طرق حمايتها.

أولاً- أسباب تعرض الأوقاف الليبية

هناك عدة أسباب وعوامل - مباشرة أو غير مباشرة- أدت بالوقف إلى الهلاك والتعطّل والضياع، يمكن بيان أبرزها من خلال ما سبق إثباته من حالات الاعتداء والتلاعب بالوقف، وما أمكن الاطلاع عليه من أبحاث ومواضيع، أو ما تم سماعه من قبل الباحث نفسه، وهي كالتالي:

1- استغلال السلطة والنفوذ: يعتبر استغلال قوة السلطة والمنصب في تحقيق مكاسب شخصية أو حزبية من أبرز عوامل الاعتداء على الوقف في ليبيا بالتمليك والتخصيص، ومن أكبر أسباب هلاكه وتعطله، وساعد في ذلك ضعف النظام الإداري، وتفشي الفساد والمحاباة، وغياب الوازع الديني، وقد سبق إثبات حالات التمليك بشكل مباشر، أو بصورة البيع والشراء، بنقولات ثابتة عن المسؤولين ومن لهم علاقة بالأوقاف وإدارتها.

2- ضعف التوثيق والحصر: من أهم الخطوات التي تحافظ على الأصول الوقفية من الهلاك والتعطّل، وتمنع النزاع حولها، هي توثيقها، وتسجيلها لدى الجهات المختصة، والإشهاد عليها، وفي العكس تسبّب في هلاكها وضياعها، وعجز عن الدفاع عنها أمام القضاء، وتفويت لأصولها ومنافعها، وإطماع لأصحاب النفوس الضعيفة بها، ولا يخفى ما في هذا كله من المفاسد.

3- الفوضى الأمنية: تعتبر المشاكل الأمنية التي تعيشها البلاد من بين الأسباب التي أثرت على الوقف بالسلب، وعرضته للهلاك والاعتداء، كحالة الاعتداء على الأرض الوقفية في مدينة البيضاء، وما ترتب عليها من اشتباكات مسلحة بين قوة الأمن والعائلة المعتدية.

4- تغيير الحكومات واختلاف التوجهات: غالباً ما تحمل الحكومات المتعاقبة على بعضها، وتلعب اللاحقة منها السابقة، وتعمل على محو ذكرها، كما هو الحال عند اختلاف التوجهات الفكرية، وقد سبق نقل عبارة رئيس وزراء القذافي التي ربط فيها وقف الزوايا السنوسية بالملك إدريس السنوسي! مغالطة منه في تشخيص الأمور وتسييسها، وهو ما لا ينبغي في الوقف، الأمر الذي من شأنه أن يربك الوقف، ويهدم الجهد، ويهدر الوقت، ويكون سبباً في تعطيل الوقف مدة لا بأس بها.

ثانياً- طرق حماية الأوقاف الليبية من الهلاك والتعطّل

من خلال ما تم عرضه من أسباب أدت بالوقف في ليبيا إلى الهلاك والتعطّل والضعف والجمود، فإن الأمر يستلزم إيجاد حلول وطرق مناسبة لهذه المشاكل أو التقليل منها على الأقل، وهي كالتالي:

- 1- رفع وزارة الأوقاف دعاوى ضد المعتدين على الوقف تطالبهم بإعادته، مع تحميلهم تبعات الاعتداء عليه، فإن تعذر فإنهم يطالبون بمثل الوقف المعتدى عليه أو أفضل، لا أقل منه قيمة، لقوله p: "على اليد ما أخذت حتى تؤديه"، (النيسابوري، 1990م، 2302/55)، أيضا إعطاء الوزارة استقلالية أكبر، ومنحها حصانة أقوى؛ للوقوف ضد ذوي النفوذ والسلطة، والعمل توعية الناس في الخطب والدروس والإذاعات بحزمة وخطر الاعتداء على الوقف.
- 2- السعي إلى تحصيل الوثائق الوقفية، وحصرها وجمعها، برصد المكافآت، وتسيير اللجان للمناطق المختلفة في البلاد، والاستعانة بالمنظومات الالكترونية المعاصرة التي تسهل العمل وتضبطه، والاحتفاظ بنسخ منها، حتى لا يتعرض الوقف للضياع مستقبلاً.
- 3- حماية الوقف من الاعتداءات المسلحة من خلال القضاء والتعامل مع الجهات الأمنية الرسمية، وهي بدورها تخول الجهاز الأمني الذي تراه مناسباً للتعامل مع المعتدي، أيضا بالتشهير بالمعتدين إعلامياً، من خلال مواقع التواصل الاجتماعي، حيث أن البيئة اللببية تراعي هذه الأمور كثيراً.
- 4- وضع الخطط والاستراتيجيات الوقفية ذات المدى البعيد، وتحسينها شرعاً وقانوناً وعرفاً، بحيث تلتزم بها الحكومات المتعاقبة، وتعمل داخل إطارها، ولا يتعدها أحد أياً كان توجهه وتحزبه؛ حتى لا يهدر الوقت والجهد، وتكون الرؤية واضحة لمن سيتولى الأمر.
- 5- إعادة النظر في اللوائح والقوانين الخاصة بوزارة الأوقاف، بما يوجد جهات رقابية تُفعل القوانين الموجودة، وتُتابع تطبيقها على الطامعين المفسدين المخالفين.

الخاتمة

تناول هذا البحث موضوع هلاك الوقف بنبذة عن الوقف في الإسلام، وهلاكه، واستعرض أسباب هلاك الوقف بالعموم، وأتى بالأحكام الفقهية المتعلقة بحمايته منها، ومن ثم انتقل إلى عينة البحث وهي الأوقاف اللببية، بنبذة عنها، مع إثبات ما أمكن من حالات تعرض الوقف فيها للهلاك والتعطل، متناولاً أسبابها، ومقترحاً للحلول التي أمكن التوصل إليها لحماية الوقف في ليبيا من أسباب هلاكه وتعطله، وأخيراً خلص البحث إلى جملة من النتائج والتوصيات المدججة مع بعضها، كون التوصيات متمثلةً في النتائج المقترحة الموصى بها لتفادي الضرر الواقع وأسبابه، وهي كالتالي:

- 1- أن هلاك الوقف وتعطله يعد معضلة الوقف ومشكلته الكبرى، التي يجب حمايته منها بما أمكن، لتأدية رسالته السامية في النهوض بالأمة، والإسهام في حضارتها المجيدة.
- 2- تعرّض الأوقاف تاريخياً للهلاك والتعطل لعدة أسباب، منها ما هو متعلق بالتوثيق والحصر، أو بالنظارة ومهامها، أو بالموقوف وعدم كفاية ريعه، أو بأسباب خارجية كتأثره بالعوامل الزمنية والطبيعية، أو بالاعتداء عليه من قبل المفسدين والمخربين.
- 3- جاءت الشريعة الإسلامية بجملة من الأحكام المتعلقة بحماية الوقف قبل وقوع الهلاك والضرر أو بعده، وهي داخلة في معظم أحكامه، كتوثيق الوقف لحفظه من الضياع والخسومة، ونظارته لإدارته بما يضمن استمراره وبقائه، وتحصيل غلته، وتوزيعها على مستحقيها... ونحوه.
- 4- قدم الوقف في ليبيا، حيث عرفته البلاد منذ دخول الإسلام إليها حتى وقتنا، وحالها كحال غيرها من الأقطار الإسلامية، مرت بفترات مختلفة من القوة والضعف والنظام والفساد ونحوه، غير أنها في القرن الأخير تعرضت للاحتلال من قبل إيطاليا، ثم لم تلبث وأن تحصلت على استقلالها حتى تعرضت لانقلاب عسكري طال حكمه بالمزاج دون دستور أو رؤية مستقبلية، ما استدعى قيام ثورة شعبية عليه آلت - للأسف - للتسلح، كل هذه العوامل أدت بالوقف إلى الضياع، وعدم الاستقرار، وغياب الرؤية.

- 5- تعرض الأوقاف الليبية لحالات عديدة من الاعتداء والتلاعب، والتزوير، كالتمليك والتخصيص، الأمر الذي أدى إلى عدم الانتفاع بها في تحريك عجلته وتحقيق أهدافه.
- 6- تعتبر أسباب هلاك الوقف وتعطله في ليبيا متعددة، ومتراكمة، منها ضعف توثيقه، والاعتداء عليه بالتمليك والتخصيص، ومنها أيضا الحالة الأمنية التي تعيشها البلاد، واختلاف توجهات الحكومات والأشخاص، كل هذه الأسباب وغيرها أدت بالوقف إلى حالة من الهلاك والتعطل والضعف، وعدم الإيفاء بمقاصده وأهدافه التي وضع من أجلها.
- 7- إمكانية حماية الوقف من أسباب تعرضه للهلاك والتعطل بعدة طرق، منها اللجوء إلى المحاكم لاسترجاع ما تم الاعتداء عليه من أوقاف، والمطالبة ببدلها إن تعذرت إعادتها بعينها، كما يمكن التعامل مع الجهات الأمنية في حالات الاعتداء التي قد تحصل، أيضاً إعادة النظر في النظم واللوائح والقوانين المنظمة للوقف بتقوية مواطن الخلل والضعف فيها، كذلك العمل على تحصيل وثائق الأوقاف وحصريها بتسيير اللجان للمناطق، ورصد المكافآت لذلك، والاستعانة بالمنظومات والأساليب المعاصرة في أرشفة وتسجيل وحصري وتصنيف الأوقاف.
- 8- وضع رؤية مستقبلية بعيدة المدى، وإلزام الحكومات والمسؤولين المتعاقبين بما قانونيا ورقابيا، والنأي بوزارة الأوقاف عن التوجهات المختلفة، من شأنه المساعدة على استقرار الوقف وتطوره.
- 9- فعالية استخدام الوسائل الإعلامية المعاصرة في توعية الناس بجرمة الوقف، ومكانته التاريخية، ورؤيته وتطلعاته المستقبلية، حتى يكون عاملا مساعدا لردع المعتدين دينيا واجتماعيا، ونائبا به عن الصراعات والاعتداءات المتكررة، ودافعا لتنميته وتطويره، وحافزا لمن يتصدى لمهامه ويهتم بشؤونه.

قائمة المصادر والمراجع

القرآن الكريم

- ابن حجر العسقلاني، أحمد بن علي. (1379هـ). فتح الباري شرح صحيح البخاري. بيروت، لبنان: دار المعرفة.
- ابن منظور، محمد بن مكرم بن علي. (1414هـ). لسان العرب. بيروت، لبنان: دار صادر.
- أبو غدة، عبد الستار. شحاته، حسين. (1998م). الأحكام الفقهية والأسس المحاسبية للوقف. الكويت: الأمانة العامة للأوقاف.
- البخاري، محمد بن إسماعيل. (1422هـ). صحيح البخاري. بيروت، لبنان. دار طوق النجاة.
- البيهقي. أحمد بن الحسين بن علي الخراساني. (2003م). السنن الكبرى. بيروت، لبنان: دار الكتب العلمية.
- الترمذي، محمد بن عيسى بن سؤرة بن موسى بن الضحاك. (1998م). سنن الترمذي. بيروت، لبنان: دار الغرب الإسلامي.
- الحاكم، محمد بن عبد الله. (1990م). المستدرک علی الصحیحین. بيروت، لبنان: دار الكتب العلمية.
- دار الإفتاء الليبية. (2017م). فتاوى الوقف. طرابلس، ليبيا: [/https://ifta.ly](https://ifta.ly)
- الدسوقي، محمد بن أحمد بن عرفة المالكي. حاشية الدسوقي على الشرح الكبير. بيروت، لبنان: دار الفكر.
- الزحيلي، وهبة بن مصطفى. الفقه الإسلامي وأدلته. دمشق، سوريا: دار الفكر.
- الشافعي، محمد بن إدريس. (1990م). الأم. بيروت، لبنان: دار المعرفة.
- صحيفة العربي الجديد. (2015م). بالصور.. نهب الوقف الليبي "اهلت" يستتبع الأراضي من عهد القذافي. بنغازي، ليبيا:

- الصلاحيات، سامي محمد. (2017م). أسباب انتهاء الوقف الخيري وكيفية المحافظة عليه. العدد 12. الجزائر: المركز الجامعي لتنامغست. مجلة الاجتهاد للدراسات القانونية والاقتصادية.
- طالبة، مصطفى الصادق. (2014م). نبذة تاريخية عن الأوقاف اللبية وواقعها. طرابلس، ليبيا.
- القحطاني، تركي حسن. (2017م). انتهاء الوقف: مفهومه، أسبابه، حالاته، أحكامه. العدد 1. الشارقة، دولة الإمارات: مجلة جامعة الشارقة للعلوم الشرعية والدراسات الإسلامية. جامعة الشارقة.
- القراي، شهاب الدين أحمد بن إدريس المالكي. (1994م). الذخيرة. بيروت، لبنان: دار الغرب الإسلامي.
- قلعجي، محمد رواس. قنبي، حامد صادق. (1988م). معجم لغة الفقهاء. القاهرة، مصر: دار النفائس للطباعة والنشر.
- الكبيسي، محمد عبيد. (1977م). أحكام الأوقاف في الشريعة الإسلامية. بغداد، العراق: مطبعة الإرشاد.
- مجمع الفقه الإسلامي الدولي. (2004م). قرار رقم 140 (15/6) بشأن الاستثمار في الوقف وفي غلاته وريعه. مسقط، سلطنة عمان: الدورة الخامسة عشر.
- مسلم، أبو الحسن مسلم بن الحجاج النيسابوري. صحيح مسلم. بيروت، لبنان: دار إحياء التراث العربي.
- المواق، محمد بن يوسف الغرناطي المالكي. (1994م). التاج والإكليل لمختصر خليل. بيروت، لبنان: دار الكتب العلمية.
- النفراوي، أحمد بن غانم بن سالم. (1995م). الفواكه الدواني على رسالة ابن أبي زيد القيرواني. بيروت، لبنان: دار الفكر.
- هيئة المحاسبة والمراجعة للمؤسسات المالية الإسلامية (أيوبي). (2019م). معيار الوقف المعدل رقم (60). البحرين: هيئة المحاسبة والمراجعة للمؤسسات المالية الإسلامية.
- ويري، فديريك. (2022م). صراع الفصائل اللبية للسيطرة على الأوقاف الإسلامية. بيروت، لبنان: <https://carnegie-mec.org/2022/01/05/ar-pub-86123>

الإيحاء الذاتي والتربية الاستقلالية وأثرهما على الفرد والمجتمع والمدنية والحضارة في ضوء القرآن الكريم وعلم النفس والاجتماع: دراسة تحليلية تطبيقية⁸¹

Self-suggestion and the Education of Independence and Their Impact on Individual, Society, Urbanism and Civilization in Light of The Quran, Psychology and Sociology: An Applied Analytical Study

محمد بوزينة

طالب دكتوراه في قسم التفسير وعلوم القرآن

highereducationstudent2019@gmail.com

عبد العالي باي زكوب

أستاذ مشارك في قسم القرآن الكريم وعلومه، بجامعة المدينة العالمية بماليزيا

bey.zekkoub@mediu.edu.my

ملخص البحث

إن الإيحاء يحقق السيادة الذاتية والكمال الأخلاقي والحريّة والكرامة الإنسانية ، ولذا حرصت على تنميته و تهذيبه وتفعيله الرسالات السماوية و النبوءات ، لأنه يؤدي الغرض من الإستحقاق و أمانة الإستخلاف ، وهو المحرك النفاث في تفعيل منظومة الإستبصار لدى آدمي ليكتشف ما في الآفاق و الأنفس ، إنّه العقل الواعي ، عقل الاستنتاج والفهم والتقدير والتدبير، ومطيئته إلى الكمال التسيبي الذاتي و المعنوي بحسب استعداداته ، لذلك تتفاوت مدارك الناس ودرجاتهم تفاوتاً عظيماً في القدرة و العجز و العلم و الجهل ، وتنوع آثاؤ هذه الصفات فيهم تنوعاً لا يحده وصف ولا يشمل حصر ، يتبعه اختلاف الأمم في الرقي والتدني و العزة و الذلة ، تبعاً لنموّ العقل و ضروب الإستعداد ، يعقبه تحقق الوجود الذاتي و المعنوي ، عنوان ذلك كله (كرامته فوق كل كرامة و حرّيته لا يستجديها من أحد ، و هو ليس كلاً على أحد ، وأنه لا ينفعه ولا يضره إلا الله ، و هو يعيش في حدود بشرية ، ضعفه و قصوره وقوته) ، يُسمى ذلك كله {التربية الاستقلالية} . إن الإستخفاف و العبودية المختارة ضرب من أخطر ضروب الإيحاء السلبي خصوصاً إذا ما ارتبط بمغلوّ بمفهومي القضاء و القدر جهلاً وسفاهة ؛ إن الإسلام لا يعترف بالزهبانية و البلاهة و الجهل و الغباء و التعالم و الإستسلام السلبي و الإنهزامية و فكر المظلومية، كالمهدية التي تقول بتمني الحلول السحرية السريعة و البرزخية التي تتبنى ثقافة الحمول و سياسة التعويق وانتظار ما تفعله الأفضية و الأقدار فيه لا ما يفعلها هو فيها . إن أهم مبادئ الإيحاء و التربية الاستقلالية {اقرأ} التي تحمل في معناها الخاص و العام أعمال العقل و التفكير في كل ما يجب و ينبغي ، العقل التفسيري لا العقل التبريري المختل و المغلق و المخصي.

الكلمات المفتاحية : الإيحاء الذاتي، التربية الاستقلالية، الفرد والمجتمع، المدنية والحضارة، علم النفس والاجتماع، القرآن الكريم.

ABSTRACT

Positive self-suggestion accomplishes human self-sovereignty, moral perfection, freedom and dignity. That's why divine revelations and prophecies have worked diligently to grow, regulate and activate it, because it accomplishes the purpose of fulfilling the obligation, and the trust of deputization (vice regency). This positive self-suggestion is the jet engine of the activation

⁸¹ بحث مستل من رسالة علمية في برنامج التفسير وعلوم القرآن، قسم القرآن الكريم وعلومه، جامعة المدينة العالمية بماليزيا.

of the system of insight in humans, so they would discover what is inside their own selves and in the horizons of the world around them, this positive auto suggestion represents the conscious minds, the mind of deduction, comprehension, reasoning and management of affairs, It's the means by which humans reach relative self-perfection, as well as symbolic perfection according to man's proclivities or inclinations, Hence people's comprehension and status would vary greatly in capabilities deficiencies, knowledge or ignorance these characteristic would have numerous variations in humans leading to vast differences and effects on human conduct resulting massive differences in different nations in the degree of advancement or backwardness, might or servility according to the thinking advancement and it's different tendencies and proclivities resulting in the realization of self and symbolic existence under the banner of (human dignity is above all types of dignities and human freedom isn't begged from anybody, and a human isn't a burden on anybody and none, but the God could bring man a benefit or harm and he must have within the boundaries of his weakness, strength, and deficiencies), All these things are called (The education of independence). Disparagement of the divine laws of the divine revelations, as well as embracing the chosen servitude to other than God are of the most dangerous types of negative self-suggestion, especially if it's linked erroneously with distorted misunderstanding of the concept of divine preordainments and predestinations resulting in ignorance and foolishness. Islam doesn't recognize stupidity, foolishness, ignorance celibacy like that of the clergy pretension of knowledge, negative surrenderism, defeatism, the principle of victimhood like Mahdism that adopts the Magical out solutions that are fast or otherworldly, which fosters and instills culture of laziness and the creation of a policy of hurdles, hindrances, and obstacles, while waiting for preordainments and predestinations to affect the affairs of man rather than the capabilities of man to affect those preordainments which allegedly control his destiny creating impediments to the mind by this superstition. The most important principles of Positive self-suggestion and of the education of education of independence is the word (read) that was revealed to prophet Muhammad by angel Gabriel at the very beginning of the revelation of the Quran in the cave of (HIRA) near Mecca, As this word (read) has in its general, and specific meaning the education of the utilization of the mind and it's distinctive power of critical thinking To figure out, what ought to be done or avoided and avoided in all situations. We need to adopt the explanatory mind, and not other defective justifying mind that is closed, frozen and castrated.

Keywords: Self-suggestion; the education of independence; individual and society; urbanism and civilization; Psychology and Sociology; The Noble Quran

مقدمة البحث

إنَّ سيطرة رُوح الإِهمامية و الرُّكونَ إلى التَّقليد و التَّبعية المِتمثلة في العقل التَّبريري الاتِّكالي ، مستنقع الوثنية الصَّمنية و شَخصنة المبادئ والأفكار و خلط التَّوابت بالمتغيَّرات و تقديس ما ليس بمقدَّس و السَّطحية و العجز عن التَّأصيل و التَّمحيص ، أي غياب العقل التَّفسيري ، و الميل إلى الإرتجال و الإنشغال بالتَّعبارات و الفصام بين الفكر و العلم و الكسل العقليّ و توهّم التَّعارض بين الدِّين و العقل و العلم ، و حصر العلم بالوحي المنزل و الفصام و التَّنافُض في الشَّخصية ، و عدم وعي العقل بمحدود المتناقضات ، و تفضيل عالم الخيال هُروبًا من الواقع ، و عدم تحديد المفاهيم ، و غياب الموازين ، و التَّفكير الآحادي ، و غياب المعايير الصَّحيحة التي تُعرف بها أقدار الأشياء و قيمتها ، و التَّحيز إلى الدَّات بلا تعقُّل ، و عدم استشعار الواقع كما هو عليه ، و التَّبصُّر و النَّظَر ، و عدم تحرير المصطلحات و المفاهيم و تحديدها ، و استلاب الحرِّية الكرامة ، و الإرهاب الفكريّ و الحرمان من الموادِّ اللازمة لُتموِّ العقل ، و عدم فهم العلم للحياة و التَّلقين بدلًا من الفهم و الاستيعاب ، و الإكتفاء بالسَّطحية و الصَّحالة العلمية و الإلحاح في العبادات و الشَّعائر و الرُّهد في الدُّنيا دون موازنة ، و الفصل بين الفكر و الوجدان ، و الإسراف في التَّقدير الذي المؤدي إلى التَّقديس ، و الإسراف

في الوجدانيات المؤدي إلى الخيال الجامح و الأحلام التي لا يحكمها العقل و لا الشرع ، و الإسراف في الطاعة المؤدي إلى الخضوع غير العاقل ، و الإسراف في الاحتياط المؤدي إلى تعطيل النشاط و الحركة ، و الإسراف في العبادة المؤدي إلى الاعتزال و الرهبانية ، و فقدان التوازن بين القيم، كل أولئك سمة العقل الهزوم المأزوم و تعطيل للإيجاء الإيجابي و تصور في التربية الاستقلالية .

مُشكلة البحث

لقد كثرت المؤلفات في علم النفس و الاجتماع في السنين الأخيرة كثرة هائلة ، فأصبح من العسير على المتصفح البسيط أن يخرج منها بطايل ، ولنستبين كيف أصبح علم النفس و الاجتماع غيابةً و تيهًا ، يُقسَم إلى ثلاثة نماذج : 1_ المؤلفون التجاريون ، وهم كتّاب بضاعتهم الذكاء و إدراك أسرار السوق الأدبية ، فينبأرون سراعًا إلى التلخيص و النقل و الإعلان عن كتب بعنوانين رثانةً ، وهي كتب مشوهة فاسدة ؛ 2_ المؤلفوا الشهرة العلمية و الأدبية وهم من غير جلة علماء النفس و الاجتماع المنقطعين لهما ، و كتب أولئك غزيرة الشروح و النظريات ، وفيها الغث و الجيد ، غير أنه يخالط مادتها تعمد الإغراب في اللفظ و الأداء و التعميق في النظريات الطبية و الاجتماعية، و عباراتها الإصطلاحية بعيدة المنال ، وهذه الكتب لا يخرج منها بشيء غير عالم طويل الأناة وله بصير بالدرس و دراية بالتمحيص، 3_ طائفة العلماء و كتبه هي التي عليها المعول ، عميقة شديدة التركيز قليلة الشروح ، فهم يفترضون في القارئ أن يكون طبيبًا و عالما نفسيًا وأديبًا وفيلسوفًا ومورخًا ، و يقرأ أشهر اللغات الحية ، و منهم من يجعل التطبيق و التمثيل في كتبه بشخصيات الأساطير الإغريقية و التواريخ القديمة المندثرة .

إن انفساح بحر هذا العلم الطامي الذي هو خلاصة الحكمة البشرية منذ قرون على أساس من العلم و المعرفة ، جعلت منه غيابةً تيهًا علميًا بامتياز، يُعيدنا إلى مفهوم التربية المقدس و الإيجاء التي تسبر العلاقة بين الفكر و السلوك الإنساني ، و من خلالها يُكتشف الإيجاء بمفهومه الإيجابي والسلبي، و التربية الاستقلالية بمفهومها الإهزامية المأزومة الإنكالية النفعية، و التربية الإيجابية التي تُخضع النفس للعقل و تُخضع العقل للروح ، و استبانة الجوهر الحقيقي لكل إنسان ، لذا بدأت كل شريعة ب {إقرأ} لتعبر جسر النفس إلى نور العقل ، فمن شروط العقلانية سيادة العقل على النفس ، وهو الفيصل بين الإنسان الفاضل في مواجهة الإنسان الحيوان ، العقل مقابل الغريزة ، و السمو المعرفي مقابل النفعية و الانحطاط و التفسخ . إن اختلال عامل السلوك و الإرادة الإنسانية يؤدي إلى أن تصبح علاقته بالكون و حركته و مكوناته علاقة عذاب و اضطراب و فساد عريض، فهو بهذا التمرد يستهدف وجوده و المركب الذي يُديره بما كسبت يده ، بتعطيل إيجائه الذاتي و الجمعي و التربية الاستقلالية ، التي من أهم ركائزها الحرية و الكرامة الإنسانية ، كل ذلك دفعنا إلى استظهار حُطورة الإيجاء و التربية الاستقلالية على الإنسان و الكون و المكونات .

أهداف البحث

يهدف البحث إلى غاية خطيرة هي استظهار قيمة الإيجاء و التربية الاستقلالية لإنشاء الفرد في مراحل حياته كلها حُرًا كريمًا مستقلاً، تصدُر أعماله وأفكاره عن اختيار و علم لا عن إضطرارٍ و تقليد ، ذلك كله يُعلمك كيف تحكم إرادتك شعورك ، وكيف تُفكر تفكيرًا صحيحًا ، وكيف تسلط عقلك الباطن فيجلب لك سعادتك و نعيمك ، حيث العقل الواعي عقل الاستنتاج و الفهم و التقدير ، فأنت تأخذ بقدر ما تُعطي، لأنك مظهر من مظاهر النشاط الكوني ، لتأدية أكبر نفع للبشرية ، ولا يتأتى ذلك إلا مع الحرية و الكرامة الإنسانية .

أهمية البحث

إنَّ أُمَّةً عُنِيَتْ بِتَرْبِيَةِ أبنائها وتَهْدِيْبِ أخلاقهم وتَنْقِيْبِ عُقُوبهم وإِنْشَائهم أحرارًا عَشاقًا لِلْعِلْمِ والمعرفة ، فأشْرَقَتْ في رُبوعها شمسُهُ ، وكُشِفَ لها الحجابُ عَمَّا سَجَرَ لها من قُوَى الكونِ ، فاستعانت بها على تحسِينِ أحوالها وترقيةِ معاشيها ؛ إِنَّ الدِّينَ أَثْمَرَتْ فيهم التَّربِيَةُ الصَّحِيحَةُ باثُوا يواصلون اللَّيْلَ التَّهَارَ لا يفتُرونَ لتَهْدِيْبِ الشُّدُودِ والعودةِ إلى سَبِيلِ الرِّشَادِ ، غيرَ أَنَّ أُمَّةً أُخْرَى لم تَبْلُغْها دعوةُ العلمِ و لا رأت آتارَ التَّربِيَةِ في غيرها ، فلازمت حالتها الفِطْرِيَّةَ ومعيشتها الوَحْشِيَّةَ ، فكان ذلكَ مدعاةً إلى وقوفِ نَمُوِّ العقلِ في أبنائها وانحناءِ ما فيهم من ضُروبِ الاستعدادِ ، فكان مصيرُها حُسرانَ وُجُودها الدَّائِي وفنائها في غيرها من الأممِ الحَيَّةِ ، فاستحالت حَرِيَّتُها رِقًا وعزُّها ذلًّا وعدُّها ظلمًا و أنسها بالعلمِ وحشةً ، لم يُصَبِّها ذلكَ إلاَّ لِتَفْرِيطِها في حُرِيَّتِها و كرامتها و إغفالها التَّربِيَةَ الصَّحِيحَةَ و هَجْرها العلمَ النَّافِعَ .

منهج البحث

استقرايُّ استنباطيُّ تطبيقيُّ تحليليُّ نقديُّ ، لاستقراءِ آثارِ التَّربِيَةِ الاستقلاليةِ والإيحاءِ الدَّائِي و الجمعي في الأفرادِ والمجتمعاتِ والأممِ والحضاراتِ وحركةِ التاريخِ في ذلك ، ثمَّ هو استنباطيُّ لاستنباطِ الحلولِ وفقِ التَّربِيَةِ القرآنيةِ وتحليلِ المنهجِ من حيثِ الفكرِ الإنسانيِّ بِخُصوصِ الإيحاءِ الدَّائِي و التَّربِيَةِ الاستقلاليةِ وتعليقه وتحليله .

الدراسات السابقة : 1_ كتاب التَّربِيَةِ الاستقلالية⁽⁸²⁾ يرمي مؤلِّفه إلى غايةٍ واحدةٍ ، هي إنشاءُ الفردِ حرًّا مستقلًّا تُصدُرُ أفعاله وأراؤه عن اختيارٍ وعلمٍ ، لا عن جهالةٍ و تعالمٍ اضطراريٍّ و تقليدٍ ، كما أنَّ هذا المؤلِّفَ حَرَجَ عن أساليبِ الكتبِ التَّعليميةِ المعهودةِ ، حيثُ صاغَهُ بأسلوبٍ يقربُ من الأسلوبِ القصصي ليكونَ أهيِّ للنُّفوسِ ، وأنفى للملَلِ عن القُلوبِ ؛ وقسَّمَهُ إلى أربعةِ أقسامٍ ، سَميَ كلاً منها كتابًا ، الأوَّلُ في الأمِّ ، و الثاني في الطِّفْلِ ، والثَّالثُ في اليافعِ ، و الرَّابِعُ في الشَّابِّ ، كلُّ ذلكَ لإِنْشَائهم أحرارًا جامعين بين ملكاتِ العلمِ و الفضائلِ و القيمِ الأخلاقيةِ وهو من المصادرِ القِيَمَةِ في بابهِ .

2_ أسرارُ الإيحاءِ الدَّائِي⁽⁸³⁾ : إنَّ إنفِساسَ بحرِ هذا العلمِ الطَّامِي المترامي في القِدَمِ جعلَ تَبْسيطَهُ و تَهْدِيَةَ في أولوياتِ اهتمامِ الرَّاسخينِ في العلمِ ، و قد عمدَ المؤلِّفُ إلى تَبْسيطِ هذا العلمِ ليخُوضَ مع الحائِضين من أهلِهِ بلغةٍ قَريبَةٍ إلى ذهنِ القارئِ ، وهو تَدْرِيبٌ لِتَمَكِّينِ أكبرِ شريحةٍ من رُوادهِ من الإِستفادَةِ منه ، و إِفْهَامِهِم أَنَّ ما سَيَدْرُسُونَهُ من الأسرارِ و النَّظَرياتِ و التَّدرِيباتِ ، هي خُلاصَةُ الحِكْمَةِ البشريَّةِ منذُ قُرُونٍ ، و تعتمدُ على أساسٍ و طِبْدٍ من العلمِ و المعرفةِ ، حيثُ هو متشعِّبٌ من العلومِ الطَّبيَّةِ و النَّفسيةِ و الأدبيةِ ، و لا يتِمُّ ربطها إلاَّ بالخيالِ السَّلِيمِ و العلمِ الواسعِ ، بعدَ أن أصبحَ علمُ النَّفسِ اليومَ غِيابةً و تِيهًا .

3_ العقلُ الباطنُ⁽⁸⁴⁾ : هذا البحثُ دراسةٌ علميةٌ جديرةٌ ، ورافدٌ قِيَمٍ من روافدِ الدِّراساتِ العلميةِ التي لا زالت مستمرَّةً للكشفِ عن سِرِّ و حَقِيقَةِ القُوَّةِ الخارقةِ التي يَمْتَلِكُها الإنسانُ داخلَ عقلِهِ الباطنِ ، إِنَّهُ يُبَيِّنُ القُوَّةَ الخارقةَ الكامنةَ في أعماقِكَ ، و كيفَ يَمكُنُكَ تسخيرُها علميًّا و معرفيًّا لتجعلَ عقلَكَ الباطنَ يأتي بالمعجزاتِ بِتَوْجِيهِكَ .

82 _ ألفونس إسكروس / التَّربِيَةُ الاستقلاليةُ / ط4

2 _ رمزي مفتاح / أسرارُ الإيحاءِ الدَّائِي / ط1 .

84 _ أحمد توفيق حجازي / العقلُ الباطنُ / ط1.

4_ علم النفس القرآني والتَّهذيبُ الوجداني⁽⁸⁵⁾ : إنَّ العلمَ بحقيقة الإنسان هو مصدرُ قُوَّته ، وحدودُ العلمِ الوُضعي مهما رُحِّبَتْ آفاقُه ، فإنَّه يبقى مزموماً بزمَامِ قَوَانِينِ هِي من وضعِ الإنسانِ نفسه ، و إنَّ القَوَانِينِ هذه مَهْمَا أَحكَمَتْ بَراهِينَهَا ، واستكملتْ استدلالَاتِهَا ، فلنْ تَكُونُ مبنأى عن الشُّلوكِ والرَّيبِ و القُصور . إنَّ الباحثَ جمع خلاصةَ ما لمخ و استقرى و استنبطَ و استخلصَ من عظمةِ علمِ النَّفسِ القرآني ، خلاصةً احتوت في دَفَّتِهَا وعمَّقِهَا على خصائصِ علمِ النَّفسِ الحديثِ، من حيثُ نظريَّاتُه وتجاربُه ومُجَوِّهُه ، كُلُّهَا يتطلَّعُ إلى الإحاطةِ بحقيقةِ بُنيةِ الإنسانِ و مكوِّنَاتِ شَخْصِيَّتِهِ ، و اقترانِ ذلك كُلِّه بوقائعِ علاقَاتِهِ الأخلاقيةِ و الاجتماعيةِ و الحياتيةِ عامَّةٍ.

5 _ خواطرُ الإنسانِ بينَ منظاري علمِ النَّفسِ و القرآن⁽⁸⁶⁾ : إنَّه بحثٌ قيِّمٌ في محاولةِ إزالةِ اللَّبسِ و العُموضِ الَّذي يكتنفُ ماهيةَ العلاقةِ بينَ ماديةِ الإنسانِ وروحانيَّتِهِ ، أسئلةٌ كثيرةٌ في النَّفسِ وأقسامِهَا و آفاقِهَا ووظائفِهَا ، أينَ يَكُونُ عندَ النَّومِ و بعدَ الموتِ ؟ ، ما علاقةُ ذلكَ بالجسدِ ؟ ، هذا اللُّغزُ الكبيرُ كيفَ تتعاملُ معه ؟ ، حاولَ الباحثُ الإجابةَ عنها بطريقةٍ مختصرةٍ ، وهي من جُملةِ أسئلةٍ كثيرةٍ أَرَقَّتْ أساطينَ الفكرِ و الفلسفةِ في العصورِ الغابرةِ ، وأساطينَ العلمِ و المعرفةِ و البحثِ في العصرِ الحديثِ ، كيفَ تناولوها ؟ ، و كيفَ أجابوا عنها ، وما صحيحُ هذه الإجاباتِ كُلِّهَا ؟.

6 _ هذه هي الأغلالُ / الإسلامُ والحضارةُ الإنسانيةُ⁽⁸⁷⁾ : هذا الكتابُ بحقٍّ ثورةٌ في فهمِ العقليِّ و الدِّينِ و الحياةِ باليقينِ و الثُّرهانِ ، لأنَّه حربٌ على سُلطانِ الجهلِ و العادةِ و جحافلِ الغوغاءِ و أشباههم ، وأسائِدِ البلاهةِ و من يُوجِبونَ على النَّاسِ التَّكاسلَ باسمِ الإتيكالِ على الله ، ويوهنونَ ثقةَ الإنسانِ بنفسِهِ بمغلوطينِ مفهومِ القضاءِ و القدرِ ، ويُنكرونَ الحكمةَ القديمةَ و العلمَ الحديثَ ، و قد استندَ في كثيرٍ من معارضِ التَّقديدِ على آياتٍ من التَّنزيلِ العزيزِ ، و أمثلةٍ من سيرِ الأنبياءِ ، وأسائِدِ من المنطقِ السَّلِيمِ ، هاجمَ أناسًا يُجسِّبونَ عندَ العامَّةِ وأشباهَ العامَّةِ من العُلَماءِ المتقدِّمينَ ، ودَبَّ عن فلاسفةٍ غيرِ مُسلمينَ لم يشهدوا عهدَ الأديانِ ، وأنكرَ على من يمتدحونَ الجنونَ والبلةَ ؛ نخالُفه في بعضِ الأفكارِ الَّتِي تحتاجُ إلى الموازنةِ و التَّحقيقِ في معنى (الْقصدِ الحيويِّ)، إنَّ الإفراطَ في العنايةِ بالرُّوحيةِ صنوُ الإفراطِ في الماديةِ و العنايةِ الجسديةِ ، إنَّه مرجعٌ قيِّمٌ في فهمِ معنى الإيحاءِ و التَّربيةِ الإستقلاليةِ و تأصيلِهَا .

• الخاتمةُ مع النتائجِ : إنَّه إذا كانَ هذا هو شأنُ التَّربيةِ في هُوضِ الأممِ و انخيارِهَا ، كانَ حقًّا على العقلاءِ من كلِّ أُمَّةٍ أنْ يُعنوا بِهَا ، و يُفكِّروا في الوصولِ إليها من أقومِ طُرُقِهَا ، و يُبيِّنوا أوصولَها و يُدوِّنوا فيها الكتبَ النَّافعةَ ، و يَحْتُوا أقوامَهُمْ على الأخذِ بِأحسنِهَا ، و يتعهَّدوا أنفُسَهُمْ بتربيتها و تقييمِ أخلاقِهَا و تنميتها ملكاتِهَا ، ولا يتأتى ذلكَ إلَّا بسعةِ الإدراكِ و الإهتمامِ بما يُرشدُ إليه العقلُ من نتائجِ التَّفكيرِ في مدلولَاتِهَا ، و الرَّجوعُ إلى هَدْيِ النَّبِيِّينَ و وَحْيِ المرسلينَ فيما يَعجزُ العقلُ عن إدراكِ كُنْهِهِ ، لخروجهِ عن مُتناولِهِمْ ضنًّا بِنفسِهِمْ أنْ يستبدَّ بِهَا الهوى فتردى ، وبعقولِهِمْ أنْ يعتسِفَ فتشقى ، و من أفضلِ الوسائلِ الموصلةِ إلى هذا الغرضِ النَّبيلِ: 1_ مدارسُ القرآنِ الكريمِ و تفهيمُهُ روحًا ومعنى و تطبيقُهُ تصورًا و منهجًا وسلوكًا ، و متابعَةُ سيرِ النَّبِيِّينَ و المرسلينَ و الخلفاءِ الرَّاشدينَ و من بعدهم من الأئمَّةِ المجتهدينَ ، و عقلاءِ الأُممِ و سُرَواتِ النَّاسِ من الأوَّلِينَ و الآخرينَ ، 2_ النَّظَرُ في مختلفِ علومِ الثُّراثِ و الفكرِ الحديثِ في علمِ التَّربيةِ و الإيحاءِ ، و الأخذُ بأحسنِ ما كُتِبَ فيها و أفرِه إلى الدِّينِ ، و بثُّه في العالمينَ ليروضوا أنفُسَهُمْ عليه ، و يقوِّموا ما اعوجَّ من أخلاقِهِمْ فثُحمدَ فيهِم آثاره.

85 _ عبد العلي الجسماني / علم النفس القرآني و التَّهذيبُ الوجداني / ط 1 .

86 _ وليد عبد الله زريق / خواطرُ الإنسانِ بينَ منظاري علمِ النَّفسِ و القرآن / ط 1.

87 _ القصيمي عبد الله / هذه هي الأغلالُ ، الإسلامُ و الحضارةُ الإنسانيةُ / (ط 2) .

الإيحاء الذاتي والتربية الاستقلالية وأثرهما على الفرد والمجتمع والمدنية والحضارة في ضوء القرآن الكريم وعلم النفس و الاجتماع. وفيه مبحث، و ينقسم إلى ستة مطالب.

المبحث : الإيحاء الذاتي و التربية الاستقلالية ، تعريفهما ، أثرهما على الفرد و المجتمع و المدنية و الحضارة.

المطلب الأول _ الإيحاء الذاتي و التربية الاستقلالية ، تعريفهما و أبعادهما و أثرهما في الأزمنة و الأمكنة و الأشخاص.

الحمد لله الذي علم بالقلم علم الإنسان ما لم يعلم ، و الصلاة و السلام على نبي الرحمة P. إن الإيحاء الذاتي (88) و التربية الاستقلالية يرجعان إلى الرسالات السماوية حيث عقيدة التوحيد محيكة النفاث ، فقد استعمله الهندوس القدماء كواسطة لتحقيق الكمال الأخلاقي ، و انتشرت هذه الطريقة في الإيحاء الذاتي ، والتي هي التأثير على ذات الشخص عمدا باستعمال الصور الذهنية لدى الكلدانيين في بلاد الرافدين وسوريا ومصر واليونان ، و لاقت اهتماما كبيرا من الفلاسفة اليونانيين ، و بذلك انتقلت إلى الأخلاقيين اللاتنيين ، وفي أوائل القرن التاسع عشر قام كل من د. كروست لا غروند ود. إميل كويه بتطوير المعرفة بتفعيل الإيحاء الذاتي و الجماعي ، و كان هؤلاء سابقين للأسس العلمية التي أوجدها د. جيمس برايد الذي أكد طبيعة التنويم المغناطيسي السيكولوجية ؛ إنه يحقق السيادة الذاتية النسبية ، وهو الوسيلة التي بواسطتها يمكن للإنسان إراديا تغذية عقله الباطن بأفكار من طبيعة خلافية ، أو أنه يسمح له أن يتغذى على الأفكار ذات طبيعة هدامية ، كما يستطيع عقل الإنسان المحدود الاتصال مباشرة بالقوة اللاهائية (89) ، إنه يعلمك كيف تحكم إرادتك شعورك ، و كيف تفكر تفكيرا صحيحا ، فيجلب لك سعادتك و نعيمك ، العقل الواعي هو عقل الاستنتاج و الفهم و التقدير (90)

فقد مضت سنة الله في الإنسان أن يخلق عاجزا جاهلا محتاجا إلى الكافل الذي يحوطه بعنايته ، و يقيمه على الصراط السوي في معيشته ، ثم يتدرج في القدرة و العلم حتى يبلغ ما أعد له من الكمال الحسي و المعنوي بحسب استعداده ، و على مقدار قيمته بتربيته ، من أجل هذا تفاوتت درجات الناس تفاوتا عظيما في القدرة و العجز و العلم و الجهل ، و تنوعت آثار هذه الصفات فيهم تنوعا لا يحده وصف ولا يشملهم حصر ، و تبع ذلك اختلاف الأمم بالتقوي و التذلي والعزة والذلة ؛ فمن أمة غنيت بتربية أبنائها و تهذيب أخلاقهم و تنقيف عقولهم وإنشائهم أحرارا عشاقا للعلم ، فأشرقت في رُبوعها شمسها ، و كُشف لها الحجاب عما سُحّر لها من قوى الكون ، فاستعانت بما في تحسين أحوالها و ترفيه معاشها (91) ، غير أن أمة أخرى لم تبلغها دعوة العلم و لا رأت آثار التربية في غيرها ، فلأزمت حالتها الفطرية و معيشتها الوحشية ، فكان ذلك مدعاة إلى وقوف نمّو العقل في أبنائها و انحاء ما فيهم من ضروب الاستعداد ، و كان مصيرها خسران و جودها الذاتي و فنائها في غيرها من الأمم الحية في (عبودية مختارة) ؛ و أمة ثالثة خلقت مستعدة للتقوي و سارت في سبيله بعيدا ، بما نشأت عليه من الحرية ، و ارتاضت به من أصول التربية الدينية الصحيحة ، فنالت في الزمن اليسير من العزة و المجد و بسطة السلطان ما لم ينله غيرها من الأمم في زمن طويل (92) ، فلم يدعوا بابا في العلم إلا اقتحموه على ما كانوا يلاقونه من صعوبة التحصيل لندرة الكتب و تباعد معاهد التعليم ، يشهد لهم بذلك ما خلفوه من تراث عظيم في أفانين العلوم كلها ما يوجب لأتباعهم حق المفاخرة بهم ؛ فلما طال عليها الأمد ، فسدت الأخلاق

88 _ أحمد توفيق / الإيحاء العقلي / (ط1) ص 59.

89 _ المصدر نفسه / (ط1) ص 64.

90 _ رمزي مفتاح / أسرار الإيحاء الذاتي / (ط1).

91 _ ألفونس إسكروس ، التربية الاستقلالية (ط1) ، ص 5 .

92 _ المصدر نفسه / (ط1) ص 6 .

و استحكمت علّة الرّف في النفوس ، وتملكها الطّمع وتولّأها الحسد ، ومُنبت بحكّام مستبدين وأمرأء فاسدين غاشمين ، فمزّقوا قشرها الحصين و ملكوا عليها أمرها و صرّفوها فيما تهوى أنفُسهم ، استحالت حرّيتها رقاً ، و انقلب عُرّها ذلاً ، وعدّها ظلماً وأنسها بالعلم وحشة ، لم يصبها ذلك إلا من تفرّطها في حرّيتها و إغفالها التّربية الصّحيحة و هجرها العلم النّافع⁽⁹³⁾ .
يقول عبد الله القصيمي: ' إِنَّ لِلّوهِمِ الْوَاحِدِ فِي الْحَيَاةِ ثَلَاثُ نَتَائِجٍ ، أَوْلَاهَا : أَنْ يَعُوقَ عَنِ السَّيْرِ إِلَى الْغَايَةِ الْمَنْشُودَةِ ، ثَانِيهَا : أَنْ يُوَجِّهَ وَجْهَهُ أُخْرَى مُضَادَّةً ، وَهَذَا فِيهِ الْإِبْعَادُ عَنِ الْغَايَةِ ، وَضِيَاعُ الْجَهْدِ الْمَبْدُولِ سُدى ، ثَالِثُهَا : إِفْسَادُ الْعَقْلِ ، فَإِنَّ الْأَوْهَامَ تَأْكُلُ الْعُقُولَ ، وَكُلُّ وَهْمٍ يَأْخُذُ مِنَ الْعَقْلِ بِقَدْرِهِ ، وَلَا تَزَالُ الْأَوْهَامُ تَتَوَالَى عَلَيْهِ حَتَّى يُصْبِحَ عَاجِزاً عَنِ التَّمْيِيزِ وَيَتَخَلَّى فِي النَّهَايَةِ عَنِ وظيفته' ،⁽⁹⁴⁾ .

"إِنَّ أَسْوَالَ التَّرْبِيَةِ الْحَدِيثَةِ الْمَوْضُوعَةَ بِإِرْشَادِ عِلْمِ النَّفْسِ وَ الْإِسْتِقْرَاءِ لِلْأَمْدِ الطَّوِيلِ ، قَائِمَةٌ الْيَوْمَ عَلَى تَعْظِيمِ شَأْنِ { الْإِيْحَاءِ الدَّائِي } وَ الْعَمَلِ بِهِ ، أَي عَلَى إِفْهَامِ كُلِّ إِنْسَانٍ أَنَّهُ قَوِيٌّ قَادِرٌ عَلَى مَا يُرَادُ مِنْهُ عَمَلُهُ ، وَأَنَّهُ يَسْتَطِيعُ أَنْ يَأْتِيَ مِنَ الْأَعْمَالِ بِالْمُعْجَزَاتِ وَ الْخَوَارِقِ ، وَإِنَّ مَعِينَ قَدْرَتِهِ لَا يُمْكِنُ أَنْ يُنْضَبَ ، وَإِنَّ سُلْطَانَ هَذِهِ الْقَدْرَةِ لَا حُدُودَ لَهُ ، وَإِنَّ مَا يُمْكِنُ أَنْ يُدْعَى مِنَ الْأَعْمَالِ "إِذَا أَحْسَنَ اسْتِخْدَامَ مَوَاهِبِهِ وَأَحْسَنَ شَحْذَهَا" لَا يَقِفُ عِنْدَ غَايَةٍ وَلَا يَعْجُزُ عَنِ بُلُوغِ نَهَايَةٍ ، وَعَلَى إِفْهَامِهِ أَنَّهُ خُلِقَ مَعْدّاً مَهِيئاً لِأَنْ يَتَغَلَّبَ عَلَى كُلِّ شَيْءٍ ، وَأَنْ يَصَارِعَ كُلَّ مَا يَقِفُ فِي طَرِيقِهِ ، وَأَنْ يَسْمُوَ حَتَّى يَلْحَقَ الْخَيَالَ لَا بَلَّ وَ يَسْبِقُهُ .. ، وَعَلَى إِفْهَامِهِ الْاسْتِقْلَالَ فِي الْعَمَلِ ، وَعَلَى أَنَّهُ وَاجِبٌ عَلَيْهِ أَنْ يَصْنَعَ كُلَّ مَا هُوَ مَحْتَاجٌ إِلَيْهِ وَحْدَهُ دُونَ عَوْنٍ وَدُونَ رِعَايَةٍ ، وَأَنَّ قَدْرَتَهُ صَالِحَةٌ لِذَلِكَ جَدِيدَةٌ بِهِ أَهْلٌ لَهُ⁽⁹⁵⁾ ؛ إِنَّ كِرَامَتَهُ فَوْقَ كُلِّ كِرَامَةٍ ، وَحَرِيَّتَهُ لَا يَسْتَجْدِيهَا مِنْ أَحَدٍ ، وَهُوَ لَيْسَ كَلّاً عَلَى أَحَدٍ ، وَأَنَّهُ لَا يَنْفَعُهُ وَلَا يَضُرُّهُ إِلَّا اللَّهُ ، وَلَا يَعْطِيهِ وَلَا يَمْنَعُهُ إِلَّا اللَّهُ ، وَأَنَّ الْإِنْسَانَ مَهْمَا عَلَا شَأْنُهُ فَلَنْ يَتَعَدَى حُدُودَ بَشَرِيَّتِهِ ، يَعِيشُ فِي حُدُودِهَا قُوَّتَهُ وَضَعْفَهُ وَفُضُورَهُ ، وَهَذَا مَا يُسَمَوْنَهُ [التَّرْبِيَةَ الْاسْتِقْلَالِيَّةَ] ، وَهِيَ أَعْظَمُ تَرْبِيَةٍ ، وَالْأُمَّةُ الَّتِي تَصَلُّ إِلَيْهَا وَتَقْدِرُ عَلَيْهَا تَضْحَى أَعْظَمَ أُمَّةٍ وَ أَقْوَى وَ أَشَدُّ مَنَعَةً ، وَقَدْ ثَبَتَ أَنَّ الشَّعْبَ الَّذِي يُمْكِنُ إِقْنَاعُهُ بِأَسْلُوبٍ صَحِيحٍ بِمَقْدَرَتِهِ وَكِفَايَتِهِ لِأَنْ يَنْتَجِ وَيَتَكَّرَ وَيَسُودَ ، وَأَنَّهُ يَسْتَطِيعُ أَنْ يَتَدَرَّعَ مِنْ مَوَاهِبِ الْخَاصَةِ وَقَوَاهِ النَّفْسِيَةِ مَا يَرِدُ بِهِ عَلَى كُلِّ عَدُوَانٍ ، وَ يَكْبِخُ بِهِ جَمَاحَ كُلِّ مُتَطَوِّلٍ ، مِثْلُ هَذَا الشَّعْبِ مِنَ الْعَسِيرِ أَنْ يَهُونَ ، وَ أَنْ يَذَلَّ وَأَنْ يَجِيءَ مُتَأَخِّراً فِي مَرَاتِبِ السَّبَاقِ الْعَالَمِيِّ ، أَوْ أَنْ يَعْجِزَ عَنِ صُعُودِ قَمَّةِ الْأَهْدَافِ الْإِنْسَانِيَّةِ الْعَلِيَا ، أَوْ يَقِفَ دُونَ أَمَلٍ مِنْ آمَالِهِ الْكَبِيرَةِ ، كَمَا ثَبَتَ أَنَّ الشَّعْبَ الَّذِي يُمْكِنُ إِقْنَاعُهُ بِعَجْزِهِ وَضَعْفِهِ وَهَوَانِهِ ، وَأَنَّهُ لَيْسَ أَهْلاً لِشَيْءٍ وَلَا جَدِيداً بِشَيْءٍ ، وَأَنَّهُ مَجْرَدٌ مِنْ كُلِّ الْقُوَى الَّتِي يُمْكِنُ اسْتِخْدَامُهَا فِي إِدْرَاكِ مَا يَرَادُ إِدْرَاكُهُ ، وَأَنَّهُ أَيْنَمَا يُوَجِّهُ لَا يَأْتِي بِخَيْرٍ مِنْ قَبْلِ ذَاتِهِ وَمِنْ اسْتِعْدَادِ نَفْسِهِ ، ثَبَتَ أَنَّ هَذَا الشَّعْبَ لَا يُمْكِنُ أَنْ يُنْتَظَرَ مِنْهُ سِوَى الْإِسْتِسْلَامِ⁽⁹⁶⁾ بِكُلِّ مَا يَفَاجَأُ بِهِ الزَّمَانُ وَتَأْتِي بِهِ الْحَيَاةُ مِنَ أَلْوَانِ الْهَوَانِ ، وَأَنْ يَكُونَ كَلّاً عَلَى الْإِنْسَانِيَّةِ فِي مَرَاكِهَا كُلِّهَا لَا يَنْفَعُ وَلَا يَنْتَفِعُ بِهِ ، كَوْنُ هَذِهِ الشُّعُوبِ تَجْهَلُ سِرَّ هَذِهِ الْقَدْرَةِ وَسِرَّ الْإِيْحَاءِ بِهَا وَ الْإِيْحَاءِ وَسِرَّ الْيَقَّةِ الْمَطْلُوقَةِ بِالنَّفْسِ ؛ لَقَدْ قَامَ الْبِرْهَانُ عَلَى أَنَّ أَعْظَمَ مَا يُمْكِنُ أَنْ يَقْدِمَهُ التَّنَوُّمُ بِالْإِيْحَاءِ لِلْبَشَرِ مِنْ فَائِدَةٍ هُوَ اسْتِخْدَامُ هَذَا الْإِيْحَاءِ فِي شِفَاءِ الْأَمْرَاضِ أَوْ تَخْفِيفِهَا ، وَفِي حِلِّ الْعُقْدِ النَّفْسِيَةِ الْمُسْتَعْصِي عَلَى الطَّبِّ عِلَاجُهَا ، كَمَا ثَبَتَ أَنَّ لِهَذَا الْإِيْحَاءِ قُوَّةً تَكَادُ تَكُونُ جَدِيدَةً فِي عِلَاجِ ضُرُوبٍ كَثِيرَةٍ مِمَّا تَعَانِي الْإِنْسَانِيَّةُ وَتَشْكُو ، فَالْإِيْحَاءُ بِالنَّفْسِ وَبِقَدْرَتِهَا هُوَ أَصْلُ التَّرْبِيَةِ الصَّحِيحَةِ الْقَوْمِيَّةِ ، وَأَوَّلُ السَّيْرِ فِي طَرِيقِ إِزَاحَةِ الْأَغْلَالِ كُلِّهَا وَعَلَى رَأْسِهَا الْاسْتِبْدَادُ وَ الْاسْتِعْبَادُ وَ الْإِذْلَالُ ، كَمَا أَنَّ الْكُفْرَ بِالنَّفْسِ وَبِكِفَايَتِهَا وَ اسْتِعْدَادِهَا بِوَدِّي لَا مَحَالَةَ إِلَى الدَّمَارِ وَ التَّخْلُفِ وَرُكُوبِ الدُّلِّ وَ الْهَوَانِ وَ الْإِنْخِلَالِ ، [فَالْتَّعَالِيمُ قَائِمَةٌ عَلَى أَنَّ الْإِنْسَانَ خُلِقَ عَاجِزاً مَجْرَداً مِنْ كُلِّ قُوَّةٍ ، عَاجِزاً عَنِ أَنْ يَعْمَلَ شَيْئاً ، وَإِنَّمَا هُوَ ظَرْفٌ وَمَحَلٌّ لِلْإِعْمَالِ ، كَمَا

93 _ المصدر نفسه / (ط) ص 7 .

13 _ القصيمي عبد الله / هذه هي الأغلال / (ط) ص 5.

14 _ القصيمي عبد الله / هذه هي الأغلال (ط) ص 255 .

15 _ القصيمي عبد (الله) / هذه هي الأغلال / (ط) ، ص 257 .

يزعم كثيرٌ على فهمٍ قاصرٍ للقضاء و القدر ، هي تعاليمٌ زائفةٌ مقوّضةٌ مُهلكةٌ لمن يسلكُ سبيلها، وليس من الممكن أبداً أن تجد أمةً تدينُ اللهَ بهذه التعاليم ، فتترنحَ عنها لباسَ الاستبدادِ و الاستعبادِ و الدُّلّ و الهوانِ المضروبِ عليها خيمةً ، فما القضاء و القدرُ عند من رَضُوا بالدُّلّ و الاستعبادِ و الاستبدادِ ، إلاّ الإذعانُ و الاستسلامُ زاعمينَ أنه مما يوجبهُ الإيمانُ بما؟!.

المطلب الثاني: الإيحاء الذاتي و التربية الإستقلالية و المفهوم الخاطئ للقضاء و القدر وآفة الجهل و التعالم.

يقولون : إنّ القضاء و القدر يُفهمُ عندهم كالتالي: ①- إنّ الله قد سجّل على الإنسان منذ الأزل كلّ أعماله، وربطه بها ربطاً لا انفكاكُ منه ، بحيث لا يجدي معه الإرشادُ ولا النصْحُ ولا محاولةُ الخروج ، ②- إنّ الله أوجدَ في الإنسان الذي يعمل الشرَّ الاستعدادَ للشرِّ في أصلِ خلقته وطبيعته دون الذي يعملُ الخيرَ، فإنّ الله خلق فيه الاستعدادَ للخير دون الاستعدادِ للشرِّ، فرّق بينهما في أصلِ الخلقة و الطبيعة ، فلا يستطيع المرءُ الخروجَ عما خلُق مستعداً له ، ③- إنّ الله أرصدَ بطرقٍ خفيةٍ غامضةٍ في سبيلِ كلّ إنسانٍ ما يوجّههُ بالقوةِ إلى الأعمال التي يعملها، أو التي تظهرُ عليه بأسبابٍ خفيةٍ ودون الخفيةِ ، ④- إنّ الإنسان الذي يريدُ الخيرَ أو الشرَّ لا يريد شيئاً منهما بنفسه وإنما الله الغالبُ ، هو الذي يخلقُ إحدى الإرادتين فيه لأسبابٍ غيرِ معلومةٍ ، أو لأنّه يريد أن يُضللَ بعضَ النَّاسِ ويُشقيهم ليكونوا وقودَ النَّارِ بمجردَ أنّه قادرٌ خالقٌ!!، فخلقُ هذه الإرادةِ الشريرةِ في نفس الإنسان، يعني أنّه لن يفعلَ غيرَ الشرِّ مطلقاً، فهو شرٌّ بالخلقةِ إلى الأبد، ⑤- إنّ الإنسان ليس عاملاً ولا فاعلاً في الحقيقة ، وليست له القدرةُ على العمل ، بل على أيّ شيءٍ ما!!، و ليس له فيها غيرُ المحلّةِ ؛ وعندهم أنّه من اعتقد أنّ الإنسانَ موجدٌ أعماله حقيقةً فهو مشرّكٌ!!، لأنّه اعتقد أنّ مع الله موجدٌ آخر، فالإيجادُ عندهم هو الخلقُ ، فهذا هو فهمهم للقضاء و القدر الذي عبّدوا به ملايين النَّاسِ في شرقِ الأرضِ وغربها للسلّاطين و الطغاةِ المستبدين و المستعمرين، وجعلوا منهم كلاً على الغرب المتصهين وحضارته حتى الشوكة و المعلقة و الحذاء .

انتشرت هذه المذاهب انتشاراً عجيباً بكلِّ طاماتها ، وفرضت حصاراً لا يمكنُ الخروجَ منه أو الإفلات ، ومحاولةُ ذلك يعني محاولةُ الخروجِ من الإسلام ! ومن القضاء و القدر!!، حيثُ هما ركنانِ من أركانِ الدّين، فكانت العاقبةُ أن رَضُوا بالاستسلامِ وراضوا أنفسهم عليه ، حتّى أصبحَ فيهم طبيعةٌ وسجيةٌ ، استسلموا وجمدوا تحت رحمةِ الأقدارِ و الأفضيةِ حسبَ فهمهم لها ، وإن أصابهم شرٌّ وهوانٌ ضرعوا له واستسلموا وقالوا : إنّما هي فعلةُ الأقدارِ، وإنّ الله هو الفاعلُ الضّائرُ النَّافعُ ، [الحقُّ الذي يراؤُ به باطلٌ] .الم يكن وجودُ آفةِ الطغيانِ و الاستبدادِ و الإعتسافِ يوماً مانعاً من الخلاصِ منه ، إلاّ إذا كان وجودُ الفقرِ و المرضِ وغيره من الآفاتِ و النَّفائصِ مانعاً الخلاصِ منها ، أو محرّماً على قولِ الاستسلامِ و الاستخفافِ و العبوديةِ المختارةِ ؛ يجبُ أن نعتقد أنّ تسلّطَ الطغاةِ و المستبدين على المجتمعات ، هو بمثابة العقوبةِ الجماعيةِ جزاءً تركِ واجبٍ محرّمٍ ، [الأمرُ بالمعروفِ و النهي عن المنكر] ، فالعقوباتُ من حيثُ هي يجبُ أن تُؤدّي إلى الإصلاحِ و التّطهيرِ والإقلاعِ و النزوعِ عن أسبابِ العقوبةِ القاسيةِ ، ولا تكون العقوبةُ لدوامِ العقوبةِ أو سبباً في بقاءِ الجريمةِ ، كما لا يكونُ الاستبدادُ و الطغيانُ و الاستكبارُ مؤدّياً إلى دوامِ أسبابه أو تكرارها ، فليس أبداً الطغيانُ و الاستبدادُ قدرًا مقدوراً⁽⁹⁷⁾ . يقولون: "إنّ الرّزقَ مقسومٌ أزلاً، لا تبدلُ ولا تتغيّرُ قِسْمَتُهُ"⁽⁹⁸⁾!!!، فأبي فائدةٍ هي إذا في السّعي و الإهتمام و الطّلب ، إلاّ الدُّلّ و الهوانُ في الدُّنيا و الثبُتُ و الخسرانُ في الأخرى؟!، ويقولون : "ما فُدرَ لماضيك أن يمضغاهُ فلا يمكنُ أن يمضغهُ غيرُك" ، وصارَ القضاءُ و القدرُ هما المددُ الذي لا ينقطعُ لتغذيةِ هذه الأدواءِ وجرائمهها، حتى صارت لازمةً أينما نُولي وجهك فتمّ من يعرّذُ بها، إنّما هو [القضاءُ و القدرُ]، فإذا ناديت في جُموعِ المسلمين منكرًا عليهم ذلّتْهم عبوديتهم وهوانهم واختصاصهم بما دون العالمين، أجابوا سجيّةً "إنّ القضاءُ و القدرُ"، سلّ من شئت في أيّ جزئيةٍ من جزئياتِ حياته فسيكونُ

16 _ القصيمي عبد (الله) / هذه هي الأغلال / (2ط) ، ص 261.

17 _ الغزالي أبو حامد/ الإقتصاد في الاعتقاد/ دار أفنان "دمشق سورية"تحقيق علاء الدّين الحموي"(1ط) 1419-1999م

جوابه ، "إنه القضاء و القدر"⁽⁹⁹⁾، هنا العذر الواضح المقبول، وهو السبب الظاهر المعقول، في كل فشل وهوانٍ وعبوديةٍ وعجزٍ وفقرٍ ويؤس؛ شعوبٌ ظلت لقرونٍ تُعلمُ وتُراضُ على أنها ليست لها قدرةٌ ولا فعلٌ]، وإنه ليس في الإيمان أن تكون كذلك ، لأنَّ الفعلَ والقدرةَ من صفاتِ الله التي لا ينازعها فيها إلا الكافرون ، وظلَّ الاعتقادُ السائدُ أنَّه الإيمانُ الذي يجبُ أن تتعبَّدَ الله به !!! ، وأيُّ مخالفةٍ له ضلالٌ مبينٌ ، لقد ظلت هذه التعاليمُ تُلقنُ لقرونٍ طويلةٍ ، إنَّ شعوبًا كانت هذه تربيتهما أني يُرجى لها غيرُ ما أصابها؟! ، وأني يُرجى منها غيرُ ما هي فيه من الضنوبِ والهبوطِ؟! .

إنَّ نتيجةَ الإيمانِ بالقضاءِ والقدرِ أن تكون صلاتُ الإنسانِ باللهِ و الإنسانِ بنفسه وبالخليقةِ كلِّها، صلاتٌ سليمةٌ تُدللُ على العقلِ و الفكرِ النَّاضجِ ، ولو أنَّ الإنسانَ عقلٌ أن لكلِّ شيءٍ قدرًا لا يتعداهُ وسنةٌ لا يفلتُ منها ، وناموسًا ليس بالمستطاعِ الخروجُ من قبضتهِ ، ثمَّ عقلٌ أنَّ الله قد فرغَ من هذه السننِ و التواميسِ و الأقدارِ، وأنَّه قد طويتِ الصُّحفُ وجفتِ الأفلامُ ، وأنَّه ليسَ من الممكنِ أن يجابي أو يرشُو ويتملِّقَ أو يُدهنَ، لو أنَّه عقلٌ هذا كلُّه ، لكان اتجاهه في الحياةِ وخطواته في الطريقِ أقربَ إلى الهدى وأبعدَ عن العثارِ و الرُّلُلِ؛ إنَّ الأممِ التي لا تُؤمنُ بالقضاءِ والقدرِ بمعينيهما الصَّحيحينِ ؛ أممٌ لا يمكنُ أن تُحسنَ في حياتها سوى التَّخبطُ و الفوضى و الارتباكُ في جميعِ شؤونِ الحياةِ ، ومن أجلِ هذا كلِّه ، ومن أجلِ حُسنِ السَّيرِ إلى الله و التَّرفي في الكمالِ ، كانَ الإيمانُ بجمَا من أركانِ الدِّينِ ، وكانَ شأهُما من الإيمانِ عظيمًا ، " فالإيمانُ بجمَا أولى خطواتِ الأُمَّةِ في مدارجِ الكمالِ ومعارجِ السُّموِّ العقليِّ و الماديِّ "⁽¹⁰⁰⁾.

إنَّ لكلِّ أُمَّةٍ جهنَّتها ومُتخلِّفوها ونسبتهم إلى أهلِ العلمِ في أيِّ مجتمعٍ من المجتمعاتِ عاليةٌ جدًّا ، والدُّولُ المتحضِّرةُ تحرصُ على انتشارِ هؤلاءٍ من هذا المستنقعِ الآسنِ ، لأنَّ الأُمَّةَ الجاهلةَ لا يُعبأُ بها بين الأممِ ، إنَّ الجاهلَ المتخلِّفَ لا يضعُ الشيءَ في محلهِ ، وكثيرًا ما تصدرُ عنه الحماقةُ التي منها يتولَّدُ التَّهوُّرُ وسوءُ التَّصرُّفِ و الضَّعفُ وسرعةُ الغضبِ و الإنفعالُ وسوءُ السُّلوكِ ، وسرعانَ ما يقعُ في الخطأِ و التَّردِّي و السُّقوطِ ، جاءَ عن النَّبيِّ مُحَمَّدٍ (ﷺ) : «من يرد الله به خيرًا يفقهه في الدِّينِ»⁽¹⁰¹⁾، وعن أبي ذرِّ الغفاري رضي الله عنه قال: العالمُ والمتعلِّمُ شريكان في الخيرِ ، وسائرُ النَّاسِ لا خيرَ فيهمِ ، كن عالمًا أو متعلِّمًا أو مستمعًا ، ولا تكن الرَّابعَ فتهلك،⁽¹⁰²⁾ ، يريدُ به الجاهلُ ؛ إنَّ الجهلَ إذا حلَّ بأُمَّةٍ من الأممِ فتكَّ بها ، فكان مصيرُها الهلاكُ و البوارُ، وبذلك تكونُ عُرضةً لإفتراسِ الأعداءِ ، إنَّ النَّبيَّ (ﷺ) فرضَ على أُمَّتهِ طلبَ العلمِ ، فعن أنسِ بن مالكٍ رضي الله عنه عن النَّبيِّ (ﷺ) أنَّه قال: «طلبُ العلمِ فريضةٌ على كلِّ مسلمٍ»⁽¹⁰³⁾؛ فأوَّلُ التَّنزيلِ ﴿ أَقْرَأْ ﴾ ، طلبُ العلمِ و القراءةُ والتَّعلمُ بجميعِ درجاته وتخصُّصاته كلُّ ذلك فرضٌ عينٌ على المسلمِ العاقلِ المقتدرِ، وإلَّا أئمت الأُمَّةُ كلُّها، فموتُ العلماءِ إيذانٌ بتفشيِ الجهلِ وترديِ الأُمَّةِ ، وهو نذيرٌ شوِّمٌ لا محالةً، فيتَّخذُ النَّاسُ رؤوسًا جهالًا يفتونهمُ بغيرِ علمٍ ، فتكونُ فيه ضلالُهمُ وعيُّهمُ وتيهُّمُهمُ .
" أكثرُ أهلِ الجنَّةِ البلهُ " ، هكذا قالوا !!! .

مجانينٌ غيرُ أنَّ سرَّ جُنُونهمُ على أعتابه يسجدُ العقلُ !!! .

جاءَ في 'النهاية' لابن الأثير {مُفسِّرًا البلهُ الذين هم أكثرُ أهلِ الجنَّةِ}: البلهُ هم الذين غلبت عليهم سلامةُ الصِّدْرِ وحسنُ الظنِّ بالنَّاسِ، لأنَّهم أغفلوا أمرَ دُنياهم ، فجهلوا جذقَ التَّصرُّفِ فيها ، و أقبلوا على آخرتهم فنتَّغلوها أنفسَهُمُ بها ،

18 _ الفصيمي عبد (الله) / هذه هي الأغلال / (ط) ، ص 265.

100 _ الفصيمي عبد (الله) / هذه هي الأغلال / (ط) ، ص 265.

20 _ الزكاة باب النَّهي عن مسألة: 2 / 718، والتِّرْمِذِي (379 هـ) أبو عيسى مُحَمَّد بن عيسى التِّرْمِذِي " أبواب العلم، باب إذا أراد (الله) به خيرًا يفقهه في الدِّينِ 5 (101)- رواه البخاري (356 هـ) كتاب العلم باب من يرد (الله) به خيرًا 11 / 150 / 151 _ 6 / 152 / ومسلم (361 هـ) كتاب 28.

102- ابن قدامة المقدسي أحمد بن مُحَمَّد بن عبد الرحمن / مختصرُ منهاجِ القاصِّدين / (ط) 8 / ص 10 .

103_ "مُحَمَّد بن يزيد القرويني / سنن بن ماجه / (ت 375 هـ) باب فضل العلماء و الحثِّ على طلب العلم، رقم 224.

فاستحقُّوا أن يكونوا أكثر أهل الجنَّة، وهكذا قال غيرُ ابنِ الأثير، وهم يقصدون أن المؤمنين حقًّا، الذين يحطون بدخول الجنَّة هم الذين يتصفون بالعبادة في الشؤون الدنيوية وبما يلزم لها؛ وقال أحدُهم في تفسير البُله: الأبله هو الأبله في دنياه، الفقيه في دينه، ومما ذهب مثلاً قوهم: [العجز عن الإدراك إدراك]، يعنون امتداح الجهل، وإن الجاهلين هم العلماء حقًّا، لأنهم عرفوا قدرهم وهو الجهل، فوقفوا عنده؛ إن هذا يُظهر أن الفسادَ الفكري كان عامًا عند هؤلاء، وهو فسادٌ أصيلٌ فهم؛ لم يكتفوا بمدح الفقرِ والمرضى والجوع، وكلِّ ألوانِ الشقاء، بل امتدحوا الجهلَ والغباءَ والجنونَ وضعفَ العقلِ والعجزَ عن التصرف في الحياة!!!، فهم لم يقفوا عند هجاء الثراء والصحة والعافية، بل ذهبوا بكلِّ ما أوثوا من بله يهجون العلمَ والمتعلمين، والعقلَ والعاقليين، قصدوا إلى كلِّ مقومات الإنسانية، وكلِّ عناصر الحضارة والمدنية، محاولين هدمها وتدميرها؛ لقد غزت هذه الثقافة التدميرية المسلمين على مدى ألف سنة أو يزيدون، [من القرن الرابع الهجري إلى يومنا هذا]، يتظنون إلى العلوم التي لا تتصل بالعبادة الحرفية الشخصية بعين الجفاء والاشمئزاز والبغضاء، وإلى من يحاولون هذه العلوم ودراستها أو ترجمتها نظرًا كلُّه ومقت وانها.

"لقد ظلت أوروبا تقاتل الجهل والظلامية قرونًا قتالًا عنيفًا، يُحرق العلماء ويُدفنون أحياءً ويُكَلِّبُ بهم، حتى ظفرت بمذه الطفرة العلمية المشهوددة؛ لقد كان المسلمون مخدوعين مغرورين مُتأثرين بسحر كلام أولئك الشيوخ المدمرين، الذين خلفوا وراءهم هذا العداء للعلوم، إنهم أفاكارٌ فاسدة انثرت من قياسٍ فاسدٍ، رأوا باستقراءهم الناقص أن الغباء والعجز والفقر العقلي قد يقارنه الصلاح والإنقطاع للعبادة، وأن الذكاء والعقل والنُبوغ والعبقرية قد يخامره التمرؤ والشروء والريب، فكانت النتيجة عندهم أن الأذكى والعقلاء والعلماء يضلُّون ويكفرون، وأن البله والأغبياء والجهلاء قومٌ يتصفون بالصلاح والطاعة والإستقامة وسلامة الطوية والاستسلام لله والقضاء والقدر، في كلِّ ما يطلُب منهم أو يُحكَم عليهم دون أن ينبض لهم عرق بالإباء والامتناع...، ثم هم لم يحتاجوا لكثيرٍ من التفكير ليميزوا أيَّ الفريقين أحقُّ أن يُتبع، ومن أيهم يجب أن يكون المسلم...!!!، والثانية: أن معظم أولئك أقاموا على عروش الرعامية والسيادة الألوهية، لأنهم يدركون بدهاء أن الأغبياء والجاهليين والبله هم الذين يسهل اقتيادهم، أما العلماء والعقلاء فيعسر عليهم استزلامهم، فملكوا على الناس من دون الله قلوبهم وجيوبهم، من هنا قيل: العلم حجاب، والجهالة أم الفضائل، اللهم ديناً كدين العجائز، والعجز عن الإدراك إدراك. إن من يعتقد أن العلم والعقل الممدوحين في الإسلام هما الخاصان بالأمور الدينية فقط فقد وهم، إن العلم ليس هو من أمر بالحروب ولا هو أوقدها ولا دعا إلى إلقاء الساحقات الماحقات على الأبرياء، ولكن الذي أمر بها وبتصنيعها، إنما هي الأحقاد والأطماع والمصالح...، إنما وظيفة العلم إنارة الطريق واستبانة الرشد؛ ومن قال إن علم الفيزياء النووية والهندسة الوراثية وهندسة المعلوماتية، يلام على مخلقاتها وحماقات مخترعها لزمه أن يلوم الذات الإلهية لإيجادها هذه الأشياء والعقل والذكاء الذي يستعمل الشر!!!"⁽¹⁰⁴⁾.

المطلب الثالث: التأثير التدميري للتعلم والجهل بالشريعة الإسلامية و أدواتها (فقه التوقع وفقه النوازل و سنن التدافع)، على مفهومي الإيجاء و التربية الإستقلالية.

إنَّ الجهلَ بالشريعة ومجالاتها تكمنُ في الجهل المطبق بأبواب الفقه وأصوله، و التفسير وشروحه، و الحديث ومعانيه روايةً و درايةً، وفقه النوازل والمصالح المرسله، وغيرها من أبواب أصول الفقه تتجاوز العقول المحدودة؛ إنَّه لم تُعدْ ثمة مختصات موثوقة أكاديمية راسخة لمدونات ومطولات الحواشي وحواشي الحواشي، التي أثرت التراث الإسلامي في شتى مجالات وفنون وفروع العلم الشرعي بمختلف نوازله وأحداثه المدهمة، هذا دفع بالأعرج ومن يُحسبون على العلم الشرعي ممَّا ذرَّ قرئه، إلى الإجتراء من ذلك بالوشل

فيأولونه على غير محمله، وهنا طائفة الطائعات وآفة الآفات، التي كانت ولا تزال سبباً في سفك دماء المسلمين أهلاً بفتاوى متهافتة ضيقة النظر في أحسن أحوالها، تصطدم بأبسط دليل شرعي لا بل تخالفه؛ إن النصوص الشرعية تحتاج لفهمها وإنزالها منازلها إلى إعمال نظر من لدن عقول راجحة شديدة الإتيان لكافة علوم الشريعة بكل تخصصاتها، وفوتوحات الفهم مع التحرير الدقيق ومعرفة مواطن الترجيح؛ إنك لما تستقري تاريخ عقول الاجتهاد وأدواته لدى الأئمة العظماء الراسخين في شتى فنون العلم والمعرفة خصوصاً الشرعية منها، ألفتها عقولاً جبارة ذات نظرٍ فسيحٍ في تحليلها وتعليلها، عقولٌ درست الشريعة من جذورها، وتعدت من أصولها، وسبرت فروغها، ولقحت بعضها بعضاً، فالشريعة مقاصد ومصالح متفاعلة مع كل زمان، والتدليل على ذلك يكون بقدر زناد الفكر، لتتبع الأدلة واستنباطها وصياغتها وإحلالها محلها وموضعها من غير تعسف أو خبط عشواء، وهذا يحتاج إلى زادٍ وفيرٍ وقدمٍ راسخٍ في العلم، حتى لا تزال، وتتجنب الخطأ والخطل، فيكون التتقيف والتوجيه سديداً.

إن الشريعة إنما شرعت أحكامها ومضامينها للدفع عن الناس غائلة الأوزار والآصار، فهي في جوهرها تحقيق للمصالح وفق المقاصد الشرعية، ودفع للمضار تبعاً لتطورات ومستجدات شؤون العباد في عاجل أمرهم وآجله إعمالاً (لفقه التوقع)؛ إن إتقان علم مقاصد الشريعة أمرٌ ضروري، بل أشد لفهم الواقع ومستجداته ومسارته، وهذا لا يتأتى بالأمان أو ببضاعة في العلم مزجاً، فلكل فن رجالته وأعلامه ومتخصصوه ومقاصده، خصوصاً [فقه التوازن] الذي باتت تتقاذفه أمواج الأثرة العاتية، وكُلُّه يشدُّها إلى القاع السحيق، فإلّا من الفقهاء اليوم والمتخصصين يُدركون بل يُلحون على ضرورة تحديد فهم مسائل الفقه بتخصصاته كلها في الدين والحياة، في السياسة والاجتماع والاقتصاد والعسكرة والفكر والثقافة بجميع روافدها، والوعي بالأصول والتراث للبناء على ما مضى من المؤسسات على تقوى من الله ورضوان، حتى لا تنقطع الروافد عن الأصول؛ إنه لم يلجأ أئمة كبار على رسوخٍ عظيم وفكرٍ ثاقبٍ أمثال (الإمام الشاطبي) صاحب 'الموافقات' وغيره كثير -رحمهم الله- لطرح مفهوم المقاصد الشرعية، إلا بعد أن عاينوا واستبصروا عجزَ فقه واجتهاد زمانهم عن معالجة الواقع ومواكبة أحداثه ونوازه. يقول (وائل الحلاق)⁽¹⁰⁵⁾: "تكمُنُ فِراذَةُ الشَّاطِبي -رحمه الله- كما قال بعضُ العلماءِ في أَنَّهُ عندَما لا حظَّ عَجَزَ الفِقه عن معالجة التَّغْيِيرِ الإِجتماعي و الإِقتصادِي في القرن الثَّامن /الرَّابع عشر/ في الأندلس، حاول في نظريته أن يستجيب للحاجات الخاصة بزمانه عبر إظهار كيف يمكن جعل الشريعة ملائمة للظروف الاجتماعية الجديدة و استجابة أصول الفقه للمجتمع.

إن الأسباب التي أدت إلى بروز نظريته لم تنجم أبداً عن رغبة في إنشاء آلية نظرية تقدم المرونة وإمكان التكيف مع الفقه العملي، بل تُشدُّ على أن نظرية الشاطبي لما فيها من ابتكارٍ وصياغةٍ جديدةٍ استهدفت إعادة ما يعده (الشاطبي) فقه الإسلام الحقيقي، الفقه الذي زيفته ممارسات متطرفتان في زمانه إلى يومنا هذا، **1** -مواقف المفتين السلطويين المتهاونة، **2** -المواقف الفقهية المفرطة، وثيار الصوفية المغالين، الذين لا يخلو وجود عدد كبير من العلماء والفقهاء في صفوفهم"⁽¹⁰⁶⁾؛ إن الأدوات التي نحتها والآفاق التي فتحها، من أجل منح الفقه روح فهم جديدة أغنى وأبعث على مواكبة العصر وما أصله من علاقة جدلية {بين الدين والإنسان}، جعل من البحث أكثر حيوية، تم استثمارها في بحوث المتخصصين في العلوم الإنسانية لاحقاً، وإنما اقتفى الشاطبي أثر علماء راسخين قبله، وإن كان ما جاء به مختلفاً من حيث الطرح والبناء وسعة النظر، إمامه في ذلك (القرايئي) -رحمهما الله- أحد أولئك الجهابذة الذين استنار الشاطبي بطروحاتهم، ولقح أفكاره بفكرهم في كتابه الشهير 'الفروق' الذي يقول فيه -رحمه الله-: "لا تجمد على المسطور في الكتب طول عُمرِكَ، بل إذا جاءك رجلٌ من غير أهل إقليمتك يستفتيك، لا تجره

105- الحلاق وائل / تاريخ النظريات الفقهية في الإسلام / (ط2) ، ص 130 .

106_ الحلاق وائل/ تاريخ النظريات الفقهية في الإسلام/ ترجمة وتحقيق أحمد موصلي/ فهد بن عبد الرحمن الحمودي(ط2) دار المدار الإسلامي 2010/1430م ص 214.

الدِّعَاءِ ، تعطيلُ العقلِ بثقافةِ الخمولِ " (108)؛ يقولُ وليام شكسبير : "حشدُ العقلاءِ أمرٌ معقّدٌ للغاية ، أمّا حشدُ القُطيعِ فلا يحتاجُ إلّا إلى راعٍ وكلبٍ" .

إنَّ إسنادَ ثقافةِ الخمولِ إلى مفهومِ القضاءِ و القدرِ جرمٌ عظيمٌ واستكاثرةٌ مميّنةٌ للظروفِ ، وانصياعٌ ذليلٌ للأوضاعِ ، وتعطيلٌ لكلِّ أشكالِ العقلِ المنتجِ و المبدعِ ، وما هو إلّا شتاعةٌ تُعلّقُ بها كلُّ الأخطاءِ و الهزائمِ ، وتُبرِّزُ بها كلُّ الانتكاساتِ و الارتكاساتِ ، العقلِ السَّقِيمُ المأزومُ الهزومُ ، الَّذِي لا يجرؤُ على مواجهةِ الصّعابِ و الانتصارِ عليها ، فيلوذُ بمسألةِ القضاءِ و القدرِ ليوارِي سِوَةَ عَجْزِهِ ؛ إنَّه العقلُ {التَّبريريُّ} الَّذِي يشكِّلُ أخطرَ بيعةٍ حاضنةٍ للتَّفاقِ بكلِّ أنواعِهِ ومُستنسخاتِهِ ، فرّقَ بينِ الأُمَّةِ الَّتِي تَعْنَى بِمَجْدِ أَجْدَادِهَا ، وَأُخْرَى مُنْشَغَلَةٌ بِصِنَاعَةِ المجدِ لِأَحْفَادِهَا ؛ إنَّ التَّفكيرَ ليسَ صفةً طَبِيعِيَّةً فِي الإنسانِ ، لَأَنَّهُ تَفكيرٌ مُضادٌ لِلطَّبِيعَةِ البشريَّةِ ، فَالناشِ مَيَّالونَ إلى الإحتِماءِ بِبعضِهِم بِبعضٍ ، مَيَّالونَ إلى الأحاديثِ الجماعِيَّةِ ، أمّا التَّفكيرُ فهوَ مَجهودٌ شَخْصِيٌّ يَتطلَّبُ إعمالَ العقلِ و التَّحرُّرَ من الإنْصهارِ الجماعيِ الأعمى و الغوغائيَّةِ الجمعيَّةِ ؛ إنَّ (عقيدةَ الجبر) تَكْرِسُ مَفهومِي التَّقليدِ الأعمى و الإنقيادِ الدَّلِيلِ ، النَّابعِ من تَكْرِيسِ مَفهومِ القُصورِ الدَّائِي و الجهلِ الكامنِ فِي العقلِ الَّذِي يَقولُ بِحُكْمِ الأُمواتِ لِلأحياءِ من عِلْمِ البَرزخِ .

إنَّ الأُمَّةَ نَعيشُ جَهلاً مَقْدَساً تَتَعَبَّدُهُ من دُونِ اللهِ من (40هـ) . إلى يومنا هذا ، الفِكرُ التَّاسُلُمِي أو الإِسْلامِي ، ابتداءً من حُرُوبِ الرِّدَّةِ ، الجهلُ المَقْدَسُ بسببِ الفِكرِ الشُّمُولِي و الحِكمِ الشُّمُولِي و المَلِكِ العَضُوضِ المَدْعُومِ {بِالجبرِيَّةِ و الإِرْجاءِ و الاعتزالِ و العصا الصُّهْيُونِيَّةِ} ، نَتاجُ تَكَلُّسِ العُقُولِ و الأرواحِ ، إنَّ المَجتمعاتِ المُسلمةَ ، اليَوْمَ و العقلِ المُسلمِ ، أسرى الفِكرِ المُتاسِلِمِ و الفِكرِ الإِسْلامِي معاً " (109) ؛ وَفِي انْحِرافِ العقلِ المُسلمِ يَقولُ د. عبد الحليم أبو شُقَّة : " إنَّ انْحِرافَ العقلِ يَعني أَنَّ هُنَاكَ داءٌ قَدْ أَصابَ الكينونةَ البشريَّةَ ، وَلِتِلْكَ الحِالِ أَعراضُها الَّتِي تَكشِفُ عنها وَهي : 1 - الغفلةُ عن القواعدِ الأُصولِيَّةِ و القواعدِ الفِقهِيَّةِ ، وَعَدَمُ مِراعَةِ الأُولُويَّاتِ ، 2 - الغفلةُ عن مِراعَةِ درجاتِ المِصلِحَةِ و المُفسِدةِ ، 3 - الغفلةُ عن دراسةِ الواقعِ و مِلاحِظَةِ ظواهرِهِ عندَ تَقْريِرِ الأحكامِ ، وَكذا الغفلةُ عن التَّأمُلِ الفِكرِي ، 4 - الوقوفُ عندِ المُشْتَهياتِ و تَحْريمِها دونَ الرِّجوعِ إلى أَهلِ الفِكرِ و الفِقهِ الحَقِيقِي ، وَبِهذا يَقَعُ الغلُوُّ فِي الإِحْتِياطِ ، 5 - الغفلةُ عن مِراعَةِ شروطِ سِدِّ الدَّرَائِعِ ، يَتَّبِعُها غلُوٌّ فِي الإِحْتِياطِ ، 6 - الغفلةُ عن ضُرورةِ التَّعَدُّدِ و التَّنوُّعِ ، الَّذِي يَسْري نَتِيجَةً اِختِلافِ العُقُولِ وَحَقِّ الاجْتِهادِ لِلْمُؤَهَّلِ لَهُ ، 7 - التَّفَوُّرُ من الحِوارِ معِ المُخالِفِ بِدَلالَةٍ من الحِرصِ على الحِوارِ البَنائِ ، 8 - الغفلةُ عن المِنهجِ الشَّرْعِي ، مِثْلُ إِجْراءِ الأحكامِ على الظَّاهِرِ ، يَتَّبِعُها الاِتهامُ معِ التَّعَرُّضِ لِلنَّوايا وَتَبادُلِ التُّهْمِ و التَّراشِقِ بِجِرابِ الباطلِ " (110) . وَ منِ الأسبابِ المُوجِبَةِ لِلانْحِرافِ العقلِ المُسلمِ و حُطُورَتِهِ على بِناءِ الفِردِ و المَجتمَعِ و الحِضارةِ الإِنسانِيَّةِ و الكينونةِ البشريَّةِ .

1 _ المِزالِقُ الفِكرِيَّةُ الخَطِيرةُ : " 1 - التَّفْسِيرُ بِالرَّأيِ دونَ عِلْمٍ و لا كِتابٍ مُبِينٍ ، يُمَثِّلُ مِزالِقاً فِكرِيّاً خَطِيراً ، فهوَ تَحْرِيفٌ مُباشِرٌ لِلشَّرْعِ ، 2 - الرِّعْمُ بِأَنَّ الدِّينَ حَلٌّ سَحْريٌّ لِكُلِّ مَازِقٍ و أزماتِ الحِياةِ ، مِمَّا قَدْ يُفْهَمُ خَطأً ، فَيَظُنُّ النَّاسُ أَنَّ الحِياةَ تَسْتغْنِي عن التَّفْكيرِ و إعمالِ العقلِ ، وَهو مِزلقٌ فِكرِيٌّ خَطِيرٌ ، لَأَنَّ العَقْلَ هوَ أداةُ اسْتِنباطِ الأحكامِ و التَّشْرِيعاتِ ، 3 - القَوْلُ بِأَنَّ السَّيرَةَ النَّبَوِيَّةَ مُصدرٌ تَشْرِيعِيٌّ دونَ التَّنْظُرِ إلى أَحكامِ الفِقهِ ، وَهي الَّتِي حوتِ جَمِيعَ النُّصوصِ الَّتِي تحوي على جَمِيعِ الأحكامِ ، وَجمعتِ إليها اجْتِهاداتِ عِلْماءِ كَثِيرين سِيكوُنُ اجْتِهادَهُم توطئةً لِاجْتِهاداتِ أُخْرَى ، 4 - الفِصامُ بَيْنَ النَّظَرِ فِي النُّصوصِ الشَّرْعِيَّةِ ، أو اعتبارِ حَدِيثٍ واحِدٍ مُصدرًا ، بِوجودِ أَحاديثِ أُخْرَى ناسِخةٌ أو مُخصَّصةٌ ، 5 - مِعرفةُ الحَقِّ بِالرِّجالِ ، وَقد يُوْدي الفِهْمُ المُتَنَكِّسُ هذا إلى مِزالِقٍ أخطرَ مِنْها : 1 - الخِلاطُ بَيْنَ ما هو سَمائِيٌّ و ما هو وَضْعِيٌّ ، 2 - الإِعْتِماءُ على السَّماعِ دونَ الكِتابِ الَّذِي يُعْطِي

27- د.باسل علي الخطيب / تغريبُ العقلِ عَقْلِيَّةِ البَارامِسيومِ / (ط1) ص 23.

28- باسل الخطيب / تغريبُ العقلِ عَقْلِيَّةِ البَارامِسيومِ / (ط1) ص 23.

110 _ المصدر نفسه / (ط1) ص 23.

فرصة التأمل، ③ - الجمود على رافدٍ علميٍّ معيَّنٍ بكلِّ سلبياته ، ④ - التفور من التقدير والفكر المعارض بوصفه الضرار، ⑤ -
الرّهادة في الفكر الحديث و الإعراض عنه بمبرراتٍ ساقطةٍ" (111).

2 _ سيطرة ثقافة السلب: ① - سيطرة الروح الإخزامية في مواجهة الفكر الضرار، وترسيخ روح الموروث، ② - طغيان
الظاهر على جواهر الأمور وضبط المعاني، ③ - الانشغال بالجزئيات عن الكليات وفهمها منفصلةً عنه، ④ - العزوف عن
الإبداع و الأصالة ، و الركون إلى التقليد و التبعية عن عجزٍ ومنطقٍ فاسدٍ، ⑤ - تقديم التوافل على الفرائض لميل الهوى، ⑥ -
الإتكالية و الحيدة عن الأخذ بالأسباب ، ⑦ - الصنمية و شخصنة المبادئ والأفكار، ⑧ - الخلط بين الثوابت والمتغيرات ،
وتقديم ما ليس بمقدسٍ، ⑨ - السطحية والعجز عن التأصيل والتعميق، ⑩ - الميل إلى الإرتجال والتزوغ إلى أجم الآخر، ⑪ -
الانشغال بالشعارات دون وعي مفاهيمها، ⑫ - الفصام بين الفكر و العلم و الكسل العقلي، ⑬ - توهم التعارض بين الدين
و العقل و العلم ، وحصص العلم في الوحي المنزل، ⑭ - الفصام والتناقض في الشخصية ، ⑮ - عدم وعي العقل بمحدود المتناقضات
، ⑯ - الإبحار في عالم الخيال هروباً من الواقع، ⑰ - المجازفة بالتعميم في الأحكام ، وعدم تحديد المفاهيم ، وغياب الموازين،
⑱ - التفكير الأحادي ، وغياب المعايير الصحيحة التي تُعرف بها أقدار الأشياء وقيمتها، ⑲ - التحيز إلى الذات بلا تعقلٍ، و
المبالغة في إبراز المزاي ، وغيوب المخالفين، ⑳ - عدم استشعار الواقع كما هو عليه ، والتبصر بعد النظر، و اليأس من استصعاب
الحل، 21_ عدم تحرير المصطلحات والمفاهيم وتحديدتها، مما يؤدي للغموض أو التثؤش أو الانحراف" (112).

3 _ شيوع مخدرات العقول : ① - "حشو الذهن بفظ المتون والشروح واستيعاب الهوامش، ② - استلاب حربة الآخرين
سياسيةً، اجتماعيةً، اقتصاديةً ، و الإرهاب الفكري من المؤسسات الدينية الكهنوتية و الأنظمة الشمولية الإستبدادية، ③ -
الحرمان من المواد اللازمة لنمو العقل، ④ - حفظ العلم لامتحان ، بدلاً من فهم العلم للحياة، ⑤ - التلقين بدلاً من الفهم و
الإستيعاب، والإكتفاء بالكتاب المدرسي المتهاون ذي السطحية و الضحالة العلمية" (113).

4 _ الآثار الناجمة عن تعطيل العقل: ① - "بتعطيل العقل انخرت بنا الأهواء بعيداً عن عقيدة السلف فنشأت مدارس
الكلام، ② - بانحراف الأهواء عن العبادة الصحيحة نشأت مدارس التصوف البدعي، ③ - بانحراف الأهواء عن الأخلاق
الصحيحة الفاضلة رسخت التقاليد وممارسات منحرفة، ورائها فقه قاصر جامد مختل، وتصوف منحرف، ④ - بانحراف الأهواء
عن الفقه الصحيح حدث الجمود و الانحراف الفقهي ؛ نتج عن ذلك كله الانحراف عن المنهج الإلهي، والافتراء على التشريع بالتغيير
والتبديل، إنَّ العلة تتمثل في الإستبداد و اعتقال العقل المسلم وتحميده واسترخاصه والحط من شأنه، واعتقاله على ثلاثة محاور :
(التعليم و الدين و السلطنة) (114).

إنَّ العقل المسلم يفتقد القدرة على الرؤية البانورامية الشاملة ، ويركز على جزئيات المشاهد، دون احتواء ورد الظواهر إلى أسبابها ،
فهو لا يرى الحلول الوسطية ، إنَّ عقلنا لا يتسع للآخرين، ولا يقبل الاختلاف والخلاف ، وإنما يصادف ما سواه إما يذمّه أو إقصائه
، وأما الانتقاد فهو مساس بالذات ، عقل متشبع بالجهل و الأمية و العصبية القبلية و الطائفية المسيخة ؛ ويستمر لظى الخلافات
المذهبية مشتعلًا بوقود الحقد و الجهل للانتماء ، مُصْرَبين على المضى إلى نهاية المسار ، "حوصر العقل المسلم بالتصوف وعصا
السُلطان ، و اعتبار ذلك تسليمًا بالقضاء و القدر، وأجم العقل بالغباء و حماقة و الجهل و الكفر، إنَّ العقل المسلم قد طاله
البطش و الاستهباب ، وتم ترويضه بعصا الإستبداد وتعطيله بخرافات وشطحات وجدنة الطرق الصوفية التي ولدت البهائية

30_ أبو شقة / نقد العقل المسلم ، الأزمة ... و المخرج / (ط1) ص 16_17-18.

31_ المصدر نفسه / (ط1) ص 16_17-18.

113 _ أبو شقة / نقد العقل المسلم ، الأزمة ... و المخرج / (ط1) ص 72

114_ المصدر نفسه / (ط1) ص 72 .

تَسعى الفلسفات الحديثة لخلق أهدافٍ بعد أن تحطّم العقل بالعجز عن الإجابة عن أسئلة الوجود الكبرى، كي لا يُصبح الإنسان بقرّة أو زعيماً على أبقارٍ، تكون مهمته قيادتها إلى المرعى الخصب، ولكن بتحطيم العقل ستفشل، وتكون المأساة بسقوط الحضارة حقيقة لا يمكن تجنبها، المأساة التي صنعتها الفلسفة الحديثة، إذ جعلت من الحضارة طعاماً وجسناً؛ لقد غاب الهدف، ولم يعد للحيوانات المعاصرة غير هذه الكومة التي تبحث فيها عن معنى لوجودها، ما من مجتمع قبل مجتمعا عرف مثل هذا التمزق؟!؛ "إن مرض النفس الإنسانية المعاصرة هو هذا الكذب المتأصل في الكيان الخلفي والاجتماعي، هذا المرض الذي يثير مشاعر الخوف والبغضاء، بل ومشاعر الضياع تجاه الثقافة العلمية الحديثة، أين يجد المريض الدواء إذا كانت الأمراض النفسية قد أصبت كل البشر، فتلاميذ [فرويد] إما مُنتحرون أو مكتئبين، وتنتشر طريقة الانتحار (السييزيفية) للتخلص من [الأنسا] التي تلوثت بنفايات الحضارة المعاصرة؛ إنها نار الكبرياء التي تمنع الجاهل من الخضوع لمن هو أعلم منه، وتمنع النفس من الخضوع للعقل، وتمنع العقل من الخضوع للروح، مشكلة الأبواب المغلقة التي لا تُفتح إلا للمتواضعين، فعلى النفس أن تخضع للعقل وتعلم منه، وعلى العقل أن يخضع للروح ويصغي إليها" (119)، و إنما ينساق العقل إلى الاستسلام أمام تحدي النفس وإغراءاتها كلما تضاعفت معرفته، ولهذا لا تصمد العقول غير المحصنة بالمعرفة العالية أمام الإغراءات الدنيوية، فكان لا بُد لكل شريعة من تحصين العقل بالمعرفة، لتدريبه على مواجهة النفس وصد شراستها ومكرها لخرق قوانين العقل وتحطيمها، فبدأت كل شريعة بـ [أقرأ] لتعرف وتعبر جسر النفس إلى نور العقل" (120).

إن العقلانية من شروطها سيادة العقل على النفس وليس العكس، فإذا غاب العقل واستبد الهوى ودخل الإنسان في زمرة الحيوان بأفعاله، فإذا جعل مستوى التنظيم الاجتماعي مقياساً للرقى العقلي دون معرفة أهداف التنظيم وغاياته، قد ضلنا إذاً عن الاتجاه الصحيح بحفنة من التظم والقوانين؛ "إن الحضارة تفوق القيم الإنسانية والأخلاق، وهو السمو الذي كان محور كل الرسائل السماوية والحضارات العظيمة، وهدفها الدائم الإنسان الفاضل في مواجهة الإنسان الحيوان، العقل في مقابل العريزة، و السمو المعرفي في مقابل الانحطاط والهبوط، هو نظام دولة النفس مقابل دولة الوحي" (121).

إن تحويل منظومة الاستبصار وإدارتها إلى خلاف فطرتها والمقصد والغاية والمثنة والمصلحة والحكمة والشريعة التكميلية، ذلك هو العمى والضلال المبين باستبطان آلهة الهوى، وهو لازم معنى أن الحواس الإنسانية تصبح معطلة، وغير قادرة على أداء وظيفتها الإنسانية الاستخلافية في فهم الحياة بآثارها وتوائجها، عندها يفقد الإنسان خصوصية العقل فيصاب بالعمى الحقيقي؛ إنه إذا اختلفت الإرادة السلوكية للإنسان مع إرادة الله التشريعية، يسقط الإنسان لا محالة في مهاوي الضلال والفساد وسفك الدماء، لوقوعها تحت تأثير القوى الغضبية والشهوية، يقول الطَّبَّاطي: "إن الوجود على الأرض مادي مركب من القوة الغضبية والشهوية، والدائر دائر تزاخم محدودة الجهات وافرة المزاومات، مُركباً في معرض الانحلال، وانتظاماً وإصلاحاً مظن الفساد ومصبب البطلان، ولا تتم الحياة فيها إلا بالحياة النوعية، ولا يكمل البقاء فيها إلا بالاجتماع والتعاون؛ إن الإرادة الإنسانية بما أعطيت من اختيار تتحكّم في توجيه العقل بمعلوماته الناقصة، هي التي تؤدي بالإنسان إلى أن يفسد في الأرض و يفسك الدماء." (122).

يؤكد محمد باقر الحكيم أن الإنسان في حركته لإشباع الغرائز ينجح بصورة عامّة إلى تجاوز الحدود المعقولة في الإشباع، ينساق مع الهوى فيتحوّل إلى سلوكٍ فيه..، فينسلخ من آيات الله، ومن إرادة الله التشريعية إلى إرادته هو، وبذلك تنتكس علاقته

119- محمد عرب / شرائع النفس والعقل والروح / (ط1) ص 244 بتصرف.

120- المصدر نفسه / (ط1) ص 247، بتصرف.

121- محمد عرب / شرائع النفس والعقل والروح / ص 15 _ 371، بتصرف.

122_ محمد حسين الطبطبائي/الميزان في تفسير القرآن/ نص (ط1) (ج1) ص115.

بما حوله من العوالم الكونية ، فتصبح القوة والقدرة مثلاً يُحتذى في الخضوع والتسليم له ، فيتجاوز الحدود الفطرية التي أوجبتها الهداية الإلهية وحدتها إرادته ، فتبرز بذلك الطاعة المزاحمة للتوحيد الحق⁽¹²³⁾ ؛ إنَّ اختلالَ عامل السلوك والإرادة الإنسانية يؤدي إلى أن تصبح علاقته بالكون وحركته ومكوناته علاقة عذاب واضطراب وفساد، وهو في هذا التمرّد يستهدف وجوده مباشرة و المركب الذي يديره⁽¹²⁴⁾ .

المطلب السادس : الوثنية والشرك والاستبداد والملأ المترفون والعرافة الغيبية وأثرها في الفوضى الفكرية والدينية والعقدية ، والمهدية وعقيدة حتم النبوة ، وأبعاد ذلك على الإجماع والتربية الاستقلالية وبناء الفرد والمجتمع والحضارة الإنسانية .

إنَّ الإسلام الكونيَّ يجارب كلَّ الحركات الداعية إلى عبادة الطواغيت ، ويقف في مواجهتها على اختلاف أصنافها وأيديولوجياتها ونجليها ، إنَّه يدعو إلى الثورة ضدَّ كلِّ طغيان، وكلِّ خطابٍ وأيديولوجيا تمجّد الطاغوت أو تدعو إليه ؛ إنَّ الطغيان هو مرأة [ما تُنحتون]، إنَّها شاملة لكلِّ ما من شأنه أن يكون صنماً يُعبَد ، أو رأسمالٍ أو دمٍ أو عرقٍ أو قوميةٍ أو شعوبيةٍ أو عشائريةٍ أو علمانيةٍ أو شيوعيةٍ (الأيديولوجيات كلها)، بأشخاصها وأفكارها وقيمها ومبادئها ، إنَّها نماذج تطبيقية لمفهوم الطاغوت الذي يقف في مواجهة الله والدين الخالص ؛ يسعى (دين الشرك) الأيدولوجية والمعتقد الضرار، إلى تبرير الوضع القائم عبر الترويج للمعتقدات ذات الصلة بما وراء الطبيعية ، وإلى تحريف الاعتقاد بالمعاد والمقدِّسات والقوى الغيبية ، وتشويه العقيدة الأصيلة ، ليخدع النَّاسَ بأنَّه الوضع الأمثل الذي يُرتضى لهم ، لأنَّه مظهرٌ لإرادة الله ، وهو المصير المحتوم الذي كُتب عليهم ؛ إنَّ القضاء والقدرة بمفهومه المغلوط هو من مخلِّفات سياسة الملك العضوض، فالتاريخ يشهد أنَّ الاعتقاد بالقدرة والقول بالجبر أمورٌ من ابتداع السياسة ، تلت سقوط الخلافة، ليلبسوا على النَّاسِ دينهم ، دفعاً لكافة أنواع التقد ، لقتل رُوح المبادرة والثورة ضدَّ الطغيان ، لأنَّ الجبر يعني الانصياع لكلِّ ما هو قائمٌ ، والخضوع لواقعة الحال .

لقد صنّف النَّاسُ في التاريخ إلى شريفٍ ووضيعٍ وسادةٍ وعبيدٍ، الحياة الإنسانية هي الأخرى انقسمت إلى فئاتٍ وشعوبٍ وقبائلٍ ومزايا وطبقاتٍ ، وبتعددها تتعدّد الآلهة ، وسبيلُ الكلِّ الحفاظ على امتيازاته وحقوقه بدين الشرك ، الوسيلة المثلى لإخضاع النَّاسِ وإقناعهم بأنَّ الوضع القائم مجسّدٌ لمشية الله وإرادته ؛ إنَّ دين الشرك هو المكرس للوثنية ، إنَّ الوثنية تحرِّك النَّاسَ مع الهيمنة الحاكمة حيثما تحركت، وقد تُهيم عليها ك[الروحانية الحديثة] التي ترعاها الإنجيلية الصهيونية ، التي تقود العالم بجميع مؤسساته⁽¹²⁵⁾ . إنَّ المحفّرات الأساسية للدين الأفيوني (الشرك) هي الجهل والخوف والتَّمييز الطبقي والقهر والاستلاب والإغتراب ، إنَّه ذلٌّ ومهانةٌ وجهلٌ واستحمازٌ ، والأخطر منه هو الشرك الذي يخفي وراء نقاب التوحيد .

إنَّ دين الشرك أفيون الشعوب، واستحمازٌ وترويضٌ للنَّاسِ على الحرمان والشقاء باسم الاعتقاد بما بعد الموت ، وأنَّ كلِّما حدث أو يحدث هو من عند الله و بمشيئته ، وكلِّ محاولةٍ للتَّغيير إلى الأصلح هي مخالفةٌ لإرادة الله ومشيئته ، وعصيانٌ لأوامره (حقٌّ أريد به باطل) . إنَّ دين الشرك هو الذي حكم المجتمعات البشرية عبر التاريخ ويحكمها اليوم ، إنَّه وليد الإقطاع والطواغيت والخوف والرجعية والتعصب ، إنَّ ذلك كله مُتجسّدٌ فيمن حكم باسم التوحيد (ظاهراً)، أو حكم باسم دين الشرك (صراحةً) ؛ إنَّ الذين يُروجون لدين الشرك وبضاعته، هم أشدُّ خشيةً ورُعباً لوعي النَّاسِ ويَقْظَنهم ، إنَّه عدوُّ العلم والمعرفة ، فإذا حلَّت في النَّاسِ رُوح العلم والفهم والانتقاد ، تزلزلت أركان دين الشرك . "إنَّ الفكر الحرَّ

123- محمّد باقر الحكيم /المجتمع الإنساني في القرآن الكريم / (ط2) ص 244 بتصرف.

¹²⁴ _المصدر نفسه/ (ط2) ص 244 ، بتصرف .

125- د.علي شريعتي / دين ضدَّ الدين / (ط1) ص45_46 بتصرف.

ينبغي له أن يُقبل على إنقاذ الدين الحقّ ، ولئن لم يفعل فسيكون شريكاً لأعداء البشرية من الجلاّدين و السّحر و الكهنة و الفراعنة ، الذين اغتالوا الدين وأردوه خدمة لمصالحهم⁽¹²⁶⁾ ؛ لا شك أنّ الفضل في اتصال تاريخ الجهاد و التجديد و الأخذ على أيدي الظلمة و الانتصار للمظلومين في تاريخ الإسلام ، يرجع إلى اعتبار الأمّة نفسها مسؤولة عن إقامة الحقّ و العدل، و الأمر بالمعروف و النّهي عن المنكر، و الدّعوة إلى الدين الخالص، لا تنتظر لذلك مخلصاً يُبعث من محبّي ، أو قوّة غيبية تتصلّ بالسماء اتصالاً مباشراً ، أو تعتمد على شيء غامض عن العقول و الظواهر و يدقّ فهمه ، يقوم على مجرّد التقليد و التّقليد.

"إنّ الاعتماد على شخصيّة غامضة في التّاريخ (مقدّسة)، تحمل علوم الأوّلين و الآخرين وأسرار الأمانة الباطنة ، و الصلّة السريّة بينها وبين علامّ الغيوب ورسوله الكريم ، ممّا يستحيل على غيرها حملها، وسيئاً يجيء إلى العالم ليظهره و يقبل الأوضاع رأساً على عقب، هو ضرب من الاستخفاف"⁽¹²⁷⁾؛ إنّ قضيّة نبيّ جديد و عقيدة استمرار النّبوة ، و نزول الوحي ، و الكمالات و المخاطبات الإلهية ، أخطر و أعمق تأثيراً في العقول و النفوس، إنّها تجعل الأمّة فريسة الأعداء و الدّجاج الين و المنحرفين و المشعوذين و لعبة للظّالمين، هذا ما تمارسه بعض الأمم اليوم إغراقاً للمسلمين في الفوضى الدّينية و العقديّة و الاقتتال الطّائفي الدّخلي ، لإضعاف شوكتهم و فصلهم عن محيطهم العقدي، و واقعهم الاغترابي ، لغاية في أنفس القوم كشفت عن سواءهما الأحداث القريبة و البعيدة!!؛ "إنّه من فضل الله و رحمته بعباده المسلمين أنّ أكمل لهم دينهم قبل أن يغادر النّبيّ ﷺ ملتحقاً بالرّفيق الأعلى، و حتم نعمته على هذه الأمّة بنبيّها محمد ﷺ ، فلا نبيّ بعده ﷺ ولا فخر"⁽¹²⁸⁾؛ إنّ عقيدة (ختم النّبوة) هي حارس للدين و رصده من غوائل المتبدعين و فتنة المتنبئين و المترجمين، إنّها الحارس من الفوضى الفكرية و الدّينية و العقديّة التي عصفت بالأحقاب البائدة و شرائعها، إنّها قاومت المؤامرات كلّها و الصّدّامات كافّة.

يقول الفيلسوف الكبير محمد إقبال -رحمه الله: "إنّ النّبوة في الإسلام لتبلغ كما لها الأخير في إدراك الحاجة إلى إنهاء النّبوة نفسها ، وهو أمر يتطوّر على إدراكها بعمق لاستحالة بقاء الوجود معتمداً إلى الأبد على مقوّد يقاود منه ، وإنّ الإنسان لكي يحصل كمال المعرفة لنفسه ينبغي أن يترك ليعتمد في التّهيأة على وسائله هو"⁽¹²⁹⁾، و يقول -رحمه الله- أيضاً: "إنّ الأمّة لا تحكّمها أرواح البرزخ التي أفضت إلى ما عملت ، سواء من أهل آل البيت الأطهار -عليهم السّلام- أو كانوا من خيرة علماء الأمّة عبر أطوارها التّاريخية -رحمهم الله ورضي عنهم أجمعين- فلا الرّجعة ولا الاستمرار في النّبوة يقول به أحد من عقلاء الأمّة ، فضلاً عن علمائها و مجدديها، فلا يحكّمها إلاّ "كتاب الله و سنّ نبيّه ﷺ" ، قطعاً لدابر الفوضى العقديّة و الفكرية في أمّة الإسلام "وكفى بها نعمة" ، نبداً لجميع الأيديولوجيات بجميع أفكارها و مشاريعها . إنّ إبطال الإسلام للرّهبنة و وراثته الملك ، و إلزام القرآن العقل بالتّفكير، و إرشاده إلى أعمال النّظر الفسيح عند مضايق الأنظار، و التّجربة على الدّوام ، وإصراره على النّظر في الآفاق و الأنفس، و الوقوف على أخبار الأوّلين من مصادر المعرفة الإنسانيّة ، كلّ ذلك صوراً مختلفة لفكرة إنهاء النّبوة"⁽¹³⁰⁾، و محاربة للتّورة المضادّة (دين الشّرك).

126- د.علي شريعتي / دين ضدّ الدين / (ط1) / ص 51 ، بتصريف.

127- محمد الحسين آل كاشف الغطاء / أصل الشّيعة وأصولها /تح (ط1) ص 109.

128- أبو الحسن علي الندوي / اتّصال التّاريخ الإسلامي و التّجديد في الإسلام و سرّه / (د.ن)(د.ت)(ط1) ص 149.

48- محمد إقبال / تجديد الفكر الدّيني في الإسلام / (ط2) ، ص 152.

130- المصدر نفسه / (ط2) ص 154.

المصادر والمراجع :

- ابن جماعة بدر الدين محمد/ تذكرة السامع والمنتكلم في أدب العالم والمنتكلم/ بيت الأفكار الدولية /تحقيق حسان عبد المنان(ط1)
1424هـ 2004م .
- ابن قدامة المقدسي أحمد بن محمد بن عبد الرحمن/ مختصر منهاج القاصدين /المكتب الإسلامي / تحقيق زهير الشاويش (ط8)
1409هـ 1989م .
- أبو شقة/ نقد العقل المسلم الأزمه.. والمخرج/ (ط1) / 2003 م 1423 هـ .
- أحمد توفيق ، الإيجاء العقلي ، دار الأسرة للنشر والتوزيع، دار عالم الثقافة عمان الأردن، ط1 2006 / 1427 .
- ألفونس إسكروس ، التربية الاستقلالية ، ترجمة عبد العزيز محمد بك، ط4 دار الكتب المصرية القاهرة 1931 _ 1349م .
- باسل الخطيب/تغريب العقل، عقلية البارامسيوم / (ط1) دار النهضة والآداب 2018 م 1438هـ .
- الحلاق وائل /تاريخ النظريات الفقهية في الإسلام / ترجمة وتحقيق أحمد موصللي / فهد بن عبد الرحمن الحمودي(ط2) دار المدار الإسلامي " 1430 هـ 2010 م .
- رمزي مفتاح ، أسرار الإيجاء الذاتي، تدريبات عملية وعلمية في النفس والرؤحانية، ط1 1945 مكتبة الانجلو المصرية.
- الغزالي أبو حامد/ الإعتقاد/ دار أفنان "دمشق سورية" تحقيق علاء الدين الحموي" (ط1) 1419هـ 1999م .
- القصيمي عبد الله / هذه هي الأغلال ، منشورات الجمل ، (ط2) 1426هـ 2006م .
- أبو شقة/ نقد العقل المسلم الأزمه.. والمخرج/ (ط1) / 2003 م 1423 هـ .
- نبيل هلال هلال / اعتقال العقل المسلم ودوره في الخطا المسلمين تأملات في الحضارة والتقدم/ (ط3) / 1425 هـ 2005م .
- محمد عمارة وفؤاد زكريا / أزمة العقل العربي / (ط1) نخضة مصر القاهرة، 2003 م 1423 هـ .
- ستيوارت مل / الحرية/ ترجمة طه السباعي مطبعة الشعب (ط1) 1922م 1340هـ .
- محمد عرب /شرائع النفس والعقل والروح /إتحاد الكتاب العرب (ط1) 1425هـ 2005م .
- محمد حسين الطبطبائي/ الميزان في تفسير القرآن/ تصحيح الأعلمي حسين/ مؤسسة الأعلمي المطبوعات(ط1) 1403هـ 1983م (ج1).
- محمد باقر الحكيم /المجتمع الإنساني في القرآن الكريم/ مؤسسة تراث الشهيد الحكيم (ط2) منقحة 1427هـ 2006م .
- سيد القمني/ انتكاسة المسلمين إلى الوثنية، التشخيص قبل الإصلاح/ مؤسسة الانتشار العربي(ط1) 1430هـ 2010م .
- د.علي شريعتي / دين ضد الدين / الدار العالمية (ط1) 1404هـ 1984م .
- أبو الحسن علي الحسيني الندوي/ ماذا خسّر العالم بالخطا المسلمين/ دار السلام للطباعة و النشر(ط11) 1398هـ 1978م .
- محمد الحسين آل كاشف الغطاء/ أصل الشيعة وأصولها /تحقيق علاء آل جعفر(قم) إيران مؤسسة الإمام الصادق (ط1) 1414هـ 1994م .
- الندوي أبو الحسن /اتصال التاريخ الإسلامي والتجديد في الإسلام وسره/ (د.ن) (د.ت) (ط1).
- الماوردي أبو الحسن علي بن محمد بن حبيب/ أدب الدين والدنيا /دار الصحابة للتراث طنطا مصر تعليق أبو حذيفة إبراهيم بن محمد(ط1) 1410هـ 1990م .
- Ibn Jamā‘at Badr al-Dīn Muḥammad / tdhkrtu alssām‘i wālmtkllim fī adbi al‘ālim wālm‘llim / Bayt al-afkār alddawlyh / taḥqīq Ḥassān ‘Abd al-Mannān (T1) 1424h 2004m.

- Ibn Qudāmah al-Maqdisī Aḥmad ibn Muḥammad ibn ‘Abd al-Raḥmān / mkhtṣru mnḥājī alqāṣdy / al-Maktab al-Islāmī / taḥqīq Zuhayr al-Shāwīsh (ṭ8) 1409h 1989m.
- Abū Shuqqah / nqdu al‘qli almuslim al‘azmtu. wālmkhraj / (Ṭ1) / 2003 M 1423 H.
- Aḥmad Tawfīq, al‘yḥā‘u al-‘aqlī, dāru al-usrah lil-Nashr wālttawzy‘, Dār ‘Ālam alththaqāfti ‘Ammān al-Urdun, Ṭ1 2006/1427.
- Alfūns iskbrws, alttarbytu alāistqlāalyah, tarjamat ‘Abd al-‘Azīz Muḥammad Bik, ṭ4 Dār al-Kutub al-Miṣrīyah al-Qāhirah 1931 _ 1349m. 7.
- Bāsil al-Khaṭīb / tghrybu al‘qli, ‘qlyyatu albārāmsyūm / (Ṭ1) Dār al-Nahḍah wa-al-Ādāb 2018 m1438h.
- al-Ḥallāq Wā‘il / tārykhu alnnaḥryāti alfqhyti fī al’slām / tarjamat wa-taḥqīq Aḥmad Mawsilīlī / Fahd ibn ‘Abd al-Raḥmān al-Ḥammūdī (ṭ2) Dār al-Madār al-Islāmī "1430 h2010 M.
- Ramzī Miftāḥ, asrāru al‘yḥā‘i aldhdhāty, tdrybātun ‘mlytun w‘lmytun fī alnnafsyiti wālrūḥānyti, Ṭ1 1945 Maktabat al-Anjlū al-Miṣrīyah.
- al-Ghazālī abwḥāmd / alāiqṭṣādu fī alāi‘tqādi / Dār Afnān "Dimashq Sūrīyah" taḥqīq ‘lā‘alddīn al-Ḥamawī "(Ṭ1) 1419h1999m.
- al-Quṣaymī ‘Abd Allāh / hdhīh hya al’ghlāalu, Manshūrāt al-Jamal, (ṭ2) 1426h2006 M.
- Abū Shuqqah / nqdu al‘qli almuslim al‘azmtu .. wālmkhraj / (Ṭ1) / 2003 M 1423 H.
- Nabīl Hilāl Hilāl / a‘tqālu al‘qli almuslim wdawruh fī anḥṭāti almuslmyn t‘mmulāunt fī alḥḍārti wālttaqddum / (ṭ3) / 1425 h2005 M.
- Muḥammad ‘Imārah wa-Fu‘ād Zakarīyā / azmtu al‘qli al‘arby / (Ṭ1) Nahḍat Miṣr al-Qāhirah, 2003 m1423 H.
- Stuart Mill / alḥurrīh / . tarjamat Ṭāhā al-Sibā‘ī Maṭba‘at al-Sha‘b (Ṭ1) 1922m1340h.
- Mḥmd‘rb / sharā‘u alnnafsi wāl‘qli wālrūḥ / Ittiḥād al-Kitāb al-‘Arab (Ṭ1) 1425h2005 M.
- Muḥammad Ḥusayn al-Ṭabaṭabā‘ī / almīzānu fī tfsyri alqr‘āni / taṣḥīḥ al-A‘lamī Ḥusayn / Mu‘assasat al-A‘lamī al-Maṭbū‘āt (Ṭ1) 1403h 1983m (j1).
- Muḥammad Bāqir al-Ḥakīm / almujtam‘u al’nsānyyū fī alqr‘āni alkrymi / Mu‘assasat Turāth al-Shahīd al-Ḥakīm (ṭ2) mnqqaḥh 1427h 2006m.
- Syyid al-Qimnī / antikāstu almuslmyn ilā alwthnyyah, altaashkhyṣu qbla al’slāḥ / Mu‘assasat al-Intishār al-‘Arabī (Ṭ1) 1430h2010m.
- D. ‘Alī Sharī‘atī / dynun ḍdda alddīn / alddār al-‘Ālamīyah (Ṭ1) 1404h 1984m.
- Abū al-Ḥasan ‘Alī al-Ḥasanī alnnaḍwy / mādhā khasra al‘ālmū bānḥṭāti almuslmyn / Dār al-Salām lil-Ṭibā‘ah wa al-Nashr (ṭ11) 1398h1978m.
- Mḥmmad al-Ḥusayn Āl Kāshif al-Ghiṭā’ / aṣlu alshshy‘ti w’sūluḥā / taḥqīq ‘Alā’ Āl Ja‘far (Qum) Īrān Mu‘assasat al-Imām al-Ṣādiq (Ṭ1) 1414h 1994m.
- Alnnaḍwy abwālḥsn / attiṣālu alttārykhi al-Islāmī wālttajdydu fī al’slām wsrruh / (D. N) (D. t) (Ṭ1).
- al-Māwardī Abū al-Ḥasan ‘Alī ibn Muḥammad ibn Ḥabīb / adbu alddīn wālddunyā / Dār alṣṣaḥābh lil-Turāth Ṭanṭā Miṣr ta‘līq Abū Ḥudhayfah Ibrāhīm ibn Muḥammad (Ṭ1) 1410h 1990m.

ملاحظة مهمة : البحث مستل من المباحث التالية :

__ محاربة الاستبداد والاستعباد والتطرف وإحقاق العدالة الربانية .

__ القضاء على الجهل وأدواته وإحلال العلم النافع والمعرفة .

__ انطفاء القوة العقلية وتسلب الأوهام والخرافات على المنظومة العلمية منها والعامّة (التعمم)

__ استعداد النفس على العقل .

__ التغريب في مفاصل حياة المسلمين .

__ انعدام الحسّ الإنسانيّ الموجب للرحمة الإلهية للبشرية .

- انعدام الحسّ الإنسانيّ والتّزوُّع إلى العُدوانية والإفتراس .
— براءة خاتم الأنبياء والمرسلين ρ من المشركين/دوافعها ونتائجها ووجه الرّبط بين سورة الأنفالِ وسورة التّوبة .



UNIVERSITI

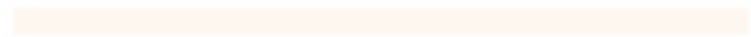

MALAYSIA

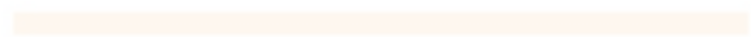

KELANTAN

القيم الإسلامية وأثرها في بناء الفرد والمجتمع

عبد العزيز أبوبكر عفت

ملخص البحث

هدفت هذه الدراسة إلى بيان المقصود من القيم الإسلامية مع توضيح وجهات نظر الباحثين والمفكرين والكشف عن أهمية القيم الإسلامية في بناء شخصية الفرد المسلم وتحديد أهدافه في حياته وفي المحافظة على تماسك المجتمع ووحدته واستقراره، وأن الحفاظ على القيم الإسلامية يتم بتوحيد جهود كافة المؤسسات، وبيان أثر القيم الإسلامية في بناء الفرد والمجتمع، وخاصة عند ظهور عادات وتقاليد تخالف الدين الإسلامي، والتي تؤثر في الحضارة الإسلامية والبيئة التي يعيش فيها الفرد والمجتمع كارتفاع معدلات الجريمة وكثرة العقوق الذي يصل في بعض الأحيان إلى القتل، كل ذلك وغيره يشير إشارات واضحة إلى تدني منظومة الأخلاق والقيم، واعتمدت الدراسة على المنهج الوصفي القائم على الاستنباط وتحليل آراء الباحثين والدارسين والمفسرين في تناولهم للقيم الإسلامية والاستدلال بالنصوص القرآنية والأحاديث النبوية، وتوصلت الدراسة إلى أن القيم الإسلامية لها أثر كبير في النهوض بالأمة الإسلامية وأن الحفاظ عليها يزيد من وحدة المجتمع الإسلامي وترابطه، وأن القيم الإسلامية تحافظ على معاني الحضارة الإسلامية وتراثها وتحقق الأهداف التي جاء بها الدين الإسلامي وكذلك السعادة للفرد والمجتمع في الدارين، وأنه كلما انتشر الفساد وازداد معدل الجريمة انهارت منظومة القيم الإسلامية وتباعد الفرد والمجتمع ككل عن الدين الإسلامي ويعم الظلام في الأرض ويفقد الفرد والمجتمع لأهم القيم الإسلامية.

مقدمة:

إن الحمد لله، نحمده ونستعينه ونستغفره ونتوب إليه، ونعوذ بالله من شرور أنفسنا وسيئات أعمالنا، من يهده الله فلا مضل له ومن يضلل فلا هادي له، وأشهد أن لا إله إلا الله وحده لا شريك له، وأشهد أن محمداً عبده ورسوله فإنه من أشرف خلق الله خلقاً وخلقاً، وخلق الإنسان يصبح عظيماً بالقدر الذي يعمل فيه من أجل اظهار الحق وإبطال الباطل وإعلاء كلمة الله والخوف منه في السر والعلن، ويمارس القيم الإسلامية ويعززها في نفسه وعند الآخرين، ويكون قدوة فعالة لها أثرها الجميل في بناء جيل مثقف إسلامياً ويغرس مبدأ التسامح والعفو عند المقدرة والتعاون في سبيل تحقيق الهدف المنشود من الحياة على وجه الأرض قال تعالى " وَمَا خَلَقْتُ الْجِنَّ وَالْإِنْسَ إِلَّا لِيَعْبُدُونِ " سورة الذاريات، الآية 56، وقال تعالى أيضا " وَتَعَاوَنُوا عَلَى الْبِرِّ وَالتَّقْوَىٰ ۖ وَلَا تَعَاوَنُوا عَلَى الْإِثْمِ وَالْعُدْوَانِ ۗ وَاتَّقُوا اللَّهَ ۖ إِنَّ اللَّهَ شَدِيدُ الْعِقَابِ " سورة المائدة، الآية 2.

فلا معنى لحياة الأفراد بلا قيم تحكم سلوكهم وتحدد مسارات تفكيره خاصة بعد انتشار العديد من الآفات والسلوكيات والظواهر السلبية، فلقد أصبح لزاماً علينا كتربيين وصناع قرار أن نعيد توجيه أسس منظومة التعليم بالتركيز والاهتمام في غرس وتعليم القيم الإسلامية من خلال مصادر التعليم المدرسي ومؤسسات المجتمع بهدف وضع رؤية تعاونية مشتركة تهدف إلى إعادة توجيه سلوك الأفراد والمجتمع التوجيه الأخلاقي وتعديل المعايير التربوية والاحترام لديهم (الجسار، 2009).

فهذا فإن تعزيز القيم الإسلامية لدى البشرية ضرورة لا مفر منها ولا بديل عنها لأن ذلك من الممارسات اليومية في حياة الإنسان، فيجب أن يضبط سلوكه بما يتماشى مع ديننا الإسلامي، وبناء الفرد والمجتمع على أسس سليمة وصحيحة وذلك عن طريق تعزيز وترسيخ القيم الإسلامية وتنميتها (الفهداوي، 2009).

فإن من أسباب ضعف القيم الإسلامية هو ضعف الإيمان، فالقلوب تتأثر بالمعصية وتتأثر بالطاعة، فكلما تقرب العبد إلى الله سبحانه وتعالى في السراء والضراء واعتاد ممارسة العمل الصالح وابتعد عن المعاصي صلح قلبه وسلوكه وكثرت، وأن كثرة المعاصي والفسوق والعصيان تقسي القلب وتبعد العبد عن طريق الحق وتؤثر في سلوكه ومعاملته، ويختم الله على قلبه، قال تعالى: " حَتَّمَ اللَّهُ عَلَى قُلُوبِهِمْ " سورة البقرة، الآية 7، وقال تعالى " فَلَمَّا زَاغُوا أَزَاغَ اللَّهُ قُلُوبَهُمْ " سورة الصف، الآية 5.

وإن هذه التغيرات والتطورات السريعة في العصر الحديث تعتبر بمثابة تحديات انعكست على القيم الإسلامية للفرد والمجتمع، ويستوي في ذلك الدول المتقدمة والدول النامية، بحيث أصبحت تربية الفرد في هذا العصر الذي يتميز بسرعة التغيير، أمر بالغ الصعوبة على التربويين وصناع القرار أن يضعوا خطة تربوية صالحة لكل الأفراد، وذلك في جو ومناخ ملئ بالصراع بين قيم متضادة وليست متكاملة، وفي مناخ تسوده قيم غير ثابتة سريعة التحول متعددة الاتجاهات ترتبط بالصراع على السلطة والثروة، وزيادة قيمة الاستهلاك وبث قيم الخضوع والاستسلام للغير وغيرها (ابن دهب، 1421 هـ).

ولعل هذا ما يجعل التربية الحديثة الآن تواجه قضية هامة وخطيرة وهي قضية تعليم القيم، فهناك العديد من الآراء والحوارات التي تتطلب الاهتمام بالقيم باعتبارها أساس وجوهر الوجود البشري خاصة بعد فقدان سيطرت الماديات والرفاهية، على حياة الأفراد فأصبحت توجه ممارستهم اليومية مما أدى إلى تفشي العديد من السلوكيات السلبية في المجتمع، فنحن اليوم بحاجة إلى الاهتمام بتعديل السلوك الإنساني وترسيخ القيم الإسلامية لدى الفرد والمجتمع، وتصبح التربية الإسلامية من أحد أهم المصادر الرئيسية التي تضم مفاهيم وعناصر القيم فلا معنى لحياة الأفراد بلا قيم تحكم سلوكهم وأخلاقهم خاصة بعد انتشار العديد من الجرائم والسلوكيات والظواهر السلبية، لقد أصبح لزاماً علينا كتربويين وصناع قرار أن نعيد توجيه أسس منظومة التربية والتعليم بالتركيز والاهتمام لغرس القيم الإسلامية وتعليمها من خلال التعليم المدرسي وغيرها من مؤسسات المجتمع بهدف وضع روابط تعاونية مشتركة تهدف إلى إعادة توجيه سلوك الإنسان الأخلاقي (الجسار، 2009).

والقيم الإسلامية كثيرة ومتعددة الأهداف منها: الحياء، الأمانة، الصدق، الصبر، الرحمة، العدل، الاعتدال، التواضع، العفو، الأخوة، عزة النفس، النزاهة، القناعة، العفة، الاستعلاء على الهوى والشهوات. والعمل بهذه الأخلاق الكريمة وتفعيلها والعناية بها في محيط المؤسسات التربوية والتعليمي، وكفيل بمشيئة الله أن يجعل من الفرد والمجتمع سداً منيعاً لمواجهة تحديات المؤامرات الدولية، ويحافظ على مبادئ الأسرة وأهدافها (الدعدي، 1431).

مشكلة البحث:

تتمثل مشكلة البحث في عزوف الناس عن القيام بما أحله الله سبحانه وتعالى والابتعاد عن الدين الإسلامي الحنيف، مما يؤدي إلى الكثير من الممارسات الغير مرغوب فيها والتي تتناقى مع ديننا الإسلامي الحنيف وأخلاق وقيم المسلمين، فزيادة سلوك المنحرفين بصور ومظاهر عديدة يؤثر على الفرد والمجتمع وله عواقب غير محمودة.

ولعل ما يجعل التربية الإسلامية ضرورة هامة من ضروريات الحياة في هذا الوقت أكثر من أي وقت مضى، وذلك لتردي القيم الإسلامية لدى الأفراد والمجتمعات، سواء على الصعيد العالمي حيث الانحلال الخلقي وكثرة الفسوق والعصيان وانتشار الجريمة والفساد الخلقي وضعف الضمير الإنساني وتغليب المصلحة الخاصة على المصلحة العامة، وتمكن القوي من الضعيف، وأما على

الصعيد العربي والإسلامي حيث اهتزاز القيم الإسلامية واضطراب المعايير الاجتماعية والأخلاقية والتمرد في بعض الأحيان على تعاليم الدين الإسلامي ومحاولة البعض ممن استهوتهم الحياة المادية من إصااق التهم للعقيدة الإسلامية واتهامها بتهم باطلة (الهندي، 2001).

وأن هذه التغيرات لها تأثير مباشر على الفرد والمجتمع، وتترك بصماتها على شخصيته، سواء كانت أخلاقية أو تربوية أو اجتماعية أو اقتصادية أو ثقافية وغيرها، الأمر الذي انعكس بالضرورة على القيم الإسلامية للفرد بصفة خاصة وللمجتمع بصفة عامة، حيث أدت هذه التغيرات إلى عدم مقدرة عدد كبير من أفراد المجتمع وبخاصة الشباب على التمييز بين ما هو مقلول وما هو غير مقبول، وعلى هذا ضعفت مقدرتهم على الانتقاء والاختيار من بين القيم المتصارعة الموجودة بين أفراد المجتمع، وعجزوا عن تطبيق ما قد يؤمنون به من قيم، وهذا ما سبب لهم أزمة قيمية (إبراهيم، 2004).

وكذلك ما تعيشه الأمة الإسلامية في حياتها المعاصرة من مشكلات وضعف لا يمثل خطراً عادياً، بل هو خطر كبير ينبغي لكل عاقل أن يتنبه له ويأخذ الحذر منه، فما نشاهده اليوم وما نسمع عنه في كثير من البلاد عموماً، والبلاد الإسلامية خصوصاً من ارتفاع معدلات الجريمة وكثرة الفساد والانحرافات والفسوق والعصيان والعقوق الذي يصل في بعض الأحيان إلى القتل، كل ذلك وغيره يشير إشارات واضحة إلى تدني منظومة الأخلاق والقيم، وخاصة في زمن العولمة والانفتاح على الغرب (الشنقيطي، 1429).

إن التناقض والتصادم في القيم والمعايير الإسلامية والأخلاقية التي تحكم الفرد تحدث خلل في المنظومة القيمية لديه، مما يؤدي في النهاية إلى انحرافه وتطرفه، لذلك يقع على الإداريين والأكاديميين في المؤسسات التربوية مسؤولية كبيرة باعتبارهم قدوة صالحة لطلابهم (سناري، 2008)، ويقول الورفلي (2009) إن مجتمعنا الإسلامي المحافظ على القيم والأخلاق والكرم وكل الصفات الحميدة والنبيلة، والتي أصبحت شبه مندثرة في المجتمع الآن، وذلك لتفشي عدة ظواهر سلبية في المجتمع منها ظاهرة المعاكسات والألفاظ البذيئة التي يتلفظ بها الشباب، هذا المجتمع الذي أصبحت احدي سماته هذه الظواهر السلبية ومما يجرح القلب أن هذه الظواهر تمارس في الأماكن المقدسة من المدارس والجامعات.

فيعيش العالم اليوم ثورة ثقافية وعلمية هائلة، وسيزيد حجمها وتأثيرها خلال الفترة القادمة من الزمن، وسيكون لها تأثير على الفرد والمجتمع من النواحي الفكرية والاجتماعية والسياسية على مختلف العالم، وبالتالي فإن تشكيل النظام العالمي سيتوقف على منجزات هذه الثورة العلمية والتكنولوجية التي تندفق الآن بشدة (عناد وآخرون، 1998).

ومن هنا يتضح لنا أن القيم الإسلامية ضرورة هامة لا يمكن الاستغناء عنها في بناء الفرد والمجتمع، وأن ما نلاحظه من تدهور في المنظومة القيمية لدى الأفراد والمجتمعات، وذلك عن طريق تفاقم القيم السلبية وكثرة انتشارها في هذا الزمن، وكذلك زيادا الانحلال الخلقي، وجب علينا كتربويين أن نعرف معنى القيم الإسلامية وتوضح أهميتها بالأدلة من الكتاب والسنة، وكذلك توضيح آثارها على الفرد والمجتمع.

أهداف البحث:

- بيان المقصود من القيم الإسلامية.

- الكشف عن أهمية القيم الإسلامية في بناء شخصية الفرد والمجتمع.
- بيان أثر القيم الإسلامية في بناء الفرد والمجتمع.

أهمية البحث:

إن أهمية دراسة القيم الإسلامية وأثرها في بناء الفرد والمجتمع ذو أهمية بالغة في هذه الحياة، وجزء أساسي لا يمكن الاستغناء عنه في مجال التربية والتعليم، وكذلك أن العالم الإسلامي اليوم يشهد تغيرات كبيرة في النسق القيمي وتدهور في بعض القيم الإسلامية لدى الأفراد والمجتمع ككل، فرأى الباحث أن الأمر يتطلب دراسات وبحوث لتناول موضوعات القيم الإسلامية لعله يستفيد منه الباحثون والدارسون في هذا المجال، ليضعوا له أهمية للنهوض بالأجيال القادمة والمحافظة على القيم الإسلامية وبيان أهميتها للفرد والمجتمع، وتوضيح أثر القيم الإسلامية في بناء الفرد والمجتمع عند التزامهم بالقيم، وأن الأولوية الكبرى في النهوض بالفرد والمجتمع وخاصة في هذا المجال هم الأسرة والمؤسسات التربوية والتعليمية.

فيقول الحق (2012) أن تدريس القيم في المؤسسات التربوية والتعليمية له أهمية قصوى لا يمكن إنكاره، فالمؤسسات التربوية والتعليمية هي المركز الرئيسي والأصلي لتربية الأفراد، فإن الأولاد منذ نعومة أظفارهم يتعلمون الأخلاق والقيم الإسلامية من أسرهم ومعلميهم، فإذا كان الأولاد لم يتعلموا الأخلاق النبيلة والقيم الإسلامية من أولياء أمورهم ومعلميهم داخل أسوار مدارسهم، فإنهم في المستقبل سوف يكونون أسبابا للشر والفساد في المجتمع، فروضة المدرسة أحسن مركز لممارسة الطلاب والطالبات على العادات والتقاليد الطيبة، فإنهم يتعودون على الأعمال الخيرية منذ الصغر، وإذا وضعت المناهج الدراسية في المؤسسات العلمية وفق القرآن الكريم والسنة النبوية والعقيدة السليمة والتوجيهات النبوية، فإنها تساعد على بناء أجيال طيبة وعريقة، وفي المقابل إذا كانت المقررات الدراسية لم توضع وفق المنهج الشرعي فإن الطلاب ينشؤون بلا قيم ولا أخلاق، ولا شك أن الإنسان ليس له قيمة إذا كان عديم الأخلاق والقيم، قال تعالى: (أَقْرَأْ بِاسْمِ رَبِّكَ الَّذِي خَلَقَ - خَلَقَ الْإِنْسَانَ مِنْ عَلَقٍ) سورة العلق، الآية 1-2.

منهجية البحث:

يقوم هذا البحث على المسح التحليلي الوصفي المكتبي للرؤية الإسلامية في مفهوم القيم الإسلامية وأهميته في بناء شخصية الفرد والمجتمع وأثرها في الفرد والمجتمع، والتي تطرقت إليها بعض الدراسات والأبحاث السابقة بشكل مباشر أو غير مباشر، من خلال رؤية إسلامية للقيم وأهميتها وأثرها وذلك لمواجهة التحديات المستقبلية.

المبحث الأول

تعريف القيم:

تعرف بأنها "مجموعة من المعايير التي تحقق الاطمئنان للحاجات الإنسانية ويحكم عليها الناس بأنها حسنة، ويكافحون لتقديمها إلى الأجيال القادمة، ويحرصون على الإبقاء عليها" (عبد الكافي، 2005).
وتعرف القيم بأنها مقاييس يحكم بها على الأفكار أو السلوك أو الأعمال أو المواقف من حيث حسنيتها وقبولها أو سوءها ورفضها (القادري وأبو شريح، 2005).

وأما القيم الإسلامية فلها طبيعة مميزة منفردة، تؤثر على الفرد والمجتمع، فيعرفها بالجن (1406) على أنها عبارة عن مفاهيم تدل على مجموعة من المعايير التي تتكون لدى الفرد من خلال تفاعله الاجتماعي مع المواقف والخبرات التي يشترك فيها مع الجماعة، ولذلك فأها تُكتسب من المجتمع وتنتقل إلى الأفراد.

ويعرفها الجلال (2007) "مجموعة من المعتقدات والتصورات المعرفية والوجدانية والسلوكية الراسخة يختارها الإنسان بحرية بعد تفكير وتأمل، ويعتقد بها اعتقاداً جازماً، تشكل لديه منظومة من المعايير يحكم بها على الأشياء بالحسن أو القبح، وبالقبول أو الرد، ويصدر عنها سلوك منتظم يتميز بالتكرار والثبات والاعتزاز".

فالقيم الإسلامية هي: مجموعة من المعايير والأحكام النابعة من تصورات أساسية عن الكون والحياة والإنسان، كما صورها الإسلام، وتتكون لدى الفرد والمجتمع من خلال التفاعل مع المواقف والخبرات الحياتية المختلفة، بحيث تمكنه من اختيار أهداف وتوجهات حياته تتفق مع إمكانياته، وتتجسد من خلال الاهتمامات أو السلوك العملي بطريقة مباشرة وغير مباشرة (مصطفى، 1980).

فالقيم الإسلامية في الإسلام مؤثرة بشكل كبير على القيم الأخرى، فالقيم السياسية تؤسس على القيم الإسلامية، والنظم التعليمية تعكس القيم الدينية والإسلامية، والحياة في الأسرة محكومة بالشرعية الإسلامية، والأخلاق في أساسها مستمدة من الأخلاق الإسلامية، وبالتالي نشاطات المسلم جميعها تعكس القيم الإسلامية (بيومي، 2002).

وتتبع القيم الإسلامية من العقيدة الإسلامية أساساً، وليس عن المصلحة المؤقتة، أو المنفعة الذاتية، ولكن لما كانت القيم الإسلامية تعتمد على أصل الشعور بما عند الإنسان، فتحتضن تلك القيم بحيث وترجمها إلى صورة أفعال أو انفعال أو لفظ، فإن الإسلام يجعل الأساس الذي تقوم عليه كافة القيم الإسلامية للإنسان الذي يعتبر محور الرسالة عبداً لله، وتحقق تلك القيم كرامة الإنسان، بمراعاة طبيعته وطاقاته وقدراته، وما سُخر له من طاقات الكون، وبما أنزل عليه من هداية الوحي، وبذلك تحققت كرامة الإنسان، وتحياً له أن يضع ويدع في ظل هذه القيم، بل كانت الدافع للصُّنع والإبداع، والحركة الدائبة في كافة الاتجاهات (علي، 2006)

المبحث الثاني

أهمية القيم الإسلامية

يهتم الإسلام اهتماماً بالغاً بالقيم الإسلامية، ويتمثل ذلك بدعوة المسلمين في أكثر من موضع في القرآن الكريم وفي أحاديث النبي صلى الله عليه وسلم، فهي تعتبر موجهة لسلوك الفرد داخل المجتمع المسلم وتضبط تصرفاته وعمله وسلوكه لكي يعيش حياة سعيدة في الدنيا ويستريح في حياة الآخرة.

أهمية القيم الإسلامية للفرد:

- تحفظ الإنسان من الانحراف وتحفظه من أن يكون عبداً لغرائزه وشهواته وأهوائه (الجلاد، 2007).
- تعمل القيم الإسلامية على تكوين روح الخير لدى الفرد والمجتمع، حيث يلتزم بالخير ويتجنب سلوك الشر (الجن، 2002)
- تمثل القيم الإسلامية ميزان الإسلام، وثمره العبادات بأجمعها، فالدين معاملة، وأقرب الناس إلى الله سبحانه وتعالى أحسنهم أخلاقاً (المسير، 2001)

- لها دور فعال في تحقيق التوافق النفسي والاجتماعي للأفراد داخل المجتمع الواحد، كما لها دورا مهما في عمليات الإرشاد والتوجيه الذي يهدف إلى تعديل السلوك (سلوت، 2005)
- ويضيف المرزوق 2007 أن من أهمية القيم للفرد:
- تحقق للفرد الإحساس بالأمان وتعطي له الفرصة للتعبير عن ذاته.
- تعمل على ضبط شهوات الفرد لكي لا تتغلب عليه شهواته وينجر وراء عقله ووجدانه، فتربط سلوكه بمعايير قيمة يتصرف على ضوءها.
- تساعد الفرد في توجيهه إلى الطريق التي سيتعامل بها في المواقف المستقبلية والتفكير بإيجابية اتجاه تلك المواقف وفق أساليب ووسائل يختارها اتجاهها.
- فأهمية القيم الإسلامية تتجلى في معرفة الفرد المسلم لربه حق المعرفة، وتساعدته كذلك على بناء عقيدته والحفاظة على سلوكه من الانحراف والضياع وراء الشهوات والمغريات، فهي توجه الفرد إلى فعل الخيرات واتقان العمل وأداء العبادات على أكمل وجه، فالقيم الإسلامية لها ثقل في حياة الفرد إذا عمل بها وأتقنها ترفع من شأنه في الدنيا والآخرة، ويفوز الفرد وترفع درجاته بالجنان وتبعده عن النار والعباد بالله من شرورها، فيجب على كل فرد من أفراد المجتمع المسلم أن يحافظ عليها وأن يؤدي ما أمر الله سبحانه وتعالى به ويجتنب كل ما نهى عنه من المعاصي والمنكرات وغيرها من الرذائل والمهلكات.
- أهمية القيم للمجتمع:
- إن أهمية القيم الإسلامية للمجتمع فهي تحفظ تماسكه وترابطه وتحدد له أهدافه وغاياته ومثله العليا في إطار موحد في الحياة، فالمجتمع هو الرابط بين أفرادها في بناء وحدتهم وقوتهم، والنهوض بأي مجتمع يعتمد على الأفراد فإذا تم التعاون بينهم في السراء والضراء وفي استمرار العمل في الحياة من خلال القيام بالقيم الإسلامية، فسيعيش مجتمعا سليما معاف خال من الشوائب والمشاكل.
- ويضيف المرزوق (2008) أنه لا حياة لنا إذا اهدرت قيمنا الإسلامية أو غابت علينا أو سحقت كرامة الإنسان وانتهكت حقوقه، فإن الحفاظ على قيمنا الإسلامية هي صمام الأمان والأمن لاستمرار في الحياة السعيدة، وأن التغيير لن يحدث إلا من داخل الإنسان وذلك من خلال النهوض بالقيم النبيلة والارتقاء بها.
- أن القيم الإسلامية تحقق التقارب والتجانس بين أفراد المجتمع، وعن طريقها تحقق النهضة الاجتماعية القوية للمجتمع (يالجن، 2002).
- تجعل الأفراد داخل المجتمع الواحد يطمئن في تعامله مع من يتعامل ويتعاون معهم، فلا يخشى غدرا ولا خيانة ولا غشا ولا تزويرا فتعم الثقة داخل أفراد المجتمع (الأسمر، 1997).
- القيم الإسلامية تزود أفراد المجتمع بمعنى الحياة السعيدة، وذلك لاستخدامها كمعايير يقاس بها العمل ويقوم بها السلوك الإنساني (المزيني، 2001).
- القيم الإسلامية تساعد المجتمع على مواجهة تغيرات المستقبل التي تحدث فيه بتحديد الاختبارات السليمة التي تُسهل لأفراد المجتمع حياتهم وتحفظ للمجتمع استقراره وكيانه في إطار مجتمعي واحد (عبد الغفور، 1982).
- "تساعد على التنبؤ بما ستكون عليه المجتمعات، فالقيم والأخلاقيات الحميدة هي الركيزة الأساسية التي تقوم عليها الحضارات، وبالتالي فهي تعد مؤشرات الحضارة، فالمجتمع الذي يحمل قيما وأخلاقيات مجتمع يتنبأ له بحضارة ورفي وازدهار، وإذا ما انحارت تلك الأخلاقيات سقطت الحضارة وأصبحت الأمم في طريقها إلى التخلف" (المرزوق، 2008).
- تساعد المجتمع على مواجهة التحديات والتغيرات التي تطرأ عليه، والتي تسهل على الناس حياتهم، وتحفظ للمجتمع استقراره وكيانه في إطار واحد.

- القيم الإسلامية تقوي العلاقات والروابط الأسرية داخل أفراد المجتمع، وتنظم شؤون حياتهم تحت مظلة الاحترام والتعاون والتألف وغيرها من القيم الإسلامية.

ومن أهمية القيم الإسلامية أنها تساعد في رسم الطريق السليم للفرد والمجتمع في تعاملهم وسلوكهم والتي استفاد بها القرآن الكريم والسنة النبوية الطاهرة ومن تلك الآيات والأحاديث التي جمعت بين التربية والقيم والأخلاق الإسلامية، فمن النصائح والمواظب التي تم ذكرها في القرآن الكريم نذكر من ذلك قول الله تعالى (إِنَّ اللَّهَ يَأْمُرُ بِالْعَدْلِ وَالْإِحْسَانِ وَإِيتَاءِ ذِي الْقُرْبَىٰ وَيَنْهَىٰ عَنِ الْفَحْشَاءِ وَالْمُنْكَرِ وَالْبَغْيِ ۗ يَعِظُكُمْ لَعَلَّكُمْ تَذَكَّرُونَ) سورة النحل، الآية 90.

واستخدم القرآن الكريم القصة للاعتبار والاتعاظ من قصص السابقين وكذلك لنشر الدين الإسلامي وهدفها تعميق القيم الإسلامية قال تعالى (لَقَدْ كَانَ فِي قَصَصِهِمْ عِبْرَةٌ لِأُولِي الْأَلْبَابِ ۗ مَا كَانَ حَدِيثًا يُفْتَرَىٰ وَلَكِن تَصْدِيقَ الَّذِي بَيْنَ يَدَيْهِ وَتَفْصِيلَ كُلِّ شَيْءٍ وَهُدًى وَرَحْمَةً لِّقَوْمٍ يُؤْمِنُونَ) سورة يوسف، الآية 111. وقال تعالى أيضا (وَكَلَّا نَقُصُّ عَلَيْكَ مِنْ أَنْبَاءِ الرُّسُلِ مَا نُثَبِّتُ بِهِ فُؤَادَكَ ۗ وَجَاءَكَ فِي هَذِهِ الْحَقُّ وَمَوْعِظَةٌ وَذِكْرَىٰ لِلْمُؤْمِنِينَ) سورة هود، الآية 120.

ولا يمكن للقيم الإسلامية أن ترسخ في النفس البشرية دون أن تعتاد على ذلك وممارسة العمل الصالح والابتعاد عن السيئ من الأفعال فيقول الله عز وجل مادحا الذين يمارسون القيم الإسلامية قال تعالى: (الَّذِينَ يَسْتَمْعُونَ الْقَوْلَ فَيَتَّبِعُونَ أَحْسَنَهُ ۗ أُولَٰئِكَ الَّذِينَ هَدَاهُمُ اللَّهُ ۖ وَأُولَٰئِكَ هُمْ أُولُو الْأَلْبَابِ) سورة الزمر، الآية 18. وفي حديث رسول الله صلى الله عليه وسلم الذي يرويه بن ماجه (الخير عادة والشر لجاجة، ومن يرد الله به خيرا يفقهه في الدين).

وقد ذكر في القرآن الكريم الثواب في العديد من المواضع لترغيب المؤمنين في عبادته واتباع أوامره قال تعالى (وَبَشِّرِ الَّذِينَ آمَنُوا وَعَمِلُوا الصَّالِحَاتِ أَنَّ لَهُمْ جَنَّاتٍ تَجْرِي مِنْ تَحْتِهَا الْأَنْهَارُ ۖ كُلَّمَا رُزِقُوا مِنْهَا مِنْ ثَمَرَةٍ رِزْقًا ۖ قَالُوا هَذَا الَّذِي رُزِقْنَا مِنْ قَبْلُ ۖ وَأُتُوا بِهِ مُتَشَابِهًا ۖ وَلَهُمْ فِيهَا أَزْوَاجٌ مُطَهَّرَةٌ ۖ وَهُمْ فِيهَا خَالِدُونَ) سورة البقرة، الآية 25. وعن أبي هريرة رضي الله عنه، قَالَ رَسُولُ اللَّهِ ﷺ: (حَقُّ الْمُسْلِمِ عَلَى الْمُسْلِمِ سِتٌّ: إِذَا لَقِيْتَهُ فَسَلِّمْ عَلَيْهِ، وَإِذَا دَعَاكَ فَاجِبْهُ، وَإِذَا اسْتَنْصَحَكَ فَانصَحْهُ، وَإِذَا عَطَسَ فَحَمِدِ اللَّهَ فَسَمِّتْهُ، وَإِذَا مَرَضَ فَعُدَّهُ، وَإِذَا مَاتَ فَاتَّبِعْهُ). رواه مسلم.

كما وعد المخالفين والمنافقين وذلك كعقوبة لمن يخالف أمره قال تعالى: (الَّذِينَ كَذَّبُوا بِالْكِتَابِ وَمَا أُنزِلْنَا بِهِ رُسُلَنَا ۖ فَسَوْفَ يَعْلَمُونَ (70) إِذِ الْأَعْلَالُ فِي أَعْنَاقِهِمْ وَالسَّلَاسِلُ يُسْحَبُونَ (71) فِي الْحَمِيمِ ثُمَّ فِي النَّارِ يُسْجَرُونَ) سورة غافر، الآية 70-72. وقال تعالى أيضا (وَلَا تُطْعَمَنْ مِنْ أَعْفُنَا فَكَبُهُ عَنْ ذِكْرِنَا وَاتَّبَعَ هَوَاهُ وَكَانَ أَمْرُهُ فُرُطًا) سورة الكهف، الآية 28. وقال تعالى أيضا في سورة الفرقان (وَيَوْمَ يَعْزُضُ الظَّالِمُ عَلَىٰ يَدَيْهِ يَقُولُ يَا لَيْتَنِي اتَّخَذْتُ مَعَ الرَّسُولِ سَبِيلًا (27) يَا وَيْلَتَىٰ لَيْتَنِي لَمْ أَتَّخِذْ فُلَانًا خَلِيلًا (28) لَقَدْ أَضَلَّنِي عَنِ الذِّكْرِ بَعْدَ إِذْ جَاءَنِي ۗ وَكَانَ الشَّيْطَانُ لِلْإِنْسَانِ خَذُولًا) سورة الفرقان، الآية 27-29.

وفي تربية الأولاد والأهل تربية سليمة على التقوى والالتزام بأوامره واجتناب نواهيه قال تعالى (يَا أَيُّهَا الَّذِينَ آمَنُوا قُوا أَنْفُسَكُمْ وَأَهْلِيكُمْ نَارًا وَقُودُهَا النَّاسُ وَالْحِجَارَةُ عَلَيْهَا مَلَائِكَةٌ غِلَاظٌ شِدَادٌ لَا يَعْصُونَ اللَّهَ مَا أَمَرَهُمْ وَيَفْعَلُونَ مَا يُؤْمَرُونَ) سورة التحريم، الآية 6. وجعل الرسول صلى الله عليه وسلم مسؤولية رعاية الأولاد على الوالدين وطالبتهم بذلك: فعن عبد الله بن عمر رضي الله تعالى عنهما قال: سمعت رسول الله صلى الله عليه وسلم يقول: «كلكم راع وكلكم مسئول عن رعيته الإمام راع ومسئول عن رعيته والرجل راع في أهله وهو مسئول عن رعيته والمرأة راعية في بيت زوجها ومسئولة عن رعيته والخادم راع في مال سيده ومسئول عن رعيته قال وحسبت أن قد قال والرجل راع في مال أبيه ومسئول عن رعيته وكلكم راع ومسئول عن رعيته». رواه البخاري ومسلم. وفي ديننا الإسلامي نجد فضيلة العدل والإحسان مثلاً في قوله تعالى (إِنَّ اللَّهَ يَأْمُرُ بِالْعَدْلِ وَالْإِحْسَانِ وَإِيتَاءِ ذِي الْقُرْبَىٰ وَيَنْهَىٰ عَنِ الْفَحْشَاءِ وَالْمُنْكَرِ وَالْبَغْيِ ۗ يَعِظُكُمْ لَعَلَّكُمْ تَذَكَّرُونَ) سورة النحل، الآية 90، وأوصى عز وجل بالأمانة (إِنَّ اللَّهَ يَأْمُرُكُمْ أَنْ تُؤَدُّوا الْأَمَانَاتِ إِلَىٰ أَهْلِهَا وَإِذَا حَكَمْتُمْ بَيْنَ النَّاسِ أَنْ تَحْكُمُوا بِالْعَدْلِ ۗ إِنَّ اللَّهَ نِعِمَّا يَعِظُكُمْ بِهِ ۗ إِنَّ اللَّهَ كَانَ سَمِيعًا بَصِيرًا) سورة

النساء، الآية 58، وفي فضيلة التعاون يقول عز وجل (وَتَعَاوَنُوا عَلَى الْبِرِّ وَالتَّقْوَىٰ ۖ وَلَا تَعَاوَنُوا عَلَى الْإِثْمِ وَالْعُدْوَانِ ۗ وَاتَّقُوا اللَّهَ ۖ إِنَّ اللَّهَ شَدِيدُ الْعِقَابِ) سورة المائدة، الآية 2.

وأضافت السنة النبوية الكثير من الفضائل ولا غرابة في ذلك فالرسول الكريم إنما بعث ليتمم مكارم الأخلاق، ويكفي قوله صلى الله عليه وسلم (لا يؤمن أحدكم حتى يحب لأخيه ما يحب لنفسه)، وتأخذ كلمة يكفي هنا قوتها من حقيقة أن هذا الحديث هو ما أسماه فلاسفة الأخلاق (القاعدة الذهبية) وبنوا عليها نظرياتهم.

المبحث الثالث

أثر القيم الإسلامية في بناء الفرد والمجتمع

إن بناء القيم الإسلامية والمبادئ الأخلاقية يعتبر الركن الأساسي للتربية الإسلامية، فلا تربية بدون أساس أخلاقي، فالإنسان بطبعه يحتاج إلى من يقوده ويعرفه على المبادئ الأساسية والعميقة وذلك عن طريق الممارسة والقدوة والتلقين وغيرها من الوسائل المتقدمة، فحين يتلقى الإنسان المعاملة الحسنة والاحترام والتقدير لكرامته فهو يزيد من احترامه لنفسه ولغيره وكذلك تنمية الجوانب الإنسانية لديه، فنحن بحاجة إلى ممارسة القيم الإسلامية وخاصة في هذا الوقت الذي نواجه فيه تحديات سياسية واقتصادية واجتماعية وتربوية وغيرها، ولو نظرنا إلى أسبابها لوجدناها ضعفا في القيم الإسلامية، وأن الحل الأنسب لهذه التحديات والمشاكل هو الالتزام بالقيم الإسلامية والمحافظة عليها، فغرس وتعزيز القيم الإسلامية في عقول وقلوب الأجيال أصبح من الضروريات في مجتمعاتنا اليوم لكي نواجه التحديات، وننجو من الانهيار والوقوع في الزلات والأخطاء، ونذكر في المبحث بعضا من التحديات التي ترتب على ظهورها السلوكيات السلبية فمنها الثورة الإعلامية والتي لها آثارا سلبية في هدم القيم الإسلامية، وكذلك ضعف العلاقات الاجتماعية بين الأفراد والمجتمعات، والعمولة السياسية التي تفككت الأسر والبيوت عن طريقها وغيرها من الآثار.

لقد ظهرت بعض الآثار السلبية لهذه الثورة والتي تمثلت في الهيمنة الإعلامية والاجتماعية والاقتصادية فعلى صعيد الإعلام فلقد فرض الإعلام في العالم وسهل من خلال هذه الوسائل الإعلامية المتقدمة فرض الهوية الثقافية الغربية على شعوب العالم، بالرغم من وجود الخصوصية الثقافية والإعلامية لكل مجتمع، كما أدت الهيمنة الإعلامية إلى انتشار البرامج الهدامة التي تروج لنمط الحياة الغربية، والذي يهدم الثقافة الدينية والقيم الإسلامية، الأمر الذي أصبح له تأثيره البالغ على السلوكيات والقيم الإسلامية (الجندي، 1999)، وكما نتج عن هذه التقنية الحديثة العديد من المخاطر والتحديات والتي أثرت على القيم الإسلامية، فالتقنية فهي سلاح ذو حدين فمنها ما هم نافع ومنها ما هو ضار ومن وجهة نظر الباحث الضرر أكثر من الصالح. وذلك من خلال كثرة المواقع المختلفة التي تبعث برسائل ومضامين تحمل قيماً لا تتفق مع ديننا الإسلام.

وإن اضعاف العلاقات الاجتماعية، وضعف الانتماء للوطن، وتحويل كل شيء في الحياة إلى سلعة تباع وتشترى على حساب القيم الإسلامية، واحلال امتلاك الثروة والربح مقام الثقافة والوعي وتحقيق الذات والثقة بالنفس، فالعمولة تهدف إلى تكوين الشخصية منفصلة عن مبادئها وقيمتها، وذلك من خلال الهيمنة الاقتصادية وفتح الأسواق واستغلال موارد وطاقت الدول النامية (عمار، 2000).

كما أن من أبرز مظاهر العمولة السياسية والتي تتمثل في الحرب على الإسلام والمسلمين مطالبة البلدان الإسلامية بإعادة نهج النظام التعليمي وخاصة في مقررات التربية الإسلامية، وإجراء تعديلات فيها مسايرة لفكر الغرب وهيمنتهم، والرغبة في التدخل لتحقيق مصالحها. كما أن التوجه الغربي لا يسمح لدولة مسلمة بأي نصيب في رسم سياسة العالم عن طريق تمثيلها بمقعد دائم في مجلس الأمن رغم أن عدد سكان العالم الإسلامي يمثل أكثر من ثلث سكان العالم تقريبا (زقروق، 1918).

فنحن اليوم بحاجة ماسة إلى ممارسة القيم الإسلامية لكي نواجه تلك التحديات التي تم ذكر البعض منها والتي تعتبر تحديات سياسية واقتصادية واجتماعية وتربوية وغيرها، ولو أمعنا النظر في أسبابها لوجدناها ضعفا في القيم الإسلامية، وأن الحل الأجدر لهذه التحديات اليوم هو الالتزام بالقول والعمل بتعاليم الدين الإسلامي وتعزيز القيم الإسلامية والمحافظة عليها من خلال تكاثف الجهود بين المؤسسات جميعا سواء كانت العلمية أو المساجد ودور العبادة ومؤسسات المجتمع ككل، فغرس وتعزيز القيم الإسلامية على مستوى الأفراد أمرا أصبح من الضروريات الحياتية لأنها تلعب دورا مهما في عقول وقلوب الأجيال، ولمواجهة التحديات على مستوى الأفراد يستلزم تفعيل منظومة القيم الإسلامية والمبادئ التي يؤمن بها الفرد لتحسين نفسه وقلبه من المغريات والتحديات، أما على مستوى المجتمع، فمنظومة القيم تحافظ على تماسك المجتمع، وتساعد على مواجهة التغيرات والتحديات المستقبلية للمجتمع، وأن تأثر المجتمع الإسلامي بالمجتمع الغربي في الفكر والثقافة، فله أثره السلبي على أفراد المجتمع، فالقيم الإسلامية تقي المجتمع من الوقوع في الشهوات والأنانية والنزاعات والإفراط والتفريط في ما نعى الله سبحانه وتعالى عنه، وينتج عنه مجتمعا له أهدافه وطموحاته من الحياة ويتمتعون بحياة يسودها الأمن والأمان.

إن للقيم الإسلامية أثارا بالغة على الفرد والمجتمع، فإذا استطعنا أن نغرس القيم الإسلامية في أفراد المسلمين يصبح مجتمعنا خاليا من الفوضى والفتن والمفاسد الكثيرة، فمن آثار القيم الإسلامية في المجتمع أنها تجعل المجتمع مجتمعا ربانيا، معياره التقوى، فالكل يتقي الله عز وجل في السر والعلانية، فلا يوجد أي فساد في المجتمع الرباني، وكذلك مجتمع خال من مشاكل العصر الحديث الإرهاب في كل مكان، فإذا كانت القيم الإسلامية سائدة في المجتمع لا نرى فيه أية عملية إرهابية، لأن الإسلام لا يشجع على الإرهاب والعنف والتعصب؛ بل الإسلام يدعو إلى السلم، مجتمع خال من الانحرافات الخلقية، فقد أثرت الجرائم والمفاسد الخلقية في المجتمع الذي نحن نعيش فيه، وذلك لأجل انحرافهم عن العقيدة السليمة والأخلاق الحميدة، فكثرت الزنا والقتل والربا والغش والرشوة وغيرها من المفاسد، فإذا كانت تعاليم الإسلام وقيمه وأخلاقه موجودة في أفراد المجتمع لرأينا أن المجتمع لا يعاني هذه المفاسد الخلقية، مجتمع يرتقي إلى القمة فالمسلمون في هذا العصر منبوذون مشردون من كل مكان، واليهود والنصارى يلعبون في كل مكان من أماكن العالم، وذلك لأجل تخلف المسلمين في العلم والمعرفة والسلوك والقيم والأخلاق، فإذا تقدم المسلمون في العلم والعمل والأخلاق والقيم لوصلوا إلى القمة لا شك فيه (الحق، 2012).

نتائج البحث:

- القيم الإسلامية لها ثقل في حياة الفرد إذا عمل بها وأتقنها فإنها ترفع من شأنه في الدنيا والآخرة، وأن القيم والأخلاقيات الحميدة هي الركيزة الأساسية التي تقوم عليها الحضارات.
- القيم الإسلامية لها أثر كبير في النهوض بالأمة الإسلامية، وأن الحفاظ عليها يزيد من وحدة المجتمع الإسلامي وترابطه.
- الحفاظ على قيمنا الإسلامية هي صمام الأمان والأمن للاستمرار في الحياة السعيدة، فتحفظ الإنسان من الانحراف وتحفظه من أن يكون عبدا لغرائزه وشهواته وأهوائه.
- تعمل على ضبط شهوات الفرد لكيلا تتغلب عليه شهواته وينجر وراء عقله ووجدانه، فتربط سلوكه بمعايير قيمة يتصرف على ضوءها
- القيم الإسلامية تحافظ على معاني الحضارة الإسلامية وتراثها وتحقق الأهداف التي جاء بها الدين الإسلامي وكذلك السعادة للفرد والمجتمع في الدارين،
- القيم الإسلامية تقوي العلاقات والروابط الأسرية داخل أفراد المجتمع.

- أنه كلما انتشر الفساد وازداد معدل الجريمة انهارت منظومة القيم الإسلامية وتباعد الفرد والمجتمع ككل عن الدين الإسلامي ويعم الظلام في الأرض ويفقد الفرد والمجتمع لأهم القيم الإسلامية.

المراجع:

- الأسمر، أحمد (1997) فلسفة التربية في الإسلام انتماء وارتقاء، دار الفرقان للنشر والتوزيع، الأردن عمان.
- ابراهيم، محمود مصطفى محمد (2004) قيم مهنة المعلم في ضوء التغيرات الاجتماعية والاقتصادية والثقافية في المجتمع المصري، رسالة ماجستير، كلية التربية، جامعة الأزهر.
- باشا، أحمد فؤاد (2003) القيم في عصر المعلومات، مجلة الأزهر، القاهرة.
- بن دهبش، خالد عبد الله (1421)، روى حول مدرسة المستقبل للبنات بالمملكة العربية السعودية ورقة عمل مقدمة لورشة العمل عن مدرسة المستقبل، الرياض، المملكة العربية السعودية.
- بيومي، محمد (2002) علم اجتماع القيم، دار المعرفة الجامعية.
- الجسار، سلوى عبد الله (2009) واقع تعلم القيم في التعليم الأساسي، رؤية جديدة نحو تطوير أداء المعلم، كلية التربية، جامعة الكويت.
- الجندي، ياسر مصطفى (1999) رؤية طلاب كلية التربية لفلسفة تكوين المعلم في ضوء تحديات القرن الحادي والعشرين، مجلة كلية التربية بنها، المجلد العاشر، العدد 31.
- الجلاد، ماجد زكي (2007) تعلم القيم وتعلمها - تصور نظري وتطبيقي لطرائق واستراتيجيات تدريس القيم، عمان، دار المسيرة.
- الحق، محمد أمين (2012) القيم الإسلامية في التعليم وآثارها على المجتمع، دراسات الجامعة الإسلامية العالمية شيتاغونغ، المجلد التاسع.
- الدعدي، عادل بن شاهر عودة (1431) التحديات التي تواجه الأسرة المسلمة في المؤتمرات الدولية دراسة ناقدة في ضوء التربية الإسلامية، رسالة ماجستير، كلية التربية، جامعة أم القرى.
- زقروق، محمود حمدي (1918) مفاتيح الحضارة وتحديات العصر قضايا إسلامية، القاهرة: المجلس الأعلى للشؤون الإسلامية.
- سناري، ربا بنت محمد جابر (2008) دور الإدارة المدرسية في ترسيخ القيم المجتمعية للوقاية من الانحراف الفكري، بحث لنيل درجة الماجستير في الإدارة التربوية والتخطيط، كلية التربية، جامعة أم القرى، المملكة العربية السعودية.
- سلوت، نور (2005) مفاهيم القيم المتضمنة في الأناشيد المقدمة لطلبة المرحلة الأساسية في مدارس فلسطين، غزة الجامعة الإسلامية كلية التربية.
- الشنقيطي، الطيب أحمد عبد الصمد (1429) الأساليب النبوية المؤدية لتنمية القيم الإيمانية لدى الشباب المسلم في ضوء التحديات المعاصرة، رسالة ماجستير كلية التربية، جامعة أم القرى.
- عبد الغفور، منصور عبد اللاه (1982) دراسة تحليلية مقارنة للقيم الدينية لدى المراهقين من طلاب التعليم العام والأزهري وأثر ذلك على مستوى القلق " كلية التربية، جامعة أسيوط.
- عبد الكافي، إسماعيل عبد الفتاح (2005) موسوعة القيم والأخلاق الإسلامية، مركز الإسكندرية للكتاب، مصر.
- علي خليل مصطفى (1980) القيم الإسلامية والتربية، بيروت: دار طيبة، الطبعة الأولى.

- علي، آمال شحاتة مصطفى (2006) القيم الأخلاقية المتضمنة في كتب التربية الدينية الإسلامية بالحلقة الثانية من التعليم الأساسي في ضوء المتغيرات العصرية، رسالة دكتوراه، كلية الدراسات الإنسانية، جامعة الأزهر.
- عمار، حامد (2000) مواجهة العولمة في التعليم والثقافة، سلسلة دراسات تربوية، العدد الثامن، القاهرة: الدار العربية للكتاب.
- عناد، وآخرون، مجذاب بدر ومحى الدين حسين (1998) المتغيرات الاقتصادية الدولية وانعكاساتها على اقتصاديات منطقة الشرق الأوسط، أكاديمية الدراسات العليا والبحوث الاقتصادية، طرابلس.
- الفهداوي، ساجدة (2009) أثر العبادة في نمط التربية الإسلامية، مجلة جامعة الأنبار للعلوم الإسلامية، العدد الثالث، المجلد الأول.
- القادري، أحمد رشيد، وأبو شريح، شاهر ذيب (2005) الفكر التربوي الإسلامي، الطبعة الأولى، دار جرير للنشر والتوزيع، عمان، الأردن.
- المرزوق، إحسان عبدالله (2008) القيم ومظاهرها السلوكية، دورة المعلمين الجدد، الطبعة الثالثة.
- المزيني، أسامة (2001) القيم الدينية وعلاقتها بالانحياز الانفعالي ومستوياته لدى طلبة الجامعة الإسلامية بغزة، غزة الجامعة الإسلامية كلية التربية.
- المسير، محمد (2001) قيم أخلاقية من القرآن والسنة، القاهرة، مكتبة الصفا.
- الهندي، سهيل أحمد (2001): دور المعلم في تنمية بعض القيم الاجتماعية لدى طلبة الصف الثاني عشر بمحافظات غزة من وجهة نظرهم، رسالة ماجستير، الجامعة الإسلامية.
- الورفلي، أحمد محمد محمد (2009) الظواهر السلبية وأثرها في المجتمع، بانوراما ليبيا، صحيفة إخبارية إلكترونية ليبية.
- ياجن، مقداد (1406) جوانب التربية الإسلامية الأساسية، بيروت، دار الفكر.

تطبيقات الذكاء الاصطناعي في اللغة العربية _ معالجة اللغة نحويًا و صرفيًا

أحمد العثمان

حكيم زينل

قسم اللغة العربية والحضارة الإسلامية

الجامعة الوطنية الماليزية، بانغي

المقدمة:

الحمد لله الذي جعل طريق العلم ميسرًا مسخرًا، ليبسط فيه طالبوه طرقهم لإفادة أنفسهم والناس من حولهم، والصلاة والسلام على نبيه الصادق الأمين محمد بن عبد الله وأهله وأصحابه ومن تبعه إلى يوم الدين، أما بعد،

إنّ الذكاء الاصطناعي علم يهدف إلى جعل الحاسوب وغيره من الآلات تكتسب صفة الذكاء وتكون لها القدرة على القيام بأعمال ما زالت إلى عهد قريب حكراً على الإنسان، وحصراً عليه، كالتفكير والتعلم والإبداع والتخاطب. (سلطاني، 2020: 512) وهو بذلك يحاول أن يفيد من الحاسوب لخدمة اللغة، وتوفير برامج وتطبيقات تستطيع القيام بمهام تفكيرية تحتاج إلى ذكاء في وقت سريع وبجهد قليل من خلال برمجة الحاسوب وما يوفره من إمكانيات في هذا المجال، عبر تطبيقات تعالج المسائل والقضايا والتساؤلات المختلفة بسهولة، وبدقة فائقة.

ولقد ظهر الذكاء الاصطناعي في خمسينيات القرن الماضي، كنتيجة للثورة التي عرفها مجال المعلوماتية والتحكم الآلي، وذلك بقصد الوصول إلى هدفين أساسيين، يتمثلان بالوصول إلى فهم عميق للذكاء الانساني قصد محاكاته. والاستغلال الأمثل للحاسوب والعمل على استثمار إمكانياته، خصوصاً بعد التطور الكبير الذي شهدته الحواسيب وتطور قدراتها. (الأسدي، 2019) (عطية وآخرون، 2019: 25). فالذكاء الاصطناعي يتعلق بالقدرة على التفكير الفائق وتحليل البيانات أكثر من تعلقه بشكل معين أو وظيفة ما، وعلى الرغم من أنه يقدم صوراً عن الروبوتات عالية الأداء الشبيهة بالإنسان التي تستطيع أن تسيطر على العالم من خلال قدرتها على تعويض الإنسان في بعض المهام التي يؤديها؛ إلا أنه لا يهدف إلى أن يحل محل البشر كما يزعم البعض؛ بل إنه يهدف إلى تعزيز القدرات والإسهامات البشرية بشكل كبير، مما يجعله ذا قيمة كبيرة. (مراد، 2020). فالذكاء الاصطناعي وظيفته أن يوفر على البشر مشاق الوصول إلى المعلومات، وتحليل البيانات بسهولة أكبر، وفي وقت أسرع، ويجعل الإنسان يتطور أو يلتفت نحو أمور أكثر أهمية، بفضل الجهود التي يوفرها الحاسوب وبرامجه وتطبيقاته، تجعله يصل إلى مراحل متقدمة وإسهامات سريعة بعد ذلك.

ومن هنا وجدنا التوجهات الحديثة، خصوصاً مع ظهور اللسانيات الحديثة؛ تتجه نحو توظيف الحاسوب وإمكانياته من أجل خدمة العلوم شتى، وقد كان ضمن ذلك باحثون ومتخصصون اهتموا بتسخير هذه الإمكانيات لخدمة اللغة العربية، من خلال تصميم برامج وتطبيقات متنوعة تخدم اللغة العربية، وتسهل على الباحثين والدارسين الوصول إلى العديد من المعلومات والبيانات بسرعة وسهولة؛ بل إنّ اللغة العربية إحدى اللغات الطبيعية التي تحظى بعناية الباحثين في الذكاء الاصطناعي عموماً ومعالجة اللغات الطبيعية على وجه الخصوص. ذلك أنّها واحدة من أكثر اللغات انتشاراً في عالمنا المعاصر؛ حيث تأتي في المرتبة الرابعة من حيث

عدد مستخدميها، بعد الصينية والأردنية-الهندي والإنجليزية. كذلك فإنها واحدة من أكثر اللغات الطبيعية تناميًا في العالم. (عطية وآخرون، 2019: 14)

مشكلة الدراسة:

إن موضوع الذكاء الاصطناعي أصبح من أبرز القضايا التي تشغل بها الدراسات اللغوية الحديثة، نظرًا لما يمتلكه من إمكانيات قادرة على صناعة فارق على مستوى التعامل مع اللغة وتيسير التعامل معها، والوصول إلى نتائج سريعة وفائقة الدقة فيما يتعلق بها، وعليه وجدنا الدراسات الحديثة تُعنى بشكل كبير بها، مبرزة الاتجاهات التي يمكن الاستفادة منها وتوظيفها لخدمة اللغة العربية.

وقد تعددت الاتجاهات البحثية التي سلكها الدارسون في توظيف الذكاء الاصطناعي للغة فمثلاً في دراسة صالح (2007) حاول الدكتور صالح المنطلق الرياضي الذي تأسس عليه معجم "العين" وأخضعه للبرمجة الحاسوبية للوقوف على هندسة النظام الصرفي والتركيبية للغة العربية عبر الوسيط الآلي حتى توصل إلى هذا الفكر الرياضي القائم على الدقة والتدقيق العميق في رؤية الخليل للمعجم محاولاً الاستفادة منه، وفي دراسة رضا (2020) تناول الباحث التوليد الآلي للجمل العربية بواسطة لغة الذكاء الاصطناعي، وقد خلص إلى أن البحث في الذكاء الاصطناعي فرض التواصل بين مجالين قد يبدو أنهما متنافرين هما المجال اللساني والمجال الحاسوبي من خلال العمل سويًا على إعداد برامج لمعالجة اللغة، وخلص قويدر (2020) في دراسته عن المعاجم العربية الإلكترونية وتطبيقات الذكاء الاصطناعي إلى بعض القصور المسجل على الجهود التطبيقية من حيث طبيعة المدونة المعجمية فيها، ومنها انضمام المعجم العربي عن واقعه، والاكتفاء بتسجيل المعاني والخلط في ترتيبها، كما تناولت أكثر من دراسة تطوير أدوات ANLP الحديثة باستخدام تقنيات التعلم الآلي (ML)، واستخدام خوارزميات ML على نطاق واسع في معالجة اللغات الطبيعية نظرًا لمعدل دقتها العالي بغض النظر عن متانة البيانات المستخدمة وبسبب سهولة تنفيذها، وهدفت دراسة بعنوان: كشف الخطأ للنص العربي باستخدام تصنيف التسلسل العصبي، إلى استخدام نماذج الشبكات العصبية لمهمة اكتشاف الأخطاء لنصوص اللغة العربية الفصحى الحديثة (MSA). بعد أن كانت غالبية الدراسات في هذا السياق تهتم باللغة الإنجليزية؛ لكن نتائج مثل هذه الدراسات تشهد نقصًا كبيرًا بسبب نقص الموارد، حيث لا يمكن تشغيل كل تكوين عدة مرات لبذور مختلفة، وتحتاج نتائج مثل هذه التجارب إلى الدعم والتكرار للوصول إلى نتائج دقيقة، ومثلاً على صعيد توظيف الذكاء الاصطناعي على القرآن الكريم الذي هو أساس عند العرب جميعاً، قامت دراسات على إنشاء بعض قواعد البيانات لتخزين المعلومات حول الكلمات والسور القرآنية، ثم أصبحت هناك حاجة أكبر للوصول إلى قواعد بيانات القرآن، ولما كان معظم الناس ليسوا من ذوي الخبرة في لغة SQL؛ لكنهم بحاجة إلى بناء أوامر SQL لاسترجاعها، عمل البعض على نظام مقترح لترجمة طلباتهم العربية الطبيعية مثل الأسئلة أو الجمل الحتمية إلى أوامر SQL لاسترداد الإجابات من قاعدة بيانات القرآن، كما يجري بعض العمليات التحليلية والصرفية؛ لكن يسعى القائمون في المستقبل، على توسيع قاعدة البيانات لتشمل المزيد من الجداول والسماط، وتوسيع النظام لقبول طلبات البحث الأكثر تعقيداً وربط الإجابة مع شرح معنى السورة وآية القرآن الكريم، دراسات أخرى استثمرت الذكاء الاصطناعي في البحث في الترجمة من العربية وإليها، للكشف عن المشاكل والأخطاء التي تواجه بعض العمليات.

والدراسة الحالية اهتمت بكل تلك الدراسات والبحوث الحديثة التي عنيت بالبحث في توظيف الذكاء الاصطناعي لخدمة اللغة العربية، لاسيما تلك التي عملت على ابتكار تطبيقات لمعالجة اللغة نحوياً وصرفياً أو على المستويات كافة، خصوصاً في هذا العصر الذي أصبحت فيه معالجة اللغة العربية بالحاسوب أمر أساسي وفي غاية الأهمية، يعتمد مستقبل اللغة ومستقبل العرب، وفي

عصر تشهد فيه معالجة اللغات الطبيعية مجالاً واسعاً متعدد التخصصات يربط بين علم الكمبيوتر واللسانيات والرياضيات وعلم النفس، ولما كانت هناك مهام كثيرة يجب أن يقوم بها الباحثون العرب في حقل اللغة العربية نحواً وصرفاً ودلالة وبلاغة ونطقاً لتيسير معالجة اللغة وتبسيطها وجعلها بين يدي العرب جميعاً من خلال تطبيقات مميزة تثري هذه الجوانب التي يعاني الباحثون والدارسون من صعوبات في دراستها والوصول إليها، لاسيما في قراءتهم للقرآن الكريم وفهم ما فيه من معاني ودلالات.

مما سبق كله فإن مشكلة الدراسة الحالية تتحدد بعد قراءات موسعة وملاحظات من الباحث حول الدراسات التي عُنت بتطبيقات الذكاء الاصطناعي في اللغة العربية ومعالجتها نحوياً وصرفياً، ومدى إفادتها لها، وبالتالي البحث في الجهود المنصبة في هذا الاتجاه، وما يواجهه هذا الأمر من صعوبات وتحديات، والرهنات والآفاق المستقبلية التي تحيط بالموضوع، كما تحاول الدراسة الوصول إلى تطبيقات تفيد الباحثين في معالجة اللغة العربية نحوياً وصرفياً، وذلك من خلال الوقوف على أبرز المشاكل والصعوبات التي يواجهها الطلبة والدارسون والباحثون، كما تحاول الدراسة الوقوف على القصور الذي تعاني منه بعض المحاولات والجهود التطبيقية التي تهتم بحوسبة اللغة وصناعة المعاجم العربية وترتيبها، في محاولة للدفع بهذا الجانب نحو التطوير والتحسين ليخدم العربية في جانب المعاجم وحوسبتها الذي هو أساس التطبيقات التي تعالج اللغة العربية نحوياً وصرفياً وأساسها.

أهمية الدراسة:

تتحدد أهمية الدراسة في:

1. عنايتها باللغة العربية. لغة القرآن الكريم.
2. وقوفها على موضوع مهم يفيد اللغة العربية.
3. محاولتها الإفادة من التقانات الحديثة والذكاء الاصطناعي في معالجة اللغة العربية.
4. التعرف على تطبيقات الذكاء الاصطناعي في اللغة العربية لمعالجة اللغة نحوياً وصرفياً.
5. بيانها وكشفها عن أهمية الذكاء الاصطناعي في معالجة اللغة نحوياً وصرفياً.
6. وقوفها على أبعاد توظيف الذكاء الاصطناعي في معالجة اللغة العربية، والصعوبات والتحديات التي تواجهه، والرؤى المستقبلية لهذه القضية، وأهميتها.

أهداف الدراسة:

تتمثل أهداف الدراسة في الإجابة عن التساؤلات التالية:

1. ما هو الذكاء الاصطناعي؟ وما أهمية توظيفه؟
2. كيف تستفيد اللغة العربية من الذكاء الاصطناعي؟
3. ما تطبيقات الذكاء الاصطناعي في اللغة العربية؟
4. ما الأمثلة على تطبيقات الذكاء الاصطناعي التي تهتم بمعالجة اللغة نحوياً وصرفياً؟ وكيف يمكن الاستفادة من الذكاء الاصطناعي وتوظيفه لمعالجة اللغة نحوياً وصرفياً؟

حدود الدراسة:

- تتمثل حدود الدراسة في الوقوف على تطبيقات الذكاء الاصطناعي في اللغة العربية _ معالجة اللغة نحوياً و صرفياً. من خلال التطبيقات التي انشغلت بهذا الأمر وتحليلها والكشف عن أهميتها وأبعادها، ودورها في خدمة اللغة العربية وغير ذلك من الأمور التي تتعلق بهذا الموضوع.

مصطلحات الدراسة:

- الذكاء الاصطناعي: يعرف الذكاء الاصطناعي بأنه علم يهدف إلى فهم طبيعة الذكاء الإنساني عن طريق عمل برامج للحاسب الآلي قادرة على محاكاة السلوك الإنساني المتسم بالذكاء. (بونيه، 1993: 11).
 - كما يعرف بأنه "ذلك الفرع من علوم الحاسوب (COMPUTER SCIENCE) الذي يمكن بواسطته خلق وتصميم برامج الحاسبات التي تحاكي أسلوب الذكاء الإنساني لكي يتمكن الحاسب من أداء بعض المهام بدلا من الانسان والتي تتطلب التفكير والتفهم والسمع والتكلم والحركة بأسلوب منطقي ومنظم. وترجع بدايته الى التحول من نظم البرمجة التقليدية بعد الحرب العالمية الثانية إلى استحداث برامج للحاسبات تتسم بمحاكاة الذكاء الإنساني في إجراء الألعاب ووضع الحلول لبعض الألغاز والتي أدت بدورها إلى نظم أكبر للمحاكاة، والتي تبلورت بعد ذلك أصبحت نظماً للذكاء الاصطناعي". (كاظم، 2012: 13)
 - ويعرف أيضًا بأنه: علم يهدف إلى جعل الحاسوب وغيره من الآلات تكتسب صفة الذكاء وتكون لها القدرة على القيام بأعمال ما زالت إلى عهد قريب حكرا على الإنسان كالتفكير والتعلم والإبداع والتخاطب، وهو مجموعة من السلوكيات والخصائص المعينة التي تتسم بها البرامج الحاسوبية تجعلها تحاكي القدرات الذهنية البشرية وأنماط عملها، من أهم هذه الخاصيات القدرة على التعلم الذاتي والاستنتاج ورد الفعل على أوضاع لم تبرمج في الآلة ولم تبرمج الآلة عليها. (سلطاني، 2020: 509)
 - كما يعرف كذلك بأنه: العلم الذي يشتغل بابتكار وتطوير خوارزمات مفيدة تُسهّم في المحاكاة الآلية لقدرات الدماغ البشري؛ من إدراك للبيئة المحيطة، والاستجابة المناسبة لمثيراتها، وتعلم، وتخطيط، وإيجاد حلول للمسائل المستجدة، والتواصل اللغوي، وإدارة للتراكم المعرفي، ... إلخ. (عطية وآخرون، 2019: 29)
- والذكاء الاصطناعي يقابل مصطلحاً آخر هو صلب الدراسات الحديثة التي تعنى بتوظيف التقانات والاختراعات الحديثة في خدمة اللغة العربية وإتاحتها للغير، وهو علم اللسانيات الحاسوبية، وقد تم وصف هذا العلم الذي يتفرع من علوم اللسانيات بـ"الحاسوبية) التي تشير إلى نسبه وتعلقه بالحاسوب وهي الآلة التي تتجلى فيها معالجة المعلومات بطريقة آلية" (أحمد، (د.ت): (3)
- وإن الجانب التطبيقي من اللسانيات الحاسوبية يهتم "بالنتاج العملي لنمذجة الاستعمال الإنساني للغة، وهو يهدف إلى إنتاج برامج ذات معرفة باللغة الإنسانية، وهذه البرامج مما تشند الحاجة إليه لتحسين التفاعل بين الإنسان والآلة؛ إذ إن العقبة الأساسية في طريق هذا التفاعل بين الإنسان والحاسوب إنما هي عقبة التواصل". (الموسى، 2000: 13)
- اللغة العربية: أو لغة الضاد، فهي لغة القرآن الكريم المنزل على المسلمين بنزول الوحي على سيدنا محمد (صلى الله عليه وسلم) ونشر الدعوة الإسلامية، وهي اللغة الرابعة في العالم، والتي تتميز بالعديد من الخصائص والسمات عن سائر اللغات الأخرى، وهي لغة حية، وغنية، مواكبة لكل العصور، وقد كرمها الله على سائر اللغات، وحفظها بحفظه لكتابه العزيز.

- أما المعالجة اللغوية للغة فهي: "عملية خلق أنظمة وبرامج معلوماتية و"محطات عمل" تحلل النصوص المكتوبة والمنطوقة آلياً أي دون تدخل الانسان وذلك من أجل مساعدة مستعمل الحاسوب على حل بعض الأمور والمسائل المتعلقة باللغة، مثل: برامج الترجمة الآلية، التصحيح الإملائي والقواعدي، الخلاصة الآلية، تحليل الخطاب آلياً، الإحصاء الآلي للمفردات، برامج إنتاج المصطلحات... إلخ". (سلطاني، 2020: 252)

الدراسات السابقة:

تتمثل أبرز الدراسات السابقة التي اهتمت بموضوع الدراسة الحالية خلال العقد الأخير، واستفاد منها الباحث كثيراً خلال بحثه ودراسته هي الدراسات التالية، وقد تم تقسيمها في محورين:

- **المحور الأول: دراسات نظرية في مجال توظيف الذكاء الاصطناعي والتقنيات الحديثة في خدمة اللغة العربية:**
1- دراسة بعنوان: الذكاء الاصطناعي: مداخله ومفاهيمه وأهم خصائصه وتطبيقاته، المعالجة الآلية للغة العربية. أعمال المنتدى الوطني. اللغة العربية وبرامج الذكاء الاصطناعي الواقع والرهانات. المجلس الأعلى للغة العربية.

يبحث البحث في كيفية تطبيق المشتغلين بالذكاء الاصطناعي لأساليبه وقوانينه في أي جانب من جوانب حياة الإنسان العملية والفكرية، فيقف بالدراسة عند الذكاء الاصطناعي مفهومه وخصائصه، وقدراته، قبل أن يتحدث عن مجالاته الأساسية، وأنواعه، ثم يقف عند المعالجة الآلية للغة العربية، والمعالجة الآلية للكلمة العربية، واشتقاق الكلمة وتوليدها، ويطبق على ذلك بالمعجم الحاسوبي، وتحليل الكلمة العربية والتحليل الآلي للنص.

2- دراسة بعنوان: المعاجم العربية الإلكترونية وتطبيقات الذكاء الاصطناعي، مقارنة تاريخية مفاهيمية وظيفية. أعمال المنتدى الوطني. اللغة العربية وبرامج الذكاء الاصطناعي الواقع والرهانات. المجلس الأعلى للغة العربية. (353-370)

وهذا البحث عبارة عن قراءة في البنية والوظائف والتطبيقات " في سياق الاهتمام بالمعجم الإلكتروني في عصر الثورة الرقمية ورهاناتها لتناقش آفاق الحوسبة المعجمية العربية، من حيث إرصاصاتها وآفاقها، بالوقوف عند مفهوم المعجم الإلكتروني ومراحله وبنيتها ووظائفه، ثم يعرج على التطبيقات الحاسوبية في المعجم اللغوي العربي، مثل الموقع الإلكتروني العربي، وموقع معاجم اللغة، وقد خلص إلى بعض الفصول المسجل على هذه الجهود التطبيقية من حيث طبيعة المدونة المعجمية فيها، منها انقسام المعجم العربي عن واقعها، والاكتفاء بتسجيل المعاني والخلط في ترتيبها.

3- دراسة بعنوان: مشاكل الترجمة الآلية من اللغة العربية: تقييم ثلاثة أنظمة. (Problems of Arabic Machine) (Translation: evaluation of three systems)

يصف البحث ترجمات ثلاثة أنظمة على شبكة المعلومات (الإنترنت) Google : و Sakhr و Systran ، باستخدام مجموعتين من النصوص العربية والإنجليزية كمدخلات. يقوم بتشخيص الأعطال ومحاولات الكشف عن الأسباب، في محاولة لإلقاء الضوء على المناطق التي لا يوجد فيها حلول للترجمة الصحيحة. كما يتم تصنيف وتحليل العيوب ومشاكل الترجمة وتواجه طريقتا الترجمة (من العربية وإليها) نطاقاً واسعاً من المشكلات اللغوية الشائعة بالإضافة إلى المشكلات الخاصة بالأسلوب. لذلك تمت مناقشة هذه المشاكل وإعطاء أمثلة على المخرجات. يثير البحث أسئلة يجب أن تساعد إجاباتها في تحسين أنظمة الترجمة الآلية. وتتناول الأسئلة إنشاء المعادلات، والبيئة المعجمية، والتجميع. وفي هذا البحث يتم توضيح ومناقشة جميع الحالات منذ تطويرها، خضعت الترجمة الآلية العربية للوصف والتقييم ويشير إلى أن الترجمة الآلية بمساعدة الإنسان (HAMT) هي أفضل طريقة. وينتقد الترجمة الآلية (MT) باعتبارها غير فعالة، ويقدم ثلاث عينات من ترجمات الترجمة الآلية (دون الإشارة إلى النظام الذي أنتجها). ولم يُقصد من MT أبداً التعامل مع الشّعور، ولا ينبغي أن يكون كذلك. لا يمكن الادعاء بأن الكتابة الإبداعية هي المجال الذي

يمكن استخدام الترجمة الآلية فيه، ولا يمكن اعتبارها معيارًا لتقييم أدائها. نظرًا لأن العربية والإنجليزية لغتان بعيدتان عن عائلتين غير مرتبطتين، فلا بد أن تواجه الترجمة الآلية العديد من المشكلات في إنتاج ترجمات متماسكة وذات مغزى بين هذه اللغات. وعند تقييم ناتج الترجمة الآلية، فإن المعنى المنقول هو أهم نقطة تركيز. وتعتبر الدلالات جانبًا مهمًا جدًا في الترجمة كنظرية وتطبيق وبالتالي فهي تتطلب أقصى اهتمامنا.

4-دراسة بعنوان: أنظمة معالجة اللغة العربية الطبيعية وأنظمة التعلم الآلي: (Arabic Natural Language Processing and Machine Learning-Based Systems)

تتكون معالجة اللغة العربية الطبيعية (ANLP) من BSTRACT من تطوير تقنيات وأدوات يمكنها استخدام وتحليل اللغة العربية في السياقات المكتوبة والمنطوقة. وتقدم ANLP مساهمة مهمة للعديد من الأنظمة المطورة الحالية. كما يوفر للمتحدثين باللغة العربية وغير العربية أدوات مفيدة ومريحة يمكن استخدامها في مجالات مختلفة. وقد تمّ تطوير أدوات ANLP الحديثة باستخدام تقنيات التعلم الآلي (ML). وتستخدم خوارزميات ML على نطاق واسع في معالجة اللغات الطبيعية نظرًا لمعدل دقتها العالي بغض النظر عن متانة البيانات المستخدمة وبسبب سهولة تنفيذها. ومن ناحية أخرى، تتضمن منهجية تطبيقات ANLP القائمة على ML عدة مراحل متميزة. لذلك، من الضروري التعرف على هذه المراحل وفهما بالتفصيل بالإضافة إلى خوارزميات تعلم الآلة الأكثر استخدامًا. والاستطلاع يناقش هذا المفهوم بالتفصيل، ويظهر مشاركة تقنيات ML في تطوير مثل هذه الأدوات، ويحدد التقنيات المعروفة المستخدمة في ANLP. علاوة على ذلك، يناقش هذا الاستطلاع خصائص وتعقيد اللغة العربية بالإضافة إلى أهمية واحتياجات ANLP معالجة اللغة الطبيعية (NLP) هي أحد مجالات علوم الكمبيوتر التي تسعى إلى إنشاء مفاهيم وإيجاد طرق وبناء برمجيات قادرة على فهم ودراسة وإنتاج لغات بشرية طبيعية لتمكين التفاعل البشري مع أجهزة الكمبيوتر من خلال الكتابة والكلام. وبعبارة أخرى، تساعد البرمجة اللغوية العصبية أجهزة الكمبيوتر على تحديد الطرق التي بها استخدام اللغة.

وقد جذبت معالجة اللغة العربية الطبيعية (ANLP) العديد من الباحثين بعد إجراء أبحاث مهمة حول البرمجة اللغوية العصبية الإنجليزية واللغات الأخرى. وتم إنشاء العديد من مختبرات ANLP في الآونة الأخيرة، ولذلك تلقى ANLP مزيدًا من الاهتمام، وتم أيضًا تطوير العديد من التطبيقات بما في ذلك تصنيف النص واكتشاف البريد العشوائي في صفحات الويب، وتحليل المشاعر ومع ذلك، فإن تطوير أدوات ANLP يتطلب جهدًا إضافيًا بسبب صعوبتين رئيسيتين: الجمع بين الحروف في اللغة العربية وإزالة علامات التشكيل التي تمثل حروف العلة. والهدف من هذه التقنيات هو تمكين أجهزة الكمبيوتر من التعلم دون برمجة واضحة. تم تطبيق ML بنجاح في العديد من مهام الحوسبة الصعبة والمعقدة مثل ANLP دون تصميم وبرمجة خوارزميات واضحة. بالإضافة إلى ذلك، أدى نطاق خوارزميات ML التي تعطي نتائج مرضية إلى أن تشارك ML بشكل كبير في ANLP و NLP بشكل عام. تصف الدراسات الاستقصائية المختلفة في الأدبيات وتناقش صعوبة وتعقيد معالجة اللغة العربية (على سبيل المثال). يقدم هذا البحث مراجعة شاملة لأنظمة ML المستندة إلى ANLP. يركز هذا الاستطلاع على: عرض خصائص وتحديات وتعقيد اللغة العربية لتزويد الباحثين الجدد في هذا المجال بمعرفة خلفية موجزة عن ANLP، تحديد المجالات السائدة التي تستخدم تطبيقات ANLP، كما يقدم هذا المقال لمحة موجزة عن اللغة العربية وخصائصها. تعد المجموعات عالية الجودة تمثيلية ومتوازنة بالنظر إلى النوع أو اللغة التي تمثلها. ومع ذلك، فإن أحد التحديات الرئيسية في معظم تطبيقات ANLP هو وجود نصوص ذهبية قياسية حيث يتم وضع علامات على النص بشكل صحيح وفقًا لأحدث الإرشادات. ويعد هذا التحدي أمرًا بالغ الأهمية للتعلم الآلي الذي يعتمد على البيانات للحصول على عملية تصنيف أكثر دقة. ولكن هناك نقص في الأدوات المتخصصة للمساعدة في عملية جمع البيانات وتحديدًا باللغة العربية، بالنظر إلى جميع أنواعها. تشمل البيانات المجموعة والمعجم وغيرها.

أحد أهم الجوانب التي تؤثر على أداء تصنيف النص هو وجود عدد مناسب من الفئات. علاوة على ذلك، هناك حاجة إلى وجود ميزات تمثيلية وأكثر دقة من النص تشير إلى فئة تمثيل النص وتلتقط أكبر عدد ممكن من الخصائص العربية. ومع ذلك، يمكن للباحثين الاستفادة من الميزات المستقلة عن اللغة، وهي السمات التي ترتبط عبر اللغات على الرغم من وجود اختلاف بين كل لغة. في تطبيقات تحليل المشاعر، من الصعب تحديد اتجاه مصطلحات المشاعر العربية في التغريدات. قد تكون هذه الصعوبة بسبب تعقيد اللغة العربية نفسها واستخدام تويتر كقناة اتصال غير رسمية. لا يزال قياس القدرة على القراءة للنص العربي في مرحلة التحسين. ومن الصعب تحديد السمات التي تؤثر على قابلية قراءة نص معين. كما يؤثر اختيار الميزات التمثيلية على أداء التصنيف. هناك حاجة إلى أدوات وجمع بيانات مصممة خصيصاً للغة العربية. يمكن دمج هذه الأدوات مع المواصفات القياسية والرسمية لإضافة تعليق توضيحي على نص ممثل للتطبيق ولإنشاء مجموعة قياسية ذهبية. يمكن استشارة هذه المواصفات مع خبراء في هذا المجال. محاولة أولية لإنشاء مثل هذه الأداة هي "مدد"، وهي أداة توضيحية للأغراض العامة للنص العربي مع التركيز على شرح سهولة القراءة. وينطبق الشيء نفسه أيضاً على أدوات المعالجة المسبقة لـ ANLP. وتشكل خصائص اللغة العربية تحدياً جوهرياً لمطوري وباحثين معالجة اللغة العربية. أبرز الخصائص هي الانعكاس العالي وغياب قواعد الرسملة وعلامات الترقيم. تم إنشاء عدد قليل من الأدوات الأساسية من قبل باحثي ANLP لمعالجة النص العربي مثل مقسمات الرسائل، والمميزات، والمشتقات الخفيفة. تُستخدم هذه الأدوات لإعداد البيانات لمراحل المعالجة عالية المستوى.

5- معالجة اللغة العربية الطبيعية: التحديات والحلول (Arabic Natural Language Processing: Challenges and Solutions)

تقدم اللغة العربية للباحثين ومطوري تطبيقات معالجة اللغة الطبيعية (NLP) للنص والكلام العربي تحديات خطيرة والغرض من هذه المقالة هو وصف بعض هذه التحديات وتقديم بعض الحلول التي من شأنها توجيه الممارسين الحاليين والمستقبليين في مجال معالجة اللغة العربية الطبيعية (ANLP). يبدأ الباحث بالخصائص العامة للغة العربية في الأقسام ثم تنتقل إلى المزيد من الخصائص المحددة للغة في بقية المقال. في القسم الأول من هذه المقالة يلقي الضوء على أهمية اللغة العربية ووصف خصائصها العامة. ويعرض القسم الثاني ميزة ازدواجية اللغة العربية التي توضح كيف تختلف الجوانب اللغوية الاجتماعية للغة العربية عن اللغات الأخرى. وتتم مناقشة استقرار اللغة العربية Diglossia وأثارها على تطبيقات ANLP وطرق التعامل مع هذه الخاصية الإشكالية. ويتناول القسم الثالث خصائص الخط العربي وتفجر الغموض الناتج عن غياب تمثيلات الحروف المتحركة القصيرة وعلامات الحالة العلنية في النصوص العربية المعاصرة. ويقدم في القسم الرابع ميزات محددة للغة العربية مثل الخاصية nonconcentative للصرف العربي، واللغة العربية كلغة اشتقاقية، والعربية كلغة مؤيدة للإسقاط، والتحدي الذي تفرضه هذه الخصائص على ANLP. كما يقدم الحلول التي تم اعتمادها بالفعل من قبل بعض الباحثين الرواد في هذا المجال. في القسم الخامس نشير إلى عدم وجود قواعد نحوية رسمية ومحددة للغة العربية الفصحى الحديثة مما يعيق تقدم أنظمة ANLP الأكثر تقدماً. إذن هناك ميزات للغة العربية تشكل تحدياً بطبيعتها لباحثي ومطوري ANLP. وتشمل هذه الميزات الطبيعة غير المترابطة للصرف العربي، وغياب التمثيل الهجائي لحروف العلة العربية القصيرة من النصوص العربية المعاصرة، والحاجة إلى قواعد نحوية دقيقة للغة العربية الفصحى تحدد المكونات اللغوية في حالة عدم وجود علامات للحالة. يجب أن تصف القواعد الجديدة أيضاً جوانب مهمة مثل العلاقات الجذابة، والجمل غير الموضوعية، وتحليل الخطاب. على الرغم من هذه التحديات، فقد تم إنجاز عمل هام في ANLP في تطبيقات مثل استخراج الكيانات والترجمة الآلية.

6-دراسة بعنوان: الذكاء الاصطناعي ومعالجة اللغة الطبيعية: المؤسسات العربية في برامج الترجمة عبر الإنترنت Artificial intelligence and natural language processing: the Arabic corpora in online translation software

من المفارقات أن نلاحظ أن محتوى الإنترنت باللغة العربية على مستوى العالم لا يتجاوز 1.1٪، بينما يتحدث 5٪ من سكان العالم اللغة العربية. يشير هذا إلى التواجد غير المتناسب لمحتوى اللغة العربية على الإنترنت مقارنة باللغات الأخرى، وهو ما قد يرجع لأسباب عديدة منها نقص الخبراء في مجال اللغة العربية. ستبحث هذه الدراسة البحثية في تأثير برامج الترجمة الآلية (MT) وأدوات ذاكرة الترجمة التي يستخدمها المجتمع العربي على نطاق واسع لأغراضهم الأكاديمية والتجارية. تهدف الدراسة إلى معرفة ما إذا كان من الممكن إحداث نقلة نوعية من التعريب العربي إلى العولمة العربية. ومن ثم تسهيل استخدام تقنيات البرمجة اللغوية العصبية في مواجهة الإنسان مع الكمبيوتر. لهذه الدراسة؛ يجب دراسة عدد قليل من برامج الترجمة الآلية) مثل SYSTRAN و IBM Watson) لمحتواها وتطبيقاتها، لتحديد استخدامها دون تدخل بشري والاحتفاظ بمعنى النص الأصلي المعالجة (NLP) باعتبارها فرع الذكاء الاصطناعي (AI) الذي يتعامل مع تحليل اللغة التي يستخدمها الإنسان للتفاعل مع الكمبيوتر. التحدي الكبير الذي واجهه الإنسان في مثل هذه المواجهة هو تعليم الكمبيوتر اللغة التي يمكن للرجل أن يتعلمها ويفهمها ويتفاعل بها، وهي اللغة العربية في السياق الحالي. كونها أكبر لغة سامية حية، اللغة الرسمية لـ 23 دولة، يتحدث بها أكثر من 360 مليون شخص في جميع أنحاء العالم. هذا يتحدث عن الوجود غير المتناسب لمحتوى اللغة العربية على الإنترنت مقارنة باللغات الأخرى. السبب الذي قدمه خبراء البرمجة اللغوية العصبية فيما يتعلق بتحليل استخدام اللغة العربية Diglossia هو أن اللغة العربية لها شكلين

7-دراسة بعنوان التحديات الرئيسية للترجمة الآلية من اللغة العربية (The Key Challenges for Arabic Machine Translation)

إن ترجمة اللغة العربية إلى لغات أخرى فيه مشاكل لغوية متعددة، حيث لا يمكن أن تتطابق لغتان، سواء في المعنى المعطى للرموز المطابقة أو في طرق ترتيب هذه الرموز في عبارات وجمل. تنشأ مشاكل معجمية ونحوية ودلالية عند ترجمة معنى الكلمات العربية إلى اللغة الإنجليزية. تطرح الترجمة الآلية (MT) إلى اللغات الغنية شكلياً (MRL) العديد من التحديات، بدءاً من التعامل مع المفردات المعقدة والغنية، إلى تصميم مقاييس الترجمة الآلية المناسبة التي تأخذ علم التشكل في الاعتبار. ويقدم البحث التحديات الرئيسية التي تواجه ترجمة اللغة العربية إلى الإنجليزية. ووفقاً للغة العربية الفصحى واللغة العربية الفصحى الحديثة واللهجة العربية. وقد اقترح أيضاً خطأً من الحجة لصالح تصور توضيح معنى الكلمات والاستعارة والتعرف على الكيان المحدد. حتى الآن، تم نشر القليل من الأعمال حول ترجمة اللغة العربية. عادة ما تكون الجمل العربية طويلة، ولا تؤثر علامات الترقيم على تفسير النص. يعتبر التحليل السياقي مهماً جداً في ترجمة النص العربي، من أجل فهم المعنى الدقيق للكلمة. كما يشكل غياب التشكيل في معظم MSD وبشكل كامل في اللهجة العربية تحدياً حقيقياً في معالجة اللغة العربية الطبيعية، خاصة في الترجمة الآلية. لأن اللغة العربية لها العديد من الميزات التي تمثل تحدياً بطبيعته للباحثين في البرمجة اللغوية العصبية. الصعوبات المرتبطة بإدراك الحاجة إلى الأفعال الكاملة أمثال "هو"، وظروف المكان - أمثال "هناك"، والتعرف على الحواس المناسبة للكلمات غير المكتوبة، وممارسة الترجمة على مستوى الكلمات المركبة هي بعض القضايا الرئيسية. وتعتبر اللغة العربية الفصحى بلاغية بسبب مظاهرها الأسلوبية واللغوية. والمتحدثون الذين ليسوا على دراية جيدة بهذا الخطاب الديني لا يستطيعون أن ينجحوا في نقل الجوانب اللغوية والأسلوبية والثقافية في اللغة المترجمة. على عكس النص العادي.

من خلال عملية المسح التي قام بها الباحث على الدراسات السابقة تبين أن أهمية معالجة اللغة العربية بالحاسوب هو أمر أساسي في غاية الأهمية وعليه يعتمد مستقبل اللغة ومستقبل العرب، كما تعد معالجة اللغات الطبيعية مجالاً واسعاً متعدد التخصصات يربط بين علم الكمبيوتر واللسانيات والرياضيات وعلم النفس، وأن الدراسات الخاصة باللغة العربية والحوسبة مترابطة مع بعضها البعض وكل منها يعتمد على الآخر. وهناك مهام كثيرة يجب أن يقوم بها الباحثون العرب في حقل اللغة العربية نحواً وصرفاً ودلالة وبلاغة ونطقاً من قبل المتخصصين باللغة العربية، المشكّل الآلي المقترح الذي يساعد الكاتب على تشكيل النص الذي يدخل إليه بأقل عناء ممكن. والإملاء والصرف هما أبرز تحديات اللغة العربية في مجال معالجة اللغات الطبيعية. ومن المهم جداً توظيف الذكاء الاصطناعي في اللغة العربية وذلك للحاق بركب التطور العلمي واللغوي في العالم وإدخال لغتنا في شتى أنواع الأجهزة والتقنيات الحديثة المتاحة.

- المحور الثاني: دراسات تطبيقية في مجال توظيف الذكاء الاصطناعي والتقنيات الحديثة في خدمة اللغة العربية:

1- دراسة بعنوان: النظرة الخليلية الحديثة مفاهيم أساسية. مركز البحث العلمي والتقني لتطوير اللغة العربية. الجزائر. ع.4.
استثمر الدكتور صالح المنطلق الرياضي الذي تأسس عليه معجم "العين" وأخضعه للبرمجة الحاسوبية، وذلك بقصد الوقوف على هندسة النظام الصرفي والتركيبية للغة العربية عبر الوسيط الآلي، وقد أبرز صالح الفكر الرياضي القائم على الدقة والتدقيق العميق في رؤية الخليل للمعجم، وكيفية وضعه له بناءً على دراسة متقدمة، هي المحور الأساسي الذي يتحدث ويبحث عنه الذكاء الاصطناعي وتوظيفه في خدمة العلوم عمومًا، واللغة العربية بشكل خاص.

2- دراسة بعنوان: التوليد الآلي للجمل العربية بواسطة لغة الذكاء الاصطناعي. أعمال الملتقى الوطني. اللغة العربية وبرامج الذكاء الاصطناعي الواقع والرهانات. المجلس الأعلى للغة العربية. (409-417)

بناءً على اجتهاد الباحثين في صياغة لغات برمجية لها قدرة عالية على معالجة اللغة وتحليلها لتطوير التطبيقات المرتبطة بها وإعطائها فعالية أكبر، ومنها لغة برولوج التي وجدت اهتماماً بالغا في معالجة اللغة نظراً لما تتمتع به من ميزات تقنية ولتأسسها على البرمجة المنطقية؛ نظر البحث في المعالجة الآلية للغة والتمثيل التركيبي للجملة وكيفيته، وقد خلص إلى أن البحث في الذكاء الاصطناعي فرض التواصل بين مجالين قد يبدوان في الظاهر متنافرين هما المجال اللساني والمجال الحاسوبي من خلال العمل سوياً على إعداد برامج لمعالجة اللغة، وذلك عبر لغة الذكاء الاصطناعي برولوج التي تتمتع بكثير من المزايا لتمثيل الجملة تركيبياً وتحليلها قصد معرفة مدى سلامة بنائها النحوي.

3- دراسة بعنوان: كشف الخطأ للنص العربي باستخدام تصنيف التسلسل العصبي Error Detection for Arabic Text Using Neural Sequence Labelling

حظيت اللغة الإنجليزية، حتى الآن، بأكبر قدر من الاهتمام في البحث المتعلق بالتصحيح التلقائي للأخطاء النحوية واكتشافها. ومع ذلك، فقد تم التحقيق في هذه المهام بشكل أقل بالنسبة للغات الأخرى. يقدم هذا البحث التجارب الأولى باستخدام نماذج الشبكات العصبية لمهمة اكتشاف الأخطاء لنصوص اللغة العربية الفصحى الحديثة (MSA). نحن نحقق في العديد من هياكل الشبكات العصبية ونبلغ عن نتائج التقييم التي تم الحصول عليها من خلال تطبيق التحقق المتبادل على البيانات. تتضمن جميع التجارب مجموعة أساسية. تتكون المجموعة من 494 جملة و 620 جملة بعد الزيادة. حققت نماذجنا دقة قصوى بلغت 78.09٪، واسترجاع 83.95٪، ودرجة F0.5 تبلغ 79.62٪. في مهمة اكتشاف الأخطاء باستخدام SimpleRNN باستخدام LSTM، حققنا دقة قصوى بلغت 79.21٪، واسترجاع 93.8٪، ودرجة F0.5 بلغت 79.16٪. أخيراً، تم تحقيق أفضل النتائج باستخدام BiLSTM بدقة قصوى تبلغ 80.74٪، واسترجاع 85.73٪، ودرجة

F0.5 تبلغ 81.55%. قمنا بمقارنة نتائج النماذج الثلاثة بخط الأساس، وهو مدقق نحوي متوفر تجارياً (Microsoft Word (2007) تفوقت كل من LSTM و BiLSTM و SimpleRNN على خط الأساس في الدقة و F0.5 يظهر عملنا النتائج الأولية، مما يدل على أن معماريات الشبكة العصبية لاكتشاف الأخطاء من خلال تصنيف التسلسل يمكن تطبيقها بنجاح على النص العربي. كما ركز هذا البحث على اكتشاف الأخطاء في نص MSA باستخدام وسم التسلسل العصبي. وقدم خلفية وعمل متعلق باللغة العربية ومناهج للكشف الآلي للأخطاء النحوية وتصحيحها للغة العربية واللغات الأخرى. وصف أيضاً الجسم الذي أنشئ لهذه المهمة كان أحد القيود الرئيسية لهذا المشروع هو نقص البيانات، والذي دعا بدوره إلى استخدام التحقق المتبادل. على الرغم من الرضا عن النتائج، فقد تم تبسيط النماذج حتى تتمكن من استيعاب مجموعة البيانات الصغيرة. ومع ذلك، نعتقد أن البيانات الأكبر والشبكات الأكبر ستكون قادرة على التعميم بشكل أكبر عند تقديمها ببيانات جديدة. بالإضافة إلى ذلك، كانت الجمل الجماعية قصيرة (بحد أقصى 17 كلمة)؛ ومع ذلك، نعتقد أن النموذج كان سيستفيد من جمل أطول من أجل التعلم من سلاسل الكلمات الأطول. علاوة على ذلك، فإن حقيقة أن الشبكات العصبية عشوائية تتطلب تقديم بذور ثابتة في مولدات أرقام عشوائية. لقد ثبت أن النتائج قد تتغير عند استخدام أعداد بذور مختلفة. لذلك، يجب تقييم كل مجموعة من تكوينات المعلمات الفائقة عددًا من المرات لكل رقم أولي، بحيث يتم حساب متوسط النتائج ومقارنتها. يمكن استخدام عدد من 5 إلى 30 بذرة بشكل عشوائي. ستنجح هذه العملية استخلاص النتائج وإجراء مقارنات عادلة بين النماذج المختلفة في حالتنا، قمنا بتثبيت قيمة أولية واحدة لجميع التجارب (إلى 42)، لأنه بسبب نقص الموارد، لم تتمكن من تشغيل كل تكوين عدة مرات لبذور مختلفة. ومع ذلك، فإن هذا لا يعيق حقيقة أن تجاربنا قابلة للتكرار. ويمكن توسيع النتائج الموضحة في هذه الورقة وتحسينها بعدة طرق. نقترح استخدام مجموعة تدريب أكبر بجمل أطول، وإجراء المزيد من التجارب باستخدام المزيد من المعلمات الفائقة، واستخدام شبكات أعمق ذات حجم دمج أكبر، وتشغيل التكوينات عدة مرات باستخدام مجموعة متنوعة من القيم الأولية والإبلاغ عن متوسط النتائج. بالإضافة إلى ذلك، يمكن أن يكون تقييم أداء مختلف معماريات الشبكة العصبية المقترحة لكل نوع خطأ مفيداً وقد يسهل وسيلة لمقارنة الأنظمة. علاوة على ذلك، يمكن أن يؤدي دمج علامات POS في الشبكة العصبية إلى تحسين اكتشاف الأخطاء.

4-دراسة بعنوان: تقييم نظام الترجمة الآلية العربية على أساس لغة الشبكات العالمية **Evaluation of Arabic Machine Translation System based on the Universal Networking Language**

يتحدث هذا البحث عن نظام الترجمة الآلية (MT) على أساس نصح interlingua ، نظام لغة الشبكة العالمية (UNL)، المصمم للترجمة متعددة اللغات. وتتناول الدراسة تقييم الترجمة من الإنجليزية إلى العربية وتهدف إلى مقارنة أنظمة الترجمة الآلية القائمة على UNL مع الأنظمة الأخرى. كما أنه يعمل على تحليل تطور النظام البديل من خلال مقارنة المخرجات على مستوى الجملة. يتم إجراء التقييم على موسوعة أنظمة دعم الحياة (EOLSS)، وهي مجموعة واسعة النطاق تغطي خلفيات لغوية وثقافية متعددة. يتم تقييم ثلاثة مقاييس آلية، وهي BLEU و F1 و Fmean بعد تكييفها مع اللغة العربية. وقد كشفت النتائج أن UNL MT يتفوق على الأنظمة الأخرى لجميع المقاييس. ويقدم هذا البحث، تقييماً لنظام الترجمة الآلية على أساس نظام UNL. وتم إجراء التقييم على موسوعة أنظمة دعم الحياة (EOLSS). تم تقييم ثلاثة مقاييس آلية مستخدمة على نطاق واسع، وهي BLEU و F1 و Fmean. وتم تعديل المقاييس الثلاثة لتتكيف مع بعض الخصائص المميزة في اللغة العربية. وتمت مقارنة نظام MT UNL بالأنظمة الأخرى التي تدعم الترجمة من الإنجليزية إلى العربية، مثل Google Tarjim و Babylon. كشفت النتائج أن أداء UNL كان أفضل من الأنظمة الثلاثة في جميع المقاييس، خاصة عند إنشاء جمل ذات بنية معقدة. وأظهر تقييم الإصدارات المشروحة لمخرجات UNL أنه يمكن استخدامها كمراجع رخيصة لإبراز اتجاه سلوك الأنظمة. كشفت النتائج أيضاً أن المقاييس الحالية لا تلتقط ميزات مثل التماسك والنمط العربي النموذجي. وبالتالي؛ يجب القيام بالمزيد من

العمل في هذا الاتجاه. وسيعمل إطار التقييم المقدم على تحليل المزيد من التطوير في UNL من خلال مقارنة مخرجاته بالتغييرات المقترحة.

5-دراسة بعنوان: نظام واجهة اللغة العربية الطبيعية لقاعدة بيانات القرآن الكريم: **An Arabic Natural Language Interface System for a Database of the Holy Quran**

في الوقت الحالي، نمت الحاجة إلى البحث في الكلمات والأشياء والموضوعات وإحصائيات الكلمات وأجزاء من القرآن الكريم بشكل سريع بالتزامن مع تزايد عدد المسلمين والاستخدام الهائل للهواتف الذكية والأجهزة اللوحية. ونظرًا لاستخدام قواعد البيانات في جميع أنشطة حياتنا تقريبًا، فقد تم إنشاء بعض قواعد البيانات لتخزين المعلومات حول الكلمات والصور القرآنية. وأصبحت الحاجة إلى الوصول إلى قواعد بيانات القرآن مهمة للغاية والتي يمكن القيام بها من خلال تطبيقات قواعد البيانات أو باستخدام أوامر SQL، مباشرة من موقع قاعدة البيانات أو بشكل غير مباشر بتنسيق خاص من خلال LAN أو حتى من خلال WEB. معظم الناس ليسوا من ذوي الخبرة في لغة SQL، لكنهم بحاجة إلى بناء أوامر SQL لاسترجاعها. سيقوم النظام المقترح بترجمة طلباتهم العربية الطبيعية مثل الأسئلة أو الجمل الحتمية إلى أوامر SQL لاسترداد الإجابات من قاعدة بيانات القرآن. سيتم إجراء بعض العمليات التحليلية والصرفية وفقًا لمجموعة فرعية من القواعد النحوية العربية الحالية من السياق للعمل كطبقة واجهة بين المستخدمين وقاعدة البيانات، ثامنًا. الاستنتاجات والعمل المستقبلي. يلي النظام المقدم الحاجة إلى الوصول إلى قواعد بيانات القرآن من خلال LAN أو WEB لجميع المستخدمين، خاصة بدون معرفة بقاعدة البيانات. ويمكن أن تقبل الطلبات العربية الطبيعية مثل البيانات أو الأسئلة الحتمية. ثم قام بإنشاء أمر SQL المناسب ليتم التحقق منه وتنفيذه. أخيرًا يقدم الإجابة من قاعدة بيانات القرآن للمستخدم بطريقة سهلة. تم إجراء تحليل وعمليات صرفية صغيرة وفقًا لمجموعة فرعية من القواعد النحوية العربية الحالية من السياق للعمل كطبقة واجهة بين المستخدمين وقاعدة البيانات.

في المستقبل، سيتم توسيع قاعدة البيانات لتشمل المزيد من الجداول والسماح. كما سيتم توسيع النظام لقبول طلبات البحث الأكثر تعقيدًا وربط الإجابة مع شرح معنى السورة وآية القرآن الكريم.

6-دراسة بعنوان: النهج القائم على القواعد في معالجة اللغة العربية الطبيعية (**Rule-based Approach in Arabic**) **(Natural Language Processing)**

تم استخدام النهج القائم على القواعد بنجاح في تطوير العديد من أنظمة معالجة اللغة الطبيعية. وتعتمد الأنظمة التي تستخدم التحولات المستندة إلى القواعد على جوهر المعرفة اللغوية الصلبة. ويمكن إعادة استخدام المعرفة اللغوية المكتسبة لنظام معالجة لغة طبيعية لبناء المعرفة المطلوبة لمهمة مماثلة في نظام آخر. كما تتضح ميزة النهج القائم على القواعد مقارنة بالنهج القائم على المجموعة في أن: اللغات ذات الموارد الأقل، والتي لا تتوفر لها مجموعات كبيرة، من المحتمل أن تكون متوازنة أو ثنائية اللغة، مع الهياكل والكيانات التمثيلية، ولا يمكن تحملها بسهولة، ولغات الثرية شكليًا، والتي حتى مع توفر الجسيمات تعاني من ندرة البيانات. وقد حفزت هذه العديد من الباحثين على اتباع النهج القائم على القواعد بشكل كامل أو جزئي في تطوير أدوات وأنظمة المعالجة الطبيعية العربية. وهذا البحث يتناول الجهود الناجحة التي تضمنت نهجًا قائمًا على القواعد لمختلف مهام معالجة اللغة العربية الطبيعية. وأحد الانتقادات المحتملة للنهج القائم على القواعد هو أنه موضوع تقليدي تمت دراسته على نطاق واسع خاصة عندما يتعلق الأمر باللغات الأوروبية. ومع ذلك، نظرًا لوضع تكنولوجيا اللغة العربية في الوقت الحاضر، لا يزال البحث الحالي يمثل خطوة نحو مساعدة تقنية اللغة العربية على اللحاق بتكنولوجيا اللغة الأكثر نضجًا مثل اللغة الإنجليزية.

وتُظهر التجربة أن التطور السريع للأنظمة المستندة إلى القواعد أمر ممكن، لا سيما في ظل غياب الموارد اللغوية والصعوبات التي تواجه تكييف الأدوات من اللغات الأخرى بسبب خصائص وطبيعة اللغة العربية. أخيرًا، تشير التجربة أيضًا إلى ضرورة اعتماد حلول عامة قدر الإمكان، حيث يزيد ذلك من فرص استخدام المعرفة والأدوات اللغوية في مجالات وأنظمة أخرى أيضًا.

التعقيب على الدراسات السابقة:

تشابه الدراسة الحالية مع الدراسات السابقة جميعها في تطرقها لموضوع الذكاء الاصطناعي ودوره واستثماره في إفادة اللغة العربية، عبر برمجة تطبيقات محوسبة تعتمد على الذكاء الاصطناعي، كما تشغل في البحث عن التطبيقات التي تفيد اللغة على مستوى معالجتها نحويًا وصرفيًا من خلال الحاسوب وبرامجه، وعمليات حوسبة اللغة وحوسبة المعاجم اللغوية وبرمجتها لتكون أكثر سهولة في يد الباحثين والدارسين، وتصيح عمليات البحث أكثر سهولة ويسر، خصوصًا مع المعاجم العربية الضخمة التي تشغل أجزاء من الكتب والمصنفات التي يعود معها أمر البحث في اللغة أمرًا بالغ التعقيد والصعوبة؛ بل منفردًا من اللغة عند الكثيرين، وفي هذا السياق تفيد الدراسة من كل المراجع التي استفادت منها الدراسات السابقة التي انشغلت مثلها في السياق البحثي نفسه.

لكن الدراسة الحالية تخصص مساحة كبيرة للبحث في هذا المجال ومناقشته، فهي دراسة دكتوراه، تعنى بدراسة مستفيضة لتطبيقات الذكاء الاصطناعي في معالجة اللغة نحويًا وصرفيًا، من خلال التطبيقات التي تمت فعليًا، والتطبيقات التي يمكن أن تتحقق ضمن هذا المجال، وما يحيط هذا الموضوع من قضايا وتحديات وصعوبات، وإبراز الوقائع الحالية والرهانات والاتجاهات المستقبلية في هذا الجانب.

منهج البحث وخطواته:

يعتمد الباحث في بحثه هذا على المنهج الوصفي التحليلي منهجًا نوعيًا في الوقوف على تطبيقات الذكاء الاصطناعي في معالجة اللغة نحويًا وصرفيًا، من خلال شرحه ومناقشته وتحليل آلياته، وجمع المعلومات والاستقصاء الدقيق عن كل الأمور التي تصب في جانب معالجة اللغة العربية نحويًا وصرفيًا، وغير ذلك من الأمور التي تفرضها طبيعة الدراسة في هذا الاتجاه، وذلك لا يمنع الاستفادة من أدوات بعض المناهج الأخرى متى ساهم ذلك في إفادة البحث، ووصله إلى مخرجات مهمة.

التصور العام لفصول الدراسة:

- المقدمة: وتحتوي على مشكلة الدراسة وحدودها وأهدافها وأهميتها ومنهجها ومصطلحاتها وأبرز الدراسات السابقة وخطة الدراسة المتبعة فيها.
- الباب الأول: الذكاء الاصطناعي... المفهوم والنشأة والخصائص والمنهج.
- الباب الثاني: اللغة العربية وحوسبتها... نشأة الفكرة، والأهمية والأساليب، وأهم المخرجات.
- الباب الثالث: الذكاء الاصطناعي وربطه باللغة العربية. الكيفية، والأهمية، ودوره ومنجزاته.
- الباب الرابع: تطبيقات الذكاء الاصطناعي في اللغة العربية _ معالجة اللغة نحويًا وصرفيًا. دراسة تطبيقية على نماذج تمت في هذا المجال.
- الخاتمة: فيها تلخيص لأبرز ما توصلت إليه الدراسة من نتائج وأهم التوصيات التي توصي بها.
- قائمة المصادر والمراجع: فيه قائمة الكتب والمراجع التي استفاد منها الباحث في دراسته.

قائمة المراجع:

أولاً- الكتب المنشورة:

- استخدام اللغة العربية في المعلوماتية. 1996. المنظمة العربية للتربية والثقافة والعلوم. تونس.
استيتة، سمير شريف. 2005. اللسانيات. المجال والوظيفة والمنهج. ط1. الأردن. عالم الكتب.
بن يوسف، حميدي. 2019. مفاهيم وتطبيقات في اللسانيات الحاسوبية. مركز الكتاب الأكاديمي.
بونيه آلان. 1993. الذكاء الاصطناعي واقعه ومستقبله. ترجمة: علي صبري فرغلي، الكويت: عالم المعرفة.
الجندي، فداء ياسر. 2003. العرب والعربية في عصر الثورة الحاسوبية. دار الفكر المعاصر.
خلاف، سيد محمد. 2020. حوسبة الأدوات النحوية حوسبة الأدوات النحوية "مقاربة نحو - مقارنة نحو - حاسوبية للأدوات المختصة وتراكيبها في القرآن الكريم". عالم الكتب.
علوي، حافظ إسماعيلي. 2009. اللسانيات في الثقافة العربية المعاصرة، دراسة تحليلية نقدية في قضايا التلقي واشكالاته. ط1. بيروت. دار الكتاب الجديد المتحدة.
علي، نبيل. 1988. اللغة العربية والحاسوب. ط1. الكويت. مؤسسة تعريب.
العناتي، وليد. (2003). اللسانيات التطبيقية وتعليم العربية لغير الناطقين بها. ط2. الأردن. دار الجوهرة للنشر.
العناتي، وليد؛ والجبر، خالد. 2007. دليل الباحث إلى اللسانيات الحاسوبية العربية. ط1. الأردن. دار للنشر والتوزيع.
الموسى، نهاد. 2000. العربية.. نحو توصيف جديد في ضوء اللسانيات الحاسوبية. ط1. بيروت. المؤسسة العربية للدراسات والنشر.

ثانياً- المجلات والدوريات:

- بوزوادة، حبيب. 2020. برامج الحاسوب ودورها في تعليم اللغة العربية برنامج الفراهيد أمودجا. أعمال الملتقى الوطني. اللغة العربية وبرامج الذكاء الاصطناعي الواقع والرهنات. المجلس الأعلى للغة العربية.
البياتي، فارس رشيد. 2019. الذكاء الاصطناعي لبرامج تعليم اللغة العربية في ظل الثورة الصناعية الرابعة. المؤتمر الدولي الثامن للغة العربية. كتاب الأبحاث. الكتاب الأول. (11-13 إبريل).
تلمساني، رضوان. 2020. التعرف الآلي والآني على أحرف اللغة العربية. أعمال الملتقى الوطني. اللغة العربية وبرامج الذكاء الاصطناعي الواقع والرهنات. المجلس الأعلى للغة العربية.
جمعة، عمرو. ٢٠١٦. تقنيات اللغة العربية الحاسوبية، معايير التقييم ورؤى التطوير، دراسة لغوية حاسوبية، مركز الملك عبد الله لخدمة اللغة العربية.

- الحناش، محمد. 2003. اللغة العربية والحاسوب قراءة سريعة في الهندسة اللسانية العربية"، مجلة التواصل اللساني، مج9. الخطيب، حسام. 1998. العربية في عصر المعلوماتية، تحديات عاصفة ومواجهات متواضعة. مجلة التعريب. المركز العربي للتعريب والترجمة والنشر. ع2.

- خياط، محمد غزالي؛ وهنادي محمد عبد القادر. 1993. تمثيل الدلالة الصرفية لأوزان الأفعال في النظم الآلية لفهم اللغة العربية. مؤسسة الملك عبد العزيز للدراسات الإسلامية. المغرب.

- الدخيسي، عبد الكريم. (2020). اللسانيات الحاسوبية والمعالجة الآلية للغة العربية. عالم الكتب الحديث.
- راغين، بوشعيب. 2007. الحوسبة التوليدية للصف العربي. الندوة الدولية الأولى عن الحاسب واللغة العربية. مدينة الملك عبد العزيز للعلوم والتقنية. الرياض.
- رشوان، محسن وآخرون. ٢٠١٩. مقدمة في حوسبة اللغة العربية، مركز الملك عبد الله لخدمة اللغة العربية.
- رضا، بابا أحمد. 2020. التوليد الآلي للجمل العربية بواسطة لغة الذكاء الاصطناعي. أعمال الملتقى الوطني. اللغة العربية وبرامج الذكاء الاصطناعي الواقع والرهانات. المجلس الأعلى للغة العربية.
- رضا، بابا أحمد. د.ت. اللسانيات الحاسوبية مشكل المصطلح والترجمة. مخبر المعالجة الآلية للغة العربية. جامعة تلمسان. الجزائر.
- زمولي، موسى. (2002). التجارب الراهنة حول حوسبة النصوص التي تعتمد اللغة العربية، المجلس الأعلى للغة العربية. ع7.
- سلطاني، خديجة الكبرى. 2020. الذكاء الاصطناعي: مداخله ومفاهيمه وأهم خصائصه وتطبيقاته، المعالجة الآلية للغة العربية. أعمال الملتقى الوطني. اللغة العربية وبرامج الذكاء الاصطناعي الواقع والرهانات. المجلس الأعلى للغة العربية.
- سليمان بلحسين. 2020. دور "الذكاء الاصطناعي" في تطوير البحث اللساني العربي. أعمال الملتقى الوطني. اللغة العربية وبرامج الذكاء الاصطناعي الواقع والرهانات. المجلس الأعلى للغة العربية.
- شنين، عبد الرحمن. 2020. تطبيقات المعاجم العربية المرفوعة على البلاي ستور، دراسة تحليلية. أعمال الملتقى الوطني. اللغة العربية وبرامج الذكاء الاصطناعي الواقع والرهانات. المجلس الأعلى للغة العربية.
- صالح، عبد الرحمن الحاج. 2007. النظرة الخليلية الحديثة مفاهيم أساسية. مركز البحث العلمي والتقني لتطوير اللغة العربية. الجزائر. ع4.
- صيني، محمود. 1992. نحو معجم عربي للتطبيقات الحاسوبية. ندوة استخدام اللغة العربية في تقنية المعلومات. الرياض.
- العارف، عبد الرحمن بن حسن. 2007. توظيف اللسانيات الحاسوبية في خدمة الدراسات اللغوية العربية - جهود ونتائج. مجلة مجمع اللغة العربية الأردني، ع73.
- عطية، محمد وآخرون. 2019. العربية والذكاء الاصطناعي. مركز الملك عبد الله بن عبد العزيز الدولي لخدمة اللغة العربية.
- عطية، محمد وآخرون. 2019. تطبيقات أساسية في المعالجة الآلية للغة العربية. مركز الملك عبد الله لخدمة اللغة العربية.
- علي، نبيل. 1987. اللغة العربية والحاسوب. مجلة عالم الفكر. مج18. ع13.
- عمر، ديدوح. 2009. فعالية اللسانيات الحاسوبية العربية، مجلة الآداب واللغات - جامعة قاصدي مرياح. الجزائر، ع8.
- العناتي، وليد. 2005. اللسانيات الحاسوبية العربية (المفهوم، التطبيقات، الجدوى). مجلة الزرقاء للبحوث والدراسات. مج7. ع2.
- فاهم، سعيد. 2015. قراءة في الإسهامات اللسانية الحاسوبية العربية آفاق ورهانات. مجلة دراسات الجامعة الأغواط، ع36.
- قمورة، سامية شهبهي؛ وباي، محمد؛ وكروش، حيزية. 2018. الذكاء الاصطناعي بين الواقع والمأمول دراسة تقنية وميدانية. الملتقى الدولي "الذكاء الاصطناعي: تحد جديد للقانون؟". الجزائر. (26-27 نوفمبر).
- كاظم، أحمد. 2012. الذكاء الاصطناعي. جامعة الإمام الصادق علي (عليه السلام). كلية تكنولوجيا المعلومات. قسم هندسة البرمجيات.
- كنالي، وحدان محمد صالح كنالي. 1434هـ. اللسانيات الحاسوبية العربية - المنهج والإطار. بحث قدم في المؤتمر الدولي الثاني للغة

العربية في دبي. (30/ جمادى الآخرة).

- اللغة العربية وتحديات القرن الحادي والعشرين. 1996. المنظمة العربية للتربية والثقافة والعلوم. تونس.
- الموسى، نهاد. 1990. اللغة العربية والحاسوب لنبييل علي. المجلة العربية للعلوم الإنسانية. جامعة الكويت. ع38. السنة 10.
- نصيرة، بن شيحة. 2020. الأنموذج الصوتي العربي ومسارات التحول من رحاب الذكاء الفطري إلى فضاء الذكاء الاصطناعي. أعمال الملتقى الوطني. اللغة العربية وبرامج الذكاء الاصطناعي الواقع والرهانات. المجلس الأعلى للغة العربية.
- هلال، يحيى. 1990. العلاج الآلي للعربية وتطبيقات. مجلة التواصل اللساني. مج2. ع2.
- أبو هيف، عبد الله. 2004. مستقبل اللغة العربية: حوسبة المعجم العربي ومشكلاته والتقنية أنموذجًا. مجلة التراث العربي. دمشق. ع93-94.
- الوعر، مازن. 2003. اللسانيات والحاسوب واللغة العربية. صحيفة رؤى الثقافية. ع4.

ثالثاً-المواقع الالكترونية:

- الأسدي، عدي غني. (2019). الذكاء الاصطناعي والنظم الخبيرة. جامعة بابل. كلية الإدارة والاقتصاد. <http://www.uobabylon.edu.iq/uobcoleges/lecture.aspx?fid=9&depid=3&lcid=82691>
- أمهان، طارق عبد الحكيم. 2017. اللسانيات الحاسوبية ومشكلة حوسبة اللغة العربية: خطوة باتجاه الحل. شبكة الألوكة.
- مراد، غسان. (2020). اللغة العربية والذكاء الاصطناعي. مؤسسة الفكر العربي. نشر على: <https://www.shorouknews.com/columns/view.aspx?cdate=22042020&id=f8629e01-4455-40d7-940b-e84fd0b6ea6e> تاريخ الاطلاع: 12 إبريل 2021. الاثنين.

الباحثان :

أحمد العثمان

حكيم زينل

UNIVERSITI
MALAYSIA
KELANTAN

تفعيل دور الجامعات في تعليم اللغة العربية عبر وسائل التواصل الاجتماعي
Activating The Role of Universities in Teaching Arabic Through Social Media

Omar Bin Md Din

Faculty of Languages, Al - Madinah International University,
omardindin@gmail.com

Abdul Ghani Bin Md Din

Faculty of Arabic Language, Sultan Abdul Halim Mu'adzam Shah,
drghani@unishams.edu.my

Rusdee Taher

Faculty of Islamic Sciences - Prince Songkla University, Thailand-
taherrusdee@gmail.com

ABSTRACT

This scholarly paper present a set of visions and recommendations for the activation of roles in universities in the teaching of Arabic through social media, the proposed ways and methods to implement and apply it, whether in Malaysia, Thailand or other countries, where social media plays a huge role in this age as it is influencing the human mind and understanding, and in developing their sciences and knowledge. These proposed programs and activities is mainly for assist and support the main programs in the teaching of Arabic at the local level in Malaysia as well as at the international level. This is due to the university's participation in the social aspect and contribute to the awareness of different communities - especially non -Arabic speaking Muslims, the need and importance of learning Arabic. Because it is primarily the language of the Islamic religion and legal rulings, and because of their urgent need for this language to establish the practice of their religion, such as performing prayer, reading the Qur'an and the Prophet's hadith, and understand the meaning in it, so that the legitimate purpose is achieved.

Keywords: Arabic language sciences, language skills, Facebook, Youtube, Social media

مستخلص البحث:

ستعرض هذه الورقة العلمية وتقدم مجموعة من الرؤى والمقترحات لتفعيل دور الجامعات في تعليم اللغة العربية عبر وسائل التواصل الاجتماعي، والطرق والوسائل المقترحة لتنفيذها وتطبيقها، سواء في ماليزيا أو تايلند أو غيرها من البلدان، حيث إن وسائل التواصل الاجتماعي لها دور كبير في هذا العصر في التأثير على عقول الناس وأفهامهم، وفي تنمية علومهم ومعارفهم. فهذه البرامج والأنشطة المقترحة تساعد وتساند البرامج الرئيسية في تعليم اللغة العربية على المستوى المحلي في ماليزيا أو العالمي، وذلك من باب مشاركة الجامعات في الجانب الاجتماعي، والإسهام في توعية المجتمعات المختلفة - وبخاصة المجتمعات المسلمة غير الناطقة بالعربية- بضرورة تعلم اللغة العربية وأهميته، لكونها في المقام الأول لغة الدين الإسلامي والأحكام الشرعية، ولحاجتهم الماسة لهذه اللغة لإقامة شعائر دينهم كأداء الصلاة وقراءة القرآن والحديث النبوي، وفهم ما فيهما من المعاني، حتى تتحقق المقاصد الشرعية. الكلمات المفتاحية: علوم اللغة العربية، المهارات اللغوية، الفيس بوك، اليوتيوب، وسائل التواصل الاجتماعي.

المقدمة

الحمد لله، والصلاة والسلام على رسول الله، أما بعد

تعد وسائل التواصل الاجتماعي من العوامل التي لها دور كبير في التأثير في عقول الناس وتغيير أفهامهم وقناعاتهم، وفي تنمية علومهم ومعارفهم، وما يلاحظ من أن المواقع التعليمية وبخاصة في تعليم اللغة العربية ليست كثيرة في شتى مواقع التواصل الاجتماعي؛ كاليوتيوب والفيس بوك والتويتير والتليقرام والواتس اب وغيرها، وإن وجدت فليس لها دور كبير في التعليم والتربية، أو لا تمتلك ذلك الأسلوب الناجع في تعليم اللغة العربية وإتقان مهاراتها، وهناك عزوف كبير من الناس عن متابعتها، والتعلم والاستفادة منها، ويتضح ذلك من قلة المشاهدات لها، أو قلة الإعجابات، وهي المقياس التي تقاس بها كثرة التفاعل من قلته لهذه المواقع، بينما تجد في المقابل أن المحتويات الهابطة والمبتذلة والسيئة والمواقع التي تنشر اللهو وتعتمد على أساليب الترفيه، تجد هذه المواقع عليها إقبال كبير من الناس وبخاصة الشباب وصغار السن، وهذا يدق ناقوس الخطر علينا -نحن معاشر المسلمين- لنبحث عن الحلول الناجعة في تغيير مفاهيم الشباب والناشئة للاستفادة من هذه التقنيات الحديثة ومواقع التواصل الاجتماعي فيما ينفع، وبخاصة في نشر العلوم والمعارف النافعة للإنسان في حاله ومستقبل حياته العلمية والعملية، ولنبحث عن أساليب التشويق والإثارة في عرض محتوياتنا العلمية والمعرفية، كما يبحث عنها من أراد نشر محتوياته المبتذلة أو الهابطة أو غير ذلك.

وستقدم هذه الورقة العلمية مجموعة من الرؤى والمقترحات في تعليم اللغة العربية عبر وسائل التواصل الاجتماعي، تقوم بتنفيذها الجامعات العلمية سواء في ماليزيا أو تايلند أو غيرها من البلدان الإسلامية أو العربية أو العالمية، وستخرج هذه الورقة إن شاء الله بمجموعة من المقترحات والرؤى والأفكار التي تعين على نشر اللغة العربية عبر وسائل التواصل الاجتماعي، واقتراح بعض البرامج والأنشطة التي تساعد وتساند البرامج الرئيسية في تعليم اللغة العربية على المستوى المحلي - ماليزيا أو تايلند- أو العالمي، وذلك من باب مشاركة الجامعات في الجوانب الاجتماعية، والإسهام في توعية المجتمعات المختلفة -وبخاصة المجتمعات المسلمة غير الناطقة بالعربية- بضرورة وأهمية تعلم اللغة العربية، وإتقان مهاراتها وعلومها المختلفة، لحاجة الكثير من الناس لها لتسيير حياتهم الاجتماعية والسياسية والاقتصادية، ولكونها في المقام الأول لغة الدين الإسلامي والأحكام الشرعية، ولحاجتهم الماسة لهذه اللغة لإقامة شعائر دينهم كأداء الصلاة وقراءة القرآن والحديث النبوي وفهم ما فيهما من المعاني، حتى تتحقق المقاصد الشرعية من العبادات.

أهمية الدراسة:

أهمية هذه الدراسة تتمحور حول الأمور الآتية:

1- أن اللغة ظاهرة علمية وثقافية وحضارية واجتماعية وسياسية، تقوى وتضعف بحسب اهتمام أهلها وتمسكهم بها، واعتزازهم بالتكلم بها، ومعرفة أسرارها، واللغة كذلك تعبر عن هوية الشخص، ودينه وعقيدته وعاداته وتقاليده، وتعبير عن انتمائه لها ولثقافتها وهويتها، وعدم إتقانه للغته فيه ضياع للدين والهوية، فلهذا سيكون الحرص على تعليم هذه اللغة ونشرها على نطاق واسع من باب الدعوة إلى الإسلام أولاً، وما يحويه هذا الدين من الآداب والأخلاق والقيم السامية، ثم السعي إلى تحسين أداء هذه اللغة لدى المتكلمين بها، بتطوير المهارات اللغوية الأربع: الاستماع والتحدث والقراءة والكتابة، ليتمكنوا

من ممارسة هذه اللغة بالشكل المطلوب، وقيموا شعائر دينهم كما نصت عليها أحكام الإسلام، ولتقوية المجتمعات المسلمة بانتمائها لهويتها.

- 2- تقييم جهود الجامعات في تعليم اللغة العربية عبر وسائل التواصل الاجتماعي.
- 3- استخدام وسائل التواصل الاجتماعي في نشر اللغة العربية بطرق إلكترونية شيقة ووسائل عصرية حديثة، فوسائل التواصل الاجتماعي حالياً يقبل عليها الكثير من الناس، وبخاصة الشباب وصغار السن، ولها تأثير قوي على عقول الناس وأفهامهم ومعارفهم وثقافتهم.
- 4- قلة وجود مواقع أو تطبيقات في وسائل التواصل الاجتماعي أو حسابات أو قنوات إلكترونية منسوبة للجامعات في العالم الإسلامي والعربي، تطرح مواداً لغوية تعليمية بطرق عصرية حديثة، مع ربط مجموعة مواقع إلكترونية مختلفة ببعضها، خدمة للغة العربية وللإسلام وللمجتمعات المسلمة، ونشراً للغة العربية.
- 5- محاربة انتشار استخدام العامية في وسائل التواصل الاجتماعي، وكذلك انتشار دمج الحروف العربية مع غيرها من اللغات في الكتابة.
- 6- اقتراح أوجه الدعم والرعاية والتبني لمثل هذه المشاريع التعليمية لتعليم اللغة العربية من قِبَل المؤسسات والشركات التجارية العامة والخاصة ورجال الأعمال، فيمكنهم دعمها مادياً أو بشرياً أو إدارياً أو بغير ذلك من أوجه الدعم، حتى تحقق أهدافها في المشاركة المجتمعية، ولضمان استمرار تعليم العربية في المجتمعات المسلمة.

إشكالية الدراسة:

بعد تصفح العديد من المواقع والحسابات الإلكترونية على مواقع التواصل الاجتماعي والبرامج المؤثرة على الناس على شبكة الإنترنت وبخاصة موقع الفيس بوك وموقع اليوتيوب؛ اتضح عدم وجود ذلك الدور الكبير والفعال للمؤسسات العلمية والتعليمية- وبخاصة الجامعات العلمية في الدول الإسلامية والعربية - تعنى بنشر اللغة العربية وتعليمها، والاستفادة من هذه المواقع والحسابات الإلكترونية للتنوع في تعليم العربية بصور وأساليب مختلفة، وقلة وجود المواقع المتخصصة لتعليم قواعد النحو والصرف والإملاء، أو تحسين وتطوير المهارات اللغوية الأربعة: الاستماع والتحدث والقراءة والكتابة، أو وجود مواقع تعتمد الطرق التقليدية المبنية على التلقين المباشر من المدرس، وكذلك قلة المبادرات بطرح الأفكار والمقترحات العملية التطبيقية لتعليم اللغة العربية عبر وسائل تواصل عالمية، وضعف المؤيدين والداعمين لمثل هذه المشاريع النافعة، فجاءت فكرة هذه الدراسة باقتراح مجموعة من البرامج والأنشطة التعليمية لتعليم العربية عبر وسائل التواصل الاجتماعي، تقوم بها الجامعات العلمية المحلية والعالمية، مع تقييم دور بعض وسائل التواصل الاجتماعي حالياً في نشر العربية.

أهداف الدراسة:

- 1- توضيح جهود الجامعات في نشر اللغة العربية عبر وسائل التواصل الاجتماعي، وتقييم أدائها.
- 2- اقتراح مجموعة من البرامج والأفكار التعليمية لتعليم اللغة العربية عن طريق الأقسام العلمية المتخصصة في الجامعات.
- 3- توضيح طريقة تنفيذ البرامج والمقترحات والأفكار التعليمية عن طريق الجامعات، مع تطبيق نماذج تعليمية عصرية لجذب المتابعين والمتدربين لمواقع التواصل الاجتماعي المختلفة.

4- بيان أوجه الدعم من الجهات المختلفة لتنفيذ البرامج والأفكار التعليمية للغة العربية للإسهام والمشاركة في الجوانب الاجتماعية.

الدراسات السابقة:

لم يجد المعدون لهذا البحث دراسة بهذا العنوان والمضمون يرمي إلى اقتراح رؤى تعليمية تطبيقية عملية لتعليم اللغة العربية، على وسائل التواصل المختارة، مع ربط وسائل التواصل الاجتماعي ببعضها في تعليم اللغة العربية، وتفعيل دور الجامعات في هذا الأمر، وجُلّ ما وقفت عليه الدراسة ما هو إلا وصف لاستخدام وسائل التواصل الاجتماعي في التعليم بعامه، وليس استخدامها في تعليم اللغة العربية للمرحلة الجامعية بخاصة، أو وصف الأثر الذي تحدثه وسائل التواصل على الطلبة الجامعيين في تحصيلهم العلمي. أو وصف لطريقة استخدام مواقع التواصل في بعض الإجراءات التعليمية للمراحل التي قبل المرحلة الجامعية، أو استخدام وسائل التواصل الاجتماعي في التعليم بشكل عام، أو استخدامها في المجالات الأخرى من الحياة، وهذا هو الأكثر في الأبحاث والدراسات والمقالات. ومن الدراسات أو المقالات التي أشارت إلى الأمور السابقة ما يأتي:

1. دور مواقع التواصل الاجتماعي في دعم التعليم عن بعد لدى الطلبة الجامعيين، إعداد: الدكتورة سامية عواج والاستاذة تيري سامية، من كلية الإعلام والاتصال، بجامعة سطيف الجزائر، وقدم في المؤتمر الدولي الحادي عشر لمركز جيل البحث العلمي حول التعلم بعصر التكنولوجيا الرقمية والذي نظمه الاتحاد العالمي للمؤسسات العلمية بالتعاون مع جامعة تيبازة في طرابلس لبنان أيام 22 و23 و24 أبريل 2016.
 2. استخدام الطلبة الجامعيين لمواقع التواصل الاجتماعي، للباحث أسامة بن غازي مدني، الأستاذ في قسم الإعلام، بكلية العلوم الاجتماعية، بجامعة أم القرى بمكة.
 3. أثر استخدام وسائل الإعلام الجديدة في جامعة ظفار، للباحثين: خالد حامد فاضل البخيت، وأسامة كناكر، وهو بحث منشور في مجلة الاتصال والإعلام الإسلامي المعاصر، في جامعة العلوم الإسلامية بماليزيا.
 4. أهم 5 فوائد لاستخدام وسائل الإعلام الاجتماعي في المؤسسات التعليمية، وهي مقالة منشورة على الانترنت. ومن الأبحاث والمقالات ما وصفت ضعف اللغة في وسائل التواصل الاجتماعي بخاصة، والإعلام بعامه، ونقد انتشار العامية أو التساهل في استعمال العربية، من دون إبداء لمقترحات وحلول تطبيقية عصرية، وهي كثيرة، ومن ذلك: بحث (لغة الإعلام) لتمام حسان، وبحث (مستقبل اللغة العربية) لعبدالعزیز التوجيري، وكتاب (أثر وسائل الإعلام المسموعة والمرئية والمقروءة في اللغة العربية) لجابر قميحة، وغيرها من الكتب والأبحاث.
- ومن الباحثين من عمد إلى تحليل لغة الإعلام وتأثيرها في المتلقين، ومن ذلك: بحث (سلطة الكلمة في الفضاء الإعلامي المعاصر؛ دراسة لغوية تحليلية) لسيروان أنور مجيد، وكذلك بحث (ظواهر صرفية معاصرة في وسائل الإعلام الخليجية) لليلي خلف السبعان.
- ومن الباحثين من تعرض إلى تجربة تعليم اللغة عن طريق الدراما والتمثيل بطريقة تطبيقية في قاعة التدريس، وليس عن طريق وسائل التواصل المرئية، ومن ذلك بحث (أثر استخدام الدراما التعليمية في تدريس قواعد اللغة العربية في تحصيل طالبات الصف العاشر الأساسي) لأمين الكخن ولينا هنية.

منهج الدراسة:

ستنتهج الدراسة على المنهجين الوصفي والتحليلي، حيث سيتم وصف الحالة العامة لدور الجامعات والمؤسسات العلمية والتعليمية في تعليم اللغة العربية عبر وسائل التواصل الاجتماعي. أما المنهج التحليلي فسيأخذ الحيز الأكبر من الدراسة، وسيكون في عرض الأفكار والمقترحات المناسبة لتعليم اللغة العربية عبر مواقع التواصل الاجتماعي، مع توضيح وتحليل طريقة الأداء والتنفيذ لهذه البرامج من قبل المتخصصين وفرق العمل بالجامعات، واقتراح طريقة دعم الجهات المختلفة الراغبة في المشاركة في مثل هذه البرامج.

فصول البحث:

المقدمة: وفيها أهمية الدراسة وإشكالياتها، وأهدافها والدراسات السابقة ومنهجها.

تمهيد: وفيه مطلبان:

المطلب الأول: أهمية مواقع التواصل الاجتماعي في هذا العصر، وتأثيرها على النتاج العلمي والثقافي
المطلب الثاني: دور الجامعات الإسلامية والعربية في نشر اللغة العربية عبر مواقع التواصل الاجتماعي.

مبحث: مقترحات تعليمية تطبيقية لتعليم اللغة عبر وسائل التواصل، وفيه خمسة مطالب

المطلب الأول: تعليم العربية بالصور والنماذج المختصرة

المطلب الثاني: تعليم العربية عن طريق مقاطع الفيديو التثقيفية

المطلب الثالث: تعليم العربية بالتطبيق العملي

المطلب الرابع: إقامة المسابقات العلمية والثقافية اللغوية

المطلب الخامس: إقامة أسبوع ثقافي وحفل ختامي سنوي

المطلب السادس: دعوة الجهات والمؤسسات التعليمية والتربوية والتجارية لتبني المشروع ودعمه

الخاتمة والمصادر والمراجع

تمهيد :

المطلب الأول: أهمية مواقع التواصل الاجتماعي في هذا العصر، وتأثيرها على النتاج العلمي والثقافي

مما لا شك فيه أن انتشار لغة ما، وتمكنها في بعض المجتمعات أو البلدان والدول أو القارات يدل على قوة أهلها المتكلمين بها، وقوة حضارتهم وثقافتهم، بل يدل على القوة السياسية والاقتصادية لتلك الأمة كما هو الحال الآن في بعض اللغات كالإنجليزية مثلاً (العيصائي، 2010، ص: 109).

ويلحظ في هذه العصور المتأخرة الضعف في استخدام اللغة العربية الفصحى في شتى مجالات الحياة، وبخاصة في الدول العربية، وقد يعود ذلك إلى أسباب كثيرة منها: قلة الحاجة إلى اللغة العربية الفصحى في تفسير أمور الحياة اليومية، وقضاء الحاجات والمصالح الخاصة، وتعلق تلك المصالح باللغات الأخرى كالإنجليزية أو غيرها (العيصائي، 2010، ص: 109-110)، وضعف تعلق المسلمين والمتكلمين بالعربية بالمصادر الأساسية للغة العربية الفصحى وهي: القرآن الكريم والحديث النبوي الشريف، والتراث العربي شعراً ونثراً، وما يتعلق بها من مؤلفات ومصنفات؛ ظناً منهم بعدم جدواها وفعاليتها في قضاء المصالح والحوائج اليومية،

ولوجود وسائل أخرى وأساليب ومتعلقات أقوى منها لجلب تلك المصالح، وبخاصة ما يتعلق باستخدام وسائل التواصل الاجتماعي والحسابات الإلكترونية بخاصة، والشبكة العالمية بعامه.

وهكذا دبّ الضعف والهوان في اللغة العربية، وضعف انتشارها، واستبدلت بألفاظ وأساليب وتراكيب لم تعرف سابقاً عند الأعراب الفصحاء الأقحاح، وتهاون الناس في استخدامها والتكلم بها، فظهرت الازدواجية اللغوية (الفصحى والعامية)، وكذلك الازدواجية في استخدام الكلمات العربية ودمجها مع الكلمات والحروف الأجنبية في محادثات الناس وكتاباتهم، وبخاصة على وسائل التواصل الاجتماعي، أو الإعلام الجديد (العيثائي، 2010، ص: 112-113).

وقد استفادت اللغات الأجنبية كثيراً من مواقع التواصل الاجتماعي، والإعلام الجديد، والشبكة العالمية الإلكترونية؛ في تعليم الناس لغاتهم ولهجاتهم، ليقينهم بأن تلك المواقع الإلكترونية أصبحت ذات تأثير عال وقوي في توجيه الناس، وتثقيفهم وتعليمهم، وتغيير قناعاتهم وآرائهم، الأمر الذي يسهل عليهم نشر حضارتهم وثقافتهم، وفرض هيمنتهم الثقافية والاجتماعية والاقتصادية والسياسية على الناس (لافي، 2006، ص: 292-293).

وهناك دراسات عديدة أشارت إلى قوة تأثير وسائل الإعلام الجديد، أو وسائل التواصل الاجتماعي في حياة الناس وثقافتهم وسلوكياتهم وتصرفاتهم، وأضحت هذه الوسائل متعلق الناس في كثير من شؤون حياتهم، يقضون بها حوائجهم ومصالحهم اليومية، وسيتم توضيح ذلك في موضعه من البحث.

ولما سبق كله جاءت هذه الدراسة مع ما فيها من زوى ومقترحات تطبيقية تعليمية للاستفادة من وسائل التواصل الاجتماعي في تعليم اللغة العربية، ونشرها بين الناس، على نطاق جغرافي واسع، حتى تؤدي الجامعات الإسلامية والعربية دورها المناط بها في نشر العربية الذي يبني عليه نشر الإسلام، لعنا نستعيد ذلك المجد العظيم، والحضارات الراقية، والتاريخ المجيد الذي خلفته لنا الأمة الإسلامية والعربية الماضية، حيث أثبتت بعض الدراسات أن استخدام وسائل التواصل الاجتماعي في التعليم يساعد على تحسين المخرجات التعليمية، وتطويرها، ويكسب الطلبة قوة التركيز وجودة المتابعة للدروس، وقوة الاستيعاب لها (هندي، 2022، ص: 9-10، ولافي، 2006، ص: 292-293).

ووسائل التواصل الاجتماعي: هي مواقع وتطبيقات إلكترونية تفاعلية، أنشئت لأغراض اجتماعية مختلفة؛ كالمحادثة، والبحث عن الأصدقاء، والتعبير عن المشاعر والأحاسيس الخاصة، ومشاركة الآخرين في أفكارهم واهتماماتهم، ثم استخدمت بعد ذلك في مجالات شتى؛ علمية وثقافية واقتصادية وسياسية وغير ذلك.

ولا شك أن تلك الوسائل، أو ما يسمى بالإعلام الجديد أصبحت ذات تأثير قوي في عقول الناس وثقافتهم ومعارفهم، بل في سلوكياتهم وتصرفاتهم ومعتقداتهم وأخلاقهم، وقد حصل هذا التأثير الكبير من قبل هذه الوسائل لشدة تعلق الناس بها من حيث (العيثائي، 2010، ص: 109، والحيلة، 2007، ص: 382، والتودري، 2005، ص: 50):

- 1- تعدد أساليب نقل المعلومة: من صور ومقاطع مرئية، ومحادثات كتابية، وتناقل الملفات الحاسوبية المختلفة
- 2- سهولة استخدام تلك المواقع، لتوفرها على أجهزة الاتصال المحمولة، أو على الأجهزة الحاسوبية
- 3- سرعة الاتصال والتواصل مع الآخرين في أي مكان بالعالم
- 4- توفر المصادر المختلفة للمعلومات
- 5- الحصول على المعلومات الجديدة والأخبار الحديثة أولاً بأول
- 6- سهولة التعبير عن الآراء الشخصية من دون قيود
- 7- وجود أساليب التشويق والإثارة وجذب المتابعين
- 8- اتخذ الكثير من الناس وسيلة للعمل ومصدراً للدخل والتجارة

وهناك تجارب جيدة للغرب في استخدام وسائل التواصل الاجتماعي والحسابات الإلكترونية في التعليم، وأدت إلى نتائج باهرة، ومن ذلك دراسة (تيتير teeter) التي أجريت ونفذت على مجموعة من الطلبة في أمريكا، للتعلم في إحدى المقررات الدراسية، حيث تم تطبيق طريقة التعلم على بعض المواقع الإلكترونية، فأبدى الطلاب تفاعلاً جيداً مع الوسيلة الإلكترونية المستخدمة، وكان تحصيلهم عالياً في هذا المقرر، وتم تطبيق التمرينات على تلك المواقع، واستخدم الطلاب مهارات الاستماع والنقاش والردود على أفضل وجه. (Teeter. 1997)

ولهذا فإن تطبيق تعليم اللغة العربية على هذه الوسائل الحديثة بطرق وأساليب عصرية تقنية؛ سيكون له مردود إيجابي إن شاء الله في تعليم العربية وعلومها المختلفة لشريحة كبيرة من المستهدفين، وتحسين تعامل الناس والمتعلمين بها في كافة شؤون حياتهم، ولكن ذلك يحتاج إلى عزيمة وإصرار وتفان في تحقيق الأهداف المنشودة؛ بالإعداد والتخطيط والتنظيم السليم والجيد، ووضع البرامج والفعاليات المناسبة، واختيار الكفاءات والخبرات المؤهلة للتخطيط والتنفيذ (الخولي، 1987، ص: 46).

وقد خرج المؤتمر العالمي لتعليم اللغة العربية لغير الناطقين بها، والمنعقد في جامعة الملك سعود (جامعة الملك سعود، 2009، ص: 292) إلى مجموعة توصيات متعلقة باستخدام التقنيات الحديثة في تعليم العربية، ومن تلك التوصيات: ضرورة استخدام وسائل التواصل الاجتماعي والتقنيات الحديثة والمواقع الإلكترونية، والاستفادة منها في تعليم اللغة العربية.

المطلب الثاني: دور الجامعات الإسلامية والعربية في نشر اللغة العربية عبر مواقع التواصل الاجتماعي.
تعد المشاركة المجتمعية من الأهداف والأدوار المهمة التي تتركز عليها الجامعات العالمية الكبيرة، ذات السمعة العالية، والأداء المتميز، ولا تقتصر فقط على التعليم النظري والتطبيقي في قاعاتها، ولا على إجراء البحوث والدراسات والاختبارات في كلياتها ومعاملها وإداراتها.

ونشر اللغة العربية يعدّ من أساليب المشاركة المجتمعية التي تقوم بها المؤسسات والمراكز العلمية والتعليمية، لتحقيق مجموعة من الأهداف السامية للمسلمين، بل وغير المسلمين، وبخاصة في هذا الزمن الذي طغت فيها اللغات الأجنبية غير العربية - وبخاصة الإنجليزية - على اللغة العربية، وكذلك فشو اللهجات المحلية والعامية على السنة المسلمين والعرب، حتى إذا سمع أحدهم اللغة العربية الفصحى لا يكاد يفهم الكثير من كلماتها وجملها، وهذا يعود بالضرر على الدين والثواب التي دعت إليها الشريعة الإسلامية للتمسك بها، وتعاهدتها باستمرار، وتذكير الناس بها، فضياع العربية الفصحى يترتب عليه ضياع الدين وأحكامه، وغربتها، مع انتشار البدع والخرافات، وسهولة التغيير والتحريف في الأحكام الشرعية الصحيحة.

وإن أمعنت النظر في جهود الجامعات في الدول الإسلامية والعربية في نشر اللغة العربية عبر وسائل التواصل الاجتماعي وتطبيقاتها، وابتكار الأساليب والطرق المختلفة لتعليمها؛ لا تجد ذلك الدور الكبير لها، إلا بعض الاجتهادات من بعض الكليات أو الأساتذة، ولا يكاد يتعدى المستهدفون طلبتها. بل قد لا تجد لها دوراً في نشر اللغة العربية أصلاً (المقالح، 2009)، بغض النظر عن استخدام مواقع التواصل الاجتماعي والتقنيات الحديثة في ذلك، مع أن مواقع التواصل الاجتماعي - كما أسلفنا آنفاً - أصبحت ذات تأثير عالٍ في عقول الناس وأفهامهم وثقافتهم، وأصبحت ميداناً خصباً للتعليم ونشر العلم والمعرفة والثقافة، وتتخطى الحواجز الزمانية والمكانية لتحقيق ذلك.

ويلاحظ أن الكثير من الجامعات في الدول الإسلامية والعربية تحتم اهتماماً بالغاً بتدريس اللغات الأجنبية وبخاصة الإنجليزية بحجة أنها لغة العصر، وأن العلوم البحتة المعاصرة لا تُدرّس إلا بها، كالطب والهندسة وغيرها، فتجد إتقان الطالب المسلم العربي للغة الإنجليزية أكثر من إتقانه للعربية (الزامل، 2012).

وكما تمت الإشارة إليه آنفاً في الدراسات السابقة فلا توجد دراسة أو بحث أو كتاب أو تقرير يصف بشكل دقيق دور الجامعات في تعليم اللغة العربية باستخدام وسائل التواصل الاجتماعي، أو يقترح طرقاً معينة لاستخدام وسائل التواصل الاجتماعي

في تعليم العربية، وما كتبه بعض الباحثين لا يتعدى وصفهم للأثر الذي تحدثه وسائل التواصل على الطلبة الجامعيين في تحصيلهم العلمي، أو وصف لطريقة استخدام مواقع التواصل في بعض الإجراءات التعليمية للمراحل التي قبل المرحلة الجامعية، أو استخدام وسائل التواصل الاجتماعي في التعليم بشكل عام، أو استخدامها في المجالات الأخرى من الحياة.

مبحث: مقترحات تعليمية تطبيقية لتعليم اللغة عبر وسائل التواصل

تعدد وسائل التعليم واختلاف أنواعها من الأمور المهمة جداً في عملية التعليم؛ لما في ذلك التعدد من التشويق في التعلم، وسرعة وصول المعلومة بطرق متميزة، وتمكن المعلومة في ذهن المتلقي.

كما أن وسائل التواصل المذكورة سابقاً في البحث أصبح لها تأثير كبير جداً في تنقيف الناس وتعليمهم والتأثير فيهم؛ لما فيها من السهولة في الاستخدام، ولوجود أساليب متنوعة فيها تشد انتباه المشاهد والمتابع، وتعلّقهم بها، وقد ذُكرت الأسباب سابقاً. وفيما يأتي توضيح لبعض المقترحات التي يمكن من خلالها تعليم الناس قواعد اللغة العربية -نحواً و صرفاً وإملاءً- وكذلك المهارات اللغوية الأساسية بطرق جيدة وسهلة، تناسب المبتدئين والمتوسطين والمتقدمين في تعلم علوم اللغة العربية ومهاراتها، وتكون متنوعة كذلك، بعيدة عن الطرق التقليدية التي قد يتلقاها الطالب في قاعات الدراسة في المراحل المختلفة. وفي هذا المبحث ستة مطالب:

المطلب الأول: تعليم العربية بالصور والنماذج المختصرة.

يقصد بهذا المقترح هو تعليم اللغة العربية بإعداد وتصميم صور متنوعة، تحوي معلومات متعددة عن الموضوع الواحد، ويتم شرحه بطريقة مبسطة، وتوضع تلك المعلومات داخل أشكال ورسومات وصور متنوعة، جذابة، عصرية، ذات ألوان جميلة، ويصمم على أحد البرامج المعروفة حالياً مثل: الفوتوشوب، والبوربوينت وغيرهما، وهناك بعض الطرق الجيدة لتصميم هذه الصور التعليمية تسمى بـ(الإنفو جرافيك)؛ وهي الصور التي تحتوي على معلومات علمية عن قضية ما، وتحتوي معلومات متعددة عن هذه القضية، في تصميم جذاب وعصري، سهل القراءة والاستيعاب.

ويمكن أن تكون مواضيع الصور متسلسلة تدور حول موضوع لغوي معيّن، وبخاصة في المواضيع التي تستهدف تعليم العربية للناطقين بغيرها، فتُقدم المعلومات التعليمية بطرق شيقة عن طريق الصور التي تحتوي على المعلومات أو القصص، وتُقدم بطريقة متسلسلة إلى الانتهاء من موضوع معيّن، ثم يُنتقل إلى موضوع آخر وسلسلة جديدة.

ومن فوائد التعليم بالصور والنماذج المصورة المصممة المختصرة:

- 1- شد انتباه المتعلم إلى المعلومة بحيث ترسخ في ذهنه.
- 2- المتعة في التعليم وإيصال المعلومة، وبخاصة للناطقين بغير العربية الذين يحتاجون إلى التسهيل والتيسير والتشويق في عرض المواد التعليمية.
- 3- الاختصار في عرض المعلومات المتعلقة بالموضوع الواحد.
- 4- جمع أكبر قدر من المعلومات المهمة في الموضوع الواحد في صورة واحدة، ومكان واحد، وهو أدعى إلى استيعاب التفاصيل المهمة للموضوع بصورة أشمل وأسرع، وبخاصة إن كانت هذه المعلومات تتعلق بقواعد النحو والصرف والإملاء التي تحتاج إلى حصر وضبط واستيعاب

المطلب الثاني: تعليم العربية عن طريق مقاطع الفيديو التثقيفية:

وهذا النوع ذو شقين:

أ- عرض الدرس كاملاً.

ب- التعليم بالبت المرئي المباشر.

أ- عرض الدرس كاملاً مسجلاً:

ويكون ذلك بإعداد عرض بوربوينت كامل عن موضوع لغوي محدد في علوم اللغة، أو موضوع لتطوير المهارات اللغوية الأربعة: الاستماع والقراءة والكتابة والتحدث، أو تستخدم الصور التوضيحية التي تحتوي على معلومات تعليمية، وبخاصة في دروس تطوير المهارات اللغوية، ثم يعدّ تسجيلاً بالصوت والصورة عن طريق برامج الفيديو، ويتم شرح الموضوع كاملاً بشكل مبسط وواضح، مع عرض الأمثلة المناسبة، وربط الدرس بما يتعلق به من الدروس الأخرى باختصار، ويجادل قدر المستطاع ألا يتعدى الشرح أكثر من 20 إلى 30 دقيقة.

وتكون دروس الموضوع الواحد متسلسلة ومتتابعة، مع ترقيم العناوين ترقيماً جيداً، وتوضيح الدروس والحلقات المرتبطة بالموضوع الواحد - كالفعل مثلاً- بأنها في 4 أو 5 حلقات، ويكتب ذلك في الوصف الخاص بالفيديو.

ثم تنشر هذه المادة اللغوية المرئية على الحساب المخصص على قناة اليوتيوب وكذلك على حساب الفيس بوك والتليقرام. ويقترح كتابة منشورات توضح على الفيس بوك وغيرها من المواقع المساندة كالتليقرام والتويتير والإنستغرام؛ توضح بأن حلقات ودروس النحو -مثلاً- موجودة على موقع اليوتيوب، ومرتببة بحسب الأبواب، وفي كل باب عدد معين من الحلقات، وتوضع معها روابطها الإلكترونية لتسهيل الدخول على الحلقات.

ويكون تسجيل هذه الدروس عن طريق أحد البرامج والتطبيقات الإلكترونية، مثل: (ZOOM) و (Google Meet) و (Microsoft Teams) أو غيرها من برامج المحادثة.

ب- التعليم بالبت المرئي المباشر:

وهذه الطريقة تشبه الطريقة الأولى في إعداد عرض بوربوينت عن موضوع لغوي، ولكن الدرس هنا يعرض مباشرة عن طريق إحدى برامج البث المباشر المتعلقة ببعض التطبيقات، مثل: البث المباشر عن طريق موقع اليوتيوب، والفيسبوك، أو استخدام برنامج البيرسكوب (periscope) المرتبط بموقع تويتير، أو استخدام برامج الاتصال الإلكترونية الحديث مثل برنامج (ZOOM) و (Google Meet) و (Microsoft Teams) أو غيرها من برامج المحادثة. وميزة هذه البرامج الثلاثة الأخيرة أنه يمكن للمعلم أن تعرض شرائح البوربوينت مباشرة على صفحة المشاهدة، أو يعرض المتحدث صورته إن شاء التحدث إلى المستمعين، وفيهما ميزة أخرى كذلك وهي أنه يمكن للمشاهدين والمتعلمين أن يناقشوا المعلم، ويسألوه عن بعض ما يشكل عليهم في الدرس عن طريق المحادثة المباشرة، أو الكتابة في المكان المخصص للتعليقات والمدخلات، كما يمكنها تسجيل اللقاءات المباشرة ثم إرسالها لمن أراد الاستماع إلى الدرس مرة أخرى.

كما يتميز برنامج (ZOOM) بأنه يمكن استخدامه ربطه مع حساب الفيس بوك، فيكون النشر على الموقعين. وفي هذا النوع لا بد أن يحدد موعد إلقاء الدرس باليوم والساعة؛ حتى يتمكن المستمعون والمتعلمون من التفرغ والاستعداد للاستماع، ويستحسن كذلك أن تكون مدة الدرس من 20 إلى 30 دقيقة، وبعدها يفسح المجال للنقاش. وعليه فينبغي للقائمين على البرنامج أن يُعدّوا للبرامج التعليمية بعناية فائقة، وأن يحددوا تواريخ الدروس لمدة ثلاثة أشهر على أقل تقدير، إن لم يكن لمدة عام كامل،

وتحدد كذلك مواعيد التدريب والتطبيق العملي، ومواعيد الاختبارات والتقييم، والحسابات التي سيتم نشر المواد التعليمية عليها، وغير ذلك من متعلقات البرامج التعليمية.

ومن الأهمية بمكان أن يتم تسجيل هذه المحاضرات والدروس المباشرة، وتُنظَّم الدروس والحلقات وتكون مرتبة، ويقيد ذلك ويعلن في حسابات معينة كالفيس بوك أو الانستغرام أو التويتز وغيره من المواقع.

المطلب الثالث: تعليم العربية بالتطبيق العملي:

من الأمور المهمة لإتقان لغة ما هو انغماس المتعلم في اللغة، واستخدام اللغة الهدف في الحياة اليومية، وتطبيق ما يؤخذ في الفصول والحصص المخصصة للتعليم في واقع الحياة، وبهذا تكون الجهود المبذولة في التعليم وبناء المناهج المخصصة لتعليم اللغة العربية - علومها ومهاراتها- قد آتت أكلها.

وهناك مقترجان لتنفيذ هذا النوع العملي من التعليم وهما:

المقترح الأول: تمثيل الأدوار المقترح الثاني: المحادثة اليومية

المقترح الأول: تمثيل الأدوار:

ويقصد بذلك أن يقوم المعلم بتدريب الطلبة على محاكاة الحياة اليومية التي يعيشها الإنسان العربي، سواء في بيته أو سوقه أو مدرسته ومكان تعليمه، أو في عمله أو غير ذلك من تفاصيل الحياة اليومية. وهذا التدريب ينفع كثيراً في تطوير المهارات اللغوية الأربع للطلبة.

ويكون تطبيق هذا التدريب بالأمور الآتية:

- 1- يختار المعلم المواضيع المناسبة للحوار بين المتعلمين.
- 2- يعد المعلم الحوار الذي يدور بين شخصين أو أكثر، ويكتب الحديث الذي يدور بين المتحاورين بحسب مستوياتهم، أو يعد فريق العمل ذلك، بشرط أن يكونوا من المتخصصين في اللغة العربية.
- 3- تُقسَّم المواضيع على الطلبة في الفصل، كل مجموعة موضوع معين، ويتم تطبيق هذا التدريب بشكل مستمر، ويمكن أن يكون في يومين أو ثلاثة أيام في الأسبوع الواحد.
- 4- يتم تطبيق هذا التدريب على أحد البرامج الإلكترونية في البث المباشر والمحادثة المباشرة، مثل برنامج (ZOOM) و (Google Meet).
- 5- يعلن عن هذا التدريب قبل تطبيقه بمدة كافية، ويمكن أن يوضع جدول لمدة شهرين أو ثلاثة للتدريب الأسبوعي، ويكون معلناً عنه في وسائل التواصل الاجتماعي المرتبطة بالبرنامج التعليمي التدريبي؛ كالفيس بوك أو التويتز أو الانستغرام.
- 6- أن يستمر التدريب لمدة ثلاثة أشهر.

المقترح الثاني: المحادثة اليومية:

وهذا التدريب أو الممارسة اليومية للمحادثة يساعد المتعلم على إتقان اللغة العربية وتطوير المهارات اللغوية الأربع، ويتم تطبيقه عبر وسائل التواصل الاجتماعي على بعض البرامج التي يكون فيها تفاعل كبير بين المتعلمين، مثل برنامج الواتس أب، أو يكون بطريقة التواصل المرئي المباشر بين المتعلمين، عن طريق الاتصال الجماعي عبر برنامج الواتس أب كذلك أو غيره من برامج الاتصال الجماعي.

ويمكن أن نحدد وقتاً معيناً فيكون مرتين أو ثلاث مرات في الأسبوع، ليتم التواصل بين المتعلمين عن طريق البرنامج المخصص لذلك، ويكون الحديث باللغة العربية الفصحى، بشرط أن يكون مستوى المتعلمين متقارب، وفي مستوى تعليمي واحد، حتى تكون الفائدة أكبر بسبب المحاولة في الكلام والتحدث.

ويقوم المعلم كذلك بالتحدث والتحاور معهم، وفتح مواضيع مختلفة للحديث، ويمكن تحديد هذه المواضيع مسبقاً، ويعلن عن هذه المواضيع قبل البدء بالبرنامج بفترة، ويطلب من الطلبة التحضير للكلام في هذا التدريب المباشر، بتحضير الكلمات والجمل المناسبة للحديث.

كما يقوم المعلم بدور المقيم والمصحح للأخطاء اللغوية والأسلوبية، ويستمر على هذا التدريب لمدة 3 أشهر تقريباً، ثم يقوم المعلم بتقويم مستوى الطلبة من خلال هذا التدريب، وكذلك التدريب السابق وهو تمثيل الأدوار؛ بعقد الاختبارات الفردية أو الجماعية لقياس مستوى جودة الكلام واستخدام الألفاظ وإخراج الحروف بالشكل المطلوب.

المطلب الرابع: إقامة المسابقات العلمية والثقافية اللغوية.

وهي فعاليات وبرامج مساعدة في تعليم اللغة العربية، ويكون ذلك بإعداد مجموعة من المسابقات العلمية والثقافية والترفيهية، وتعرض في بعض الحسابات المتعلقة بالجامعة، وتكون الأسئلة ضمن المواضيع والدروس التي تم بثها وإلقاؤها على الحسابات المختلفة، وذلك لقياس مدى استيعاب المتعلمين للدروس، وللتشويق والتحفيز على متابعة برامج الجامعة وأنشطتها على حساباتها المختلفة على وسائل التواصل الاجتماعي، وللتشجيع على تعلم العربية وإتقان أبوابها ومسائلها وأمثلتها، ويقترح أن تقيم الجامعة المسابقات الآتية، وهي على ثلاثة أقسام:

القسم الأول: مسابقات قياس المهارات اللغوية.

1- مسابقة أفضل قارئ.

2- مسابقة المشاهد التمثيلية.

القسم الثاني: مسابقات العلوم العربية

1- مسابقة علمية بحثية.

2- مسابقة الإلقاء والخطابة.

3- المسابقة الثقافية اللغوية الكبرى بين الفرق.

القسم الثالث: مسابقات قياس المهارات اللغوية والعلوم العربية.

1- مسابقة لغوية تحريرية.

2- مسابقة لغوية إلكترونية قصيرة.

3- المسابقة الثقافية اللغوية الكبرى بين الجامعات

وتفصيل طريقة تنفيذ المسابقات ستكون بالخطوات والإجراءات الآتية:

القسم الأول: مسابقات قياس المهارات اللغوية.

ويقصد بها المسابقات التي توجه للطلبة غير الناطقين بالعربية، وذلك لقياس مهاراتهم اللغوية الأربع، ومدى إتقانهم لها، واستفادتهم من المواد التعليمية المقدمة لهم في البرامج التعليمية بالجامعة على مواقع التواصل الاجتماعي، ويقترح في هذا القسم المسابقات الآتية:

1- **مسابقة أفضل قارئ:** ويتم تطبيق هذه المسابقة لقياس المهارات اللغوية الأربع للطلبة، وتصلح للمبتدئين والمتوسطين في تعلم العربية، وطريقة تنفيذ هذه المسابقة أن يعرض على أحد حسابات الجامعة نص معين، سواء من القرآن الكريم أو الحديث النبوي أو الشعر أو النثر الفصيح، ثم يطلب من المشاركين تسجيل مقاطع مرئية صوتية وهم يقرؤون ذلك النص، على أن يكون القارئ هو المشارك نفسه، وذلك بالتأكد من هويته التي يرسلها مع مشاركته، على أن يكون القارئ من غير الناطقين بالعربية، ويتم تقويم أفضل قارئ للنص، ثم يُكرم المشارك الفائز بجائزة محددة من قبل إدارة الجامعة، وترسل له الجائزة.

2- **مسابقة المشاهد التمثيلية:** حيث يعدّ الفريق المشارك في المسابقة مشهداً تمثيلاً مصوراً عن طريق الفيديو، ويتضمن موضوعاً تعليمياً أو ثقافياً أو تربوياً أو توعوياً، ويتكلم المشاهدون باللغة العربية الفصحى، ثم يرسل المشاركون مشاركاتهم إلى البريد الإلكتروني الخاص بالجهة المنظمة، وتوضع الشروط والضوابط المقننة للمسابقة، وتوضح جوائزها، وتحدد المواعيد الخاصة بتسليم المشاركات، وتحدد مواعيد التقييم والتكريم للفائزين. وهذه المسابقة تساعد غير الناطقين بالعربية على تعلم العربية والانغماس فيها، واستخدامها في الحياة اليومية أو في المواقف المختلفة، فتتطور لديهم المهارات اللغوية الأربع وتحسّن.

القسم الثاني: مسابقات العلوم العربية:

ويقصد بها المسابقات التي يُستهدف بها الطلبة المتقنون للمهارات اللغوية والذين يدرسون علوم العربية المتقدمة كالنحو والصرف وأصول اللغة وأصواتها، وكذلك علم البلاغة والأدب وغيرها من العلوم اللغوية العربية المتقدمة.

ويقترح في هذا القسم المسابقات الآتية:

1- **مسابقة علمية بحثية:**

وهي مسابقة مخصصة لفئة المتقدمين فقط، ويتم تطبيقها على علوم اللغة العربية كالنحو والصرف والبلاغة والأدب، فتقيم الجامعة هذه المسابقة لقياس مدى استيعاب الطلاب للدروس، وقدرتهم على تطبيق ذلك على النصوص المختلفة، وتحليل المسائل والشواهد المرتبطة بها، وتضع الإدارة المنظمة بالجامعة أو اللجان المتخصصة في المسابقات العلمية الشروط والضوابط المقننة للمسابقة، وما يتعلق بها من المواضيع أو المحاور الرئيسية والفرعية ليتناولها المتعلمون بالبحث والتفصيل والتحليل، مع تحديد مواعيد التسليم، وكذلك الجوائز المرصودة للمتميزين، وتقام هذه المسابقة مرة واحدة في العام، وتوضع ضوابطها وشروطها ويعلن عنها في بداية العام، حتى يأخذ المشاركون الوقت الكافي لإعداد أبحاثهم وأوراقهم العلمية، وترسل الأبحاث إلى الإيميل الإلكتروني، وتشكل لجان علمية لفحص وتحكيم الأبحاث المقدمة، وتقويمها وفرز المتميز منها، ويكون التحكيم على مرحلتين: التحكيم الأولي العلمي النظري، ثم التحكيم النهائي العلني للأبحاث المتميزة في التحكيم الأولي، ويكون التحكيم العلني في فعاليات الأسبوع الثقافي الذي تقيمه الجامعة، وبعد ذلك يُكرم أصحاب الأبحاث الفائزة في الحفل الختامي السنوي.

2- **مسابقة الإلقاء والخطابة:**

وتقام هذه المسابقة كذلك مرة واحدة العام، أو مرتين، ويعلن عنها في بداية العام، ويقترح أن يكون تحكيمها علنياً أمام الحضور والجمهور، في فعاليات الأسبوع الثقافي التي تقيمها الإدارة المنظمة في الجامعة في نهاية العام، وتشكل لجنة مختصة لتحكيم المشاركين المتقدمين للمسابقة، وتكون طريقة المسابقة أن يصعد المشارك إلى منصة التحكيم للإلقاء، ثم تعطيه اللجنة موضوعاً مفاجئاً غير معروف للمتكلم، ولم يُعدّ أو يُحضّر له مسبقاً، ثم يعطى فرصة لمدة 5 دقائق ليُلمّ شتات الموضوع الذي سيتكلم عنه، من غير استعانة

بأي أمر كان سوى ذاكرته، ثم يرتجل متكلماً في الموضوع الذي اختاره، من غير أدوات مساعدة كورقة مكتوبة أو غيرها، وتقوم لجنة التحكيم أداء المشارك، ثم تعلن أسماء الفائزين في الحفل الختامي السنوي للبرامج، ويكرمون باستلام جوائزهم وشهادات التقدير.

3- المسابقة الثقافية اللغوية الكبرى بين الفرق.

وتعقد هذه المسابقة في إحدى مقرات الجامعة المنظمة، قبل الحفل الختامي السنوي، وقبل الأسبوع الثقافي، وبحضرها الراغبون في المشاركة، ويتم الإعلان عن المسابقة على الحسابات المختلفة للجهة المنظمة، وتوضع لها الشروط والضوابط الخاصة بها، وتحدد جوائزها، وتنشر قبل موعد إقامة المسابقة بعدة شهور، ويكون المشاركون فُرُقاً متعددة، بالشروط المحددة لتكوين الفرق، وتوضع فترة لتسجيل الفرق، ثم يتم التنسيق والإعداد لإقامة المسابقة في الموعد المحدد، وتُعدّ الجهة المنظمة بالجامعة واللجان المختصة فيها أسئلة المسابقة، وتكون ضمن المواضيع والمواد التعليمية المنشورة سابقاً على حسابات الجهة المنظمة بالجامعة، في العام المنصرم القريب، وتعقد المسابقة في يومين أو ثلاثة أو أكثر –بحسب عدد الفرق المشاركة–، ويكرم الفريق الفائز في الحفل الختامي السنوي للبرامج، وتعقد هذه المسابقة مرة واحد في العام.

وهذه المسابقة ممكن أن تقام للمبتدئين والمتوسطين والمتقدمين، كل فئة لها مسابقة مستقلة.

القسم الثالث: مسابقات قياس المهارات اللغوية والعلوم العربية.

ويقصد بها المسابقات التي يُستهدف بها طلبة القسمين السابقين جميعاً، مع ضرورة الفصل في المسابقات بين كل قسم بحسب المستوى التعليمي، ويقترح في هذا القسم المسابقات الآتية:

1- مسابقة لغوية تحريرية.

وطريقتها أن توضع مجموعة من الأسئلة التعليمية، تشمل المواضيع والدروس التي تم بثها ونشرها في فترات سابقة، ثم يعقد اختبار إلكتروني للطلاب في يوم محدد على إحدى الحسابات الإلكترونية للجهة المنظمة بالجامعة –كالتليقرام مثلاً، ثم ترسل الإجابات إلى إميل الجهة المنظمة، ويكون وقت الاختبار قصيراً لا يتعدى الساعة ونصف الساعة، وتتضمن أسئلة الاختبار أمثلة تطبيقية على نصوص من القرآن الكريم أو الحديث النبوي الشريف أو الشعر العربي الفصيح، أو الكلام النثري الوارد عن العرب الفصحاء. ويمكن أن تكون هذه المسابقة دورية، تعقد في كل شهر أو شهرين مرة واحدة، وتوضع أسئلتها مما تم بثه من الدروس في الأيام السابقة أو الشهر الماضي قبل الاختبار.

ويمكن كذلك أن تعقد هذه المسابقة بحضور الطلاب إلى قاعة معينة في مدينة محددة، وذلك إذا كان المشتركون في أماكن متقاربة، أو يعمل للمتواجدين في منطقة معينة مسابقة خاصة بهم، وترسل الإجابات إلى البريد الإلكتروني على حساب (G-mail) المرتبط باليوتيوب، ثم تصحح الأسئلة من اللجنة المختصة، أو تكون الأسئلة إلكترونية يتم تنفيذها عن طريق نماذج أو استمارات قوئل، ويكون تنفيذ المسابقة إلكترونياً، بعد توفر الأجهزة الإلكترونية اللازمة لكل متسابق، سواء جهازه الشخصي، أو ما توفره الجهة المنظمة للمسابقة، وتعلن النتائج في الحفل الختامي السنوي، ويكرم الفائزون فيه.

وهذه المسابقة تصلح للفئات كلها: المبتدئين والمتوسطين والمتقدمين. وهي مفيدة للطلبة بحيث تجعل الطالب يراجع دروسه باستمرار، ويقوى تركيزه إذا حضر دروس اللغة العربية، وتزيد مشاركته في القاعة من خلال إجابته على أسئلة المعلم، أو طرحه للأسئلة والإشكالات التي يواجهها، أو يتناقش مع المعلم أو زملائه في المسائل. وهذا كلها تعين الطالب على إتقان ما يتعلمه من الدروس، ويضبط المعلومات فترسخ في ذهنه. وهذا يقال في جميع المسابقات القادمة التي سيتم توضيحها وشرح طريقتها.

2- مسابقة لغوية إلكترونية قصيرة.

وتكون بوضع أسئلة قصيرة وخفيفة للطلاب، عن إحدى المواد التعليمية التي تم بثها قبل المسابقة على الحسابات الرئيسية، وتقام المسابقة على الحسابات المساندة كالتويتير أو السناپ شات، ويمكن إقامتها كذلك أو الإعلان عنها على الفيس بوك، وتكون الإجابات في فترة قصيرة جداً لا تتعدى نصف ساعة من بعد وضع السؤال المنشور مباشرة، ثم يقفل باب المشاركة، ويرسل المشاركون إجاباتهم برسائل خاصة إلى البريد الخاص لحساب الجهة المنظمة بالجامعة على التويتير أو السناپ شات، أي في الموقع الذي أقيمت فيه المسابقة، ويتم إعلام الفائزين على الحسابات نفسها، وترسل جوائزهم عبر حساباتهم البنكية إن كانت مالية، أو ترسل له عبر البريد اليدوي إن كانت مجسمة.

3- المسابقة الثقافية اللغوية الكبرى بين الجامعات

حيث يقترح أن تعد الجهة المنظمة في الجامعة مسابقة ثقافية على مستوى الجامعات، وتكون على مستويين: المستوى الأول: مسابقة ثقافية شرعية لغوية، ويكون المستهدفون ممن أتقن اللغة العربية وعلومها، وكانت دراساتهم مشتملة على الجوانب الشرعية

المستوى الثاني: مسابقة لغوية مهارية، ويكون المستهدفون من الطلبة الناطقين بغير العربية، أو طلبة دول معينة مثلاً طلبة جامعات دول جنوب شرق آسيا.

وتقوم الجهة المنظمة في إحدى الجامعات بالإعداد والتحضير لهذه المسابقة، وتختار فرق العمل، وتضع الشروط والضوابط المقننة للمسابقة، وتختار مجموعة من الأساتذة والمتخصصين للإشراف على الجانب العلمي والثقافي فيه، ويضعون الأسئلة المناسبة لكل مسابقة، وتكون الأسئلة مناسبة لطلبة المستويين المذكورين، وتنشر الإعلانات عنها في جميع حسابات الإلكترونيات المختلفة على وسائل التواصل الاجتماعي، ويقترح أن يكون التنفيذ على إحدى طريقتين:

- 1- إما أن تكون عن طريق حضور جميع الفرق والطلبة المتنافسين إلى مقر الجامعة المنظمة، وتعد المسابقات في القاعات المخصصة لها، مع ضرورة عمل بث مباشر لهذه المسابقة على حسابات وسائل التواصل الاجتماعي كالفيس بوك واليوتيوب.
- 2- أو تقام إلكترونياً عن بعد، بالبث المباشر عن طريق إحدى برامج الاتصال المباشر المرئي والمسموع مثل برنامج: (ZOOM) و (Google Meet) و (Microsoft Teams)، مع وجود بث مباشر على أحد حسابات برامج التواصل الاجتماعي كالفيس بوك واليوتيوب.

ويمكن أن تشارك الجهة المنظمة في الجامعة بعض الجامعات المحلية أو الدولية في التنفيذ، ويكون التنفيذ في مقر الجامعة الرئيسة إن كانت المسابقة حضورياً، أو يكون التنفيذ مشاركة بين الجامعات المنظمة إن كانت المسابقة إلكترونياً عن بعد. ومن التجارب الجيدة في مجال المسابقات الثقافية الإلكترونية ما أقامته مجموعة جامعات في ماليزيا وإندونيسيا وتايلند، بمناسبة الاحتفاء باليوم العالمي للغة العربية لعام 2021، حيث أقامت مسابقة لغوية دولية إلكترونية، وشاركت ثمانية فرق من أربعة جامعات، وأقيمت على برنامج الزووم الإلكتروني (ZOOM)، والجامعات المنظمة والمشاركة في هذه المسابقة هي: جامعة المدينة العالمية بماليزيا، وجامعة الأمير سونكلا فرع فطاني بتايلند، وجامعة أزلان شاه في فيرق، وجامعة الأزهر إندونيسيا دولية مشتركة بين الجامعات المذكورة، حيث شارك معدو هذا البحث في التنظيم والتنفيذ كذلك، وأقيمت المسابقة بتاريخ 20-12-2021، عبر برنامج الزووم وموقع الفيس بوك، ورابط تسجيل المسابقة:

<https://www.facebook.com/mediummalaysia/videos/607878480334203>

المطلب الخامس: إقامة أسبوع ثقافي وحفل ختامي سنوي:

يعقد فريق الجهة المنظمة بالجامعة هذا الحفل السنوي ليكون خاتمة أعمالها وبرامجها لعام كامل، ويتم فيه تكريم الفائزين في المسابقات المختلفة، وكذلك تكريم الجهات الداعمة والراعية والمشاركة في إنجاح البرامج والأنشطة، وتكريم الأعضاء الفاعلين في البرامج والفعاليات.

ويقترح أن يسبق هذا الحفل الختامي مجموعة من البرامج والفعاليات الثقافية، مثل: إقامة تحكيم علني لبعض المسابقات مثل: مسابقة الأبحاث العلمية، ومسابقة الإلقاء والخطابة، ومسابقة أفضل مشهد تمثيلي.

كما يُقترح أن يقيم في هذا الحفل الثقافي معرضاً مصاحباً تعرض فيه صوراً للمنجزات التي تحققت خلال عام كامل للجهة المنظمة وفريق العمل، كما تعرض بعض اللوحات العلمية (البوسترات) المستخرجة والمستخلصة من الأبحاث العلمية المقدمة في مسابقة الأبحاث.

ويقيم هذا الأسبوع الثقافي مع الحفل الختامي في إحدى القاعات الرئيسية للجامعة، وينقل عبر البث المباشر لجميع المشاركين في البرامج التعليمية والأنشطة والمسابقات التابعة لها، ويكون البث عبر أحد الحسابات الرسمية على وسائل التواصل الاجتماعي للجهة المنظمة، مثل الفيس بوك، بالربط مع برنامج (Zoom) أو غيره.

المطلب السادس: دعوة الجهات والمؤسسات التعليمية والتربوية والتجارية لتبني البرامج ودعمها.

لاشك أن هذه البرامج تحتاج إلى ميزانيات ضخمة؛ لتمويل تصميم البرامج وتأمين الأجهزة والمعدات اللازمة للتعليم، وتجهيز المقرات، وتصميم البرامج والمواقع وإدارتها، وتأمين مكافآت ورواتب فرق العمل، وكذلك يحتاج إلى دعم الجهات أو المراكز العلمية المتخصصة للمشاركة في تنفيذ البرامج، وكذلك الإشراف على سير العمل وتنفيذ البرامج على مراحلها المختلفة.

ولهذا تقترح الدراسة أن يتولى هذه البرامج والفعاليات الجامعات العلمية الحكومية أو الخاصة، ممثلة في كلياتها أو مراكزها العلمية المتخصصة، فتشرف عليها، وتتابع سيرها، ويستحسن أن تكون جامعة علمية من الجامعات المرموقة الكبيرة، المتخصصة في مجال اللغة العربية، ولديهم كوادر علمية وإدارية ذات خبرة وكفاءة، سواء في ماليزيا، مثل: جامعة مالايا، أو الجامعة الإسلامية العالمية الماليزية أو الجامعة الوطنية الماليزية، أو جامعة العلوم الإسلامية أو غيرها من جامعات ماليزيا الكبيرة والمتخصصة في اللغة العربية، ويمكن كذلك أن تنفذها بعض الجامعات الكبيرة في الدول العربية، وأهمها المملكة العربية السعودية، مثل: جامعة أم القرى بمكة، أو الجامعة الإسلامية بالمدينة، أو جامعة الملك سعود بالرياض، أو جامعة الملك عبدالعزيز بجدة، أو جامعة الإمام محمد بن سعود بالرياض، لما لهذه الدولة من ميزة تعلق المسلمين بما فيهما من الحرمين الشريفين وأماكن العبادة، ولما كانت عليه الجزيرة العربية سابقاً من وجود القبائل العربية الفصيحة التي أخذت عنها اللغة العربية وجمعت، وما زالت بعض القبائل متمسكة باللهجات العربية القديمة فيها، كما هو ملاحظ في بعض قبائل نجد ووسط الجزيرة العربية.

ويكون هذا الدعم والتعاون من قبل هذه الشركات والمؤسسات ورجال الأعمال من قبيل المشاركة المجتمعية لتعليم المجتمعات اللغة العربية، والتي أصبحت إحدى متطلبات الحياة العلمية والعملية في الكثير من الدول في العالم، سواء كانت حاجتها في ذلك دينية أو علمية أو ثقافية أو اجتماعية أو اقتصادية أو غير ذلك.

المراجع والمصادر

المراجع العربية:

البخيت، خالد حامد فاضل، كناكر، وأسامة، (2021)، أثر استخدام وسائل الإعلام الجديدة في جامعة ظفار، للباحثين: وهو بحث منشور في مجلة الاتصال والإعلام الإسلامي المعاصر، في جامعة العلوم الإسلامية بماليزيا، المجلد (1)، العدد (2)،

ورابط البحث : <https://jicicom.usim.edu.my/index.php/journal/article/view/18>

التودري، عوض، (2005)، المدرسة الإلكترونية وأدوار حديثة للمتعلم، الرياض، مكتبة الرشد
التويجري، عبدالعزيز بن عثمان (2004)، لغة الإعلام وآثارها في تحقيق التنمية اللغوية، منشورات المنظمة الإسلامية للتربية والعلوم والثقافة، إيسيسكو، الرباط، المغرب .

التويجري، عبدالعزيز بن عثمان، (2004)، مستقبل اللغة العربية، منشورات المنظمة الإسلامية للتربية والعلوم والثقافة، إيسيسكو، الرباط، المغرب، الطبعة الأولى

جامعة الملك سعود، معهد اللغة العربية، (2009)، التوصيات المنبثقة عن المؤتمر العالمي لتعليم اللغة العربية لغير الناطقين بها حسان، تمام، (2004)، لغة الإعلام، مجلة مجمع اللغة العربية، بحوث مؤتمر الدورة الرابعة والخمسين، مصر، الجزء (68) مايو (1988)

الحيلة، محمد، (2007)، تكنولوجيا التعليم بين النظرية والتطبيق، عمان، دار المسيرة
الخولي، أمين، (1987)، مشكلات حياتنا اللغوية، الهيئة المصرية العامة للكتاب، القاهرة، مصر
الزامل، غالب عبدالعزيز، (2012)، اللغة العربية والتعليم العالي، مقال منشور على الإنترنت، بتاريخ : 2012/5/7 تاريخ الاطلاع: 2022-7-7، ورابط النشر:

<https://www.alukah.net/culture/0/40750/%D8%A7%D9%84%D9%84%D8%BA%D8%A9-%D8%A7%D9%84%D8%B9%D8%B1%D8%A8%D9%8A%D8%A9-%D9%88%D8%A7%D9%84%D8%AA%D8%B9%D9%84%D9%8A%D9%85-%D8%A7%D9%84%D8%B9%D8%A7%D9%84%D9%8A/>

السبعان، لليلي خلف، (2001)، ظواهر صرفية معاصرة في وسائل الإعلام الخليجية، مجلة كلية الآداب، بجامعة المنصورة، مصر، العدد (28) يناير

عواج، سامية، وسامية، تيزي، (2016)، دور مواقع التواصل الاجتماعي في دعم التعليم عن بعد لدى الطلبة الجامعيين، من كلية الإعلام والاتصال، بجامعة سطيف الجزائر، وقدم في المؤتمر الدولي الحادي عشر لمركز جيل البحث العلمي حول التعلم بعصر التكنولوجيا الرقمية والذي نظمه الاتحاد العالمي للمؤسسات العلمية بالتعاون مع جامعة تيبازة في طرابلس لبنان أيام 22 و23 و24 أبريل 2016، ورابط البحث: <http://jilrc.com/archives/5005>

العيسائي، عبدالمجيد، (2010)، الاكتساب اللغوي والإعلام، مجلة الأثر، ومجلة الآداب واللغات، جامعة قاصدي مرباح، ورقلة، الجزائر، العدد (9) مايو (2010).

قميحة، جابر (1998)، أثر وسائل الإعلام المسموعة والمرئية والمقروءة في اللغة العربية، الناشر: نادي المدينة المنورة الأدبي - المدينة المنورة

الكخن، أمين، وهنية، لينا، (2009)، أثر استخدام الدراما التعليمية في تدريس قواعد اللغة العربية في تحصيل طالبات الصف العاشر الأساسي، المجلة الأردنية في العلوم التربوية، مجلد (5)، العدد (3)

لافي، سعيد عبدالله، (2006)، التكامل بين التقنية واللغة، القاهرة، عالم الكتب.
مجيد، سيروان أنور، (2009)، سلطة الكلمة في الفضاء الإعلامي المعاصر؛ دراسة لغوية تحليلية، مجلة الدراسات اللغوية والأدبية،
الصادرة من الجامعة الإسلامية العالمية، كوالالمبور، ماليزيا، السنة الأولى، العدد (1)
مدني، أسامة بن غازي، (2019)، استخدام الطلبة الجامعيين لمواقع التواصل الاجتماعي، الأستاذ في قسم الإعلام، بكلية العلوم
الاجتماعية، بجامعة أم القرى بمكة، ورابط البحث:
https://fjhj.journals.ekb.eg/article_93452_254978959fe961b4530fc4f09c07bd61.pdf
المقالح، عبدالعزيز، الجامعات العربية ودورها في تعليم اللغة العربية، مقال منشور على الإنترنت، تاريخ الاطلاع: 07-07-
2022، ورابط النشر:

<https://www.hamassa.com/2017/06/23/%D8%A7%D9%84%D8%AC%D8%A7%D9%85%D8%B9%D8%A7%D8%AA-%D8%A7%D9%84%D8%B9%D8%B1%D8%A8%D9%8A%D8%A9-%D9%88%D8%AF%D9%88%D8%B1%D9%87%D8%A7-%D9%81%D9%8A-%D8%AA%D8%B9%D9%84%D9%8A%D9%85-%D8%A7%D9%84%D9%84%D8%BA/#:~:text=%D8%AC%D8%A7%D9%85%D8%B9%D8%A9%20%D8%B5%D9%86%D8%B9%D8%A7%D8%A1%20%D9%88%D8%A7%D9%84%D9%84%D8%BA%D8%A9%20%D8%A7%D9%84%D8%B9%D8%B1%D8%A8%D9%8A%D8%A9%20%3A,%D9%88%D8%A7%D9%84%D8%A3%D9%87%D9%85%20%D9%81%D9%8A%20%D8%A3%D8%AF%D8%A7%D8%A6%D9%87%D8%A7%20%D9%84%D9%87%D8%B0%D9%87%20%D8%A7%D9%84%D8%B1%D8%B3%D8%A7%D9%84%D8%A9%20.>

هندي، عزيز رشيد، وسائل التواصل الاجتماعي وأثرها على الفرد والمجتمع، بحث منشور على الإنترنت، تاريخ الاطلاع: 26-7-
2022، ورابط النشر:

https://www.academia.edu/29616133/%D9%88%D8%B3%D8%A7%D8%A6%D9%84_%D8%A7%D9%84%D8%AA%D9%88%D8%A7%D8%B5%D9%84_%D8%A7%D9%84%D8%A7%D8%AC%D8%AA%D9%85%D8%A7%D8%B9%D9%8A_%D9%88%D8%A3%D8%AB%D8%B1%D9%87%D8%A7_%D8%B9%D9%84%D9%89_%D8%A7%D9%84%D9%81%D8%B1%D8%AF_%D9%88%D8%A7%D9%84%D9%85%D8%AC%D8%AA%D9%85%D8%B9_pdf

هيام حايك، (2019)، أهم 5 فوائد لاستخدام وسائل الإعلام الاجتماعي في المؤسسات التعليمية، مقالة منشورة على الانترنت،
وتم الاطلاع عليها بتاريخ: 8-7-2022، ورابط النشر:

<https://blog.naseej.com/%D8%A3%D9%87%D9%85-5-%D9%81%D9%88%D8%A7%D8%A6%D8%AF-%D9%84%D8%A7%D8%B3%D8%AA%D8%AE%D8%AF%D8%A7%D9%85-%D9%88%D8%B3%D8%A7%D8%A6%D9%84-%D8%A7%D9%84%D8%A5%D8%B9%D9%84%D8%A7%D9%85-%D8%A7%D9%84%D8%A7%D8%AC%D8%AA%D9%85%D8%A7%D8%B9%D9%8A-%D9%81%D9%8A-%D8%A7%D9%84%D9%85%D8%A4%D8%B3%D8%B3%D8%A7%D8%AA-%D8%A7%D9%84%D8%AA%D8%B9%D9%84%D9%8A%D9%85%D9%8A%D8%A9>

مواقع لأبحاث علمية تخص استخدام مواقع التواصل الاجتماعي في التعليم:

<https://www.jawad-book.com/2022/04/master-social-media.html>
<https://mothakirat-takharoj.com/%D8%B1%D8%B3%D8%A7%D8%A6%D9%84-%D9%85%D8%A7%D8%AC%D8%B3%D8%AA%D9%8A%D8%B1->

[%D8%B9%D9%86-%D8%B4%D8%A8%D9%83%D8%A7%D8%AA-%D8%A7%D9%84%D8%AA%D9%88%D8%A7%D8%B5%D9%84-%D8%A7%D9%84%D8%A7%D8%AC%D8%AA%D9%85/](#)

المراجع الأجنبية :

Teeter. T. (1997) teaching on the internet meeting the challenge of electronic learning ERIC NO. ED418957.

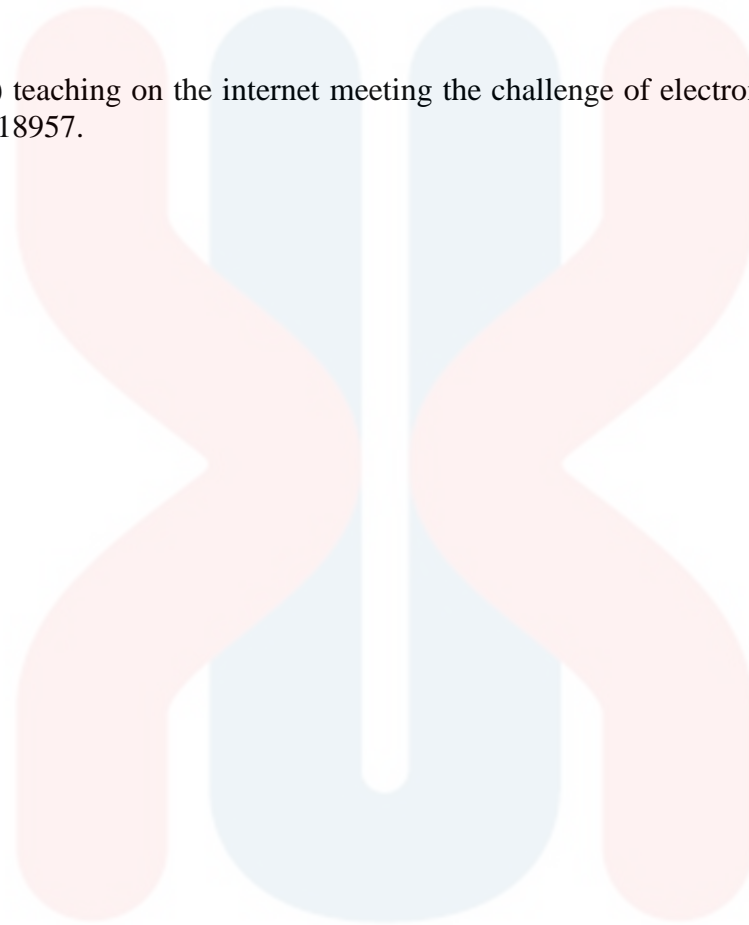

UNIVERSITI

MALAYSIA

KELANTAN

**Pelaksanaan Kem Bestari Solat dalam Kalangan Guru Pendidikan Islam
Sekolah Murid Orang Asli**
*Implementation of 'Kem Bestari Solat' Among Islamic Education Teachers of
Indigenous Students School*

Mohamad Zahier Zamahshari
Fakulti Pendidikan, Universiti Kebangsaan Malaysia
p111220@siswa.ukm.edu.my

Mohd Isa Hamzah
Fakulti Pendidikan, Universiti Kebangsaan Malaysia
isa_hamzah@ukm.edu.my

ABSTRACT

Strengthen Islamic Education efforts in the country can be prove by the existence of the j-QAF program. One of the components of the j-QAF program is the Kem Bestari Solat (KBS) which aims to strengthen Islamic Education and ensure that primary school students can fulfill their prayer obligations as well as possible. In discussing the issue of the implementation of KBS in urban and rural schools, the MOE did not ignore the rural schools and the limitation faced by the teachers who serve in these schools. Thus, the researcher has made a literature review on the implementation of KBS by Islamic Education Teachers in Indigenous people schools around Perak. The results of this finding is hoped to be used as a meaningful knowledge for educators to improve the implementation of the Kem Bestari Solat in an effort to improve the prayer among Muslim students in addition to dignify the subject of Islamic Education in general and Islam itself in particular.

Keywords: Kem Bestari Solat, Islamic Education Teachers, Indigenous School.

ABSTRAK

Dalam konteks pendidikan di Malaysia, usaha bagi memantapkan lagi Pendidikan Islam di negara ini dapat dibuktikan dengan wujudnya program j-QAF. Salah satu komponen program j-QAF adalah Kem Bestari Solat (KBS) yang bertujuan untuk memperkasakan Pendidikan Islam seterusnya memastikan murid sekolah rendah dapat menunaikan kewajipan solat dengan sebaik mungkin. Dalam membincangkan isu pelaksanaan KBS di sekolah bandar dan luar bandar, KPM tidak mengabaikan sekolah-sekolah pedalaman serta kekangan yang dihadapi oleh para guru yang berkhidmat di sekolah-sekolah tersebut. Justeru, pengkaji telah membuat satu kajian kepustakaan untuk melihat aspek yang mempengaruhi kesediaan serta cabaran yang perlu dihadapi oleh Guru Pendidikan Islam yang melaksanakan KBS di sekolah murid orang asli. Diharapkan hasil daripada dapatan ini akan dijadikan sebagai perkongsian bersama kepada golongan pendidik untuk penambahbaikan dalam pelaksanaan Kem Bestari Solat dalam usaha menyempurnakan lagi perlakuan solat dalam kalangan pelajar muslim disamping memartabatkan lagi matapelajaran Pendidikan Islam umumnya dan agama Islam itu sendiri khususnya.

Kata Kunci: Kem Bestari Solat; Guru Pendidikan Islam; Sekolah murid orang asli

Pengenalan

Ibadah merupakan perkara utama dan sangat penting dalam proses pembentukan hubungan antara hamba dengan penciptanya. Satu daripada lima rukun Islam yang wajib ditunaikan oleh seluruh umat Islam yang cukup syaratnya adalah ibadah solat fardhu 5 waktu setiap hari (Siti Zaleha et al, 2016; Sharifah Nur, 2012). Solat adalah ibadah tunjang yang menjadi kaedah paling dekat untuk berhubung dengan Allah s.w.t sekaligus dapat mendekatkan diri seseorang

hamba dengan yang Maha Esa yang perlu dilakukan mengikut ketetapan dan waktu yang telah disyariatkan oleh Allah s.w.t. (Nor Azah, 2011).

Sistem Pendidikan Islam di Malaysia mengalami banyak perubahan selari perkembangan dunia pendidikan hari ini. Perubahan ini juga penting bagi memastikan proses penyampaian Pendidikan Islam dapat dipertingkatkan. Justeru, kurikulum Pendidikan Islam dibahagikan kepada beberapa bidang utama iaitu al-Quran, Jawi, Akidah, Ibadah, Sirah dan Adab. Salah satu topik utama yang terkandung dalam bidang ibadah ialah solat. Pengajaran dan pembelajaran (PdP) bagi solat ini lazimnya dijalankan secara teori dan amali mengikut kesesuaian. Penguasaan murid dalam solat seharusnya diberi perhatian yang serius bagi memastikan kewajipan ini tidak diabaikan. Hal ini demikian kerana kewajipan solat merupakan tanggungjawab utama bagi setiap individu muslim yang terdapat di dalam rukun Islam.

Usaha bagi memantapkan lagi Pendidikan Islam di negara ini dapat dibuktikan dengan wujudnya program j-QAF yang merupakan hasil idea daripada mantan Perdana Menteri, Tun Abdullah Ahmad Badawi (KPM, 2004). Tujuan utama program ini diwujudkan adalah untuk memperkasakan Pendidikan Islam seterusnya memastikan murid sekolah rendah dapat membaca al-Quran dengan baik, menguasai Bahasa Arab, mengamalkan asas-asas fardhu ain serta menguasai jawi dengan baik. Pelaksanaan program j-QAF ini telah pun bermula sejak 2005 dan telah melalui pelbagai proses penambahbaikan bagi memastikan setiap murid memperoleh manfaat daripadanya untuk diamalkan dalam kehidupan seharian. Sepanjang pelaksanaan program j-QAF ini juga, aspek kekuatan dan kelemahannya telah dikenal pasti oleh para penyelidik menerusi kajian-kajian yang telah dijalankan.

Rentetan terdapat masalah yang timbul ketika pelaksanaan amalan solat dalam kalangan murid menerusi pelaksanaan Projek Rintis pada April 2004, pihak KPM telah memperkenalkan Model Kem Bestari Solat (KBS). Pelaksanaan Model KBS ini telah bermula pada tahun 2005 secara berperingkat di sekolah rendah sebagai salah satu usaha memperkasakan Pendidikan Islam (Siti Fatimah & Abdul Halim, 2010). KBS dijalankan di luar sesi pengajaran dan pemudahcaraan (pdpc). Kaedah pelaksanaan aktiviti ini adalah secara bersiri iaitu sebanyak 4 kali setahun. Sewaktu pelaksanaan kem ini, murid-murid dibimbing sepenuhnya agar dapat menguasai rukun-rukun yang terdapat dalam solat. Guru yang bertindak sebagai fasilitator juga berperanan dalam mengupayakan murid-murid bagi memastikan ibadah solat murid-murid dapat dipertingkatkan.

KBS juga dijalankan bertujuan memperkukuhkan lagi penguasaan murid dalam ibadat solat dan berwuduk. Melalui KBS, murid akan dinilai kemampuan mereka melalui penguasaan dua perkara tersebut. Aktiviti kokurikulum yang lebih berbentuk amali ini diharapkan dapat menarik minat murid untuk mengikuti dan mempelajari ibadah solat dan diharapkan amalan solat menjadi sehati dalam diri mereka. Kesungguhan pihak KPM dalam memastikan keberkesanan Pendidikan Islam khususnya aspek amali solat amat jelas dengan terlaksananya PAFA pada tahun 1995 (Suhaimi, 2007). Dalam pelaksanaan PAFA semua murid beragama Islam akan diuji secara amali sepanjang persekolahan iaitu di peringkat Penilaian Menengah Rendah (PMR) dan Sijil Peperiksaan Malaysia (SPM).

Secara umumnya, pembangunan rohani murid dapat dipupuk melalui pelaksanaan model pengajaran j-QAF seterusnya memberi kesan positif (Ibrahim et al., 2009). Usaha ini dilihat sebagai satu titik permulaan yang berkesan untuk membentuk jati diri kanak-kanak yang beragama Islam. Matlamat utama program KBS antaranya adalah untuk meningkatkan kemahiran, kesungguhan dan rasa tanggungjawab untuk melaksanakan aspek fardhu ain dalam

kehidupan seharian bagi individu beragama Islam. Kem Bestari Solat merupakan aktiviti yang dilaksanakan bagi memastikan murid dapat menunaikan solat dengan sempurna dari segi bacaan dan perbuatan. Aktiviti ini dilaksanakan secara intensif di satu tempat khusus mengikut kesesuaian sesebuah sekolah.

PERNYATAAN MASALAH

Masalah yang menjadi punca utama akses pendidikan di sekolah murid orang asli ini adalah berkenaan lokasi dan perhubungan. Perjalanan ke sekolah menggunakan pelbagai jenis kenderaan di dunia termasuk terpaksa berjalan kaki untuk sampai ke sekolah yang di kelilingi hutan tebal memerlukan kesediaan mental dan fizikal yang tinggi oleh guru (Abas & Saemah, 2017). Hakikat ini merupakan situasi sebenar yang terpaksa dilalui oleh golongan pendidik di kawasan sekolah murid orang asli sekaligus menjadi cabaran dalam memenuhi aktiviti kurikulum murid orang asli terutamanya di luar waktu sekolah. Hal ini kerana tiada peruntukan waktu khusus bagi pelaksanaan KBS di dalam waktu persekolahan menyebabkan ianya perlu dilakukan diluar waktu persekolahan sekaligus mengundang isu-isu lain di sekolah pedalaman ini.

EKMLTK yang membawa frasa Elaun Kesusahan Mengikut Lokasi dan Tahap Kesusahan itu sendiri sudah jelas menggambarkan kesukaran yang terpaksa dihadapi oleh guru-guru pedalaman dalam menyampaikan ilmu kepada murid orang asli ini (Mohamad Zahier & Zamri, 2021). EKMLTK yang ditetapkan oleh KPM mengambil kira kriteria-kriteria seperti bilangan mod pengangkutan, risiko perjalanan, sumber air, sumber elektrik, telekomunikasi dan lain-lain (KPM, 2014).

Oleh itu, kajian ini turut memperlihatkan kesediaan guru-guru pedalaman dalam melaksanakan KBS diluar waktu persekolahan walaupun terpaksa berdepan dengan cabaran jarak perjalanan yang jauh serta bentuk geografi laluan hingga ke dalam hutan tebal untuk tiba ke sekolah serta kampung-kampung dan rumah murid-murid untuk mencari mereka. Seperti yang dilaporkan Utusan Borneo (2020), berkenaan kisah Cikgu Nazmi, seorang guru Bahasa Inggeris yang menempuh perjalanan sejauh hampir 200 kilometer seminggu sekali yang memakan masa selama dua hari perjalanan semata-mata untuk menghantar bahan pembelajaran kepada 111 muridnya di 13 kampung pedalaman di Lawas, Sarawak disebabkan oleh kekurangan prasarana pendidikan, serta kekangan capaian internet untuk mengikuti PdPR sebagaimana kemudahan murid-murid di bandar (Mastura, 2020). Sebarang perbezaan dan diskriminasi ini tidak harus wujud di mana-mana peringkat masyarakat dari segi peluang dan mutu dalam pelaksanaan sistem pendidikan negara (Zamri, Jamalul lail & Anita, 2019).

Selain itu, guru-guru ini menghadapi kesukaran menyampaikan maklumat berkenaan pelaksanaan KBS kepada ibu bapa murid-murid supaya menghantar anak mereka ke sekolah disebabkan faktor komunikasi yang terbatas. Perkara ini dikukuhkan lagi hasil temubual kajian yang dilakukan oleh Abas dan Saemah (2017), masalah pengajaran dan pembelajaran merupakan masalah utama yang dihadapi oleh guru-guru novis di pedalaman Sarawak disebabkan oleh kemudahan yang terlalu terhad dan terbatas. Kebanyakan sekolah di kawasan pedalaman mempunyai bahan bantu mengajar yang terhad serta majoritinya tidak mempunyai kemudahan alat pencetak yang menyebabkan proses pengajaran guru turut menjadi terbatas. Masalah ini merupakan masalah umum di hampir kesemua sekolah pedalaman termasuk di semenanjung Malaysia oleh kerana jarak perjalanan serta perhubungan yang terbatas. Oleh itu, guru-guru perlu menyediakan bahan-bahan bantu mengajar seperti bahan bercetak dengan

lengkap terlebih dahulu sebagai persediaan sebelum memasuki kawasan sekolah masing-masing.

Tidak dinafikan ibu bapa juga memainkan peranan yang sangat penting untuk menjayakan pendidikan untuk semua dengan bersikap lebih bertanggungjawab untuk memastikan anak-anak mereka mendapat pendidikan yang sewajarnya (Zamri, Jamalul lail & Anita, 2019). Namun apabila kurangnya bimbingan dari ibu bapa yang majoritinya buta huruf menjadikan bebanan guru semakin bertambah. Malah, guru di pedalaman juga perlu berperang dengan persepsi segelintir ibu bapa yang tidak kisah mengenai pelajaran anak-anak mereka (Nora, 2021). Kerjasama dari pihak ibu bapa adalah amat penting terutamanya untuk menjayakan PdP diluar waktu persekolahan.

Peluang untuk menikmati pendidikan bagi penduduk luar bandar dan pedalaman amat terhad, malahan mengalami pelbagai kekurangan dari segi infrastruktur dan peralatan, kemudahan asas, guru serta sokongan ibu bapa dan masyarakat (Zamri, Jamalul lail & Anita, 2019). Menurut Nora (2021) dalam temubualnya bersama Dr. Anuar Ahmad, “keadaan sekolah luar bandar dan pedalaman khususnya sekolah yang tidak mempunyai prasarana asas sememangnya masih jauh ketinggalan ke belakang, malah ada yang masih tiada kemudahan elektrik dan air bersih. Oleh itu, bagaimana proses PdP dapat dibincangkan dengan baik sekiranya sekolah luar bandar dan pedalaman masih lagi mengemis untuk mendapatkan akses internet dan kemudahan peranti pembelajaran?” Perkara ini menjadi bukti ketidakupayaan serta limitasi sekolah pedalaman dalam melaksanakan proses PdP khususnya KBS oleh kerana fasiliti yang tidak mencukupi dan tidak sesuai untuk melaksanakannya.

Berdasarkan data temubual dengan Penolong Pegawai PPD Kuala Selangor berkenaan program j-QAF, kurangnya persediaan dan kefahaman yang mendalam tentang pelaksanaan sebenar Kem Bestari Solat dalam sebahagian kalangan guru j-QAF sendiri menyebabkan objektif program tersebut tidak dapat dicapai sepenuhnya (Noor Azimah, 2012). Selain itu, masih terdapat segelintir golongan pentadbir yang masih kurang jelas berkenaan pelaksanaan program j-QAF itu sendiri disamping aspek pengurusan yang lemah di beberapa buah sekolah di daerah Kuala Selangor juga menyebabkan program KBS tidak dilaksanakan mengikut bilangan yang ditetapkan iaitu empat kali setahun.

Dalam membincangkan isu pelaksanaan KBS di sekolah bandar dan luar bandar, KPM tidak mengabaikan sekolah-sekolah pedalaman serta kekangan yang dihadapi oleh para guru yang berkhidmat di sekolah-sekolah tersebut. Walau bagaimanapun, tidak terdapat banyak kajian yang memfokuskan kepada pendidikan kawasan pedalaman di Malaysia (Ardi, Bambang & Nora, 2012). Kajian yang dijalankan oleh Norma, Khadijah dan Mohd Aderi (2016) bertajuk Pelaksanaan Kem Bestari Solat (KBS) di sekolah rendah daerah Sepang, Selangor turut mengkaji tahap kesediaan guru Pendidikan Islam dan j-QAF serta keberkesanan pelaksanaannya namun hanya terbatas kepada GPI dikawasan bandar sahaja. Menurut Crispina, Magret dan Lawrence (2018), kajian berkaitan pendidikan rendah dan menengah yang memfokuskan kepada kawasan pedalaman adalah relevan. Hal yang demikian ini penting bagi melihat isu dan konflik yang berlaku sekali gus membangunkan strategi untuk mengurangkan jurang pendidikan yang ada.

Secara jelas, komuniti pendidik akan lebih mendapat manfaat sekiranya terdapat lebih banyak kajian yang berkualiti tinggi dilaksanakan (Cheung & Wong, 2014). Justeru, kajian berkenaan pelaksanaan KBS oleh guru pendidikan Islam di sekolah murid orang asli adalah wajar untuk dilaksanakan untuk melihat tahap kesediaan serta tahap cabaran yang dihadapi

oleh GPI yang sememangnya mempunyai cabaran yang berlainan dari GPI di kawasan bandar. Bertepatan dengan sistem pendidikan negara yang bersifat menyeluruh tanpa mengira sempadan dan batasan geografi.

KEPENTINGAN KAJIAN

Kajian ini membawa kepentingan kepada hala tuju pendidikan murid Orang Asli yang memerlukan elemen pengajaran yang lebih dekat dengan jiwa, keperluan serta menepati minat mereka di sekolah agar dapat melalui pembelajaran dengan lebih bermakna. Kajian ini juga memainkan peranan yang sangat penting dalam meyakinkan guru-guru yang mengajar di SMOA khususnya guru Pendidikan Islam bahawa kesediaan dan ilmu berkenaan pelaksanaan KBS di sekolah perlu dikuasai sebagai mungkin dalam usaha meningkatkan penguasaan ibadah solat murid. Kajian melibatkan cabaran pelaksanaan KBS di sekolah murid Orang Asli juga dapat membuktikan kepada Kementerian Pendidikan Malaysia (KPM), Jabatan Pendidikan Negeri (JPN), Pejabat Pendidikan Daerah (PPD) dan pihak sekolah bahawa semua pihak perlu lebih cakna mengenai cabaran melaksanakan program yang dibangunkan ini untuk mengukuhkan kurikulum serta pendidikan Islam di SMOA amnya.

Keseluruhan kajian ini akan memberi sumbangan yang besar kepada perkembangan dan percambahan ilmu melibatkan murid Orang Asli di samping memperbaharui strategi pengajaran guru di SMOA yang sentiasa berperang dengan kemudahan prasarana yang tidak lengkap dan mencukupi. Secara tidak langsung, kajian ini juga akan menjadi panduan kepada KPM dalam memastikan pelaksanaan kurikulum yang dilaksanakan ini terus diperhebatkan agar lebih relevan, berfokus dan berimpak tinggi. Kajian ini merupakan satu usaha ke arah meningkatkan kualiti pendidikan dalam kalangan murid orang asli khususnya berkaitan ibadah solat.

OBJEKTIF KAJIAN

Kajian ini dijalankan bertujuan untuk melihat sejauh mana pelaksanaan Kem Bestari Solat dalam kalangan Guru Pendidikan Islam di sekolah murid Orang Asli. Secara khususnya kajian ini dijalankan untuk mencapai objektif berikut:

1. Menganalisis aspek kesediaan Guru Pendidikan Islam dalam melaksanakan Kem Bestari Solat di sekolah murid Orang Asli.

METODOLOGI KAJIAN

Kajian yang dijalankan ini menggunakan kaedah penyelidikan kepustakaan yang bertujuan untuk mendapatkan data dan dapatan kajian. Pengkaji telah mendapatkan maklumat melalui pembacaan buku, artikel, tesis dan prosiding. Disamping itu, pengkaji juga telah mencari jurnal-jurnal dalam talian yang boleh didapati dengan melayari enjin carian utama seperti *Google Scholar*, *ResearchGate*, *UKM Institutional Repository* dan *Jurnal Dunia Pendidikan*. Kata kunci yang digunakan dalam mencari maklumat adalah “Kem Bestari Solat”, “kesediaan”, “cabaran”, “sekolah pedalaman”. “sekolah murid orang asli”, “program J-QAF” dan akhir sekali “Pendidikan solat”. Semua maklumat yang diperolehi akan dinilai terlebih dahulu dari sudut kesesuaian dan keaslian kajian sebelum digunakan oleh pengkaji untuk penulisan dalam artikel ini. Seterusnya, bahan dan sumber ini akan dijadikan sumber rujukan utama dalam penghasilan penulisan ilmiah yang bermutu dan mengikut piawaian standard yang telah ditetapkan dalam penulisan akademik.

TINJAUAN LITERATUR

Solat yang diumpamakan sebagai tiang agama merupakan ibadah yang paling dititikberatkan seawal usia 7 tahun lagi. Jika anak-anak masih ingkar dan meninggalkan solat dengan sengaja pada usia 10 tahun, ibu bapa diberikan hak untuk memukul anak mereka dengan tujuan untuk mendidik supaya istiqamah mendirikan solat (Ruhaida & Nurul Ilyana, 2018). Sehubungan dengan itu, didikan solat ini sebenarnya telah bermula diperingkat awal usia kanak-kanak dengan panduan serta didikan ibu bapa dan diteruskan oleh para pendidik di sekolah agar terus istiqamah melaksanakan ibadah solat. Menurut Ruhaida dan Nurul Ilyana (2018), guru merupakan individu penting dalam menyambung tugas mendidik anak-anak khususnya dalam ilmu berkaitan keagamaan dan syariat Islam.

Anak-anak perlu dibimbing dan dilatih untuk menunaikan solat dengan sempurna sejak dari kecil lagi kerana ianya merupakan modul latihan berterusan yang paling berkesan dalam membina dan membentuk kekuatan jiwa, rohani, mental dan iman para pelajar (Norhayati, Khadijah & Mohd Aderi, 2016). Sememangnya dalam memastikan para pelajar sentiasa istiqamah menunaikan solat lima waktu sehari semalam dengan sempurna bukanlah sesuatu perkara yang mudah (Muhammad Fathi & Ros Izanuri, 2013). Terdapat banyak dapatan kajian lepas yang menunjukkan bahawa ramai dalam kalangan pelajar muslim di Malaysia meninggalkan solat atas pelbagai alasan.

Kajian-kajian lepas mendapati bahawa penghayatan solat dalam kalangan remaja masih terlalu rendah serta kewajipan untuk melaksanakan solat dianggap bukanlah suatu keutamaan dalam kalangan remaja (Sharifah Nur, 2012; Shukri Ahmad et al., 2014). Terdapat pelbagai faktor berlakunya isu ini sehingga terhakis rasa tanggungjawab untuk menunaikan kewajipan solat. Antara sebab berlakunya pengabaian solat ini adalah kerana kurangnya ilmu pengetahuan atau kefahaman yang mendalam berkenaan ibadah solat, tiada kesedaran serta motivasi untuk menunaikannya sekaligus menghakis rasa tanggungjawab untuk melaksanakannya. Namun apa yang lebih mendukacitakan, terdapat segelintir pelajar yang mempunyai pengetahuan yang tinggi tentang solat, namun masih tidak melaksanakannya dengan konsisten (Hasna, Ahmad Syukran & Mohd Ismail, 2015).

Berdasarkan kajian yang dilakukan oleh seorang pakar motivasi, Datuk Dr. Mohd Fadzillah Kamsah bersama pensyarah di Universiti Kebangsaan Malaysia, hanya sekitar 23% daripada umat Islam di negara ini yang mendirikan solat 5 waktu menjadikan hampir 80% umat Islam di Malaysia tidak solat dengan lengkap 5 waktu sehari semalam. Trend serta peratusan ini tidak banyak berubah sejak daripada tahun 90-an hingga sekarang (Abd. Halim, 2020). Selain itu, menurut Ketua Penolong Pengarah Kanan, Sektor Pendidikan Islam (SPI), Jabatan Pendidikan Melaka, Ahmad Hamizi Abu Hassan, lebih dari 700 orang murid atau tujuh peratus daripada kira-kira 11,000 orang murid Tahun Enam di Melaka tidak boleh membaca al-Quran, disamping tidak mendirikan solat (Hassan, 2019).

Antara solusi yang dapat dilaksanakan bagi mengatasi masalah kian membimbangkan ini adalah menerusi peranan yang dimainkan oleh guru-guru di sekolah. Pihak sekolah perlu sentiasa menggalakkan murid untuk solat berjemaah di sekolah, mengingatkan mereka supaya tidak meninggalkan solat dirumah, menganjurkan kursus serta kem solat dan kesedaran berkenaan kepentingan solat dan lain-lain lagi (Muhammad Faizal et al., 2017). Dapat dirumuskan bahawa faktor guru serta pihak sekolah sememangnya merupakan solusi utama serta memainkan peranan yang penting dalam proses mendidik remaja dalam melaksanakan rukun Islam yang kedua ini (Suhaila et al., 2018). Hal ini demikian kerana tidak semua ibu

bapa menekankan kepentingan solat ketika mereka berada dirumah menyebabkan remaja semakin hilang arah dan dan mengabaikan solat. Oleh itu, inisiatif yang diambil oleh pihak sekolah dengan melaksanakan program-program berkenaan solat umumnya dan pelaksanaan Kem Bestari Solat khususnya pasti dapat meningkatkan kesedaran dalam kalangan murid.

DAPATAN DAN PERBINCANGAN

Aspek kesediaan Guru Pendidikan Islam dalam melaksanakan Kem Bestari Solat di sekolah murid Orang Asli.

Kerelaan, keinginan dan sesuatu yang telah wujud merupakan takrifan awal yang diberikan kepada kesediaan (Baharom, 2010). Dalam erti kata lain, kesediaan juga bermaksud keupayaan diri individu dalam memulakan sesuatu aktiviti pengajaran (Mook, 2002). Konsep kesediaan yang perlu dimiliki oleh seorang guru merangkumi ilmu pengetahuan, kaedah pengajaran, ketokohan serta keperibadian dalam menyampaikan pengajaran (Abdullah Ishak, 1989). Sharifah Nor Puteh dan Kamarul Azman (2011) menyatakan kesediaan merupakan kata adjektif atau kata sifat yang memberi gambaran bahawa seseorang individu berupaya bertindak di luar kebiasaan mengikut keupayaan dan kemahuan sendiri. Dalam konteks pendidikan masa kini, guru sekolah murid orang asli khususnya banyak mengalami perubahan dalam kaedah menyampaikan pengajaran kepada murid. Justeru, kesediaan guru untuk menghadapi perubahan seperti ini amat penting bagi memastikan pembelajaran alaf baharu dapat dilaksanakan dengan baik.

Antara aspek utama yang menjadi tumpuan kepada kesediaan guru ini adalah menerusi ilmu dan pengetahuan. Pengetahuan ditakrifkan sebagai kecekapan intelektual untuk mengingat semula serta mengenal pasti intipati khusus yang terkandung dalam sesebuah mata pelajaran (Padmanaban, Ruhizan & Mohd Isa, 2016). Dalam hal ini, guru perlu memiliki pengetahuan yang mendalam berkenaan KBS. Ini kerana dalam memastikan kredibiliti pendidik pada tahap yang tinggi, seorang pendidik mestilah sentiasa memantapkan diri mereka dengan pelbagai ilmu pengetahuan yang lebih meluas dan terkini (Zamri, Jamalul lail & Anita, 2019).

Menurut Sameer dan Adelina (2020), guru akan lebih cenderung serta berkeyakinan untuk menerima sebarang tugas yang telah dipertanggungjawabkan jika guru itu mempunyai kesediaan yang tinggi serta bermotivasi dalam perkara yang dilakukan. Oleh itu, semua guru khususnya guru-guru Pendidikan Islam haruslah menanamkan sikap bertanggungjawab agar sentiasa bersedia fizikal dan mental untuk melaksanakan KBS di sekolah.

Kesediaan Dari Aspek Pengetahuan

Menurut Zarina (2016), pengetahuan berperanan dalam menjelaskan sesuatu bagi meningkatkan pemahaman berkaitan sesuatu topik dan mempunyai tujuan tertentu. Dalam mengendalikan sesebuah proses pengajaran dan pembelajaran yang berimpak tinggi, perkara asas yang perlu dimiliki oleh para guru ialah pengetahuan. Oleh itu, guru perlu memastikan pengetahuan yang cukup dalam tatacara serta perlakuan solat supaya kem dapat dijalankan dengan baik dan berkesan. Dalam satu kajian yang telah dilaksanakan oleh Che Abd Rahman (2007) menunjukkan bahawa tahap pengetahuan guru yang tinggi menjadi salah satu faktor yang memberi kesan langsung dan mempengaruhi pengajaran seseorang guru.

Memiliki pengetahuan yang mapan bukan lagi menjadi satu keistimewaan buat guru malah merupakan satu tuntutan dan keperluan untuk mengukuhkan lagi proses pengajarannya. Sehubungan dengan itu, guru perlu bersedia dalam mendepani perubahan yang semakin mencabar dalam dunia pendidikan bagi memastikan mutu pengajaran dapat ditingkatkan.

Kesediaan guru dari aspek pengetahuan sebelum, semasa dan selepas pelaksanaan KBS adalah penting bagi memastikan objektif kem itu tercapai terutamanya dalam mengendalikan KBS terhadap murid orang asli ini. Hal ini demikian kerana tahap kognitif, keadaan persekitaran malahan perspektif murid-murid ini adalah masih di tahap yang sangat rendah berbanding murid-murid biasa diluar sana.

Kesediaan Dari Aspek Kemahiran

Selain pengetahuan, pelaksanaan KBS juga menuntut guru untuk memiliki kemahiran pengajaran yang tinggi dan kompeten seterusnya mengaplikasikan kemahiran ini menerusi amalan pengajaran dan pembelajaran di dalam kem. Nurulhuda (2013) berpendapat kemahiran juga merupakan satu kebolehan yang diperoleh melalui latihan atau pengalaman yang dilalui secara langsung oleh individu dan ia melibatkan penggunaan anggota atau badan. Nurzarina dan Rosli (2017) berpendapat bahawa guru perlu meningkatkan kefahaman dan menguasai kemahiran dalam melaksanakan sesuatu kaedah pengajaran bagi memastikan pencapaian murid dapat ditingkatkan.

Guru Pendidikan Islam di sekolah murid orang asli perlu lebih bersedia menambah baik kaedah pengajaran terkini menggunakan alat, bahan serta prasarana sedia ada disamping menitikberatkan kemahiran abad ke-21 seperti berkomunikasi dengan baik, berkolaborasi antara satu sama lain dan juga pembelajaran sendiri dalam pelaksanaan KBs di SMOA ini. Murid-murid asli ini pasti akan lebih tertarik dengan kemahiran guru mengaplikasi serta menerapkan elemen-elemen baharu dan canggih dalam pelaksanaan KBS sekaligus dapat menghasilkan impak yang lebih baik terhadap murid.

Kesediaan Dari Aspek Sikap Guru

Sikap merupakan suatu elemen yang mempengaruhi individu untuk memberikan penilaian terhadap sesuatu. Ianya terhasil berdasarkan perasaan, kepercayaan atau pemikiran seseorang Kartz (1960). Adibah dan Malathy (2010) berpendapat guru yang bersikap positif akan sentiasa bersedia untuk melakukan perubahan yang perlu mengikut keadaan semasa dalam memastikan mutu pengajaran sentiasa dapat dipertingkatkan. Sikap positif yang ada dalam diri guru mampu memberikan impak positif dalam meningkatkan keberkesanan proses pengajaran dan pembelajaran (Sofiah, Kamarul Azmi & Muhammad Azhar, 2016).

Menurut Omar dan Khuan (2005), dalam memastikan keberkesanan sesebuah penyampaian pengajaran, seseorang guru perlu mempunyai pengetahuan yang tinggi, memiliki kemahiran kreatif serta berkebolehan mengurus dan melaksanakan proses pengajaran dan pembelajaran di dalam kelas. Oleh yang demikian, kesediaan guru merangkumi aspek pengetahuan, kemahiran dan sikap yang positif merupakan kombinasi yang sesuai bagi mengukur tahap pelaksanaan sesuatu proses pembelajaran. Ketiga-tiga unsur ini merupakan pemboleh ubah yang menentukan kejayaan atau kegagalan sesebuah dasar baharu yang dilaksanakan oleh kementerian dalam mengangkat kualiti pendidikan negara.

Teori Kesediaan Thorndike

Teori Thorndike ini adalah yang terawal pernah dilakukan dan ianya dikaitkan dengan perkaitan rangsangan serta tindakbalas (Syed Ismail & Ahmad Subki, 2013). Singkatan teori ini disebut sebagai S-R iaitu Stimulus dan Rangsangan dan hubungan antara keduanya pula dihasilkan melalui beberapa hukum iaitu Hukum Kesediaan, Hukum Kesan dan Hukum Latihan. Hukum Kesediaan yang dicadangkan oleh Edward Lee Thorndike di dalam bukunya berjudul "*The Original Nature of Man*" pada tahun (1913) terbahagi kepada tiga bahagian iaitu;

i) Apabila sesuatu itu bersedia bertindak, beliau akan berpuas hati, ii) apabila sesuatu bersedia untuk bertindak, tidak melakukannya akan kecewa, iii) apabila sesuatu itu tidak bersedia bertindak, dipaksa bertindak, ianya akan mengecewakannya.

Dalam konteks kajian ini, menjadi satu keperluan untuk GPI itu bersedia dan mempersiapkan dirinya sebelum pelaksanaan KBS supaya apabila kem itu dilaksanakan, GPI tersebut akan berpuas hati dan natijah yang baik akan terhasil. Ini kerana melakukan sesuatu dengan keadaan bersedia dianggap sebagai kepuasan, begitulah sebaliknya. Tiga aspek kesediaan utama yang ditekankan dalam teori ini ialah aspek psikomotor, afektif dan kognitif. Ketiga-tiga aspek ini adalah sangat penting dalam mempersiapkan mental dan fizikal GPI dalam melaksanakan KBS di SMOA.

Model Guru Cemerlang Imam Al-Ghazali

Kajian ini dijalankan untuk mengkaji kesediaan guru pendidikan Islam terhadap pelaksanaan Kem Bestari Solat sekolah murid orang asli. Antara teori yang sesuai untuk mendasari kajian ini ialah Model Guru Cemerlang yang diterajui oleh Imam al-Ghazali (1967) sebagaimana yang telah dinukilkannya di dalam kitab *Ihya 'Ulum Addin* (2005). Menurut Kamarul Azmi dan Noor Fadhlina (2012), model ini meletakkan nilai ketakwaan dan hubungan dengan Allah sebagai asas utama yang perlu ada dalam diri seorang guru dan kemudiannya menghasilkan kualiti peribadi daripada tiga aspek iaitu ilmu, kemahiran dan keperibadian. Dalam konteks ilmu, guru perlu mempunyai kefahaman jelas berkenaan ilmu agama dan isi pelajaran manakala aspek pedagogi dan komunikasi pula menjadi elemen yang terkandung di bawah kemahiran. Selain itu, guru berkualiti menurut al-Ghazali juga mempunyai nilai keperibadian tinggi menerusi sifat kasihan dan hikmah. Ketiga-tiga elemen ini perlu diintegrasikan untuk memberi impak terhadap pembelajaran pelajar.

Berkesinambungan daripada model ini, al-Ghazali (2005) telah menghasilkan Model Konseptual Pendidikan. Menurut Mohd Syaubari & Ahmad Yunus (2016), model ini membahaskan tiga elemen penting bagi menjadikan proses pengajaran dan pembelajaran di dalam kelas memberi kesan kepada para pelajar dan juga merupakan nilai tambah kepada asas yang telah diperkenalkan oleh Kementerian Pendidikan Malaysia di dalam Pdp. Tiga kerangka utama yang terkandung dalam model ini ialah; i) kefahaman mengenai konsep ilmu, ii) penguasaan kemahiran-kemahiran dalam pengajaran, dan iii) nilai pembentukan penghayatan di dalam kelas. Kesemua elemen ini dilihat mempunyai perkaitan dan kesinambungan dengan konsep kesediaan yang menunjangi kajian ini.

Model Guru Cemerlang Imam al-Ghazali ini juga selari dengan Model Standard Guru Malaysia. Bahagian Pendidikan Guru (2009) telah menggariskan tiga standard kompetensi yang perlu dimiliki oleh guru. Aspek pertama ialah amalan nilai profesionalisme keguruan. Perkara ini disusuli dengan aspek kedua iaitu pengetahuan dan kefahaman serta aspek terakhir melibatkan kemahiran pengajaran dan pembelajaran. Oleh yang demikian, kajian ini yang memberi fokus kepada elemen pengetahuan, kemahiran dan amalan pengajaran guru dilihat bertepatan bagi menilai pelaksanaan dan keberkesanan pelaksanaan KBS menerusi proses pembelajaran yang dilaksanakan di sekolah.

Model Amalan Pengajaran Caroll

Konsep kesediaan dalam konteks kajian ini juga memfokuskan kepada amalan pengajaran di sekolah. Caroll (1989) dalam Model Amalan Pengajaran yang dihasilkannya menjelaskan bahawa pengajaran guru yang efektif dipengaruhi oleh lima elemen yang utama iaitu sikap guru, ketekunan, kebolehan untuk memahami pengajaran, peluang dan pengajaran yang berkualiti (Mohd Yusri & Aziz, 2014). Menurut Shahril (2005), seseorang guru yang memiliki

amalan pengajaran berkualiti berkebolehan dalam menyampaikan isi pengajaran, konsep atau kemahiran yang memudahkan pelajar untuk memahami dan mengingat di samping menyeronokkan.

Pengintegrasian kemahiran Teknologi Maklumat dan Komunikasi (TMK), aktiviti permainan dan lain-lain akan menarik minat murid untuk mengikuti kem seterusnya meningkatkan keberkesannya. Perkara ini bertitik tolak daripada elemen pengetahuan dan kemahiran yang dimiliki oleh guru. Menurut Dunkin dan Biddle (1974), pengajaran seseorang guru yang berkesan bergantung kepada lima faktor utama iaitu guru, pelajar, faktor sekolah dan bilik darjah, proses pengajaran dan pembelajaran di dalam bilik darjah serta produk yang dihasilkan. Dalam hal ini, guru perlu memiliki personaliti, kemahiran mengajar, gaya pengajaran dan keperibadian yang tinggi bagi menghasilkan pelajar yang mempunyai personaliti diri, cara belajar, motivasi dan sikap. Keberkesanan sesebuah proses pengajaran dan pembelajaran dilihat berjaya apabila guru berupaya untuk mengubah pelajar menerusi perubahan dalam jangka masa yang pendek mahupun panjang (Kamarul Azmi & Noor Fadhlina, 2012).

Proses pengajaran dan pembelajaran di dalam bilik darjah adalah sinonim dengan penglibatan guru dan pelajar. Justeru, amalan pengajaran guru perlu sentiasa ditambah baik bagi mewujudkan pendidikan yang efektif dan komprehensif terhadap semua isi pembelajaran yang disampaikan menerusi pelbagai aktiviti bagi menghasilkan perubahan dalam tingkah laku pelajar (Rahil, Habibah & Kamariah, 1997). Menurut Mohammad Johdi (2009), amalan pengajaran yang berkualiti dan berkesan akan dapat mewujudkan keceriaan, memastikan penglibatan pelajar secara maksimum, merangsang minat dan motivasi, mampu menjelaskan kesemua isi pelajaran, membuat penilaian serta menjalankan tindakan susulan dalam bentuk pengayaan atau pemulihan. Dalam konteks kajian ini, amalan pengajaran guru adalah seperti sikap dan ketekunan, kebolehan guru dalam memahami ilmu berkenaan solat, memberi peluang dan ruang kepada murid untuk bersoal jawab. Penyebatian kesemua elemen ini dalam proses pengajaran yang dijalankan oleh guru pastinya mampu menjana dan menarik minat murid untuk mengikuti kem yang dianjurkan 4 kali setahun ini.

KESIMPULAN

Dalam dunia yang serba moden kini, guru haruslah melengkapkan diri dengan ilmu pengetahuan serta mempunyai kesediaan tidak kira dalam apa jua bidang termasuklah Pendidikan Islam. Dalam menghadapi isu pengabaian solat, pelbagai aspek perlu ditambahbaik oleh GPI dari semasa ke semasa khususnya dalam aspek kesediaan diri guru itu sendiri. Disamping itu, bagi menarik minat pelajar, khususnya murid orang asli sewaktu melaksanakan Kem Bestari Solat ini, pelbagai inisiatif harus direncanakan sebaik mungkin oleh GPI selaku pendokong utama pelaksanaannya disekolah. Oleh yang demikian, kesediaan guru merupakan aset penting kepada kelangsungan kerjaya seorang guru sama ada di kawasan bandar, luar bandar mahupun di kawasan pedalaman.

Tuntasnya matlamat serta tujuan utama guru-guru ini mengajar dan mendidik anak bangsa akan dapat dijalankan dengan sempurna dan teratur jika adanya kemahiran serta kesediaan berdasarkan ilmu yang sentiasa diperbaharui. Murid-murid dan institusi pendidikan amnya akan mendapat faedah yang maksimum dari kesediaan serta kemahiran guru-guru menyampaikan ilmu dalam apa jua keadaan. Matlamat serta objektif utama proses Pdp akan dapat diterjemahkan dengan sempurna, teratur dan berkesan jika adanya kesediaan dari aspek pengetahuan, kemahiran serta sikap guru yang positif untuk mengadaptasi situasi dalam menangani isu-isu yang timbul semasa proses pelaksanaannya.

RUJUKAN

- Abas Morshidi & Saemah Rahman. (2017). Kecekapan kepelbagaian budaya guru novis di pedalaman Sarawak. *Seminar Penyelidikan Pendidikan: 1487-1495*. IPG Kampus Batu Lintang, Sarawak.
- Abd. Halim Hadi. (2020). 80 peratus tidak solat penuh itu hasil kajian. *Malakat Tribune*. Diakses dari: <https://www.malakatribunenews.com/2020/11/80-peratus-tidak-solat-penuh-itu-hasil-kajian-coach-fadzil/> [1 April 2022]
- Abdullah Ishak. (1989). *Sejarah Perkembangan Pelajaran dan Pendidikan Islam*. Kuala Lumpur: Badan Dakwah dan Kebajikan Malaysia.
- Adibah Abdul Latif & Malathy Kuberan. (2010). Kesediaan bakal guru siswazah yang mengikuti program khas pensiswazahan guru untuk mengajar mata pelajaran lukisan. Satu kajian kes.
- Al-Ghazali, Abu Hamid Muhammad Ibn Muhammad. (2005). *Ihya' 'Ulum al-Din. Tahqiq: Muhammad Sa'id Muhammad*. Qahirah: Dar al-Bayan al-'Arabi.
- Ardi Marwan, Bambang Sumintono & Nora Mislana. (2012). Revitalising rural schools: A challenge for Malaysia. Dlm. *Educational Issues, Research and Policies: 172-188*. Skudai Johor Bahru: RMC-UTM Press.
- Bahagian Pendidikan Guru (BPG). (2009). *Standard Guru Malaysia*. Putrajaya: Kementerian Pendidikan Malaysia.
- Baharom Mohamad. (2010). *Gaya Pengajaran dan Pembelajaran*. Selangor: PTS Profesional Publishing Sdn. Bhd.
- Carroll, J. (1989). The Carroll Model: a 25 years retrospective and prospective view. *Educational Research, 18*: 26-31.
- Che Abd Rahman, A. S. (2007). Pengetahuan kandungan dan pedagogi guru Pendidikan moral tingkatan 4 di sekolah. *Tesis Dr. Fal*, Universiti Malaya.
- Cheung, W. M., & Wong, W. Y. (2014). Does lesson study work?: A systematic review on the effects of lesson study and learning study on teachers and students. *International Journal for Lesson and Learning Studies, 3*(2): 137-149.
- Crispina Gregory K. Han, Magret Aneyra Rap & Lawrence Alan Anak Bansa. (2018). Formal education in rural schools of Sabah, Malaysia. Dlm. Lay Yoon Fah (pnyt.) *Education for Underprivileged Primary and Secondary Students in Malaysia: The Way Forward: 61-80*. Kota Kinabalu: Penerbit Universiti Malaysia Sabah.
- Dunkin, M. J. & Biddle, B. J. (1974). *The Study of Teaching*. New York: Holt, Rinehart and Winston.
- Hasna Bidin, Ahmad Syukran Baharuddin & Mohd Ismail Mustari. (2015). Kefahaman Ibadat Solat Fardhu dalam Kalangan Pelajar Muslim: Kajian Tinjauan di Kolej Komuniti Bukit Beruang, Melaka. *Tesis Sarjana Falsafah Fakulti Tamadun Islam, Universiti Teknologi Malaysia: 21-34*. Penerbit UTM Press.
- Hassan Omar. (2019). Lebih 700 murid tak boleh mengaji al-Quran. *MyMetro*. Diakses dari: <https://www.hmetro.com.my/mutakhir/2019/11/517173/lebih-700-murid-tak-boleh-mengaji-al-quran> [6 April 2022]
- Ibrahim Hashim, Misnan Jemali, Muhammad Akramin, Mohd Abdul Nasir, Ahmad Zulfikar Shah, Zanariah Noor & Mohd Abdul Aziz Hasanudin Abd Hamid. (2009). Draf laporan akhir penilaian pelaksanaan Program j-QAF di Sekolah Rendah Kementerian Pelajaran Malaysia. *Projek Penyelidikan*. Universiti Pendidikan Sultan Idris.
- Kamarul Azmi Jasmi & Noor Fadhlina Nawawi. (2012). Model guru berkualiti dari perspektif tokoh pendidikan Islam dan barat. *Seminar Antarabangsa Perguruan dan Pendidikan Islam (SEAPPI2012): 233-238*.

- Katz, D. (1960). The functional approach to the study of attitudes. *Public Opinion Quarterly*, 24(2): 163-204.
- Kementerian Pendidikan Malaysia. (2004). *Buku Panduan Dasar, Pelaksanaan dan Pengurusan Kurikulum j-QAF*. Cetakan Pertama. Bahagian Kurikulum Pendidikan Islam dan Moral, Kuala Lumpur. Penerbit: Jabatan Pendidikan Islam dan Moral.
- Kementerian Pendidikan Malaysia. (2014). *Pekeliling Perkhidmatan; Elaun Khas Mengikut Lokasi dan Tahap Kesusahan Bagi Pegawai Perkhidmatan Pendidikan dan Anggota Kumpulan Pelaksanan di bawah KPM yang Berkhidmat di Sekolah Pedalaman*. Putrajaya: Kementerian Pendidikan Malaysia.
- Mastura Ismail. (2020). Guru muda gigih redah hutan demi murid. *Utusan Borneo Online*.
- Mook Son Sang. (2002). *Pedagogi: Pelaksanaan Pengajaran*. Kuala Lumpur: Kumpulan Budiman Sdn. Bhd.
- Mohamad Zahier Zamahshari & Zamri Mahamod. (2021). Tahap kesediaan guru sekolah murid orang asli dalam pengajaran dan pembelajaran di rumah. *Seminar Majlis Dekan, Universiti Kebangsaan Malaysia, 14-15 September 2021*: 812-831.
- Mohammad Johdi Salleh. (2009). Guru efektif dan peranan guru dalam mencapai objektif persekolahan sekolah rendah: perspektif guru besar. *Seminar Penyelidikan Pendidikan Institut Perguruan Batu Lintang*.
- Mohd Syaubari Othman & Ahmad Yunus Kassim. (2016). Elemen kemahiran berfikir aras tinggi (KBAT) di dalam amalan pengajaran guru pendidikan Islam menurut Imam Ghazali. *Jurnal Sultan Alauddin Sulaiman Shah*, 3(2): 80-91.
- Mohd Yusri & Wan Abd Aziz. (2014). Amalan kepimpinan pengajaran pengetua Terengganu. *Persidangan Majlis Pengetua Sekolah-sekolah Malaysia Terengganu 2011*.
- Muhammad Faizal A. Ghani, Norfariza Mohd Radzi, Husaina Banu Khanayatullah, Saedah Abdullah, Faisol Elham, Maszuria A. Ghani & Amalina Ayub. (2017). Masalah Displin Murid Islam: Strategi dan Penyelesaian Terhadap kurikulum Pendidikan Islam. *Jurnal Hadhari*, 9(1): 91-110.
- Muhammad Fathi Yusof & Ros Izanuri Jamaludin. (2013). *Anakku penyejuk mata*. Kuala Lumpur: Telaga Biru Sdn. Bhd.
- Noor Azimah Surip. (2012). Penilaian Pelaksanaan Model Kem Bestari Solat program j-QAF di Sekolah Rendah: Kajian di Sekolah Kebangsaan Daerah Kuala Selangor. *Projek Penyelidikan Sarjana Pendidikan: Universiti Kebangsaan Malaysia*.
- Nor Azah Abdul Aziz. (2011). Kaedah menangani stress dengan solat. *Journal of Islamic and Arabic Education*, 3(2): 1-10.
- Nora Mahpar. (2021). Jangan canang PdPR jika sekolah pedalaman masih mengemis kemudahan asas, kata pakar pendidikan. *Free Malaysia Today*.
- Norhayati Ab. Ghani @ Rani, Khadijah Abdul Razak & Mohd Aderi Che Noh. (2016). Solat dan hubungannya dengan pendidikan. *Jurnal Teknikal dan Sains Sosial*, Bilangan 5 Jilid 1: 16-24.
- Norma Jusof, Khadijah Abdul Razak & Mohd Aderi Che Noh. (2016). Pelaksanaan Kem Bestari Solat (KBS) di sekolah rendah Daerah Sepang, Selangor. *Wacana Pendidikan Islam Siri ke 11, 15-16 November 2016*. Institut Latihan Islam Malaysia (ILIM), Bangi, Selangor.
- Nurulhuda Mohd Sukri. (2013). Tahap Kesediaan Guru terhadap pelaksanaan Pembelajaran Berasaskan kompetensi di Kolej Vokasional. *Tesis Sarjana Pendidikan*. Universiti Teknologi Malaysia.
- Nurzarina Amran, & Rosli Roslinda. (2017). Kefahaman guru tentang kemahiran abad ke-21. Dlm; S. Z. Ibrahim, A. E. Mat Zain, S. Sharil, & A. N. Zainal Arifin (Eds.), *Prosiding Persidangan Antarabangsa Sains Sosial dan Kemanusiaan (p. 412)*. Selangor: Pusat Pengajian Teras, Kolej Universiti Islam Antarabangsa Selangor.

- Omar Abdull Kareem & Khuan Wai Bing. (2005). Perkembangan profesional guru secara berterusan: perspektif pembangunan sumber manusia. *Jurnal Masalah Pendidikan Universiti Malaya*: 131-141.
- Padmanaban Madawan, Ruhizan Muhammad Yasin & Mohd Isa Hamzah. (2017). Pengetahuan, sikap dan kesediaan pelajar kolej matrikulasi terhadap kemahiran berfikir aras tinggi (KBAT) dalam pembelajaran. *Seminar Pendidikan Transdispilin (STEd2017), Fakulti Pendidikan, Universiti Kebangsaan Malaysia*: 182-187.
- Rahil Mahyuddin, Habibah Elias & Kamariah Abu Bakar. (1997). *Pedagogi 2: Pelaksanaan Pengajaran*. Selangor: Logman.
- Ruhaida Abdullah & Nurul Ilyana Muhd Adnan. (2018). Pelaksanaan program amali solat dalam Perkara Asas Fardu Ain (PAFA) dalam kalangan pelajar tingkatan dua. *Journal of Advanced Research in Social and Behavioural Sciences 11*, Issue 1 (2018): 1-16.
- Sameer Ahmed Boset & Adelina Asmawi. (2020). Mediating effect of work motivation on the relationship between competency and professional performance of EFL teachers. *Akademika: Journal of Southeast Asia Social Sciences and Humanities*, 90(1): hlm. 63-75.
- Shahril @ Charil Hj Marzuki. (2005). Amalan pengajaran guru berkesan: kajian di beberapa sekolah menengah Malaysia. *Seminar Penyelidikan Pendidikan Maktab Perguruan Batu Lintang, Kuching*.
- Sharifah Nor Puteh & Kamarul Azman Abd Salam. (2011). Tahap kesediaan penggunaan ICT dalam pengajaran dan kesannya terhadap hasil kerja dan tingkah laku murid Prasekolah. *Jurnal Pendidikan Malaysia*, 36(1): 25-34.
- Sharifah Nur Abu. (2012). Pengamalan solat fardhu dalam kalangan pelajar Politeknik Kuching Sarawak. *International Seminar on Research in Islamic Studies II (ISRIS II)*. Kuala Lumpur.
- Shukri Ahmad, Yahya Don, Wan Abdul Rahman Khudri Wan Abdullah, Madiha Mohammed Ibrahim & Shahril Fazli Mat Hussain. (2014). Penghayatan solat dan pengimarahannya masjid: kajian dalam kalangan pelajar Universiti Utara Malaysia. *Proceeding of the Social Sciences Research ICSSR 2014*. Kota Kinabalu, Sabah, Malaysia: 786-797.
- Siti Fatimah Ahmad & Abdul Halim Tamuri. (2010). Persepsi guru terhadap penggunaan bahan bantu mengajar berasaskan teknologi maklumat dalam pengajaran j-QAF. *Journal of Islamic and Arabic Education*, 2(2): 53-64.
- Siti Zaleha Ibrahim, Norziah Othman, Phayilah Yama. (2016). Penghayatan dan pelaksanaan solat berjemaah dalam kalangan pelajar institusi pengajian tinggi Islam. *International Conference on Aqidah, Dakwah and Syariah (IRSYAD) 2016*: 490-506.
- Sofiah Mohamed, Kamarul Azmi Jasmi & Muhammad Azhar Zailaini. (2016). Akhlak guru dalam pengajaran dan pembelajaran Pendidikan Islam. *Jurnal Akademika*, 86(2): 31-42.
- Suhaila Nadzri, Suhaily Md Shamsudin, Siti Syuhada Abd Rahman, Ahmad A'toa' Mokhtar, Azri Rizal Md Razalie. (2018). Isu-isu pengabaian solat dalam kalangan remaja di negeri Selangor. *Book of Masjid, Zakat and Waqf Management 2018 (IMAF 2018)*. Bangi, Selangor, Malaysia.
- Suhaimi Muhammad. (2007). *Tahap kesediaan guru terhadap pelaksanaan model pengajaran simulasi bagi mata pelajaran Pendidikan Islam*. Tesis Sarjana Pendidikan. Universiti Teknologi Malaysia.
- Syed Ismail Syed Mustapa & Ahmad Subki Miskon. (2013). *Murid dan Alam Belajar*. Kuala Lumpur: Freemind Horizons Sdn. Bhd.
- Zamri Mahamod, Jamalul lail Abdul Wahab & Anita Abdul Rahman. (2019). *Pembelajaran Sepanjang Hayat*. Bangi: Penerbit Universiti Kebangsaan Malaysia.

Zarina Abdul Rashid. (2016). Tahap kesediaan guru dalam aspek pengetahuan dan keperluan latihan berfokuskan aplikasi KBAT. *Tesis Sarjana Pendidikan*. Universiti Tun Hussein Onn Malaysia.



UNIVERSITI

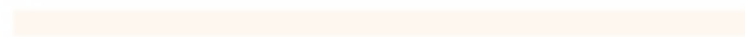

MALAYSIA

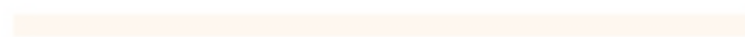

KELANTAN

Kajian Cadangan Program Baharu di Kolej Komuniti Lipis Mengikut Pandangan Pelajar Sekolah Menengah Harian di Daerah Lipis

Nurul Farhana Mokhtar
Kolej Komuniti Lipis
farhana.mokhtar@kklipis.edu.my

Shah Rulbani Zakaria
Kolej Komuniti Lipis
shahrulbani@kklipis.edu.my

ABSTRAK

Kolej Komuniti di Malaysia berperanan penting dalam menyediakan keperluan latihan dan kemahiran serta memberi peluang pendidikan kepada lepasan menengah sebelum melanjutkan pendidikan ke peringkat yang lebih tinggi mahupun memasuki pasaran kerja. Kolej Komuniti Lipis adalah salah sebuah kolej komuniti yang menawarkan Program Pengembaraan Pelancongan di Negeri Pahang. Kadar enrolmen bagi program ini tidak memberangsangkan walaupun pelbagai usaha promosi telah dijalankan. Perkara ini telah mendapat perhatian pihak yang berkaitan bahawa satu kajian keperluan program baharu perlu dilaksanakan bagi mengatasi masalah ini. Justeru, kajian ini dijalankan untuk mengetahui cadangan program baharu yang sesuai ditawarkan di Kolej Komuniti Lipis mengikut pandangan para pelajar sekolah menengah harian di Daerah Lipis. Kajian ini berbentuk tinjauan dengan menggunakan instrumen borang soal selidik melibatkan 172 orang responden. Dapatan kajian dianalisis dengan menggunakan perisian 'Statistical Package of the Sosial Sciences' (SPSS) versi 22. Dapatan analisis deskriptif yang melibatkan min dan sisihan piawai menunjukkan bahawa item pengetahuan para pelajar mengenai bidang yang wujud di Malaysia berada pada tahap rendah, item minat para pelajar terhadap program yang ditawarkan berada pada tahap sederhana, item pengetahuan pelajar mengenai program yang mampu menyumbang kepada perkembangan kerjaya di masa hadapan berada pada tahap sederhana, item pengetahuan pelajar mengenai program yang dapat memenuhi keperluan industri di masa hadapan berada pada tahap sederhana dan item program baharu yang sesuai ditawarkan di Kolej Komuniti Lipis adalah Program Kuliner yang menduduki tempat tertinggi diikuti dengan Program Pastris dan Program Automotif. Sehubungan itu, pihak kami berharap agar cadangan ini dapat dipertimbangkan dengan sewajarnya oleh pihak yang berkaitan.

Kata Kunci: program baharu, Kolej Komuniti Lipis, pelajar sekolah menengah harian

PENGENALAN

Kolej Komuniti di Malaysia berperanan penting dalam menyediakan keperluan latihan dan kemahiran serta memberi peluang pendidikan kepada para pelajar lepasan menengah sebelum melanjutkan pendidikan ke peringkat yang lebih tinggi mahupun memasuki pasaran kerja (Sarimah et al. 2013). Antara misi Pelan Strategik Politeknik dan Kolej Komuniti 2018-2025 ialah menyediakan akses yang meluas kepada program Pendidikan Teknikal dan Latihan Vokasional (TVET) berkualiti dan diiktiraf dan melahirkan graduan holistik, berciri keusahawanan dan seimbang. Bagi program sijil di kolej komuniti, kurikulum dibangunkan adalah bersama dengan pihak industri secara berperingkat dengan tujuan supaya lepasan kolej komuniti dapat mudah memasuki pasaran kerja apabila mereka tamat belajar kelak manakala modul-modul yang dihasilkan oleh kolej komuniti juga adalah relevan dengan keperluan pasaran kerja semasa supaya dapat membantu memantapkan kemahiran pelajar menjadi tenaga kerja yang mahir dan berkualiti (Kamalulrifin et al 2020).

Siti Hamisah (2019) menyatakan bahawa program baharu yang ditawarkan harus selari dengan keperluan industri dalam era Revolusi Industri 4.0. Sehubungan dengan itu, program baharu yang ingin ditawarkan di sesebuah institusi pengajian tinggi adalah relevan dengan perkembangan semasa serta boleh menjamin peluang pekerjaan selepas pelajar mereka menamatkan pengajian nanti. Oleh itu, pelbagai program pengajian yang memenuhi permintaan industri dan responsif ditawarkan di kolej komuniti di Malaysia supaya tidak ada pelajar lepasan sekolah menengah yang layak menyambung pengajian tetapi terpinggir dari arus perdana pengajian tinggi.

Isu dan Permasalahan

Kursus Pengembaraan Pelancongan yang ditawarkan di Kolej Komuniti Lipis mempunyai enrolmen yang kurang memberangsangkan sejak awal penubuhannya. Walaupun kurang persaingan daripada institusi pengajian tinggi lain di Daerah Lipis dan pelbagai usaha promosi telah dijalankan namun masih lagi belum memenuhi norma yang ditetapkan (Wan Mohd Zul et al., 2018). Getz (1994) menyatakan bahawa bidang pelancongan bukan pilihan utama kerjaya muda-mudi, maka program pelancongan bukan menjadi bukanlah menjadi pilihan utama untuk golongan muda mengikutinya di Institusi Pengajian tinggi (IPT) (Noor Suhaila dan Kamal Izzuwan 2006). Selain itu, wujud juga faktor pelajar yang mengikuti program pelancongan di IPT tidak mempunyai hasrat untuk berkerjaya dalam bidang ini kerana mereka beranggapan bahawa bidang kerjaya adalah terhad selain perlu bersaing dengan graduan dalam bidang lain (Azurin 2003).

Sehubungan itu, penulis merumuskan bahawa masalah enrolmen Program Pengembaraan Pelancongan yang ditawarkan di Kolej Komuniti Lipis berkemungkinan disebabkan oleh program ini bukanlah pilihan utama para pelajar. Justeru, satu kajian dilaksanakan untuk melihat keperluan program baharu untuk ditawarkan kepada penduduk Daerah Lipis yang boleh memenuhi kehendak kebanyakan pelajar dan masyarakat setempat.

Keperluan Program Baharu di Kolej Komuniti Lipis

Kolej Komuniti Lipis perlu melaksanakan satu kajian mengenai keperluan program baharu yang sesuai ditawarkan di Daerah Lipis mengikut pandangan penduduk di daerah ini terutamanya dalam kalangan pelajar sekolah menengah harian yang bakal melanjutkan pelajaran apabila mereka tamat di peringkat menengah. Cadangan penubuhan program baharu ini bukan sahaja perlu mengambil kira permintaan pasaran kerja sahaja bahkan juga perlu dilihat dari aspek kehendak atau keperluan negara (Buku Panduan Penyediaan Program Siswazah Baharu 2017). Norhidayah (2017) menyatakan bahawa pemilihan program pengajian hendaklah mengambil kira berdasarkan kehendak pasaran kerja bagi memastikan pelajar tidak menganggur apabila mereka tamat pengajian kelak.

Objektif Kajian

- a) Mengetahui tahap pengetahuan pelajar sekolah menengah harian di Daerah Lipis mengenai bidang pengajian yang wujud di Malaysia.
- b) Mengetahui tahap minat pelajar sekolah menengah harian di Daerah Lipis terhadap program yang ditawarkan.
- c) Mengetahui tahap pengetahuan pelajar mengenai program yang mampu menyumbang kepada perkembangan kerjaya pada masa hadapan di Daerah Lipis.
- d) Mengetahui tahap pengetahuan pelajar mengenai program yang dapat memenuhi keperluan industri pada masa hadapan.

- e) Mengenal pasti program baharu yang sesuai ditawarkan di Kolej Komuniti Lipis.

Signifikan Kajian

Kajian bertujuan untuk memberi cadangan satu program baharu yang sesuai ditawarkan di Kolej Komuniti Lipis yang dapat memenuhi kehendak pelajar sekolah menengah harian di Daerah Lipis.

METODOLOGI KAJIAN

Kajian ini berbentuk kuantitatif iaitu kajian tinjauan dengan menggunakan borang soal selidik sebagai instrumen. Borang soal selidik ini diedarkan kepada pelajar sekolah menengah harian di Daerah Lipis yang dipilih secara rawak berkelompok dan melibatkan soalan-soalan demografi dan soalan berkaitan penawaran program baharu.

Populasi Dan Sampel Kajian

Populasi kajian ini adalah pelajar sekolah menengah harian di Daerah Lipis. Populasi mereka adalah seramai 972 orang berdasarkan data dari Pejabat Pendidikan Daerah Lipis pada tahun 2020. Justeru itu, dalam kajian ini, jumlah sampel yang akan terlibat ialah seramai 172 orang. Kothari (2004) menyatakan bahawa jika bilangan sampel sebanyak 10% hingga 20% daripada populasi adalah memadai. Schumacher dan McMillan (2014) juga ada menyatakan bahawa bagi kajian tinjauan, bilangan subjek yang sesuai adalah lebih kurang 100 responden (Muhammad Jeffery Hizwan, 2018).

Instrumen Kajian

Satu set soal selidik yang mengandungi lima (5) bahagian digunakan dalam kajian ini iaitu bahagian pertama adalah demografi responden dan pengetahuan mengenai bidang pengajian yang wujud di Malaysia; bahagian kedua adalah minat responden terhadap program yang ditawarkan; bahagian ketiga adalah pengetahuan responden mengenai program yang mampu menyumbang kepada perkembangan kerjaya pada masa hadapan; bahagian keempat adalah pengetahuan responden mengenai program yang dapat memenuhi keperluan industri pada masa hadapan; dan bahagian kelima adalah pendapat responden mengenai program baharu yang sesuai ditawarkan di Kolej Komuniti Lipis. Soal selidik ini diambil dari Bahagian Perancangan Program dan Institusi, Jabatan Pengajian Politeknik dan Kolej Komuniti (JPPKK). Penerangan instrumen ini seperti dalam Jadual 1 berikut.

Jadual 1: Penerangan Kandungan Instrumen Kajian

Bahagian	Kandungan	Bilangan item
1	Demografi	14
2	Minat terhadap program yang ditawarkan	13
3	Pengetahuan mengenai program yang mampu menyumbang kepada perkembangan kerjaya	12
4	Pengetahuan mengenai program yang dapat memenuhi keperluan industri	12
5	Program baharu yang sesuai ditawarkan di Kolej Komuniti Lipis	12
Jumlah item		63

Untuk mengisi instrumen soal selidik ini, responden diminta untuk menanda (√) pada ruang yang telah disediakan. Maklum balas persetujuan adalah seperti Jadual 2 berikut:

Jadual 2: Skala Pengukuran Kajian

Kod	Skala
1	Sangat Tidak Setuju
2	Tidak Setuju
3	Kurang Setuju
4	Setuju
5	Sangat Setuju

Prosedur Penganalisisan Data

Analisis Deskriptif

Dalam kajian ini, data yang dikumpul daripada soal selidik diproses dan dianalisis menggunakan program SPSS Versi 22. Data-data daripada borang soal selidik dan pemerhatian dianalisis dengan menggunakan statistik deskriptif seperti peratus dan frekuensi. Skor min dibuat seperti dalam Jadual 3.

Jadual 3: Penilaian Skor Min

Skor min	Interpretasi
3.67 hingga 5.00	Tinggi
2.34 hingga 3.66	Sederhana
1.00 hingga 2.33	Rendah

Sumber: Sumarni dan Jamil Ahmad, (2002)

DAPATAN KAJIAN

Berikut adalah dapatan kajian dan analisis kajian berdasarkan borang soal selidik yang diedarkan di Daerah Lipis mengenai program baharu yang akan ditawarkan di Kolej Komuniti Lipis.

Analisis demografi dan tahap pengetahuan pelajar mengenai bidang yang wujud di Malaysia

Jadual 4: Demografi Pelajar

Demografi	Kekerapan	Peratus
<i>Jantina</i>		
Lelaki	73	42.4
Perempuan	99	57.6
<i>Aliran Pengajian</i>		
Sains	25	14.5
Sastera	88	51.2
Teknik dan vokasional	20	11.6
Lain-lain	39	22.7

Jadual 4 menunjukkan bahawa seramai 172 orang responden pelajar yang terlibat dalam kajian ini. Berdasarkan jantina, pelajar lelaki seramai 73 (42.4%) orang dan pelajar perempuan seramai 99 (57.6%) orang. Daripada jumlah tersebut, 25 (14.5%) orang adalah pelajar aliran sains, 88 (51.2%) orang aliran sastera, 20 (11.6%) orang aliran teknik dan vokasional dan 39 (22.7%) orang dari lain-lain aliran.

Analisis deskriptif yang melibatkan min dan sisihan piawai dijalankan untuk menentukan pengetahuan pelajar mengikut bidang yang wujud di Malaysia. Hasil analisis deskriptif seperti Jadual 5 berikut.

Jadual 5: Analisis pengetahuan pelajar mengenai bidang yang wujud di Malaysia

No	Item	Min	Sisihan Piawai	Interpretasi
1	Kulinari (Masakan)	3.09	0.944	Sederhana
2	Pastri (Kek, Tart, Pai, Roti Kuih-Muih & Lain-Lain)	2.92	1.344	Sederhana
3	Bioteknologi Pertanian	2.23	1.004	Rendah
4	Akuakultur (Perikanan)	2.02	0.996	Rendah
5	Seni Kraf Tangan	2.35	0.985	Sederhana
6	Teknologi Elektrik	2.12	0.988	Rendah
7	Pelancongan dan Pengembaraan	2.38	1.027	Sederhana
8	Teknologi Penyejukan & Penyamanan Udara	1.86	0.919	Rendah
9	Animasi 3D	1.91	0.987	Rendah
10	Lanskap (Pemandangan Alam sesuatu kawasan)	2.20	0.954	Rendah
11	Kimpalan (Welding)	2.23	1.192	Rendah
12	Automotif (Servis Kenderaan Ringan seperti motor dan kereta)	2.47	1.196	Sederhana
Keseluruhan		2.31	1.044	Rendah

Jadual 5 menunjukkan bahawa item pengetahuan pelajar mengenai bidang yang wujud di Malaysia berada pada tahap rendah. Item yang mempunyai min yang tinggi ialah Kulinari (min = 3.09 dan sp = 0.944), diikuti dengan item Pastri (min = 2.92 dan sp = 1.344) dan item Automotif (min = 2.47 dan sp = 1.196). Secara keseluruhannya menunjukkan bahawa pengetahuan pelajar mengenai bidang yang wujud di Malaysia berada pada tahap rendah (min = 2.31 dan sp = 1.044).

Analisis minat pelajar terhadap program yang ditawarkan

Analisis deskriptif yang melibatkan min dan sisihan piawai dijalankan untuk menentukan minat pelajar terhadap program yang ditawarkan. Hasil analisis deskriptif seperti Jadual 6 berikut.

Jadual 6: Analisis minat pelajar terhadap program yang ditawarkan

No	Item	Min	Sisihan Piawai	Interpretasi
1	Kulinari (Masakan)	3.73	1.306	Tinggi
2	Pastri (Kek, Tart, Pai, Roti Kuih-Muih & Lain-Lain)	3.63	1.236	Sederhana
3	Bioteknologi Pertanian	2.97	1.166	Sederhana

4	Akuakultur (Perikanan)	2.71	1.080	Sederhana
5	Seni Kraf Tangan	3.04	1.053	Sederhana
6	Teknologi Elektrik	2.91	1.842	Sederhana
7	Pelancongan dan Pengembaraan	3.20	1.166	Sederhana
8	Teknologi Penyejukan & Penyamanan Udara	2.71	1.163	Sederhana
9	Animasi 3D	2.81	1.221	Sederhana
10	Lanskap (Pemandangan Alam sesuatu kawasan)	2.95	1.215	Sederhana
11	Kimpalan (Welding)	2.85	1.356	Sederhana
12	Automotif (Servis Kenderaan Ringan seperti motor dan kereta)	3.08	1.336	Sederhana
Keseluruhan		3.04	1.261	Sederhana

Jadual 6 menunjukkan bahawa item minat pelajar terhadap program yang ditawarkan berada pada tahap sederhana. Item yang mempunyai min yang tinggi ialah Kulineri (min = 3.73 dan sp = 1.036), diikuti dengan item Pastri (min = 3.63 dan sp = 1.236) dan item Pelancongan dan Pengembaraan (min = 3.2 dan sp = 1.166). Secara keseluruhannya menunjukkan bahawa minat pelajar terhadap program yang ditawarkan berada pada tahap sederhana (min = 3.04 dan sp = 1.261).

Analisis pengetahuan pelajar mengenai program yang mampu menyumbang kepada perkembangan kerjaya di masa hadapan

Analisis deskriptif yang melibatkan min dan sisihan piawai dijalankan untuk mengenalpasti pengetahuan pelajar mengenai program yang mampu menyumbang kepada perkembangan kerjaya di masa hadapan. Hasil analisis deskriptif seperti Jadual 7 berikut.

Jadual 7: Analisis pengetahuan pelajar mengenai program yang mampu menyumbang kepada perkembangan kerjaya di masa hadapan

No	Item	Min	Sisihan Piawai	Interpretasi
1	Kulineri (Masakan)	3.86	1.156	Tinggi
2	Pastri (Kek, Tart, Pai, Roti Kuih-Muih & Lain-Lain)	3.78	1.162	Tinggi
3	Bioteknologi Pertanian	3.12	1.128	Sederhana
4	Akuakultur (Perikanan)	2.88	1.028	Sederhana
5	Seni Kraf Tangan	3.32	2.477	Sederhana
6	Teknologi Elektrik	2.94	1.126	Sederhana
7	Pelancongan dan Pengembaraan	3.20	1.150	Sederhana
8	Teknologi Penyejukan & Penyamanan Udara	2.91	1.841	Sederhana
9	Animasi 3D	2.84	1.181	Sederhana
10	Lanskap (Pemandangan Alam sesuatu kawasan)	2.98	1.146	Sederhana
11	Kimpalan (Welding)	2.98	1.352	Sederhana
12	Automotif (Servis Kenderaan Ringan seperti motor dan kereta)	3.15	1.363	Sederhana
Keseluruhan		3.16	1.342	Sederhana

Jadual 7 menunjukkan bahawa item pengetahuan pelajar mengenai program yang mampu menyumbang kepada perkembangan kerjaya di masa hadapan berada pada tahap

sederhana. Item yang mempunyai min yang tinggi ialah Kulineri (min = 3.86 dan sp = 1.156), diikuti dengan item Pastrri (min = 3.78 dan sp = 1.162) dan item Seni Kraf Tangan (min = 3.32 dan sp = 2.477). Secara keseluruhannya menunjukkan bahawa pengetahuan pelajar mengenai program yang mampu menyumbang kepada perkembangan kerjaya di masa hadapan berada pada tahap sederhana (min = 3.16 dan sp = 1.342).

Analisis pengetahuan pelajar mengenai program yang dapat memenuhi keperluan industri di masa hadapan

Analisis deskriptif yang melibatkan min dan sisihan piawai dijalankan untuk mengenalpasti pengetahuan pelajar mengenai program yang dapat memenuhi keperluan industri di masa hadapan. Hasil analisis deskriptif seperti Jadual 8 berikut.

Jadual 8: Analisis pengetahuan pelajar mengenai program yang dapat memenuhi keperluan industri di masa hadapan

No	Item	Min	Sisihan Piawai	Interpretasi
1	Kulineri (Masakan)	3.87	1.194	Tinggi
2	Pastrri (Kek, Tart, Pai, Roti Kuih-Muih & Lain-Lain)	3.83	1.158	Tinggi
3	Bioteknologi Pertanian	3.34	1.206	Sederhana
4	Akuakultur (Perikanan)	3.08	1.120	Sederhana
5	Seni Kraf Tangan	3.23	1.007	Sederhana
6	Teknologi Elektrik	3.14	1.139	Sederhana
7	Pelancongan dan Pengembaraan	3.36	1.139	Sederhana
8	Teknologi Penyejukan & Penyamanan Udara	3.07	1.191	Sederhana
9	Animasi 3D	3.04	1.211	Sederhana
10	Lanskap (Pemandangan Alam sesuatu kawasan)	3.14	1.188	Sederhana
11	Kimpalan (Welding)	3.16	1.335	Sederhana
12	Automotif (Servis Kenderaan Ringan seperti motor dan kereta)	3.35	1.378	Sederhana
Keseluruhan		3.30	1.188	Sederhana

Jadual 8 menunjukkan bahawa item pengetahuan pelajar mengenai program yang dapat memenuhi keperluan industri di masa hadapan berada pada tahap sederhana. Item yang mempunyai min yang tinggi ialah Kulineri (min = 3.87 dan sp = 1.194), diikuti dengan item Pastrri (min = 3.83 dan sp = 1.158) dan item Pelancongan dan Pengembaraan (min = 3.36 dan sp = 1.139). Secara keseluruhannya, analisis menunjukkan bahawa pengetahuan pelajar mengenai program yang dapat memenuhi keperluan industri di masa hadapan berada pada tahap sederhana (min = 3.30 dan sp = 1.188).

Analisis program baharu yang sesuai ditawarkan di Kolej Komuniti Lipis

Analisis deskriptif yang melibatkan min dan sisihan piawai dijalankan untuk menentukan program baharu yang sesuai ditawarkan di Kolej Komuniti Lipis. Hasil analisis deskriptif seperti Jadual 9 berikut.

Jadual 9: Analisis program baharu yang sesuai ditawarkan di Kolej Komuniti Lipis

No	Item	Min	Sisihan Piawai	Interpretasi
1	Kulinari (Masakan)	4.08	1.186	Tinggi
2	Pastri (Kek, Tart, Pai, Roti Kuih-Muih & Lain-Lain)	4.07	1.129	Tinggi
3	Bioteknologi Pertanian	3.38	1.262	Sederhana
4	Akuakultur (Perikanan)	3.15	1.227	Sederhana
5	Seni Kraf Tangan	3.37	1.204	Sederhana
6	Teknologi Elektrik	3.33	1.209	Sederhana
7	Pelancongan dan Pengembaraan	3.38	1.196	Sederhana
8	Teknologi Penyejukan & Penyamanan Udara	3.11	1.211	Sederhana
9	Animasi 3D	3.05	1.277	Sederhana
10	Lanskap (Pemandangan Alam sesuatu kawasan)	3.22	1.206	Sederhana
11	Kimpalan (Welding)	3.34	1.284	Sederhana
12	Automotif (Servis Kenderaan Ringan seperti motor dan kereta)	3.56	1.315	Sederhana
Keseluruhan		3.42	1.225	Sederhana

Jadual 9 menunjukkan bahawa item program baharu yang sesuai ditawarkan di Kolej Komuniti Lipis berada pada tahap sederhana. Item yang mempunyai min yang tinggi ialah Kulinari (min = 4.08 dan sp = 1.186), diikuti dengan item Pastri (min = 4.07 dan sp = 1.129) dan item Automotif (min = 3.56 dan sp = 1.315). Secara keseluruhannya, analisis menunjukkan bahawa program baharu yang sesuai ditawarkan di Kolej Komuniti Lipis berada pada tahap sederhana (min = 3.42 dan sp = 1.225).

PERBINCANGAN

Analisis deskriptif dalam kajian ini yang melibatkan yang melibatkan min dan sisihan piawai menunjukkan bahawa pada item pengetahuan para pelajar mengenai bidang yang wujud di Malaysia berada tahap rendah, item minat para pelajar terhadap program yang ditawarkan juga berada tahap sederhana, item pengetahuan pelajar mengenai program yang mampu menyumbang kepada perkembangan kerjaya di masa hadapan juga pada tahap sederhana, item pengetahuan pelajar mengenai program yang dapat memenuhi keperluan industri di masa hadapan pada tahap sederhana dan item program baharu yang ditawarkan di Kolej Komuniti Lipis adalah Program Kulinari yang menduduki tempat tertinggi diikuti dengan Program Pastri dan Program Automotif.

Hal ini menunjukkan bahawa tahap kefahaman dan kesedaran pelajar-pelajar sekolah menengah harian di Daerah Lipis adalah pada tahap sederhana mengenai beberapa program yang boleh menjamin masa hadapan dan bersesuaian dengan keperluan industri. Oleh itu, cadangan kursus baharu ini diharapkan mendapat pertimbangan daripada pihak yang berkenaan demi kepentingan para pelajar sekolah menengah harian di Daerah Lipis secara khasnya dan masyarakat di Daerah Lipis secara amnya.

KESIMPULAN

Hasil kajian mendapati bahawa terdapat tiga cadangan program baharu yang mendapat tempat tertinggi dalam dapatan melalui borang soal selidik iaitu Program Kulinari, Program Pastrri dan Program Automotif mengikut pandangan para pelajar sekolah menengah harian di Daerah Lipis. Sehubungan itu, penulis amat berharap bahawa tiga cadangan ini dipertimbangkan dengan sewajarnya daripada pihak yang berkaitan supaya para pelajar sekolah menengah harian dan juga masyarakat di Daerah Lipis mendapat satu program baharu yang memenuhi minat mereka juga sesuai dengan pasaran kerja masa kini.

RUJUKAN

- Azurin Jaafar. (2003). Tinjauan Tahap Pengetahuan Pelajar Semester Satu Diploma Pengurusan Pelancongan Mengenai Kursus Diploma Pengurusan Pelancongan di Politeknik Johor Bahru. Tesis Ijazah Saijana Pendidikan Teknik dan Vokasional: Kolej Universiti Teknologi Tun Hussien Onn.
- Buku Panduan penyediaan program siswazah baharu.* (2017). Serdang: Universiti putra Malaysia.
- Kamalularifin Subari, Ibnatul Jalilah Yusof & Aminah Ahmad. (2020). Kajian Awal: Tahap Penguasaan Pelajar Kolej Komuniti Dalam Konsep Elektrik Menggunakan Pendekatan Model Pengukuran Rasch. *Jurnal Persatuan Pendidikan Teknik Dan Vokasional Malaysia*. Jilid 9/ Volume 9 . Julai 2020/ July 2020
- M. H. Norhidayah, H.Y. Ahmad Mujahideen & W. S. W. A. Najmuddin. (2017). Faktor-Faktor Pendorong Pemilihan Kursus Di Institusi Pengajian Tinggi- Satu Ulasan. *Journal of Humanities, Language, Culture and Business (HLCB)* Vol. 1: No. 5 (September 2017).
- Muhammad Jeffery Hizwan Bin Said. (2018). Kertas Cadangan Penyelidikan (Sarjana Muda) Tahap Sikap Kerja Dan Hubungannya dengan Prestasi Kerja Pekerja : Kajian Di Syarikat Triple A. diperoleh dari https://www.researchgate.net/publication_pada_22_April_2021.
- Noor Suhaila Yusof & Kamal Izzuwan Ramli. (2006). Persepsi Pelajar Terhadap Peluang Kerjaya dalam Bidang Pelancongan. Diperoleh dari eprints.utm.my pada 5 Mei 2021.
- Pelan Strategik Politeknik dan Kolej Komuniti (2018-2025). Diperoleh dari <https://www.mypolycc.edu.my/index.php/muat-turun/penerbitan/download/2-penerbitan/5-psjppkk> pada 16 April 2021
- Sarimah Che Hassan, Armanurah Mahamad & Amir Md Noor. (2013). Potensi Kolej Komuniti Sebagai Wadah Pembentukan ‘Majikan’ Lestari. *Prosiding Persidangan Kebangsaan Ekonomi Malaysia Ke VIII 2013*.
- Siti Hamisah Tapsir. (2019). Struktur semula pengajaran dan pembelajaran UA. Diperoleh dari <https://www.bharian.com.my/berita/pendidikan/2019/09/610225/struktur-semula-pengajaran-dan-pembelajaran-ua> pada 21 April 2021.
- Wan Mohd Zul Bin Wan Yusuf, Azizah Binti Mohamed & Mohd Ridzuan Bin Abdul Rashid. (2019). *Kajian Penawaran Program Baharu Di Kolej Komuniti Lipis Dalam Kalangan Penduduk Daerah Lipis, Pahang*. Kolej Komuniti Lipis: Pahang.

Study on the Perceptions and Health Policies Related to the Implementation, Protection, and Fulfillment of the Rights of Persons with Disabilities in Indonesia

Ulfa Ulinnuha

Universitas Nahdlatul Ulama Surabaya
ulfaulinnuha@outlook.com

Atik Qurrota A'Yunin Al Isyofi

Universitas Nahdlatul Ulama Surabaya
atikqurrotaa@unusa.ac.id

Mursyidul Ibad

Universitas Nahdlatul Ulama Surabaya
mursyidul.ibad@unusa.ac.id

ABSTRAK

Pandangan individu terhadap orang disabilitas masih sangat pelbagai. Ramai orang masih menganggap orang disabilitas sebagai kumpulan yang tidak diinginkan. Ini memburukkan lagi kemudahan akses untuk orang disabilitas kerana mereka tidak terlibat secara aktif dalam aktiviti kesihatan. Artikel ini bertujuan untuk menganalisis persepsi dan dasar orang ramai mengenai orang disabilitas sebagai usaha menyokong pelaksanaan, perlindungan dan pemenuhan hak orang disabilitas, terutamanya dalam sektor kesihatan. Artikel ini menggunakan tinjauan literatur untuk menganalisis persepsi orang ramai dan kebijakan kerajaan mengenai orang disabilitas. Data yang digunakan adalah data sekunder. Kajian ini menggunakan kaedah kajian tinjauan tradisional untuk menerangkan topik utama. Hasil kajian menunjukkan bahawa persepsi masyarakat dan pembuat kebijakan terhadap orang disabilitas masih negatif. Persepsi dan kebijakan kerajaan terhadap orang disabilitas berkait rapat dengan usaha untuk menyokong akses kesihatan orang disabilitas. Pelaksanaan Undang-undang Republik Indonesia No. 8 Tahun 2016 tentang orang Disabilitas masih belum optimal. Beberapa wilayah belum mempunyai peraturan terbitan yang mengawal pelaksanaan, perlindungan, dan pemenuhan hak orang disabilitas. Pembuat kebijakan masih menganggap bahawa pemenuhan hak orang disabilitas bukanlah tanggungjawab bersama. Manakala orang disabilitas memerlukan kebijakan yang komprehensif dan pro terhadap pelaksanaan, perlindungan dan pemenuhan hak mereka. Ini disebabkan oleh persepsi negatif terhadap orang disabilitas. Oleh itu, peranan kerajaan diharapkan dalam memenuhi hak orang disabilitas melalui kebijakan yang boleh mengubah persepsi rakyat terhadap orang disabilitas. Masyarakat juga diharapkan dapat membantu kerajaan dalam melaksanakan kebijakan atas orang disabilitas bagi meningkatkan kebolehcapaian orang disabilitas dalam sektor kesihatan.

Kata kunci: *fasilitas kesehatan; pelaksanaan; perlindungan; pemenuhan; hak orang disabilitas*

ABSTRACT

Individual views of persons with disabilities are still wildly varied. A lot of people still consider persons with disabilities as an unwanted group. This worsens the ease of accessibility of the group because they are not actively involved in health activities. The purpose of this article is to analyze public perceptions and government policies to support the implementation, protection, and fulfillment of the rights of persons with disabilities, especially in healthcare sector. Authors analyze the topic using a literature review method with secondary data and

follows the traditional review methods to describe it. The conclusion of this article shows the still negative perception of the group within the community and policymakers alike. The government's perceptions and policies towards the group are closely related with the efforts to support the healthcare accessibility of persons with disabilities. The lack of implementation of the Law of the Republic of Indonesia No. 8 of 2016 concerning persons with disabilities, and the lack of existence of derivative policies in lower municipalities added more to the concern. Policymakers still consider that the fulfillment of the rights of persons with disabilities as the responsibility of just a department. Whereas persons with disabilities need comprehensive policies that aim towards the implementation, protection, and fulfillment of their rights especially in healthcare. This shall be done by placing policies that could influence the majority's perceptions about persons with disabilities. The community is also expected to support the government's effort in the implementation to improve healthcare accessibility of persons with disabilities.

Keywords: *healthcare; implementation; protection; fulfillment; persons with disabilities rights*

INTRODUCTION

Based of the Law of the Republic of Indonesia No. 8 of 2016, a person is referred to as a person with a disability when he or she has physical, intellectual, mental, and/or sensory limitations (Indonesia, 2016). Based on current data for 2020 disability from the Central Bureau of Statistics (BPS), the number of people with disabilities in Indonesia reaches 22.5 million or around five percents (BPS, 2021). People with disabilities generally have limited access to health services (WHO, 2021). In addition, public service facilities, including health service facilities, have not optimally realized equal opportunity for rights in accessing services between persons with disabilities and other communities. In fact, some evidence shows that on average people with disabilities have worse health conditions (Aktariyani et al., 2020). Most of the people with disabilities in Indonesia live in vulnerable, backward, and/or poor conditions due to the existence of restrictions, obstacles, difficulties, and reduction or elimination of the rights of persons with disabilities. Stigma, prejudice, and denial of access to health services, education, employment, and participation in society put people with disabilities at risk of living in poverty (WHO & UNFPA, 2009).

The equal rights of persons with disabilities have been regulated in Law No. 8 of 2016. One of the rights of persons with disabilities as stated in the law is to receive the same facilities and health care, for example in the case of participation in the Social Security Administering Body (BPJS). Although the participation of persons with disabilities is fully paid for by the government, there are other contexts that need to be considered. The situation of Indonesia, which has 34 provinces with varying fiscal, geographic and regional health system governance capacities, makes it possible for certain groups such as people with chronic diseases and persons with disabilities to have limited access to health services. For example the need for health services that are not covered in the benefits package, or accommodation. In order to reduce the gap in the rights to health services for persons with disabilities, a proposal that needs to be considered immediately is that the central and local governments need to issue legislation which is a mandate in the Law on Persons with Disabilities (2016), which until now does not exist, such as the regulation on referral of patients with disabilities. disability; regulation of health service standards for persons with disabilities in various health facilities; regulations regarding indicators of health facilities that are easy and responsive for persons with disabilities; and regulations/guidelines regarding competence and training of health workers in providing health services for persons with disabilities (Aktariyani et al., 2020).

Indonesia is a country with the number 125 inclusivity in the world. Among ASEAN countries, Indonesia's ranking is still below the Philippines, Vietnam, Singapore, and Thailand (Yulaswati et al., 2021). The lack of equitable implementation of Law no. 8 of 2016 is one of the causes of many people with disabilities who are less prosperous. This causes a lack of public understanding of the urgency of the rights of persons with disabilities. In addition, the impact of the lack of equitable distribution of policies in Law No. 8 of 2016 in the health sector is that there are no Permenkes that regulate persons with disabilities (Yulaswati et al., 2021). Ownership of the National Health Insurance (JKN) for persons with disabilities is also still low (Yulaswati et al., 2021), and health regulations for referrals and assistive devices are still ambiguous and not clearly defined in the law (Aktariyani et al., 2020).

Several provinces in Indonesia do not yet have specific regulations regarding the implementation, protection, and fulfillment of the rights of persons with disabilities. Provinces in which all districts or cities have a Regional Regulation (Perda) on the rights of persons with disabilities, the new D.I. Yogyakarta and Jakarta. Meanwhile, those that achieved more than 50% were only districts/cities in the Provinces of Bali and Central Java. The rest is still below 50% (Yulaswati et al., 2021). The reason for the lack of local regulations governing health policies related to the implementation, protection, and fulfillment of the rights of persons with disabilities is that policymakers do not understand Law no. 8 of 2016 and limited access to facilities and infrastructure.

Based on this background, the researcher wants to know more about perceptions and health policies related to implementing, protecting, and fulfilling the rights of persons with disabilities. The results of this study are expected to provide an overview of perceptions and health policies related to the implementation, protection, and fulfillment of the rights of persons with disabilities in Indonesia.

HEALTH POLICY REGARDING THE IMPLEMENTATION, PROTECTION AND FULFILLMENT OF THE RIGHTS OF PEOPLE WITH DISABILITIES IN INDONESIA

Based on the article search process, the findings of articles have been obtained that have been processed through the suitability of health policy studies related to the implementation, protection, and fulfillment of the rights of persons with disabilities in Indonesia.

Table 34. Health Policy Study Related to Implementation, Protection, and Fulfillment of Rights of Persons with Disabilities in Indonesia.

No.	Writers and Year	Results of the Implementation of Health Policies Related to the Implementation, Protection, and Fulfillment of the Rights of Persons with Disabilities in Indonesia
1.	Syukria & Supriyanto, 2016	Access for children with disabilities to the Gubeng Health Center and the Mulyorejo Health Center is still low compared to other health services. Children with disabilities who come to the Puskesmas are children with low family incomes and have relatively low health and transportation costs.
2.	Agustina, 2018	The fulfillment of rights of persons with disabilities, especially in health, can be fulfilled through Posbindu. However, there are still some problems, namely the loss of community empowerment issues with health and social insurance issues, the need to make promotive and preventive

No.	Writers and Year	Results of the Implementation of Health Policies Related to the Implementation, Protection, and Fulfillment of the Rights of Persons with Disabilities in Indonesia
		the main program in the community health efforts of the puskesmas, there is no support, guidance, and supervision from the puskesmas and the health office, the making of evaluation guidelines has not involved all relevant stakeholders.
3.	Utami, 2019	Indonesia has a high level of disability compared to other Southeast Asian regions. Various policy and legal steps to protect disability have been carried out by Indonesia. In Southeast Asia, Indonesia, the Philippines, and Singapore are the countries that have signed or ratified the International Convention on the Rights of Persons with Disabilities, while Myanmar and Vietnam are the countries that have signed or ratified the convention the least.
4.	Rahmi et al., 2019	In the implementation of the BPJS Health policy for people with disabilities, it can be seen that there is no policy that specializes for people with disabilities to get access to health that is specifically for their health needs. However, in the regulations that guide the implementation of BPJS, there are regulations that discuss medical devices that can be covered by BPJS fees, in which there are several needs for medical devices needed by persons with disabilities.
5.	Andriani, 2020	Equal rights to treatment have not been implemented. Some patients are refused by the hospital to receive Covid-19 treatment.
6.	Aktariyani et al., 2020	Discussion on the rights of persons with disabilities in Law no. 8 of 2016 is still too general. Specific regulations that do not yet exist, namely regarding referrals of patients with disabilities; regulation of health service standards for persons with disabilities in various health facilities; regulations on indicators of health facilities that are easy and responsive for persons with disabilities; and regulations/guidelines regarding the competence and training of health workers in providing health services for persons with disabilities.
7.	Hasibuan & Ayuningtyas, 2021	Puskesmas as level 1 health facilities are very close to the community. However, there are only 3 disability-friendly health centers, including Lingsar Health Center, West Lombok Regency, Lendah 1 Health Center, Kulon Progo Regency, and Salam Health Center, Bandung Wetan District, Bandung City. So far, there are no regulations regarding disability-friendly health centers. There is also no assessment of disability-friendly health centers.
8.	Yulaswati et al., 2021	Provinces in which all districts or cities have a Regional Regulation (Perda) on the rights of persons with disabilities, the new D.I. Yogyakarta and Jakarta. Meanwhile, those that achieved more than 50% were only districts/cities in the Provinces of Bali and Central Java. The rest is still below 50%.

Search results for articles related to the implementation of Law no. 8 of 2016 in the health sector show that the implementation has not been maximized. There are not many levels I health facilities that are very close to the community that is disability friendly, and there are only three Disability Friendly Health Centers in Indonesia (Hasibuan & Ayuningtyas, 2021). This is in line with previous research which explains that Puskesmas services for persons with disabilities are still lacking. The causes are various, ranging from the lack of transportation accessibility, the long distance, and to the cost of transportation (Syukria & Supriyanto, 2016). Not only accessibility is lacking, but discrimination and rejection of patients with disabilities also occur. This is explained by the reason that the hospital services do not serve patients with disabilities (Andriani, 2020). In reaching and improving the health of persons with disabilities, Posbindu is considered quite effective. Because health workers go directly to the community and conduct home visits for people with disabilities who have multiple limitations (Agustina, 2018). However, the obstacles are the lack of need to make promotive and preventive the main program in public health efforts at the puskesmas, the lack of support, guidance, and supervision from the puskesmas and the health office, the making of evaluation guidelines have not involved all relevant stakeholders.

One of Indonesia's efforts to involve people with disabilities is the ratification of the United Nations Convention on the Rights of Persons with Disabilities (UNCRPD) through Law No. 19 of 2011 concerning the Ratification of the Convention on the Rights of Persons with Disabilities. United Nations Convention on the Rights of Persons with Disabilities (UNCRPD, 2007) is very unique because it contains human rights and development policy instruments. The Convention is cross-disabled, cross-sectoral, and legally binding. It aims to promote, protect and ensure that persons with disabilities can fully and equally enjoy all human rights and fundamental freedoms and promote respect for their dignity and worth. The Convention marks a “paradigm shift” in behavior and approaches towards persons with disabilities. Persons with disabilities are not seen as objects of charity, medical treatment, and social protection, but are seen as human beings who have rights who can obtain these rights and make decisions about their lives according to the wishes and permissions they give them like other members of society (Utami, 2019).

However, its implementation is still not optimal. Even in the implementation of the BPJS Health policy for people with disabilities, it can be seen that there is no policy that specializes for people with disabilities to get access to health that is specifically for their health needs (Rahmi et al., 2019). The ownership of the National Health Insurance (JKN) or private insurance by persons with disabilities is still diverse. Bali, West Kalimantan, Lampung and South Kalimantan have been the provinces with the highest insurance penetration rates for persons with disabilities in the last three years. Meanwhile, based on the level of ownership, on average 2 to 3 out of 10 persons with disabilities still do not have health insurance. Jambi, NTB, and Maluku provinces are the 3 provinces with the least ownership of health insurance for persons with disabilities relative to the population with disabilities, while the provinces of Aceh, DKI, and Papua are the areas with the highest health insurance ownership relative to the population of persons with disabilities (Yulaswati et al., 2021).

If viewed from the derivative regulations, not many regions have Regional Regulations (Perda). Provinces in which all districts or cities have a Regional Regulation (Perda) on the rights of persons with disabilities, the new D.I. Yogyakarta and Jakarta. Meanwhile, those that achieved more than 50% were only districts/cities in the Provinces of Bali and Central Java. The rest is still below 50% (Yulaswati et al., 2021). In addition, there is no Ministry of Health

Regulation (Permenkes) which is the leading actor in Government Regulations that is used as a reference to improve the implementation, protection, and fulfillment of the rights of persons with disabilities in the health sector in Indonesia (Yulaswati et al., 2021). This has an impact on health services for persons with disabilities. Specific regulations that do not yet exist, namely regarding referrals of patients with disabilities; regulation of health service standards for persons with disabilities in various health facilities; regulations on indicators of health facilities that are easy and responsive for persons with disabilities; and regulations/guidelines regarding the competence and training of health workers in providing health services for persons with disabilities (Aktariyani et al., 2020).

COMMUNITY PERCEPTIONS REGARDING THE IMPLEMENTATION, PROTECTION, AND FULFILLMENT OF THE RIGHTS OF PEOPLE WITH DISABILITIES IN INDONESIA

Based on the article search process, the results of the article findings have been obtained that have been processed through the suitability of the study of Public Perceptions on the Health of Persons with Disabilities in Indonesia.

Table 35 Study of Public Perception on Health of Persons with Disabilities in Indonesia.

No.	Writers and Year	Study of Public Perception on Health of Persons with Disabilities in Indonesia
1.	Rimmer & Rowland, 2008	It is important for health professionals and healthcare providers to identify personal and environmental factors that can hinder or increase participation in health promotion among persons with disabilities. Health workers should also be aware of the possible barriers faced by persons with disabilities. So that when these obstacles can be overcome, people with disabilities can access health promotion services easily. Health promotion for persons with disabilities must be consistent with two things, namely empowerment to manage their health and providing disability-friendly health promotion such as providing a health promotion environment with easy accessibility both at home, at work, and in organizations. Health promotion has become an important goal in public health and public policy, and reducing health disparities among persons with disabilities should be an important part of health promotion.
2.	WHO, 2010	The Community-Based Rehabilitation Guidelines (RBM) aim to improve the welfare of persons with disabilities, especially in the health sector. There is a perception that is formed in the community, making it difficult for people with disabilities to be able to access health services. So that the existence of community-based RBM guidelines is expected to reduce the stigma against persons with disabilities through education, empowerment, and increasing social equality.
3.	Huber et al., 2011	The proposed new definition of health is “healthy” as the ability to adapt and manage oneself. It builds a new

No.	Writers and Year	Study of Public Perception on Health of Persons with Disabilities in Indonesia
		concept in human health with dynamic features and capabilities that can be measured and can be applied to people with disabilities.
4.	Dini Widinarsih, 2019	The term persons with disabilities continue to evolve. The mention of the term can also affect a person's view of something. One of the causes of the emergence of the concept of normality in society is because the terms that are often used for persons with disabilities are disabled, children with special needs, and disabled. The old term forms the public perception that people with disabilities are “abnormal” people because their bodies and/or mental conditions are not like “normal” people. So that it creates discrimination against persons with disabilities.
5.	Andriani, 2020	The health perspective views disability as caused solely by an abnormal body condition due to an impairment (damage or abnormality). However, the social perspective shows that people with disabilities become "disabled" not for medical reasons but because of the community's perspective. The physical damage or disability they have defines them in society. This perspective then leads to marginalization and discrimination against persons with disabilities.
6.	Yulaswati et al., 2021	Despite the development of the term, there are still some local regulations that still use the term disability and special needs. The uniformity is needed solely to avoid various interpretations in understanding a formulation in the legislation, and to make it easier to understand and implement the regulation.

If a person is born with a congenital disability then that individual is not considered a good candidate for a health promotion program, because the purpose of health promotion is to prevent disease, not to treat the "ill" or "disabled". (WHO, 2010). Based on this definition, there is a need for a new formula in the definition of health. Redefining health is an ambitious and complex goal. Many aspects need to be considered such as renegotiation by policymakers, and reflection of many cultures, and also must take into account the flexibility to the development of science and technology in the future. The results of the discussion of experts at the Dutch conference gave rise to widespread support for moving from the current static formulation of the definition to a more dynamic one based on resilience or capacity to cope and maintain and restore integrity, balance, and a sense of well-being. Discussions from these experts also resulted in a new preferred view of health, namely the "ability to" adapt and manage oneself (Huber et al., 2011).

Measuring these “capacities” can be helped by building a health framework that adapts operational needs to suit individual health conditions. For example, by distinguishing health status between individuals and populations and between objective and subjective indicators of health. The measurement instrument should be in line with the definition of health as the ability to adapt and manage oneself. This is a good first operation including existing methods for

assessing the functional status and measuring the quality of life and sense of well-being. WHO has developed several disability classification systems that measure health gradations that assess aspects such as disability, function, quality of life, and perceived well-being (Huber et al., 2011).

The initial assumption that people with disabilities are sick people is following the concept of normality in society which creates a negative understanding of disability in society. This negative understanding is mostly dominated by the concept of normality where people who have different body shapes or behaviors are considered undesirable and cannot be accepted as part of the community (Widinarsih, 2019). Words, terms, or definitions can also shape people's attitudes and behavior. As defined by WHO, health is a state of complete physical, mental and social well-being and not merely the absence of disease or infirmity. This definition is not in line with the condition of persons with disabilities and creates a general perception of health and illness where health is often defined as the absence of disease or disability so that people with disabilities are not included in the target of ease of accessibility. (Huber, et al., 2011).

METHOD

This study uses a literature review method. The literature review was carried out using secondary data consisting of several sources such as books, national and international journals, and other internet sources regarding the study of health perceptions and policies related to the implementation, protection, and fulfillment of the rights of persons with disabilities in Indonesia. The data search process was determined by the following inclusion criteria; (1) Open access to research articles from accredited journals and full text; (2) Books on policy regulations on the rights of persons with disabilities in Indonesia (3) Access to news sourced from clear publishers.

REFERENCES

- Agustina, S. C. (2018). *Peran posbindu disabilitas dalam pemenuhan hak penyandang disabilitas*. 7.
- Aktariyani, T., Marthias, T., & Trisnantoro, L. (2020). *POTRET : Pemenuhan Akses Pelayanan Kesehatan bagi Penyandang Disabilitas era JKN*.
- Andriani, I. (2020). Diskriminasi Hak atas Perawatan Kesehatan bagi Penyandang Disabilitas. *Universitas Diponegoro*. <http://krdfhundip.com/wp-content/uploads/2020/12/DISKRIMINASI-HAK-ATAS-PERAWATAN-KESEHATAN-BAGI-PENYANDANG-DISABILITAS.pdf>
- BPS. (2021). *Hari Disabilitas Internasional*. Badan Pusat Statistik. <https://talaudkab.bps.go.id/news/2021/12/03/74/hari-disabilitas-internasional.html>
- Dini Widinarsih. (2019). Penyandang Disabilitas Di Indonesia: Perkembangan Istilah Dan Definisi. *Jurnal Kesejahteraan Sosial*, 20, 127–142.
- Hasibuan, S. U., & Ayuningtyas, D. (2021). A Literature Review: Gambaran Perwujudan Puskesmas Ramah Disabilitas pada Beberapa Wilayah di Indonesia. *Jurnal Medika Hutama*, 3(1), 1390–1399. <http://jurnalmedikahutama.com>
- Huber, M., André Knottnerus, J., Green, L., Van Der Horst, H., Jadad, A. R., Kromhout, D., Leonard, B., Lorig, K., Loureiro, M. I., Van Der Meer, J. W. M., Schnabel, P., Smith, R., Van Weel, C., & Smid, H. (2011). How should we define health? *BMJ (Online)*, 343(7817). <https://doi.org/10.1136/bmj.d4163>
- Indonesia, P. (2016). *UU Republik Indonesia Nomor 8 Tahun 2016 tentang Penyandang*

- Disabilitas*. https://pug-pupr.pu.go.id/_uploads/PP/UU.No.8.Th.2016.pdf
- Rahmi, M., Apsari, N. C., & Ishartono, I. (2019). Pelaksanaan Asuransi Kesehatan Khusus Bagi Penyandang Disabilitas. *Focus : Jurnal Pekerjaan Sosial*, 1(3), 183. <https://doi.org/10.24198/focus.v1i3.20495>
- Rimmer, J. H., & Rowland, J. L. (2008). Health Promotion for People With Disabilities: Implications for Empowering the Person and Promoting Disability-Friendly Environments. *American Journal of Lifestyle Medicine*, 2(5), 409–420. <https://doi.org/10.1177/1559827608317397>
- Syukria, O. A., & Supriyanto, S. (2016). DETERMINAN PEMANFAATAN PUSKESMAS PADA ANAK PENYANDANG DISABILITAS. *Jurnal Administrasi Kesehatan Indonesia*, 4, 37–48.
- Utami, W. K. (2019). STUDI PERBANDINGAN PERLINDUNGAN HAK PENYANDANG DISABILITAS DI INDONESIA DAN WILAYAH ASIA TENGGARA. *Jurnal Polinter*, 4(2), 1–13.
- WHO. (2010). *Rehabilitasi Bersumberdaya Masyarakat: Pedoman RBM*. World Health Organization.
- WHO. (2021). *Disability and health*. WHO. <https://www.who.int/en/news-room/fact-sheets/detail/disability-and-health>
- WHO, & UNFPA. (2009). Promoting Sexual and Reproductive Health for Persons with Disabilities: WHO/UNFPA Guidance Note. In *Physics Letters B* (Vol. 72, Issue 3). WHO/UNFPA. [https://doi.org/10.1016/0370-2693\(78\)90137-5](https://doi.org/10.1016/0370-2693(78)90137-5)
- Yulaswati, V., Nursyamsi, F., Ramadhan, M. N., Palani, H., & Yazid, E. K. (2021). *TINJAUAN PENINGKATAN AKSES DAN TARAF HIDUP PENYANDANG DISABILITAS INDONESIA : ASPEK SOSIOEKONOMI DAN YURIDIS* (V. Yulaswati (ed.)). Staf Ahli Menteri Bidang Sosial dan Penanggulangan Kemiskinan, Kementerian PPN/Bappenas.

Isu dan Cabaran Kerja Masyarakat Kerinci: Kajian Kes di Lembah Pantai Kuala Lumpur

Sharmin Kutty Sivaraman
Lincoln University College
sharmin@lincoln.edu.my

Khairul Izzat Amirudin
University of Malaya
Izzatamiruddin92@gmail.com

Adib Zakwan Al Qayyum
University of Malaya
fazaq94@gmail.com

Sutharssan Nadarajan
University Kebangsaan Malaysia
SutharssanNadarajan@gmail.com

ABSTRACT

Work issues and challenges are what everyone will face. When a person faces work issues and challenges, the quality of work can be affected and able to affect oneself for a long time. Hence, this study discusses the issues and challenges of the work of the Kerinci community in Pantai Dalam, Kuala Lumpur. The purpose of this study is to identify and analyze the work issues and challenges facing the Kerinci community as well as to compare the issues and challenges of work towards the community. The findings found that among the work issues and challenges faced by the Kerinci community include discrimination, workplace problems, psychological problems, and being deceived by employers. Therefore, the issues and challenges of the work of the Kerinci community are matters that need to be addressed by all parties immediately as the Kerinci community also needs to obtain their rights as workers.

Keywords: *the Kerinci race, migration, jobs, issues and challenges, Coast Valley.*

ABSTRAK

Isu dan cabaran kerja merupakan perkara yang akan dihadapi oleh semua orang. Apabila seseorang itu menghadapi isu dan cabaran kerja, maka kualiti kerja boleh terjejas dan mampu memberi kesan kepada diri untuk jangka masa yang panjang. Justeru kajian ini membincangkan mengenai isu dan cabaran kerja masyarakat Kerinci di Pantai Dalam, Kuala Lumpur. Kajian ini akan menggunakan kaedah kualitatif untuk mendapatkan data temu bual daripada responden. Tujuan kajian ini dilakukan adalah untuk mengenal pasti dan menganalisis isu dan cabaran kerja yang dihadapi masyarakat Kerinci serta membandingkan isu dan cabaran kerja terhadap masyarakat tersebut. Hasil kajian mendapati bahawa antara isu dan cabaran kerja yang dihadapi oleh masyarakat Kerinci termasuklah diskriminasi, masalah di tempat kerja, masalah psikologi, dan ditipu majikan. Justeru, isu dan cabaran kerja masyarakat Kerinci merupakan perkara yang perlu ditangani oleh semua pihak dengan segera kerana masyarakat Kerinci juga perlu mendapatkan hak-hak mereka sebagai pekerja.

Kata kunci: *kaum Kerinci, penghijrahan, pekerjaan, isu dan cabaran, Lembah Pantai.*

PENGENALAN

Rakyat Malaysia dihuni oleh masyarakat yang pelbagai kaum. Menurut Kementerian Sumber Manusia, pada tahun 2019, jumlah penduduk Malaysia adalah seramai 32.4 juta sehingga bulan Mac. Mengikut jantina pula, 16.7 juta merupakan lelaki dan selebihnya merupakan perempuan. Daripada keseluruhan statistik yang telah dinyatakan tadi, kaum Bumiputera adalah seramai 20.1 juta. Kaum bumiputera termasuk orang asli, bumiputera Sabah dan Sarawak, dan kaum Melayu. Menurut Kementerian Sumber Manusia juga, warganegara Malaysia yang bekerja adalah seramai 12,214.6 juta orang. Industri pekerjaan yang wujud dalam statistik kementerian adalah pertanian, perikanan dan perhutanan, perlombongan dan pengkuarian, pembuatan, pembinaan, dan perkhidmatan.

Sebagaimana diketahui, pelbagai isu akan dihadapi oleh masyarakat yang berhijrah dari sesebuah negara. Antara isu yang dapat dikatakan ialah isu pendidikan, pekerjaan, sosial dan sebagainya. Isu sebegini secara tidak langsung akan memberikan satu kesan yang kurang memberangsangkan kepada pembangunan di kawasan tersebut. Selain itu, pelbagai rintangan dan cabaran perlu ditempuhi oleh masyarakat tersebut seperti cabaran kos sara hidup yang tinggi, cabaran penghijrahan yang berlaku antara luar bandar ke bandar dan sebagainya. Sebagai rakyat Malaysia, kaum Kerinci juga menghadapi isu dan cabarannya dalam dunia pekerjaan mereka di Malaysia.

Kaum Kerinci yang berasal dari daerah Kerinci di Jambi, Indonesia merupakan kaum Melayu. Ada antara mereka telah membuka penempatan baharu di Tanah Melayu, iaitu sebelum Malaysia merdeka. Kaum ini telah membuka penempatan awal di Kuala Lumpur. Menurut Abdul Hakam Jamaludin (2001) dalam penulisan beliau, daripada pembacaan latihan ilmiah di Pusat Pengajian Sejarah, Univeristi Kebangsaan Malaysia, Kampung Kerinci dibuka sewaktu penghijrahan masyarakat Kerinci ke Tanah Melayu kerana kesukaran mendapat pekerjaan di tempat asal mereka. Antaranya individu yang banyak membantu sewaktu pembukaan Kampung Kerinci ialah Haji Abdullah Ahmad. Oleh kerana ketokohan dan sumbangan beliau membantu masyarakat di Kampung Kerinci, beliau telah dijadikan tokoh oleh masyarakat tempatan dan diiktiraf sebagai perintis semasa proses penempatan kaum ini di Kampung Kerinci pada abad ke-19. Selain itu, antara tokoh Kerinci yang terkena ialah Haji Abdullah Hukum atau dikenali dengan nama asalnya Muhammad Rukun dan nama lainnya mengikut adat ialah Arya Jaya. Namun beliau kini lebih dikenali sebagai Haji Abdullah Hukum.

Kegiatan pekerjaan atau ekonomi pada awal pembukaan Kuala Lumpur banyak dikuasai oleh orang dari Tanah Jawa dan Tanah Minang (Minangkabau dan Kerinci) sebelum kedatangan imigran Cina ke Tanah Melayu. Setelah orang Cina menjadikan Kuala Lumpur sebagai hub perniagaan, persaingan pekerjaan menjadi lebih luas. Kaum Kerinci juga tidak terlepas daripada mendapatkan peluang pekerjaan dan bekerja di negara ini. Justeru, kajian yang dilakukan ini adalah untuk mengkaji isu dan cabaran kerja kaum Kerinci yang tinggal di sekitar Lembah Pantai, Kuala Lumpur.

PERMASALAHAN KAJIAN

Terdapat beberapa permasalahan kajian yang tidak diselesaikan dalam kajian ini. Oleh itu dalam kajian ini permasalahan utama ialah berkaitan ialah sejauh manakah isu dan cabaran kerja yang wujud di masyarakat Kerinci, Lembah Pantai. Sebagai manusia, isu dan cabaran pekerjaan itu tidak sama bagi setiap manusia. Oleh itu, kajian ini melihat apakah isu dan

cabaran yang wujud dalam dunia pekerjaan oleh masyarakat Kerinci. Selain itu, permasalahan kajian yang dilaksanakan ini adakah latar belakang kaum.

Permasalahan yang kedua ialah berkaitan dengan adakah latar belakang kaum Kerinci mampu mempengaruhi isu dan cabaran kerja mereka ketika bekerja di negara ini. Umum diketahui bahawa latar belakang individu atau sesebuah kelompok mampu mempengaruhi terhadap sesuatu perkara termasuk isu dan cabaran kerja mereka

Justeru, kajian ini memperlihatkan sama ada latar belakang mampu mempengaruhi isu dan cabaran kerja masyarakat Kerinci atau sebaliknya. Permasalahan yang timbul juga adakah masyarakat Kerinci mempunyai masalah yang sama atau berbeza daripada masyarakat lain dalam sektor pekerjaan mereka di negara ini.

Objektif Kajian

Setiap kajian mempunyai objektif yang tertentu iaitu:

- i. Mengenal pasti isu kerja yang dihadapi kaum Kerinci di Lembah Pantai.
- ii. Menganalisis cabaran kerja yang dihadapi kaum Kerinci di Lembah Pantai.
- iii. Membandingkan isu dan cabaran kerja yang dihadapi kaum Kerinci di Lembah Pantai

Persoalan Kajian

Bagi mencapai objektif kajian, kajian ini telah menggariskan beberapa persoalan kajian bagi menerangkan objektif kajian yang ingin dicapai. Dalam kajian ini, beberapa persoalan kajian telah dinyatakan untuk mencapai objektif yang bertepatan dengan tajuk kajian. Antara persoalan kajian telah dikenal pasti, iaitu:

- i. Apakah isu kerja yang dihadapi kaum Kerinci di Lembah Pantai?
- ii. Apakah cabaran kerja yang dihadapi kaum Kerinci di Lembah Pantai?
- iii. Apakah perbandingan isu dan cabaran kerja yang dihadapi kaum Kerinci di Lembah Pantai?

METHOD

Kajian ini akan menggunakan method kualitatif iaitu dengan menjalankan temu bual dan juga soal selidik dengan pekerja yang bekerja di sekitar kawasan Lembah Pantai, Kuala Lumpur. pengkaji menemu bual informan dengan mengajukan soalan-soalan yang bersesuaian untuk mendapatkan maklumat berkaitan isu dan cabaran informan yang bekerja di negara ini khususnya di Lembah Pantai. Temu bual atau wawancara adalah satu proses untuk mendapatkan data dengan menemui seseorang atau satu kumpulan kecil secara bersemuka serta melakukan soal jawab atau berkomunikasi dua hala yang bertujuan untuk meminta pandangan, pendapat dan pengakuan seseorang. Temu bual juga merupakan satu bentuk hubungan sosial melalui komunikasi yang mempunyai matlamat dan tujuan yang tertentu untuk mendapatkan maklumat yang berguna.

Setiap temu bual yang dilakukan bersama informan adalah bertujuan untuk mendapatkan pengakuan atau kenyataan lisan secara jujur dan benar daripada informan. Tujuan temu bual juga adalah untuk mendapatkan pengesahan dan penjelasan tentang apa yang difikirkan berlaku untuk mencapai kefahaman yang mendalam terhadap sesuatu peristiwa yang dialami oleh informan. Malahan, kaedah ini juga dapat membantu penyelidik untuk melihat situasi mengikut pandangan informan yang ditemui.

Sorotan Kajian

Appleyard.R (1992) telah melakukan kajiannya yang bertajuk “ *International Migration and Development An Unresolved Relationship*”. Penulisan ini telah menyatakan bahawa migrasi dan pembangunan merupakan satu teori dan saling berkait antara satu sama lain. Semakin banyak orang melakukan migrasi maka semakin banyak pembangunan yang sepatutnya dibuat akan menjadi lambat dan tidak dibangunkan dengan kadar yang segera. Kebanyakan penghijrah akan menggunakan pendapatan yang diperolehi untuk melangsungkan kehidupan di bandar kerana kos sara hidup di bandar ialah tinggi. Migrasi luar negara adalah dimana rakyat berpindah dari luar bandar ke bandar akan mengalami proses semakan dan jika tidak dapat menyara hidupnya di bandar akan dihantar balik ke negara asalnya.

Junipah Wandu (1995) pula melakukan kajian mengenai “*Proses Penghijrahan dan Penyesuaian di Bandar Lembah Pantai, Kerinci*”. Penulisan ini menjelaskan mengenai proses penghijrahan masyarakat dan penyesuaian mereka di Lembah Pantai, Kuala Lumpur. Proses penghijrahan ini diambil kira dengan beberapa faktor antara yang utama ialah pembangunan telah diberikan perhatian khusus dan bagaimana masyarakat yang berhijrah tersebut dapat menyesuaikan dirinya di bandar iaitu Lembah Pantai, Kerinci.

Norziah Mohamed Ali (1997) dalam kajiannya yang bertajuk “*Penghijrahan Pendatang Asing ke Malaysia: Satu Tujuan Dari Perspektif Ekonomi dan Sosio-Budaya*” telah membicarakan mengenai penghijrahan warga asing ke Malaysia. Fokus penulisan ini adalah lebih kepada bidang ekonomi dan juga sosio-budaya. Bidang ekonomi merupakan satu bidang yang sangat penting perlu diberikan penekanan yang khusus untuk pembangunan negara yang mana memberikan kebaikan kepada masyarakat di negara kita. Manakala bidang sosiobudaya merupakan satu ciri yang penting dalam pembangunan untuk mengetahui mengenai budaya sesebuah agama ataupun bangsa. Kedua-dua bidang ini merupakan faktor utama dalam penghijrahan pendatang asing dari negara mereka ke negara kita untuk meneruskan pekerjaannya demi menyara kehidupan mereka.

Muhammad Faizul Al Jaffary (2001) pula telah melaksanakan kajian yang bertajuk “*Impak Alam Sekitar Membawa Isu-isu Permasalahan Kini, Masalah Kesesakan Tempat Tinggal Lembah Pantai, Kerinci*”. Kajian ini menerangkan mengenai impak alam sekitar yang membawa kepada kesesakan tempat tinggal. Isu utama yang ditekankan ialah pembakaran terbuka dan juga pembinaan bangunan yang banyak menyebabkan tempat tinggal di Lembah Pantai menjadi padat dan menjadi padat dimana projek pembinaan untuk masa depan terpaksa ditangguhkan disebabkan kesesakan tersebut dan memberikan satu kesan yang buruk kepada penduduk setempat kawasan tersebut.

Muhammad Shamil (2002) dalam kajiannya yang bertajuk “*Isu Setinggalan dan Kesan Terhadap Alam Sekitar di Lembah Pantai, Kuala Lumpur*” telah menerangkan mengenai isu setinggalan yang kian berlaku di Lembah Pantai, Kerinci yang mana penekanan khusus adalah dalam sektor pekerjaan yang berlaku di kawasan tersebut dan beberapa kesan terhadap alam sekitar juga telah dijelaskan iaitu pembakaran terbuka dan sebagainya dapat memberikan kesan yang buruk kepada penduduk setempat dan menjejaskan kesihatan masyarakat di kawasan tersebut.

Seterusnya, Tuan Azman Tuan Ismail (2005) melakukan kajian yang bertajuk “*Isu Setinggalan, Kes Serta Langkah Kerajaan Mengatasi Masalah Ini, Kajian Kes Ke Atas Kampung Kerinci*”. Kajian ini menjelaskan mengenai isu setinggalan yang berlaku di Kerinci iaitu kebanyakan berlaku adalah disebabkan migrasi dari luar bandar ke bandar dan pelbagai kes telah dikenal pasti antaranya ialah pendidikan, perkhidmatan, pekerjaan dan sebagainya untuk mengatasi isu ini pelbagai langkah telah dicadangkan untuk kebaikan bersama.

Muhammad Rashid Rajuddin (2006) pula telah melakukan kajian tentang “*Penglibatan Tenaga Kerja Tempatan Di Sektor Pembinaan di Malaysia*”. Penulisan ini mengupas mengenai

industri pembinaan di Malaysia mengalami kekurangan tenaga kerja yang kritikal, sumber tenaga kerja tempatan tidak dapat menampung permintaan tenaga kerja binaan yang semakin meningkat dan ini menyebabkan kontraktor lebih cenderung untuk mengambil tenaga kerja asing. Pengambilan tenaga kerja yang ramai telah menyebabkan kepada ketidakseimbangan taburan tenaga kerja. Keadaan ini telah membawa satu impak yang negatif kepada industri tersebut kerana kurang menerima sambutan daripada warga tempatan kerana ini merupakan satu sektor yang penting dalam pembangunan negara.

Che Hashim (2009) pula melakukan kajian yang bertajuk "*Buruh Asing di Malaysia, Trend, Kaedah, Kesan dan Cara Mengatasinya*". Kajian yang dilakukan ini telah mengupas tentang trend, kaedah dan kesan buruh asing berada di Malaysia. Trend pekerja banyak menceburi dalam bidang pekerjaan di Malaysia sebagai contohnya ialah dalam sektor kurang mahir iaitu, pembantu rumah, pembinaan, perkilangan, perladangan dan pertanian. Sektor ini kebanyakan pekerja berbanding pekerja tempatan ialah pekerja asing kerana pekerja tempatan kurang berminat untuk menceburi dalam bidang tersebut. Kesan kedatangan mereka ke Malaysia akan mengurangkan peluang pekerjaan dan juga rakyat tempatan juga perlu mula untuk bergiat aktif dalam sektor sebegini supaya dapat menambahkan peluang pekerjaan kepada diri mereka sendiri malah jangan hanya bergantung kepada sektor professional sahaja.

Muhamad Fauzi Sukimi (2014) menulis dalam kajiannya yang bertajuk "*Negara, Undang-undang dan Tenaga Kerja Asing*". Kajian yang dilaksanakan ini telah membincangkan mengenai negara yang berlandaskan mengenai undang-undang dan tenaga kerja asing dalam membantu pembangunan negara. Guna tenaga di negara kita bukan sahaja membawa banyak faedah kepada pembangunan negara, ekonomi dan sebagainya tetapi beberapa cabaran dan isu yang amat pincang. Tenaga kerja yang melibatkan luar daripada Malaysia sememangnya tertakluk kepada beberapa peraturan dan undang-undang yang tertentu. Contohnya sektor pembinaan, perkilangan, dan sebagainya. Selain itu, jurnal ini juga mengupas mengenai pengambilan tenaga kerja untuk kerja tertentu yang melibatkan undang-undang tertentu.

Seterusnya, Muhamed Naim (2014) dalam kajiannya yang bertajuk "*Permasalahan Pendatang Asing Tanpa Izin di Malaysia dari Aspek Sosial dan Perundangan*" telah menjelaskan mengenai migrasi yang berlaku di Malaysia. Kebanyakan pendatang asing yang duduk di Malaysia menimbulkan banyak masalah sosial di Malaysia. Antara masalah yang wujud seperti gejala sosial, masuk ke negara tanpa dokumen yang betul dan sebagainya dan pelbagai undang-undang perlu diimplimentasikan untuk mengatasi masalah ini supaya tidak berleluasa.

Akhir sekali, Junaidah.M (2015) telah melakukan kajian yang bertajuk "*Motivasi Migrasi dalam Kalangan Masyarakat di Lembah Pantai*". Penulisan ini telah menyatakan mengenai migrasi masyarakat yang berlaku dari luar bandar ke bandar khususnya di Lembah pantai dan penulis memberikan motivasi atas migrasi tersebut melihat kepada beberapa faktor yang berlaku migrasi tersebut antaranya, pendapatan, pendidikan dan sebagainya dan motivasi ini dapat memberikan satu lonjakan kepada penduduk di luar bandar untuk berhijrah ke bandar.

DAPATAN KAJIAN

Latar Belakang Responden

Latar belakang responden merupakan aspek penting yang perlu dilihat dalam kajian yang dilaksanakan ini. Hal ini demikian kerana mendapatkan maklumat berkaitan latar belakang responden adalah penting bagi menyokong dapatan kajian. Malahan, melalui maklumat latar belakang responden yang dikaji, ia akan memudahkan para pengkaji untuk melakukan analisis. Melalui bahagian ini, penulisan ini membincangkan mengenai latar belakang responden dari

aspek umur, jantina, jenis pekerjaan, sektor pekerjaan yang diceburi dan tempoh pengalaman kerja di Malaysia.

Seramai 20 orang responden dalam kalangan masyarakat Kerinci yang bekerja di sekitar Lembah Pantai, Kuala Lumpur telah dipilih untuk melengkapkan kajian yang dilakukan berkenaan dengan isu dan cabaran ketika mereka bekerja di negara ini.

Jadual di bawah merupakan data demografi yang dikumpul terhadap keseluruhan responden. Jadual tersebut merangkumi data berkenaan dengan jantina, umur, tempoh bekerja di Malaysia, jenis pekerjaan dan sektor pekerjaan responden.

Bilangan	Jantina	Umur	Tempoh Bekerja di Malaysia	Jenis Pekerjaan	Sektor Pekerjaan
1.	Lelaki	26	6 bulan	Buruh	Pembinaan
2.	Perempuan	27	2 tahun	Pembantu rumah	Perkhidmatan
3.	Lelaki	30	3 tahun	Tukang sapu	Perkhidmatan
4.	Lelaki	31	6 tahun	Pekerja restoran	Perkhidmatan
5.	Perempuan	29	5 tahun	Tukang sapu	Perkhidmatan
6.	Lelaki	26	3 tahun	peladang	Perladangan
7.	Lelaki	29	4 tahun	Pembantu kedai	Perkhidmatan
8.	Lelaki	35	8 tahun	Pekerja restoran	Perkhidmatan
9.	Perempuan	28	5 tahun	Kilang	Pembuatan
10.	Perempuan	27	6 tahun	Tukang masak	Perkhidmatan
11.	Perempuan	49	15 tahun	Kilang	Pembuatan
12.	Lelaki	39	10 tahun	Buruh	Pembinaan
13.	Perempuan	51	13 tahun	Tukang masak	Perkhidmatan
14.	Perempuan	33	9 tahun	Kilang	Perkhidmatan
15.	Lelaki	24	2 tahun	Cuci kereta	Perkhidmatan
16.	Lelaki	44	20 tahun	Buruh	Pembinaan
17.	Lelaki	56	22 tahun	Pemandu lori	Perkhidmatan
18.	Perempuan	38	13 tahun	Pembantu kantin	Perkhidmatan
19.	Lelaki	59	18 tahun	Buruh (Mandor)	Perkhidmatan
20.	Lelaki	25	4 tahun	Pembantu kedai	Perkhidmatan

Jadual 1.1: Latar Belakang Responden

Jadual di atas menunjukkan kepelbagaian profil responden yang telah dikumpul oleh para pengkaji. Profil responden dibincangkan dengan lebih lanjut bermula dengan jantina, umur, tempoh bekerja di Malaysia, jenis pekerjaan dan sektor pekerjaan responden. Data demografi diperoleh daripada profil responden bertujuan untuk menyokong kesahihan kajian yang dilakukan. Seramai dua belas orang responden terdiri daripada lelaki dan lapan orang responden terdiri daripada perempuan. Selain itu, umur responden pula bermula dari

lingkungan 24 hingga 59 tahun. Selanjutnya, tempoh masa responden bekerja di Malaysia pula adalah antara 6 bulan hingga 22 tahun. Seterusnya, jenis pekerjaan yang dilakukan oleh responden adalah seperti buruh, pembantu rumah, tukang sapu dan lain-lain. Akhir sekali, bagi sektor pekerjaan yang diceburi oleh responden adalah terdiri daripada sektor perkhidmatan, pembuatan, perladangan dan pembinaan. Oleh itu, kepelbagaian latar belakang responden boleh dianggap sebagai aset kepada keputusan kajian.

Jantina

Jantina merupakan salah satu aspek yang boleh dilihat menerusi jenis dan sektor pekerjaan yang diceburi oleh responden. Mengikut data yang diperolehi, jumlah responden lelaki adalah seramai sebelas orang, manakala jumlah responden perempuan adalah seramai sembilan orang. Maka, jumlah kesemua responden yang telah ditemui adalah seramai dua puluh orang.

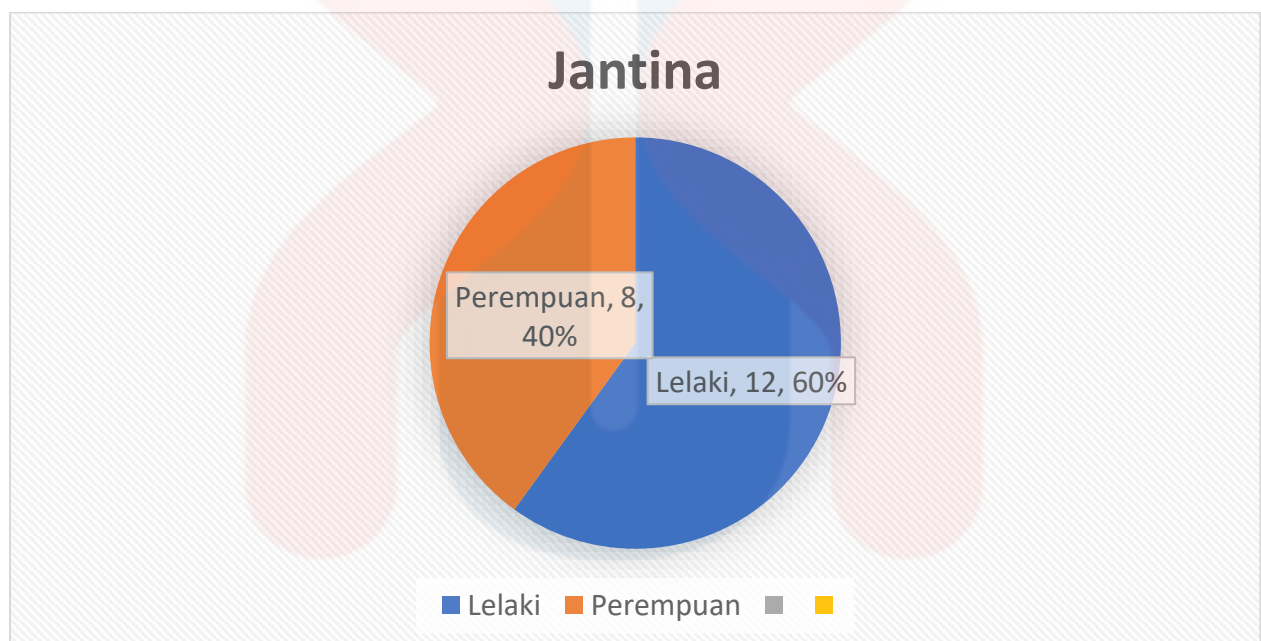

Rajah 1.1: Peratusan Jantina Respondan

Umur

Umur juga merupakan aspek penting untuk dilihat terhadap seseorang responden. Kebanyakan kajian mengenai pekerja dari luar menunjukkan kebarangkalian besar penghijrahan berlaku adalah daripada golongan muda. Hal ini demikian kerana dalam usia yang muda, individu boleh menikmati faedah serta pengalaman yang luas melalui penghijrahan. Manakala semakin berusia seseorang, semakin kurang kecenderungan untuk melakukan penghijrahan. Malahan, golongan muda juga berkemungkinan lebih dipilih untuk diambil bekerja berbanding golongan yang lebih berusia. Hal ini demikian kerana tenaga golongan muda amat diperlukan kerana kemampuan mereka untuk melakukan kerja-kerja yang berat adalah tinggi. Oleh itu, berdasarkan kajian yang dilakukan ini menunjukkan bahawa kebanyakan pekerja daripada masyarakat kerinci yang bekerja di sekitar Lembah Pantai merupakan golongan muda. Aspek umur sememangnya mempengaruhi bidang pekerjaan yang diceburi oleh mereka. Hal ini demikian kerana melalui umur para responden akan bekerja mengikut kesesuaian kerja yang mampu dilakukan mengikut umur mereka.

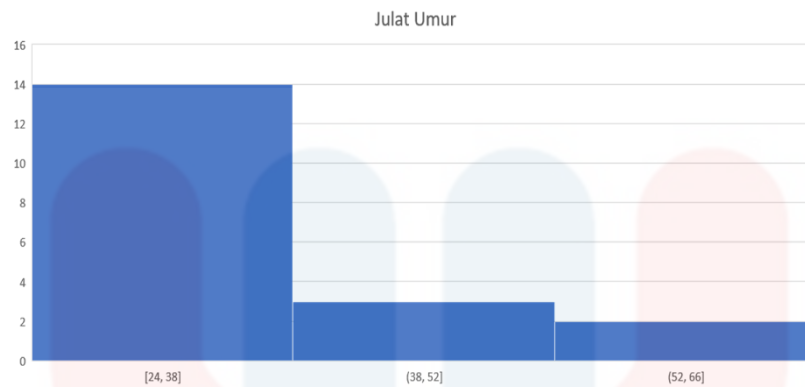

Rajah 1.2: Peratusan Julat Umur Respondan

Tempoh Bekerja di Malaysia

Berdasarkan dapatan kajian, tempoh semua responden bekerja di Malaysia antara 6 bulan hingga 22 tahun. Data juga menunjukkan bahawa seramai seorang responden yang sudah bekerja di Malaysia selama 6 bulan dan seorang responden yang sudah bekerja di Malaysia selama 22 tahun. Manakala responden yang lain adalah antara tempoh seperti yang dinyatakan. Tempoh masa responden bekerja di Malaysia ini juga akan mempengaruhi sejauh mana isu dan cabaran yang dihadapi oleh mereka.

Pekerjaan

Pekerjaan responden dalam kajian ini adalah tertumpu pada sektor perkhidmatan, pembinaan, pembuatan dan perladangan.

Isu dan Cabaran Kerja yang Dihadapi Oleh Masyarakat Kerinci di Malaysia

Isu dan Cabaran kerja yang dihadapi oleh masyarakat Kerinci di Malaysia telah dibahagikan kepada beberapa bahagian. Kesemua cabaran ini didapati hasil daripada kenyataan responden sendiri. Jadual di bawah mengandungi cabaran utama dihadapi oleh pekerja masyarakat Kerinci yang dikenal pasti dalam sesi temu bual bersama responden. Antara cabaran yang dihadapi oleh mereka sepanjang bekerja di Malaysia adalah seperti diskriminasi, ditipu majikan, masalah psikologi dan masalah di tempat kerja.

Isu dan Cabaran	Deskripsi
Diskriminasi	Penindasan terhadap pekerja Kerinci. Penindasan daripada majikan dan masyarakat.
Masalah di tempat kerja	Respondan mendakwa masalah dari segi segala aspek kerja yang diceburi seperti gaji, persekitaran tempat kerja dan kerja secara paksa.
Masalah psikologi	Fikiran terganggu disebabkan tekanan daripada majikan, tekanan kerja, persekitaran sekeliling dan cabaran yang dialami merupakan perkara yang dikenal pasti dalam temu bual terhadap responden.
Ditipu majikan	Ditipu dari segi gaji dan jenis pekerjaan yang ditawarkan sebelum bekerja.

Jadual 1.3 :Isu dan Cabaran Kerja yang dihadapi kaum Kerinci

Bilangan	Jantina	Jenis Pekerjaan	Sektor	Isu dan Cabaran
1.	Lelaki	Buruh	Pembinaan	Psikologi – kepenatan
2.	Perempuan	Pembantu rumah	Perkhidmatan	Diskriminasi – dihina dengan kata dan perbuatan kesat
3.	Lelaki	Tukang sapu	Perkhidmatan	Psikologi – dihina oleh majikan
4.	Lelaki	Pekerja restoran	Perkhidmatan	Diskriminasi – memberikan kerja lain semasa bekerja berbanding orang lain
5.	Perempuan	Tukang sapu	Perkhidmatan	Tempat kerja – gaji lewat
6.	Lelaki	peladang	Perladangan	Diskriminasi – layanan tak adil kepada responden berbanding pekerja lain
7.	Lelaki	Pembantu kedai	Perkhidmatan	Diskriminasi – gaji tak setimpal dengan kerja yang diberikan
8.	Lelaki	Pekerja restoran	Perkhidmatan	Tempat kerja – keselamatan tempat kerja (dapur)
9.	Perempuan	Kilang	Pembuatan	Majikan – perubahan jenis pekerjaan semasa menerima surat tawaran dan ketika mendaftarkan diri di syarikat
10.	Perempuan	Tukang masak	Perkhidmatan	Majikan – ditipu majikan
11.	Perempuan	Kilang	Pembuatan	Tempat kerja – gangguan seksual
12.	Lelaki	Buruh	Pembinaan	Tempat kerja – bergaduh dengan rakan sekerja
13.	Perempuan	Tukang masak	Perkhidmatan	Diskriminasi – cuti hanya dua kali dalam sebulan.
14.	Perempuan	Kilang	Perkhidmatan	Psikologi – kepenatan
15.	Lelaki	Cuci kereta	Perkhidmatan	Tempat kerja – tidak diberi cuti (kurang pekerja)
16.	Lelaki	Buruh	Pembinaan	Psikologi – sering dimarahi majikan
17.	Lelaki	Pemandu lori	Perkhidmatan	Psikologi – kepenatan
18.	Perempuan	Pembantu kantin	Perkhidmatan	Tempat kerja – bergaduh dengan rakan sekerja
19.	Lelaki	Buruh (Mandor)	Perkhidmatan	Tempat kerja – sering dibuli dengan pekerja lain
20.	Lelaki	Pembantu kedai	Perkhidmatan	Psikologi – terpaksa panjangkan waktu kerja

Jadual 1.4: Diskripsi isu dan cabaran kerja kaum Kerinci

Diskriminasi

Diskriminasi boleh dirujuk kepada pelbagai definisi dan mempunyai pelbagai tafsiran yang tertentu. Antaranya ialah diskriminasi merujuk kepada layanan yang tidak adil terhadap sekelompok individu yang tertentu, iaitu layanan ini diberi berdasarkan kumpulan yang diwakili oleh individu yang berkenaan. Shepherd (2008) telah memberikan definisi diskriminasi ialah suatu amalan yang kebiasannya dijumpai dalam sekelompok manusia dan ia berpunca daripada kecenderungan manusia untuk membeza atau mengelaskan manusia lain. Diskriminasi boleh berlaku dalam pelbagai konteks sama ada dilakukan oleh individu, institusi, firma malah oleh kerajaan itu sendiri juga boleh berlaku.

Selain itu, perlakuan diskriminasi berlaku apabila seorang majikan memberikan gaji yang tidak setimpal kepada pekerjanya mengikut kepada peraturan yang ditetapkan oleh kerajaan, gaji untuk seorang pekerja wajib dibayar selepas 26 hari bekerja dan pekerja berhak untuk mendapatkannya. Diskriminasi terhadap pekerja asing pula boleh dikategorikan kepada corak diskriminasi yang dihadapi oleh bukan warganegara di Malaysia. Bukan warganegara menderita diskriminasi berkenaan dengan asas mereka, corak yang akan memberikan suasana keganasan, tahanan diskriminasi yang dihantar pulang ke negara asal kerana tiada dokumen perjalanan yang terhad, kekurangan akses kepada keadilan, kekurangan kehidupan keluarga, penjagaan kesihatan terhad atau tidak wujud dan pendidikan dan perumahan. Diskriminasi terhadap bukan warganegara memberikan kesan kepada beberapa kategori dalam penduduk bukan warganegara termasuk pelarian yang mengalami diskriminasi dan kelemahan dalam proses pelarian penentuan status dan pekerjaan serta pekerja asing yang mana pekerja domestik adalah terutamanya terdedah kepada seksyen tertentu *The Equal Rights Trust (ERT) & Tenaganita (2012)*.

Oleh itu, berdasarkan diskriminasi yang telah dialami oleh beberapa orang responden ini, pengkaji telah menyenaraikan beberapa jenis diskriminasi yang dialami oleh beberapa orang responden ini berdasarkan temubual bersama mereka. Antara diskriminasi yang dialami oleh responden ialah didiskriminasikan oleh penduduk tempatan itu sendiri. Sebanyak 5 orang responden mendakwa mereka telah dilayan seperti masyarakat kelas kedua. Respondan dan rakan-rakannya pernah dihina dengan panggilan atau nama yang tidak elok, mereka dianggap sebagai “Kuli” oleh sesetengah penduduk tempatan. Malahan, penduduk tempatan menganggap mereka sebagai manusia kelas kedua disebabkan mereka pekerja asing yang bekerja dalam sektor yang dinamakan sebagai sektor 3D iaitu “Dirty, Dangerous, Difficult”. Mereka mempunyai tanggapan bahawa kaum Kerinci ini tidak mempunyai taraf yang sama dengan mereka. Bagi responden yang lain pula yang bekerja di sebuah kilang telah menyatakan beliau mendapat diskriminasi oleh majikan di tempat kerjanya apabila majikannya melayaninya dengan begitu kasar dengan memanggil dengan panggilan yang tidak elok dan sering memarahinya, dan pekerja tempatan sering membulinya ketika waktu kerja dengan memberi tugas kerja yang begitu banyak dan meminta responden menghabiskan kerja tersebut dengan segera. Respondan yang ditemui juga mendakwa pekerja dari kaum Kerinci di daerah tersebut diarahkan untuk bekerja pada hari cuti umum juga. Hal ini bertujuan untuk mengisi kekosongan pekerja tempatan yang bermohon cuti pada waktu tersebut. Berdasarkan temu bual bersama responden juga telah mendakwa:

“Sesetengah orang di negara ini tidak berkelakuan baik. Mereka fikir kami datang ke sini untuk merampas makanan, wang dan tempat mereka. Mereka layan kami seperti orang kelas-2. Ia benar-benar menyedihkan”

(Luahan responden 2)

Berdasarkan kepada luahan tersebut, dapat dinyatakan dengan jelas bahawa tanggapan atau persepsi masyarakat adalah sangat berbeza terhadap mereka kerana dalam konteks yang

luas jikalau berfikir dengan logik, mereka datang ke sini adalah hanya untuk menyara hidup mereka. Selain itu, wujud masyarakat Kerinci yang dinafikan hak mereka dalam perkhidmatan awam. Selain itu, mengikut temu bual bersama seorang responden yang pernah bekerja sebagai penternak kambing, beliau pada asalnya dijanjikan bekerja di dalam sektor perhotelan, namun telah ditipu oleh ejen dan diletakkan bekerja sebagai penternak kambing di sebuah pusat penternakan di Sungai Buluh Selangor. Walaupun diletakan dalam bidang yang tidak berkaitan selepas 6 bulan bekerja, beliau tidak dibayar gaji oleh majikan dan atas desakan tersebut beliau melarikan diri dan mencari pekerjaan lain.

Selain itu, terdapat seorang responden telah mendakwa bahawa beliau juga hanya diberi cuti 2 kali dalam masa tempoh 6 bulan. Beliau sering diberi kerja yang lebih dan majikannya mengeksploitasi sepenuh tenaganya untuk bekerja demi sesuap nasi, keadaan menjadi keruh jika beliau mengadu dan mempersoalkan tentang layanan majikannya lalu majikan akan mengambil tindakan terhadapnya. Hal ini menyebabkan beliau takut dan terpaksa menerima sahaja segala arahan majikan walaupun ianya berbentuk diskriminasi terhadapnya.

Diskriminasi sebegini akan memberikan satu tamparan yang buruk kepada pekerja kaum Kerinci dan akan memberi kesan kepada pembangunan negara. Justeru, pelbagai usaha perlu diambil untuk mengekang masalah ini.

Masalah di Tempat Kerja

Antara masalah utama yang dihadapi oleh pekerja ialah masalah di tempat kerja mereka dan masalah ini merangkumi pelbagai masalah seperti masalah gaji, masalah kebajikan pekerja dan masalah persekitaran kerja. Masalah utama yang dihadapi oleh pekerja kaum Kerinci berkenaan dengan isu masalah seperti kelewatan majikan membayar gaji. Terdapat 7 responden yang mengalami masalah di tempat kerja. Berdasarkan daripada seorang dakwaan responden, beliau mendakwa pernah mengalami masalah kelewatan pembayaran gaji oleh majikan. Beliau mengatakan pernah dibayar gaji lewat selama hampir dua bulan dan alasan majikan membayar lewat adalah kerana mereka mengalami masalah kewangan untuk membayar gaji pekerja. Hal ini secara langsung menyebabkan beliau mengalami kesusahan untuk menguruskan hal kewangan pada bulan tersebut. Namun, hasil daripada pertolongan oleh rakan-rakan dan sedikit sumbangan oleh saudara-mara telah mengurangkan sedikit beban untuk menampung kos sara hidup kerana mereka sudi untuk membantu.

"Saya pernah lewat dibayar gaji oleh majikan kerana katanya mempunyai masalah kewangan pada masa itu. Saya banyak perlu tanggung untuk keperluan keluarga dan sebagainya. Jadi saya terpaksa pinjam duit daripada orang lain untuk kegunaan harian saya."

(Luahan responden 5)

Selain itu, responden juga mendakwan bahawa beliau tidak dijaga kebajikan oleh majikan mereka dari aspek keselamatan, kemudahan tempat tinggal dan persekitaran tempat kerja. Salah seorang responden merupakan bekerja sebagai buruh di tapak pembinaan bangunan dan pihak majikan tidak menyediakan kemudahan tempat tinggal yang selesa dan selamat kepada mereka dan mereka terpaksa tinggal di dalam rumah kongsi yang sempit kerana keluasan rumah kongsi tersebut hanya sesuai untuk 5 orang sahaja sedangkan mereka terpaksa berkongsi antara 10 orang atau lebih daripada itu.

Justeru, hal ini akan menyebabkan mereka tinggal dalam keadaan yang tidak selesa dan perkara ini telah melanggar garis panduan penetapan minimum penginapan pekerja bahawa garis panduan ini terpakai kepada tempat pekerjaan yang diliputi di bawah Akta Standard-Standard Minimum Perumahan dan Kemudahan Pekerja 1990 (Akta 446). Maka, di bawah garis panduan ini menjelaskan bahawa bagi tempat penginapan yang menggunakan bangunan

yang sedia didiami, setiap pekerja hendaklah diberi ruang bertutup sepenuhnya tidak kurang daripada 4.5 meter persegi ini akan pengiraan anggaran bagi bilangan penduduk sesebuah unit kediaman.

Seterusnya, keselamatan di tempat kerja juga tidak dijaga rapi oleh majikan. Salah seorang responden juga mendakwa terdapat satu kes kemalangan yang melibatkan dirinya. Respondan telah tercedera semasa melakukan kerja pemasangan bumbung yang telah mengakitkannya cedera di bahagian kepala dan kaki akibat melakukan kerja pemasangan bumbung di tempat kerjanya. Respondan tersebut telah cedera di bahagian kepala dan kaki akibat ditimpa simen yang jatuh terputus daripada tali yang diikat yang digunakan untuk mengangkut simen tersebut naik ke bangunan yang lebih tinggi dan didapati tali yang digunakan untuk mengangkut simen tersebut tidak diikat dengan kemas dan tali tersebut didapati telah usang serta boleh terputus kerana tidak sesuai untuk menampung berat alat binaan tersebut. Hal ini dengan jelas menunjukkan responden terpaksa berhadapan dengan pelbagai cabaran dari segi keselamatan di tempat kerja akibat daripada pihak majikan dan pengurusan yang tidak menitik beratkan aspek keselamatan.

Masalah Psikologi

Respondan yang merupakan masyarakat Kerinci turut mengalami masalah psikologi ketika bekerja di negara ini. Masalah psikologi yang dialami oleh responden dikatakan berpunca daripada cabaran-cabaran yang dihadapi oleh mereka ketika bekerja. Justeru, cabaran-cabaran ini telah memberi kesan psikologi yang mendalam terhadap mereka. 6 Respondan mendakwa mereka telah mengalami kesan psikologi disebabkan tekanan kerja dan layanan majikan terhadap mereka. Mereka juga mendakwa hasil daripada tekanan ini telah menyebabkan mereka mengalami kemurungan. Mengikut daripada salah seorang dakwaan responden, beliau mengatakan masalah psikologi yang dialaminya adalah berpunca daripada tekanan kerja yang terlalu banyak. Hal ini demikian kerana majikannya telah memaksanya untuk bekerja hampir sepanjang hari dan bekerja untuk dua kerja dalam masa satu masa yang. Ini telah menyebabkan beliau terpaksa menanggung beban kerja yang banyak dan tidak mempunyai masa yang mencukupi untuk berehat. Bagi seorang lagi responden pula, beliau pula mengatakan bahawa masalah psikologi yang dialaminya adalah disebabkan layanan oleh majikannya. Respondan mendakwa majikannya melayaninya seperti masyarakat kelas kedua. Respondan turut mengatakan bahawa majikannya sering menganggap golongan seperti mereka adalah sebagai individu atau kelompok yang tidak setaraf dengan masyarakat biasa disebabkan mereka ini dikatakan kebanyakannya melakukan kerja yang dikatakan kotor, bahaya dan susah. Malahan, responden turut mengatakan majikannya seolah-olah sering mencari kesalahan dan memaharinya hampir setiap hari tanpa sebab yang munasabah. Justeru, perkara seperti ini akan memberi kesan psikologi terhadap mereka. Hal ini juga akan menyebabkan responden berasa tertekan dengan layanan yang diberikan terhadap mereka sekali gus boleh menyebabkan mereka mengalami kemurungan dan tekanan jiwa yang membimbangkan.

”Saya tidak ada masalah dengan kerja yang diberikan cuma majikan saya suka beri tekanan kepada saya kerana dia sering kali memarahi saya tanpa sebab. Jadi kadang-kadang saya terbawa masalah ini sampai ke rumah kerana memikirkan apa yang telah dilakukan oleh majikan terhadap saya.”

(Luahan responden 16)

Masalah Ditipu Majikan

Bagi isu dan cabaran ditipu majikan, dua responden telah menceritakan pengalaman mereka ditipu majikan. Penipuan majikan terhadap para pekerja selalunya berkait rapat dengan masalah gaji dan jenis pekerjaan.

Bagi salah seorang responden, beliau mengatakan masalah ditipu majikan adalah kerana majikannya telah membayar gajinya lewat daripada perjanjian asal. Respondan turut mendakwa, gaji yang diterima adalah lewat dan pada masa yang sama gajinya telah dipotong dengan alasan yang tidak munasabah seperti kesalahan daftar masuk kehadiran lambat yang disebabkan masalah ralat dalam sistem daftar masuk kehadiran pekerja. Menurut Seksyen 19 (1) Akta Kerja 1955, hari terakhir gaji perlu diberikan 7 hari selepas hari gaji yang sepatutnya.

"Majikan saya pernah berjanji untuk membayar gaji pada tarikh yang dijanjikan tetapi dia tidak membayarnya pada tarikh yang dijanjikannya. Saya tahu ada undang-undang bahawa gaji perlu dibayar 7 hari selepas hari gaji yang sepatutnya. Malahan gaji saya juga turut dipotong dengan alasan yang tidak munasabah juga".

(Luahan responden 10)

Selain itu, seorang lagi responden telah mengatakan bahawa beliau turut mempunyai pengalaman ditipu majikan dalam jenis pekerjaan. Antara pengalamannya ialah, beliau telah dijanjikan bidang kerja lain semasa penerimaan tawaran kerja dan ketika mendaftarkan diri disyarikat tersebut atas sebab masalah ralat oleh kecuaiannya pegawai sumber manusia di syarikat tersebut. Oleh itu, berlaku pertikaian dan perubahan tangga gaji dalam yang perlu diselaraskan semula mengikut gaji dan bidang kerja baharu yang ditetapkan.

KESIMPULAN

Kesimpulannya, kajian ini telah mencapai objektunya dengan wujudnya isu dan cabaran kerja dalam kalangan masyarakat Kerinci. Antara permasalahan yang dapat disenaraikan ialah masalah ditipu majikan, diskriminasi, psikologi dan masalah di tempat kerja. Oleh yang demikian, masalah isu dan cabaran mengenai kerja ini sememangnya dirasai oleh masyarakat Kerinci itu sendiri. Oleh itu, semua pihak perlu mengambil langkah bagi mengurangkan isu dan cabaran di tempat kerja sama ada dalam kelompok tertentu atau semua pihak. Pada masa yang sama, masyarakat perlu menguasai ilmu supaya ilmu yang dipelajari dapat diterapkan di tempat kerja. Malahan, pihak majikan juga perlu memainkan peranan supaya suasana kondusif di tempat kerja dapat dilaksanakan secara berterusan.

RUJUKAN

- Abdul Hakam Jamaluddin. (2001). *Satu Penulisan Mengenai Kampung Kerinci*. Universiti Kebangsaan Malaysia, Bangi.
- Appleyard. (2000). *International Migration and Development*. Us Press.
- Che Hashim. (2002). *Buruh Asing di Malaysia, Trend, Kaedah, Kesan dan Cara mengatasi*. Universiti Kebangsaan Malaysia, Bangi Selangor.
- Kamus Dewan Edisi Kedua*. (1984). Kuala Lumpur. Dewan Bahasa dan Pustaka.
- Muhammed Naim. (2014). *Permasalahan pendatang Asing tanpa izin di Malaysia dari Aspek Sosial dan Perundang*. Universiti Malaya
- Muhamad Fauzi Sukimi. (2014). *Negara, undang-undang dan tenaga kerja asing: Satu Tinjauan Dari perspektif ekonomi dan sosio budaya*. Fakul Sains Sosial, Universiti Malaysia Sarawak.

- Muhammas Faizul Al-Jaffary. (2001). *Impak alam sekitar membawa isu permasalahan kini, masalah kesesakan tempat tinggal di Kerinci*. Fakulti Sastera dan Sains Sosial, Universiti Malaya.
- Muhammad Shamil. (2002). *Isu setinggan dan kesan terhadap alam sekitar*. Fakulti Sastera dan Sains Sosial, Universiti Malaya.
- Muhammad Rashid Rajuddin. (2003). *Penglibatan Tenaga Kerja di Sektor Pembinaan di Malaysia*.
- Othman Lebar. (2014). *Penyelidikan Kualitatif: Pengenalan kepada Teori dan Metode*. Tanjong Malim: Penerbit Universiti Pendidikan Sultan Idris.
- Universiti Malahamed Ali. (1997). *Penghijarahannya Pendatan Asing ke Malaysia: Satu Tujuan Perspektif*, Universiti Malaya.
- Junaidah Wandi. (1995). *Proses Pembelajaran dan Penyesuaian di Bandar, Lembah Pantai, Kerinci*. Fakulti Sastera dan Sains Sosial, Universiti Malaya.
- Junaidah. (2015). *Motivasi Migrasi dalam kalangan masyarakat di Lembah Pantai*. Fakulti Sastera Dan Sains Sosial, Universiti Malaya.
- Samarin, William. J., (1993). *Linguistik Lapangan : Panduan Kerja Lapangan Linguistik*. Diterjemah oleh: Kamaruzaman Mahayiddin dan Zahrah Abd Ghafur. Kuala Lumpur: Dewan Bahasa Dan Pustaka.
- Tuan Azman Tun Ismail. (2005). *Isu Setinggan, kes serta langkah kerajaan mengatasi masalah ini: Kajian Kes ke atas kampung Kerinci*, Universiti Malaya.

Ontology of Social Networking Sites Related to Ibn Khaldun's Thoughts: Evaluation Approaches

Mohamad Hafizuddin Mohamed Najid
*Faculty of Science and Technology,
Islamic Science University of Malaysia
hafizuddin.najid@usim.edu.my*

Zahidah Zulkifli
*Kulliyah of Information and Communication Technology,
International Islamic University Malaysia
zahidahz@iium.edu.my*

Roslina Othman
*Kulliyah of Information and Communication Technology,
International Islamic University Malaysia
roslina@iium.edu.my*

Rohaiza Rokis
*Kulliyah of Islamic Revealed Knowledge and Human Sciences,
International Islamic University Malaysia
rohaiza@iium.edu.my*

Ashraf Ali Salahuddin
*Editor at QATIBS, 27 Bijoy Nagar, Dhaka, Bangladesh
ashraf@qatibs.com*

ABSTRACT

This paper aims to evaluate two essential aspects of ontologies: consistency and correctness. Thus, this research focuses on the evaluation activities performed during the ontology development of ethical issues in social networking sites based on Ibn Khaldun's thoughts. The evaluation stage consists of four sub-stages: validation and verification following the guideline and criteria; SPARQL query testing, and user assessment. Three experts were interviewed to validate the ontology and verify the semantic relationship. The evaluation phase met the criteria referred to in this research and all the execution in the SPARQL query were successful. For users' assessment, 62% of the results were categorised as suitable. Ontology evaluation approaches signify the importance to ensure the accurate sources and trustworthiness of Ibn Khaldun's thoughts suggested to users to assist them to deal with the challenge and issues in accessing the social media platform using the ontology concepts.

Keywords: *Ontology evaluation; Twitter; Ibn Khaldun; SPARQL query*

INTRODUCTION

Ontology is a structure used to capture knowledge about a certain domain by providing related concepts and relationships between them. It offers a knowledge-sharing framework that facilitates the representation and sharing of domain knowledge in understanding a field (Halawi et al., 2018). The structure also included the formal naming and definition of the types, properties, and interrelationships of entities that occur for a certain domain of discourse. It was often created to limit complexity and to organize information in research fields as a way of representing a common understanding of a domain (Zheng, 2017).

However, the consistency and correctness of the object evaluation are important considerations in the evaluation process. The concept of ontology evaluation namely verification and validation and that can be found in all categories. Methods and frameworks for task-based evaluation may be categorized as either verification (quality) or validation (correctness). More importantly, the appropriate method for ontology evaluation must be determined by the purpose of evaluation, the application in which the ontology may be used and the feature of the ontology that we are attempting to evaluate (Bansal & Chawla, 2016). Ontology validation checks whether the correct ontology was built, while ontology verification determines whether the ontology was built correctly. Ontology verification ensures that the ontology was created in accordance with ontology quality criteria. In this regard, two validation approaches are used to obtain the process. The first is the evaluation of ontology content and the second is answering competency questions (Alsanad et al., 2019).

The ontology evaluation stage in this research is focused on ontology design verification and technical competence validation. It is conducted after the ontology formalization phase. The highlight of this assessment is to improve the reuse of the ontology model and utility aspect as a practice for judging the ontology content from the user's point of view as described by (Gómez-Pérez et al., 2004). Accordingly, the evaluation must transcend its descriptive role to assist and direct us in the creation of high-quality ontology. In Methontology, which is the ontology development method employed in this research, evaluation is primarily performed during the conceptualization process, but it can also be carried out during each phase and between phases of the subsequent lifecycle. It allows for the validation of the correspondence between modelled elements and the system they are meant to represent, as well as the verification of the correctness of the ontology to the specification document (Nefzi et al., 2014). The evaluation of ontology is an important step in developing a good ontology, as shown in our methodology of designing domain ontologies.

Overall, this paper presents the ontology evaluation process of this research work through the ontology model which has been developed. The knowledge acquisition for this developed ontology has been published in Najid et.al (2021). The focuses are to analyze the interview results from the experts to validate and verify the ontology semantic relationship between ethical issues from tweets on Twitter based on Ibn Khaldun's thoughts. Thus, the competency questions will be executed in the SPARQL Query in Protégé to ensure the expressiveness of the ontology. User assessment will be passed to the qualified users in determining the suitability of the output from the ontology. The evaluation process aims to meet the research objective by assessing developed ontologies of ethical issues in social networking sites (SNS) based on Ibn Khaldun's thoughts. This also needs to answer the research question which is how ontologies of ethical issues in SNS will based on Ibn Khaldun's thoughts meet the expert's expectations and how do these ontologies meet the basic and competency questions based on the suggested model.

LITERATURE REVIEW

Ontology evaluation can be defined as the method of evaluating the quality of an ontology concerning a given criterion to decide which ontology in a collection will better serve a specific purpose (Brank et al., 2005). They can be described as a technical judgment of the substance of an ontology with respect to a frame of reference within and between the phases of its life cycle (Gómez-Pérez et al., 2004). Ontology evaluation is a developing field with a variety of frameworks and methodologies. It plays a significant role for ontology engineers in ensuring that their ontology is accurate and can be published for public use (Vrandecic, 2009). In that

sense, the ontology evaluation utilized the appropriate criteria on the purpose of evaluation and on what viewpoint of the ontology are attempting to be evaluated. However, it was not limited to the criteria of ontology alone. Table 1 below illustrates the finalized list of ontology evaluation criteria and their main elements of details.

Table 36. Ontology Evaluation Criteria

Authors and Year	Evaluation Criteria
Nefzi (2014) et.al	Logical consistency, Conceptual accuracy, Minimal ontological commitment, and Clear separation between ontologies
Gangemi (2006) et.al	Structural measures, Functional measures, Usability-profiling measures
Degbelo (2017)	Evaluation stage of an ontology development process: Accuracy, Adaptability, Clarity, Cognitive Adequacy, Completeness, Conciseness, Consistency, Expressiveness, Grounding Evaluation of the implementation stage: Computational efficiency, Congruency, Practical usefulness, Precision, Recall
Kreider (2013)	Comprehensive, Consistent, Extensible, Ease-of-use
Gruber (1995)	Clarity, Coherence, Extendibility, Minimal encoding bias, Minimal ontological commitment
Fox et.al (1998)	Functional Completeness, Generality, Efficiency, Perspicuity, Precision, Minimality
Gomez-Perez (2004)	Consistency, Completeness, Conciseness, Expandability, Sensitiveness
Yu, Thom and Tham (2005)	Clarity, Consistency, Conciseness, Expandability, Correctness, Completeness, Coverage, Minimal Ontological Commitment, Minimal Encoding Bias

Nefzi et al. (2014) highlighted that evaluation is done practically by assessing the ability of the ontology to fulfil the requirements defined previously as well as determining the consistency, completeness, and conciseness of the ontology. In the evaluation process, the conceptual ontology can be evaluated against a few criteria such as logical consistency, conceptual accuracy, minimal ontological commitment, and clear separation between ontologies. Whereas Gangemi et al. (2006) discussed three types of measures: structural measures, which are typical of ontologies represented as graphs; functional measures, that are related to the intended use of an ontology and of its components that is their function; usability-profiling measures, that depend on the level of annotation of the considered ontology. In practice, the model ontology evaluation is a diagnostic task based on ontology descriptions.

According to Degbelo (2017), since ontologies are of great relevance to the Semantic Web, the importance of ontology evaluation cannot be overstated. Ontology evaluation assesses how good the ontology performs to specific criteria and is necessary for tasks such as ontology ranking or ontology reuse. The listed criteria can be used for the evaluation of the implementation stage to assess the computational properties of the ontology. Knowing how the criteria are related to specific phases is vital for the development of tools that support the evaluation of either the design or the implementation of ontology building.

In the research done by Kreider (2013), the different methods to evaluate and validate the BIM Use Ontology were employed to utilize that the objectives of the evaluation were fulfilled whereby all the elements of the BIM Use Ontology were evaluated. The research aimed to foster better communication within the industry by documenting the BIM Uses and the objective of implementing BIM all through the life of a facility. An ontology will give a common understanding within the industry upon which the implementation of BIM may be normalized.

According to Gruber (1995), the five general design criteria proposed in his paper were basically for evaluation of design decisions in choosing among representations, instead of rules for generating theories. The evaluation of design decisions against the criteria depends on the knowledge accessible and the applications anticipated for a domain. The set of design criteria for ontologies whose purpose is knowledge sharing and interoperation among programs is based on a shared conceptualization.

On the other hand, Fox et al. (1998) have proposed several requirements as a set of queries that the ontology should be able to answer that contains significant information. For example, Functional Completeness in represents the essential information to support some tasks; Generality to share between assorted activities; Efficiency in supports effective reasoning or requires few sorts of transformation; Perspicuity in understood by the users to applied and interpreted across the enterprise; Precision of the ontology support reasoning at different levels and Minimality of the ontology contains the least number of terms or vocabulary.

Meanwhile, Gómez-Pérez et al. (2004) has introduced two terms ontology verification and validation for describing ontology evaluation. For ontology verification, it bargains with building the ontology accurately by ensuring its definitions execute the requirements accurately. Ontology validation refers to whether the meaning of the definitions truly models the real world for which the ontology was created. To evaluate and determine whether a given ontology defines correctly with the listed of following criteria. According to Yu et al. (2005), they have considered how existing criteria and measures can be used to evaluate different aspects of the suitability of ontologies for application areas in the domain of travel and geography. They address the application requirement of appropriate granularity and considered some existing measures of coverage.

METHODOLOGY

Ontology evaluation prepares procedures to evaluate and verify the quality of the developed ontology. The evaluation for ethical issues in SNS based on Ibn Khaldun's thoughts ontology involved the appointment of external experts. The evaluation comprised of validation, verification, competency questions assessment in SPARQL query and user assessment test as shown in Figure 1. Each activity of ontology evaluation assesses the ontology in the following sub-sections.

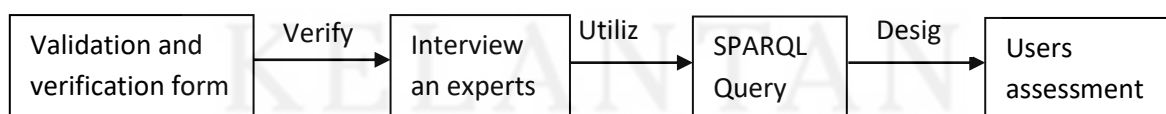

Figure 10. Ontology Evaluation Phase

The criteria for ontology evaluation as suggested by Degbelo (2017) and Kreider (2013) whereby formality is necessary for the analysis to show the relationship. Evaluation involves validation and verification by interviewing three subject experts. The competency questions were executed through SPARQL Query and then the output results are generated for the user assessment test. The validation stage adopting criteria suggested by Kreider and Degbelo on how the ontology relationship need to be evaluated. The verification stages were based on a two-point scale assessment: Accurate and Inaccurate. If the term is Unclear or Partially Suitable, the experts need to comment in the remarks box.

One hundred and forty-six (146) competency questions were constructed for execution and identification of results through SPARQL Query. Then, the results from the SPARQL Query were determined in the user assessment part and given to the participating users to evaluate the ontology content. Users made a judgment whether Ibn Khaldun's thoughts and assigned tweets meet the suitability. The role of an expert is preferred to validate the concepts identified from Ibn Khaldun's discourse to avoid conflict and bias during the ontology development process. This ensured that the developed ontologies of ethical issues in Twitter based on Ibn Khaldun's thoughts met quality standards and contained authentic data.

Validation

Validation evaluates the quality of ontology and assures the knowledge construct in ontology complied with the selected criteria with the cooperation of domain and ontology experts. It is an essential part in comparing the cooperation of domain in a developed ontology and confirming that the knowledge encoded in the ontology abide by the selected criteria. It helps to diminish data irregularity and hence ensures that the knowledge is accurate and meets expectations. Experts' validation is on the ontology of Ibn Khaldun's thoughts which are related to a semantic relationship with SNS issues from Twitter. The experts justified the structured interview questions as a validation form containing the criteria to be evaluated as a tool to execute the evaluation tasks. They were to review the prepared concepts and rate their status of compliance with the selected evaluation criteria. The significance of the ontology developed was thus analyzed with regards to ethical issues in SNS related to Ibn Khaldun's thought.

In this process, the stage of validation involved three experts from two different backgrounds. Two of the experts are from the Information Technology Department who reviews the ontology of Ibn Khaldun's thoughts and the sentiment analysis of tweets ethical issues from Twitter. The other expert is from the Human Sciences Department reviewing the concepts of Ibn Khaldun's thoughts and the concepts assigned for tweets from Twitter.

Verification

The verification stage refers to the technical process that guarantees the correctness of an ontology. It refers to its association with the software environments, and documentation during each phase and between phases of their life cycle. The same experts conducted the verification in a way like the validation process based on their expertise. They verified the accuracy of the concepts by relating the ethical issues in SNS with Ibn Khaldun's thought and their corresponding concepts. The experts were given the verification form as a tool to execute the verification tasks. For verification, they were provided a different type of content in the prepared documents with a two-point scale assessment: Accurate and Inaccurate. If the term is Unclear or Partially Suitable, the experts must include a comment in the remarks box. The details of the activity for both experts were as follows:

1. The expert from the Information Technology Department

These two experts were assigned the tasks of verification in the prepared documents. Firstly, they were required to review the two lists in the verification forms. List A required a review on the suitability of the concepts assigned for Ibn Khaldun's thoughts. Then, List B required a review on concepts assigned for tweets from Twitter. As a second task, they had to review three lists: List A is about Ibn Khaldun's thoughts related to negative tweets from Twitter, List B is a list of positive tweets from Twitter and lastly, List C is a list of neutral tweets from Twitter. The experts were required to comment on the correctness of Ibn Khaldun's thoughts related to the sentiment analysis which were classified through users' tweets from Twitter.

2. The expert from the Human Sciences Department

These experts were assigned to verify the prepared documents. At first, they were required to review the two lists in the verification forms: List A is to review the suitability of the concepts assigned for Ibn Khaldun's thoughts and List B needs to be reviewed the concepts from Ibn Khaldun's thoughts assigned for tweets from Twitter. As a second task, they had to review two lists: List A to identify the correctness of the description of Ibn Khaldun's thoughts and List B to justify the correctness of the description of Ibn Khaldun's thoughts for each subclass assigned in the ontology.

Competency questions assessment in SPARQL query

Competency questions evaluate the expressiveness of the ontology that is required to represent the questions and to characterize their solutions (Grüninger & Fox, 1995). The SPARQL Query Language in Protégé will ensure the validity of the proposed ontology model by expressing real word queries and has proven to be more efficient and accurate (Wagih & Mokhtar, 2016). This is to ensure the correctness of the developed ontology for ethical issues in SNS based on Ibn Khaldun's thoughts. The set of competency questions needs to be assigned in a query language as the preparation before the exact execution on SPARQL Query (Simple Protocol and RDF Query Languages). In the context of this research, SPARQL Query was utilized for the execution of competency questions on the Protégé based on the questions defined from Ibn Khaldun thoughts and tweets issues from Twitter.

Through SPARQL query language, concepts were verified from the relationship of other concepts and could be retrieved not necessarily from its keyword only. This ensures that using an ontology, semantic manipulation, and inference among many following sample queries can be done. For the formalized query language, the competency question was formulated based on Ibn Khaldun's thoughts and the ethical issues identified in tweets from Twitter. Then, the competency questions were submitted to the system using a SPARQL query language. One hundred and forty-six (146) competency questions were constructed for execution and formulated to find out the accuracy and functionality of the ontology providing the answer as well as to check on its correctness. The comment received on the ontology from experts and SPARQL query assessment confirmed that the criteria were met by the ontology. The feedback was based on the findings that will further enhance the direction of the ontology. This contributed to a successful competency assessment to validate the ontology model's correctness and suitability.

User assessment

The user assessment is the final stage of ontology evaluation. According to Degbelo (2017) in their work, ontology evaluation is characterized as a technical judgment of ontology for the frame of reference (Asuncion Gomez-Perez, 2004). As Gómez-Pérez pointed out that the context of references could be the specification of criteria, competency questions, and the real

world in the monitoring of development in ontology and selection of ontology. Technical evaluation is performed by ontology developers and aims to monitor the development progress of ontology; user evaluation is carried out by end-users of ontology and aims to select an ontology for a given purpose. They emphasized that ontology assessment is generally performed by users to determine the quality and consistency of ontology from the users' point of view.

This process involved three experts who had previously been delegated to decide the suitability of the items resulting from ontology and was performed after the competency questions assessment stage produced by the SPARQL Query. The results obtained from the execution of SPARQL Query then transmitted to the participating users to determine whether Ibn Khaldun's thoughts and the ethical issues identified in tweets from Twitter meet the suitability standard depending on the Suitable and Not Suitable scales. They were also asked to give reasons for the selection of the Not Suitable. In this point, the list of Ibn Khaldun's thoughts have been calculated to include in the assessment form based on the chosen Twitter tweets that conveyed a negative sentiment. This process was carried out using the provided form which included each chosen tweet accompanied by Ibn Khaldun's thoughts as a solution to the ethical issues. The user assessment has provided details on the degree of ontology usefulness of the developed ontology for ethical issues in SNS based on Ibn Khaldun's thoughts.

FINDINGS

Any formality has been incorporated into this analysis for ontology evaluation by using criteria proposed by Degbelo (2017) and Kreider (2013) to which the ontology relation must be evaluated. Below are the ontology evaluation criteria:

1. **Comprehensive:** The number of concepts in the ontology could be extended with regards to ethical issues in SNS related to Ibn Khaldun's thought (Kehagias et al., 2008).
2. **Ease of Use:** The ontology can be understood, navigated, and implemented on the related elements including the terms, concepts, and the overall developed ontology.
3. **Adaptability:** The ontology allows the possibility of adding new definitions. The requirement to add new information to a definition does not affect or need alteration to the set of well-defined properties that are already guaranteed after the ontology's verification process (Asuncion Gomez-Perez et al., 1995).
4. **Coherence:** The ontology does not include or allow for any contradictions. This refers to whether it will have contradictions from valid input data (Asuncion Gomez-Perez et al., 1995).
5. **Competency:** The completeness of an ontology cannot be proven based on the completeness of its definitions. However, only the incompleteness of an individual definition can be proven. If the entities can be inferred from other definitions and axioms it is complete, otherwise, it is incomplete (Asuncion Gomez-Perez, 2004).
6. **Accuracy:** This is when the criterion for determining is the asserted knowledge in the ontology agrees with the expert's knowledge about the domain. A higher accuracy will typically result from correct definitions and descriptions of classes, properties, and individuals. (Hlomani Hlomani & Deborah Stacey, 2014).
7. **Clarity:** Measures how effectively the ontology communicates the intended meaning of the defined terms (Hlomani Hlomani & Deborah Stacey, 2014).
8. **Consistency:** This is when the concepts and relations are defined consistently. Consistency is proven if any concept in the ontology is only defined by its own relationships with others (Gómez-Pérez et al., 2004).

9. **Completeness:** Focuses on whether enough concepts of the ontology were generated to represent the target subject areas adequately. In generic terms, completeness evaluation shows how “good” the coverage of the domain ontology has (Ascuncion Gomez-Perez, 2004).
10. **Conciseness:** This refers to if all the information gathered in the ontology is useful and precise. It doesn't imply the absence of redundancies (Asuncion Gomez-Perez et al., 1995).

RESULTS

The evaluation process was established to verify the semantic relationship and validate the usefulness of ontology on ethical issues in SNS based on Ibn Khaldun's thoughts.

Validation

The validation results from the chosen experts that have been appointed to evaluate the main concepts within ontology for ethical issues in SNS and Ibn Khaldun's thoughts.

Validation by experts from the Information Technology Department

The list of concepts assigned for Ibn Khaldun's thoughts and tweets were finalized after the experts checked the concepts are met all the list of criteria: *Comprehensive, Ease of Use, Adaptability, Coherence, Competency, Accuracy, Clarity, Consistency, Completeness* and *Conciseness*. However, in the validation process, the expert highlighted three criteria: *Comprehensive, Competency* and *Completeness* with the remarks 'difficult to confirm'. It is because they felt that the ontology concepts must be viewed to have a deep understanding of Ibn Khaldun's thoughts and validated the ontology concepts fulfilled the selected criteria.

Validation by experts from the Human Sciences Department

The results from the validation task by experts met all the lists of criteria of being *Comprehensive, Ease of Use, Adaptability, Coherence, Competency, Accuracy, Clarity, Consistency, Completeness* and *Conciseness*. The expert commented that the concepts assigned for Ibn Khaldun's thoughts and Twitter tweets were 'compliant' for whole criteria in the lists. Their remarks were: "Ibn Khaldun's thoughts are explained by its various sources and domain of human activity his ideas, and therefore his thoughts can be applied", "Ibn Khaldun's thoughts are very practical and different from philosophy which he declared at the beginning of his *Muqaddimah*", "His thoughts were flexible and could be adapted by making new interpolations and his concepts could be applied for new situations", "His access to references, facts and records provided him with a high level of accuracy" and "Ibn Khaldun built his concepts and connected them in such a fine and precise manner that they moved towards one direction measured by *Tawhid*".

Verification

The verification results from the chosen experts that have been appointed to confirm whether the tweets statements under the study were positive, neutral, or negative in nature and to verify Ibn Khaldun's thoughts related to tweets.

Verification by experts from the Information Technology Department

In task 1, the experts verified the suitability of concepts assigned for Ibn Khaldun's thoughts and tweets from Twitter. They found that all concepts assigned for Ibn Khaldun's thoughts and tweets for Twitter met all the themes or concepts assigned for each class in Protégé. Only two concepts found 'inaccurate' for the subclasses within the concept assigned for tweets from Twitter because the relationship of the concepts assigned to the subclass was not clear. Therefore, the concepts need to be rechecked. The other lists prepared were found to be acceptable. Meanwhile, expert number two confirmed the accuracy of all listed concepts assigned for Ibn Khaldun's thoughts and tweets for Twitter.

Likewise, the experts reviewed the correctness of concepts for Ibn Khaldun's thoughts related to tweets and the description of Ibn Khaldun's thoughts for each subclass in task 2, They thoroughly checked the categorization table of tweets and matched them against the related Ibn Khaldun's thoughts in the verification form. The results showed that the concepts carried either negative statements (List A), positive statements (List B) or neutral statements (List C) which indicates that not all the themes or concepts assigned for each subclass in Protégé are arranged accordingly.

As a result, the experts marked List A and List B and commented some of the theme as 'not clear' and recommended that the incorrect categories to be rechecked so that they can be re-categorized with the correct class of concepts. Both experts, therefore, agreed that the tweets categorized under neutral statements in List C should remain and be maintained under an independent category that is neutral and no need to be combined with positive statements. Thus, the tweet categories were revised based on all recommendations provided by the experts and were finalized after consultation with the supervisory committee for the final decision.

Verification by experts from the Human Sciences Department

In task 1, the experts provided their opinions on the suitability of concepts assigned for Ibn Khaldun's thoughts with the proposed subclasses. The results showed that the suitability of concepts assigned for Ibn Khaldun's thoughts for each of the subclasses in Protégé was comprehensively analyzed by experts. Most of the assigned concepts were considered accurate with the proposed subclasses. The experts suggested that the subclasses be replaced with another word that is more direct to represent the concepts. For example, they suggested several concepts assigned for Ibn Khaldun's thoughts be renamed as follows: 'Social Integration' to 'Social Cohesion', 'Excellent' to 'Piety', 'Great' to 'Excellence', 'King' to 'Ruler' and 'Politic' to 'Institutions Administration'. These suggestions were to use Ibn Khaldun's idea from his discourse and get closer to understanding the assigned concepts. The suggested concepts were revised as recommended by the experts and approved by the supervisory committee for adoption.

For task 2, the experts reviewed the correctness of the description of Ibn Khaldun's thoughts for each subclass. As a result, the descriptions which have been assigned for Ibn Khaldun's thoughts classes were found to be correct and met all the themes or concepts assigned. However, although the description of Ibn Khaldun's thoughts for each subclass were correct, they needed to be detailed to describe each of the concepts presented. Experts believed that they required to have a correct idea of Ibn Khaldun's concepts so that they could be more precise in choosing the descriptions for each concept. This meant that they needed to review the descriptions of the suggested topics so that they have a clear picture of Ibn Khaldun's ideas. The description assigned for each subclass were revised according to Experts' commentaries and were accepted after endorsement by the supervisory committee.

Formalization of competency questions in SPARQL query

Results from the execution of formalised one hundred and forty-six (146) competency questions were generated through the SPARQL query. The query could be understood by the SPARQL engine using query generator and pattern heuristic. SPARQL's role was to produce results based on the knowledge available in the ontology that is related to Ibn Khaldun's thoughts and tweets. These results were from the classes that have the ethical issues related to tweets statements. The SPARQL query results produced were followed by discussions and accompanied by visualisation in Onto Graf. All the relationships within the ontology semantic relationship have been verified and reviewed by the experts during the evaluation stage before being constructed in the SPARQL query. The successful execution of formalised competency questions conducted in the SPARQL query indicated the capability of ontology in answering the prepared questions that suited the purpose of the ontology. This is the example of formalisation of competency question in SPARQL query:

Competency Question 1: What are the ethical issues in SNS related to the caliphate?

This question was successfully answered by assessment of exhibit three results from the SPARQL query execution. Figure 2 shows the result from the execution process for ethical issues in SNS related to the caliphate. Hierarchically, multiple suggested Ibn Khaldun's thoughts corresponding to these ethical issues were grouped as follows: the instance for 'Quality of Human Resources' class below the subclass of 'Awareness Society', the instance for 'Holistic Governance' class below the subclass of 'Great Scholars' and the instance for 'Khilafah Governance System' class below the subclass of 'Good Governance/ Khalifah'. The entire subclass had been categorized under the main subclass of Ibn Khaldun's thoughts. From Twitter, ethical issues from the tweet's statements 'eugh shameless Claim yourself government and others as the opposition' is the instance for 'NGovernment' which is class below the 'Government' subclass under the 'Good Governance/ Khalifah' class that is under the main class of Twitter Tweets.

```
PREFIX rdf: <http://www.w3.org/1999/02/22-rdf-syntax-ns#>
PREFIX owl: <http://www.w3.org/2002/07/owl#>
PREFIX rdfs: <http://www.w3.org/2000/01/rdf-schema#>
PREFIX xsd:
<http://www.w3.org/2001/XMLSchema#>
PREFIX snsik: http://www.semanticweb.org/ibnkhaldun/ontologies/2018/1/untitled-ontology-9#

SELECT? object

WHERE
{snsik:eugh_shameless_Claim_yourself_government_and_others_as_the_opposition
snsik:areEthicalIssues?object}
```

Figure 2. Execution Result from Competency Question 1 in SPARQL Query

As a result, the instance for Quality of Human Resources can be defined as 'When mankind has achieved social organization, as we have stated, and when civilization in the world has thus become a fact, people need someone to exercise a restraining influence and keep them apart, for aggressiveness and injustice are in the animal nature of man. The person who exercises a restraining influence, must dominate them, and have power and authority over them so that no one of them will be able to attack another. This is the meaning of royal authority. It has thus become clear that royal authority is a natural quality of man which is necessary to mankind'.

For the instance of Holistic Governance, it can be described as ‘The caliphate is a kind of great mainspring and comprehensive basis, and all these functions are branches of it and fall under it because of the wide scope of the caliphate, its active interest in all conditions of the Muslim community, both religious and worldly, and its general power to execute the religious laws relative to both religious and worldly affairs’.

Lastly, the instance of Khilafah Governance System can be identified as ‘The caliph is the guardian and trustee of the Muslims. He looks after their affairs if he lives. It follows that he should also look after their affairs after his death, and therefore, should appoint someone to take charge of their affairs as he had done while alive, whom they can trust to look after them as they had trusted him then’.

In the Onto Graf visualization, the results visualized are matched with the findings produced from SPARQL Query. Brown links pointed to multiple of Ibn Khaldun’s thoughts indicating the ‘areEthicalIssues’ relationship between Twitter tweets to the recommended Ibn Khaldun’s thoughts. While the yellow links inversely indicated the ‘hasEthical’ relationship from Ibn Khaldun’s thoughts to the ethical issues in Twitter tweets as depicted in Figure 3.

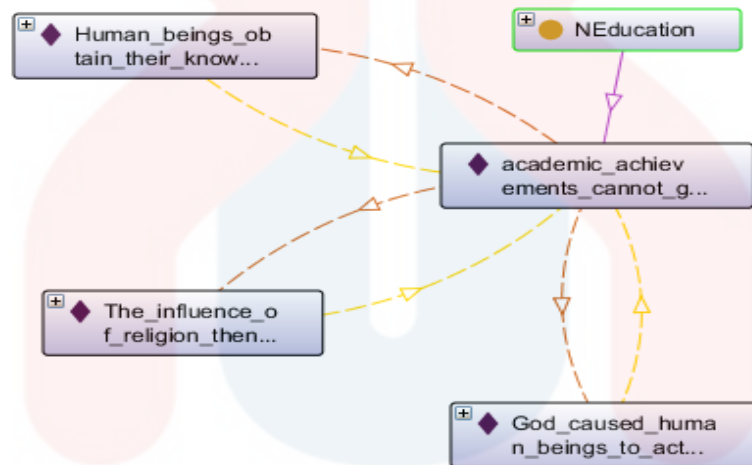

Figure 3. Onto Graf Visualization for Competency Question 1 and Its Corresponding Ibn Khaldun’s Thoughts

User assessment

Three users have been appointed who are the same experts and who had previously been appointed to determine the suitability of the items resulting from ontology executed via the SPARQL Query. The user assessment form listed the overall results of the ethical issues of tweets on Twitter and the possible Ibn Khaldun’s thoughts. Users rated the suitability of the generated ethical issues from tweets on Twitter and their relationship with Ibn Khaldun’s thoughts as Suitable or Not Suitable. One hundred and forty-six (146) tweets originating from 1075 public tweets have been collected which include only negative sentiments that have been listed to be evaluated in the user assessment form.

Out of the 372 Ibn Khaldun’s thoughts that have been assigned to ethical tweets, there are 231 equivalents to 62% of the range of the results which have been classified as Suitable. For clarity, user 1 rated 21 results equal to an average of 2% for the suitability of the ethical issues generated by Twitter tweets and their relationship with Ibn Khaldun’s thoughts. A further 320 equivalents to 29% of the results were categorized as Suitable by user 2 and user 3 rated 351 suitability results equal to 31%. Figure 6 demonstrates the results of the suitability of the user assessment form in a line table.

Another 130 equals 35% of the results were categorized as Not Suitable and 11 results equivalents to 3% were categorized as Unanswered by the users in the assessment form. Therefore, most of Ibn Khaldun’s thoughts provided by the ontology as a solution to the ethical issues of tweeting have achieved a suitability level of ontological usefulness from the point of view of users. Table 2 outlined the overall results and details of the user assessment.

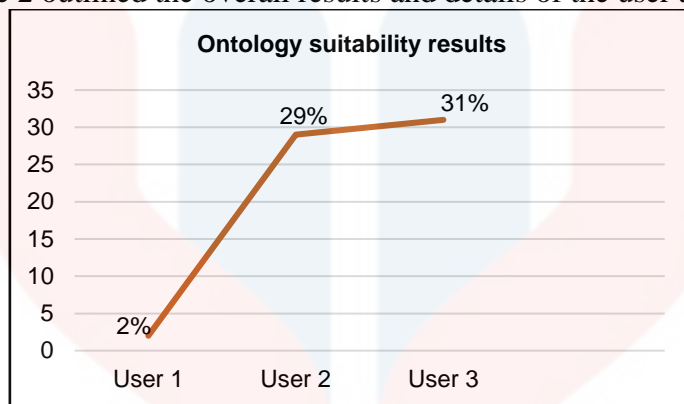

Figure 6. Graphical Results of User Assessment on Ontology Suitability (%)

Table 37. Results of The User Assessment Process

The users	Ethical issues from tweets	Ibn Khaldun’s thoughts	Percentage of suitability		
			Suitable	Not suitable	Unanswered
3	146	372	231	62%	
			130	35%	
			11	3%	

Users clarified in their remarks that the rate for the majority of Ibn Khaldun’s thoughts as Suitable with the related tweets is due to their relevance and appropriateness as a solution to the ethical issues as well as to the acceptable matching correlation between thoughts and issues. However, users assume that Ibn Khaldun’s thoughts rated as Not Suitable had a positive significance category but are not relevant to the ethical issues appointed which are retrieved from Twitter and the thoughts not specifically mentioned for use to the issues. The same remarks were made to the Not Suitable because the ethical issues are too general in meaning and they do not thoroughly comprehend some of the messages of the tweets.

Accordingly, some of the users mentioned the need to find someone who understands well Ibn Khaldun's ontology to simplify the ontology and match it with the classified tweet that has been done under Ibn Khaldun's ontology. For Unanswered tweets, users remark that Ibn Khaldun's thoughts have the same ideas as other thoughts. As an example of the ‘Creed’ thoughts, one of the users points to the same interpretation of the ‘Tawhidic Application’ class. Other reasons that they are suggested in making the form easier for them to understand the intent of Ibn Khaldun’s thoughts since they are not a domain expert in the field of Ibn Khaldun but in the field of ontology.

In terms of additional suggestions for future work, users are eager to look forward to this ontology being incorporated in the system based. The availability of the system offers them an opportunity to identify the suitability between Ibn Khaldun's thoughts as supporting for the ethical issues in SNS. Users from different areas of experience supported the idea of involving Ibn Khaldun's thoughts as a support to the ethical issues retrieved in Twitter. Moreover, the suitability of Ibn Khaldun's thoughts depended mainly on the context of the current issues and situations discussed by users in the SNS. Figure 7 displays the overall outcome of the user assessment form in a bar chart.

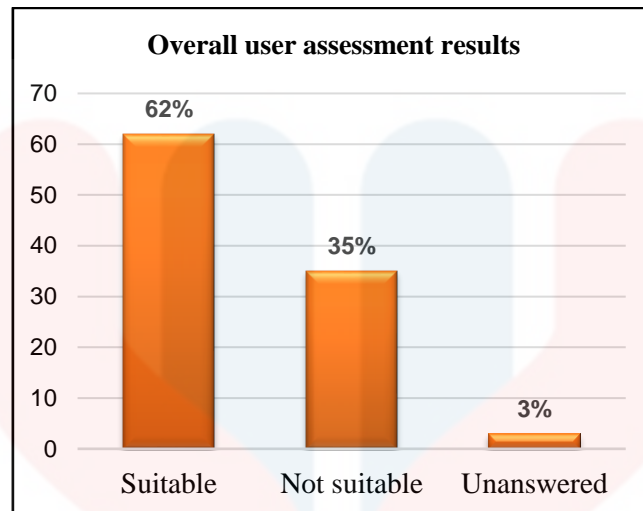

Figure 11. Graphical Results of User Assessment Results

CONCLUSIONS

The evaluation results and the content had been validated and verified by the experts. Their comments were reviewed, and remarks were made in line with their suggestions. The ontology for ethical issues in SNS based on Ibn Khaldun's thoughts had been successfully developed with expected outcomes for this research. Thus, the ontology evaluation phase has captured the explicit and implicit knowledge since it received good remarks and suggestions from the experts. Its development phase provided the ontology model for ethical issues in SNS based on Ibn Khaldun's thoughts containing classes and subclasses, instances, object properties and semantic relationships between them.

Likewise, in the evaluation procedure for the developed domain, this research has contributed to the ontology evaluation procedure consisting of validation, verification, SPARQL Query execution and user assessment. Some evaluation criteria were added to enable successful test input for the ontology domain for ethical issues in SNS and Ibn Khaldun's thoughts. Three experts contributed their expertise in the validation and verification process at the ontology evaluation stage and one hundred and forty-six (146) sets of competency questions for validation of their ontological relationship matched in SPARQL Query execution. Furthermore, the user assessment showed positive results on the benefits of the generated Ibn Khaldun's thoughts for ethical issues in Tweets. All these processes make it possible for the built ontology to be tested successfully.

Theoretically, the remarks and justification by the experts were good references to prove that human justification for relevance frequency is different from system application generated relevance feedback. In this regard, the validate ontology model can be used as a guideline to expand in a wider dimension of concepts. This ontology development is therefore important and may improve the relevance in searching and retrieving structured information by researchers.

ACKNOWLEDGEMENTS

This research was supported by the Fundamental Research Grant Scheme (FRGS/1/2018/ICT04/ UIAM/02/2) Research Project 19-037-0645 provided by the Ministry

of Education Malaysia (MOE). The authors also would like to acknowledge the Kulliyyah of Information and Communication Technology, International Islamic University Malaysia and the Islamic Science University of Malaysia for their support.

REFERENCES

- Alsanad, A. A., Chikh, A., & Mirza, A. (2019). A Domain Ontology for Software Requirements Change Management in Global Software Development Environment. *IEEE Access*, 7, 49352–49361. <https://doi.org/10.1109/ACCESS.2019.2909839>
- Bansal, R., & Chawla, S. (2016). Evaluation Metrics for Computer Science Domain Specific Ontology in Semantic Web Based IRSCSD System. *Perspectives in Science*, 4523, 129–139. <https://doi.org/10.1016/j.pisc.2016.04.067>
- Brank, J., Grobelnik, M., & Mladenić, D. (2005). A survey of ontology evaluation techniques. *Proceedings of the Conference on Data Mining and Data Warehouses*, 166–170. <https://doi.org/10.1.1.101.4788>
- Degbelo, A. (2017). A Snapshot of Ontology Evaluation Criteria and Strategies. *Proceedings of Semantics*, 11–14. <https://doi.org/https://doi.org/10.1145/3132218.3132219>
- Fox, M. S., Barbuceanu, M., Gruninger, M., & Lin, J. (1998). An Organization Ontology for Enterprise Modelling. *Simulating Organizations: Computational Models of Institutions and Groups*, 131–152. [https://doi.org/10.1016/0166-3615\(95\)00079-8](https://doi.org/10.1016/0166-3615(95)00079-8)
- Gangemi, A., Catenacci, C., Ciaramita, M., & Lehmann, J. (2006). Modelling ontology evaluation and validation. *Lecture Notes in Computer Science (Including Subseries Lecture Notes in Artificial Intelligence and Lecture Notes in Bioinformatics)*, 4011 LNCS, 140–154. https://doi.org/10.1007/11762256_13
- Gómez-Pérez, A., Fernández-López, M., & Corcho, O. (2004). *Ontological Engineering: with examples from the areas of Knowledge Management, e-Commerce and the Semantic Web*. Springer.
- Gomez-Perez, Ascuncion. (2004). Ontology Evaluation. In Steffen Staab & R. Studer (Eds.), *Handbook on Ontologies in Information Systems* (pp. 251–274). Springer, Berlin.
- Gomez-Perez, Asuncion, Juristo, N., & Pazos, J. (1995). Evaluation and Assessment of the Knowledge Sharing Technology. *Towards Very Large Knowledge Bases*, IOS Press, 289–296.
- Gruber, T. R. (1995). Toward principles for the design of ontologies used for knowledge sharing. *International Journal Human Computer Studies*, 43, 907–928.
- Grüninger, M., & Fox, M. S. (1995). *The Role of Competency Questions in Enterprise Engineering*. August 2013, 22–31. https://doi.org/10.1007/978-0-387-34847-6_3
- Halawi, B., Mourad, A., Otrok, H., & Damiani, E. (2018). Few are as good as many: An ontology-based tweet spam detection approach. *IEEE Access*, 6, 63890–63904.
- Hlomani Hlomani, & Deborah Stacey. (2014). Approaches, methods, metrics, measures, and subjectivity in ontology evaluation: A survey. *Semantic Web Journal*, 1(5), 1–11.
- Izhar, T. A. T., Torabi, T., & Ishaq Bhatti, M. (2017). Using ontology to incorporate social media data and organizational data for efficient decision-making. *International Journal of Computer Information Systems and Industrial Management Applications*, 9(2017), 9–22.
- Kehagias, D. D., Papadimitriou, I., Hois, J., Tzovaras, D., & Bateman, J. (2008). A methodological approach for ontology evaluation and refinement. *ASK-IT Final Conference*. June.(Cit. on P.), October, 1–13.
- Kreider, R. G. (2013). *An Ontology of the Uses of Building Information Modeling* (Issue December). <http://gradworks.umi.com/35/85/3585592.html>

- Najid, M. H. M., Zulkifli, Z., Othman, R., Rokis, R., & Salahuddin, A. A. (2021). Identifying the Ethical Issues in Twitter: A Knowledge Acquisition for Ontology. *Malaysian Journal of Computer Science. Information Retrieval and Knowledge Management Special Issue*, 2, 101–115.
- Nefzi, H., Farah, M., Farah, I. R., & Solaiman, B. (2014). A Critical Analysis of lifecycles and Methods for Ontology Construction and Evaluation. *1st International Conference on Advanced Technologies for Signal and Image Processing -ATSIP'2014*, 48–53.
- Vrandeic, D. (2009). Ontology Evaluation. In S. Staab & R. Studer (Eds.), *Handbook on Ontologies* (pp. 293–313). <https://doi.org/10.1007/978-3-540-92673-3>
- Wagih, H. M., & Mokhtar, H. M. O. (2016). HBTOnto: An Ontology Model for Analyzing Human Behavior Trajectories. *Proceedings - 2015 11th International Conference on Semantics, Knowledge and Grids, SKG 2015*, 126–132.
- Yu, J., Thom, J. A., & Tam, A. (2005). Evaluating ontology criteria for requirements in a geographic travel domain. *Lecture Notes in Computer Science (Including Subseries Lecture Notes in Artificial Intelligence and Lecture Notes in Bioinformatics)*, 3761 LNCS, 1517–1534. https://doi.org/10.1007/11575801_36
- Zheng, L. (2017). SNSQ ontology: A domain ontology for SNSs data quality. *2017 2nd IEEE International Conference on Cloud Computing and Big Data Analysis, ICCCBDA 2017*, 11–18. <https://doi.org/10.1109/ICCCBDA.2017.7951876>.



Teaching Arabic Grammar Using Tree View Representation

Ahmed Abdelghany Mohammed

Linguistic Studies Department, Universiti Malaysia Kelantan, Malaysia

Abdelghany.ma@umk.edu.my

Ahmad Abdul Rahman

Linguistic Studies Department, Universiti Malaysia Kelantan, Malaysia

Ahmad.ar@umk.edu.my

ABSTRACT

This research aims to teach the basics of Arabic syntactic analysis for native and non-native speakers of Arabic. In this research, we apply the structural linguistic approach through employing a tree viewer application called PALMYRA 2.4 (a platform-independent graphical tool for syntactic dependency annotation supporting languages that require complex morphological tokenization.) in teaching sentence analysis. PALMYRA is configured to be compatible to any dependency parsing representation, and to enable annotating many different linguistic features. It uses an interface that relies on drag-and-drop utilities.

Keywords: *syntactic analysis, Palmyra tool, Arabic language, POS tags, syntactic relations*

INTRODUCTION

Arabic syntax is a challenging area in Arabic language sciences for native speaker learners, as well as non-native learners. This is because syntactically, Arabic language is a free word-order language, opposed to fixed-word order languages like English. At the morphology level, Arabic is morphologically rich and highly ambiguous, it has a complicated system of morphology characterized by affixational morphemes and complex morphological rules. Missing diacritization in Arabic written materials makes the analysis process more challenging. One of the main reasons that help in syntactic analysis of Arabic sentences is understanding the meaning from the context and from the non-linguistic background, that is why ancestors argued that “E’rāb (syntactic analysis) is meaning”, and that is why Automatic processing of Arabic is challenging.

Recently, learning Arabic has begun to gain more attention among learners across the Islamic world as well as the Western world. The Arabic language has shifted from the language of Islam only to being widely recognized as an international language. Thus, there has been an urgent need to innovate pedagogical approaches to teach Arabic grammar

What non-native speakers of the Arabic language need is to recognize the boundaries of different Arabic structural syntactic components and their functions, so, the system of “E’rāb” with tree viewer is the most appropriate and effective way that serves their needs.

There are many grammatical representations that differ in terms of the linguistic theories on which they are based. One of these is the Universal Dependency representation (UD) (Nivre et al., 2016) that is applicable in a lot of languages. It is one of the most popular representations. The Penn Treebank representation (PTB) (Marcus et al., 1993) makes use of a constituency representation that is rich with morphological features. Many languages, including Arabic (Maamouri et al., 2003), English (Marcus et al., 1993), and Chinese (Xue et al., 2005) use this representation in syntactic analysis. PTB representation is very convenient to constituency parsing. The Prague Dependency Treebank (PDT) (Böhmová et al., 2003) is a

representation used for annotating treebanks in Arabic (Hajic et al., 2004) and Czech (Böhmová et al., 2003).

Advantages of PALYMRA

- It runs on all hardware platforms or software architectures (platform-independent).
- It is easy to install.
- It can be used offline.
- It is lightweight.
- It is open-source.
- It is easy to use (requires minimal training).
- It lists all the trees sentences to be easily searched and displayed.
- It supports rich-morphology languages (like Arabic).
- It allows drag-and-drop in assigning POS tags and syntactic relations, and has the options of using both shortcut keys and buttons.
- It allows the user to make tokenization by splitting and merging nodes in the displayed trees.
- It introduces an adaptable configuration file that allows the user to configure the list of the syntactic relations and part of speech tags used in the representation.
- It can be extended to annotate other morphological features that go beyond POS tags and syntactic relations.

Related Work

Many representation softwares have been developed in the context of syntactic analysis and morphological analysis. Most of these tools were created for natural language processing (NLP) purposes to improve automatic syntactic and morphological analysis. None of these tools were developed for language learning purposes. TrEd (Pajas and Tepánek, 2008), EasyTree (Little and Tratz, 2016), ConlluEditor, and the Quran corpus tree viewer tool are all examples of these representation softwares.

TrEd is a graph visualization software written in Perl. It has been used in many treebank projects including Prague Arabic Dependency Treebank (Hajic et al., 2004) and Columbia Arabic Treebank (CATiB) (Habash and Roth, 2009). The limitations of TrEd are that it is a standalone software and cannot be run through a web browser. In addition to it does not have a simple option for word tokenization. Also, it is difficult to install and learn.

EasyTree (Little and Tratz, 2016) is a light-weight software developed for annotating dependency trees in browsers. PALMYRA is developed on the base of it. One of the limitations of this tool is that it doesn't support word tokenization. Also, it does not maintain sentence order of nodes.

ConlluEditor tool (Heinecke, 2019) is a fully graphical editor for manual annotation. It allows editing morphological features and syntactic relations. It has the functionality for merging and splitting words. Also, it displays multi-word tokens and empty nodes. One of its limitations is that it uses a client-server architecture.

Quran corpus tree viewer tool (Kais Dukes and Tim Buckwalter, 2010) is used in annotating the Quranic Arabic dependency treebank (QADT) and displaying Quran verses using dependency graphs. These graphs show how each word is related in the Quran verse and what syntactic role it plays in building up a complete syntactic tree. Quran corpus is an Arabic annotated linguistic resource presents the morphology and the syntactic role for each word in the Quran. It provides three levels of analysis: [morphological annotation](#), a [syntactic treebank](#) and a [semantic ontology](#). Each word of the Quran is tagged with its part-of-speech and several

morphological features. The grammar framework adopted by the Quran Corpus is the traditional Arabic grammar of *i'rab* (إعراب).

The Linguistic Framework

PALMYRA takes a configuration file as an input. The configuration file specifies the various configuration and annotation options for the tool. The most important use of the config file is to specify the inventory of POS tags available for morphological tagging process, and the syntactic relations available for syntactic tagging process. One of the main advantages of PALMYRA tool is that it allows users to define their own morphological tag set and syntactic relations. In this way, user can propose different syntactic representations and can control the depth of the morphological and syntactic analysis.



Figure 1: POS Tags and syntactic relations

Part-Of-Speech (POS) Tags

There are three main POS tags in the traditional Arabic grammar classification. These are noun, verb and particle. Each of these main POS tags can be divided into many subordinate classes according to morphological and semantic considerations.

Subordinate classes include:

Interrogative nouns (أسماء الاستفهام): like (كم - كيف - أين - متى - ماذا - ما - من - أيان - أنى)

Deverbal nouns (اسم الفاعل - اسم المفعول - المصادر): nouns that are derived from verbs or verb phrases, but that behave grammatically purely as nouns, not as verbs. However, in some cases it may be a head of subject or object.

Pronouns (الضمائر) include:

Implicit pronouns (الضمير المستتر) which, in turn, include:

Compulsory Implicit (واجب الاستتار): in cases of present verb referring to 1st person pronoun (I write " - "نكتب"we write "نكتب"), present verb referring to 2nd person masculine singular pronoun (you [sg-mas] write "تكتب (أنت)"), and imperative referring to 2nd person masculine singular pronoun (write {you[sg - mas]} اكتب).

Optionally Implicit (جائز الاستتار): includes any other cases than compulsory implicit.

Prominent pronouns (الضمير الظاهر) which, in turn, include:

Attached pronouns (الضمير المتصل) which include:

Object pronouns (ضمائر المفعول) that include:

1st person (ي - نا)

2nd person (ك - كما - كنّ - كن)

3rd person (ه - ها - هما - هم - هنّ)

Subject pronouns (ضمائر الفاعل) which include 1st person pronouns (ت - نا), 2nd person pronouns (ت - ت - تما - تم - تنّ - ين - ي), and 3rd person pronouns (ون - وا - ن).

Detached pronouns (الضمير المنفصل) which include:

Accusative pronouns (ضمائر النصب) which, in turn, include:

1st person (إياي - إيانا),

2nd person (إياك - إياكم - إياكنّ - إياكن)

3rd person (إياها - إياهما - إياهم - إياهنّ)

Nominative pronouns (ضمائر الرفع) which, in turn, include:

1st person (أنا - نحن)

2nd person (أنت - أنت - أنتما - أنتم - أنتنّ)

3rd person (هو - هي - هما - هم - هنّ)

Proper nouns (اسم علم): the names of a particular persons, countries, places, [organizations](#), or things.

Verbal nouns (أسماء الأفعال) include:

Present verbal nouns (أف أوه - وي - بخ)

Past verbal nouns (هيهات - شتان - سرعان)

Imperative verbal nouns (هيّا - مكاتك - أمامك - عليك - دونك - رويدك - هلمّ - حيّ - أمين - صه - هاؤم)

Relative pronouns (الذي - التي - اللذان - اللتان - الذين - اللاتي - ما)

Demonstrative pronouns (هذا - هذه - هذان - هاتان - هؤلاء - أولئك)

Conditional conjunctions (إذا - من - ما - أينما - متى - أين - أئى - كيفما)

Interrogative pronouns: (مَن - ماذا - متى - أين - كيف)

Adverbs: (أمام - خلف - وراء - فوق - تحت - قبل - بعد - الآن - يسار - يمين)

Verb (فعل): a content word that has a meaning itself and is associated with time. Subordinate classes include:

Past verbs (الفعل الماضي)

Present verbs (الفعل المضارع)

Imperative verbs (فعل الأمر)

Passive voice verbs (صيغة البناء للمجهول في الأزمنة الثلاثة)

Verbal infinitive (المصدر المؤوّل): a combination of "أن + الفعل المضارع" or "ما + الفعل الماضي"

Incomplete verbs (الأفعال الناقصة) which include:

Kana and its sisters (كان - أصبح - أمسى - ظل - بات - مازال - ما برح -...): (كان وأخواتها)

Kada and sisters (كاد - أوشك - كرب - عسى - طفق - بدأ - شرع -...): (كاد وأخواتها)

Particle: a stop word that has no meaning in itself, but it gets its meaning from the surrounding context. Subordinate classes include:

Verb-like particles (الحروف المشبهة بالفعل): (إنّ - أنّ - كأنّ - لبت - لعل).

"لا" as a verb-like particle (لا النافية للجنس)

Negation particles (لا - لن - لم - ليس)

- Conditional particles (لو- لولا - لوما - إن)
- Vocation particles (يا - أ - أيا - هيا - أي)
- Prepositions (عن - على - في - إلى - ب - في)
- Exception particle (إلا)
- Interrogative particles (هل - أ)
- Coordinating Conjunction (و - ثم - أو - ف)
- Infinitive particles (الحروف المصدرية): they precede verbs to combine an indirect Verbal infinitive structure (ما - أن).
- Other particles (سوف - قد - سد - أمّا - إمّا

Syntactic Relations

Performing syntactic analysis in the dependency framework involves two inter-related steps: attachment and labeling (Žabokrtský and Smrž, 2003; Habash and Rambow, 2004; Habash et al., 2007; Smrž et al., 2008; Tounsi et al., 2009). The attachment indicates that there is a syntactic relationship between two words, “the head word” (or governing) and “the dependent word” (or governed). The labeling specifies the type of each attachment by assigning “labels” or “relations” for each attachment. For example, the “subject” relation may label the attachment of a dependent noun to a heading verb, where the noun is the subject of the verb. This section provides a review of the different syntactic relations used in learning basics of Arabic syntactic analysis textbook. These relations can be divided into five categories (Nominative relations - Accusative relations - Genitive relations – modifiers – subordinate clauses)

Nominative Relations

Active subject (الفاعل)	It marks the explicit syntactic active subjects of verbs
Passive subject (نائب الفاعل)	It marks the explicit syntactic passive subjects of verbs
Subject-predicate (خبر المبتدأ)	It marks the predicate of the subject regardless it appears before or after the subject
Subject of incomplete verbs (اسم كان وأخواتها)	It marks the subject of incomplete verbs (كان ما الحجازية -كاد وأخواتها -وأخواتها)
Predicate of verb-like particles (خبر (إن وأخواتها)	It marks the predicate of verb-like particles (إن (لا النافية للجنس-وأخواتها)

Table 1: the nominative syntactic relations and their references

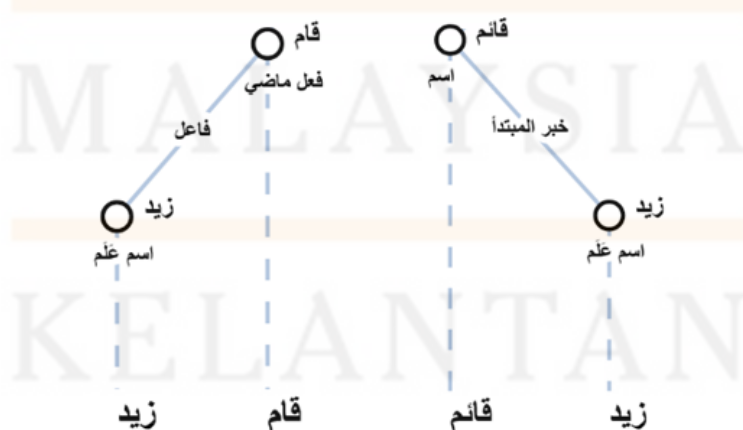

Figure2: Examples of nominative syntactic relations (Active subject "الفاعل" - Subject-predicate "خبر المبتدأ")

Accusative Relations

Direct Object (المفعول به)	It marks the object of verbs and deverbal nouns
Absolute object (المفعول المطلق)	It marks the verbal noun (in the accusative form) that serves to emphasize the meaning of the main verb
Causative object (المفعول لأجله)	It marks the relation between the verb and the noun referring to the cause of doing this verb
Specification (التمييز)	It marks the specifier in the specification construction
Adverb (الحال)	It marks the noun that modifies a verb, and gives extra information about the manner of doing this verb
Subject of verb-like particles (إن وأخواتها) (اسم إن وأخواتها)	It marks the subject of verb-like particles (إن وأخواتها) (لا النافية للجنس)
Predicate of incomplete verbs (كان وأخواتها) (خير كان وأخواتها)	It marks the predicate of incomplete verbs (كان وأخواتها) (ما الحجازية - كاد وأخواتها -

Table 2: the accusative syntactic relations and their references

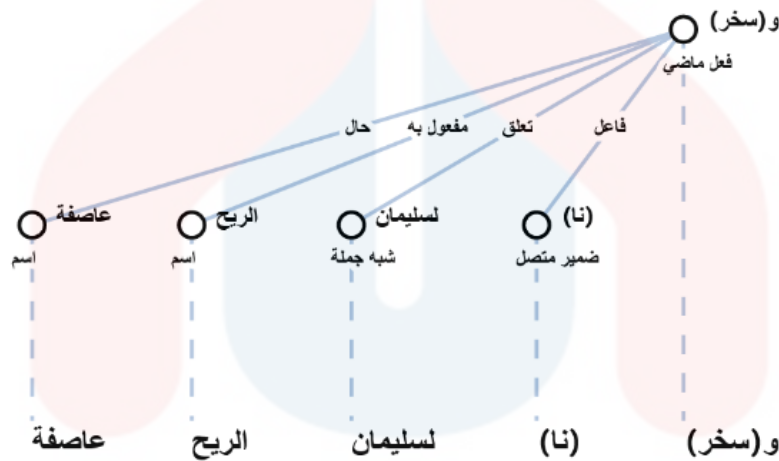

Figure 3: Examples of accusative syntactic relations (Direct object "المفعول به" – Adverb "الحال")

Genitive Relations

Possessive construction (الإضافة)	It marks the possessor in an "Edafa" construction.
Genitive noun (الجار والمجرور)	It marks the relation between the preposition and the following genitive noun (الاسم المجرور).

Table 3: the genitive syntactic relations and their references

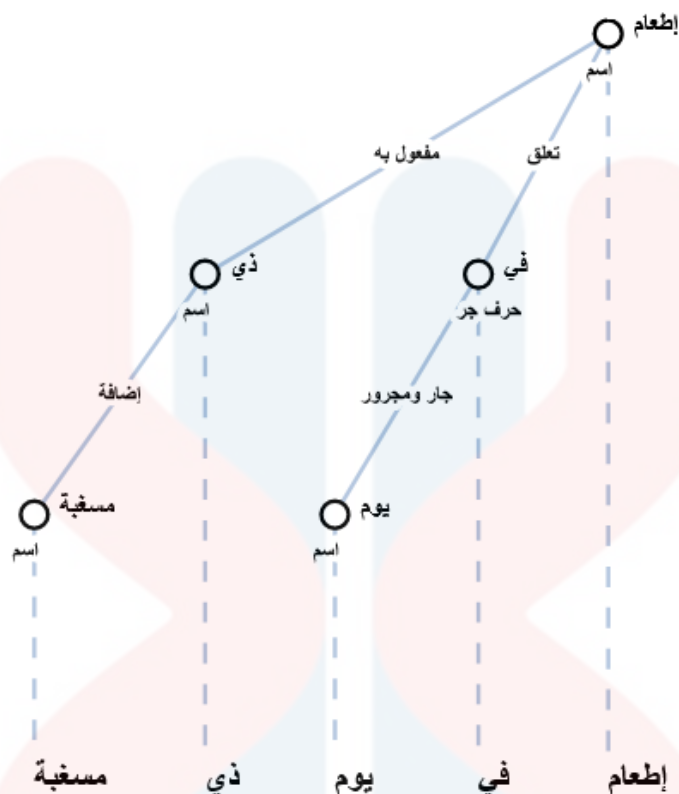

Figure4: Examples of genitive relations
 ("جار ومجرور" – "إضافة" – Genitive noun "إطعام ذي مسغبة")

Modifiers

They refer to nouns that follow the preceding word in case ending and other morphological features. There are four modifiers in Arabic language, they are:

- Adjectival modification
- Apposition modification
- Emphasis modification
- Coordinating conjunction

Subordinate Clauses

Condition clause (جملة الشرط)	It marks the relation between the condition particle and the condition clause after it
Condition-consequence clause (جواب الشرط)	It marks the relation between the condition particle and the consequence clause.
Oath clause (جملة القسم)	It marks the relation between the oath particle and the oath clause after it
Oath-consequence clause (جواب القسم)	It marks the relation between the oath particle and the oath-consequence clause
Relative clause (جملة الصلة)	It marks the relation between the relative pronoun and the relative clause
Parenthetical clause (الجملة الاعترافية)	It marks the relation between the head of the main sentence and the Parenthetical clause
Attachment clause (شبه الجملة المتعلق)	It marks the relation between the verb and the prepositional phrase attached to it

Table 4: subordinate clauses with their references

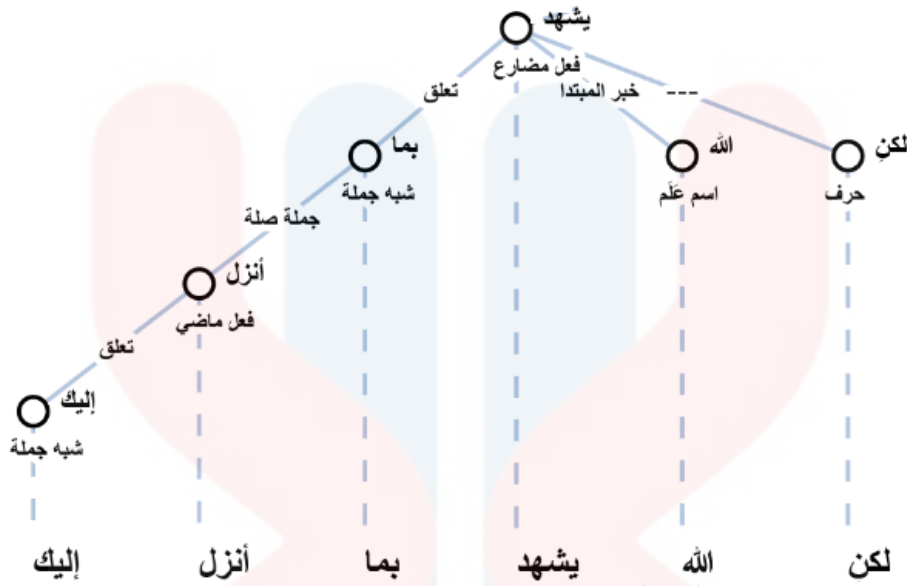

Figure 5: Examples of subordinate clauses (attachment clause "شبه جملة متعلق" – relative clause "جملة صلة")

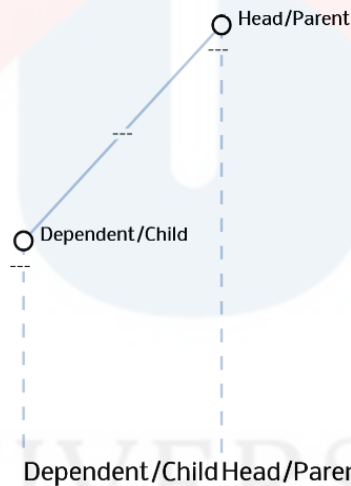

Figure 6: head-dependent attachment

Head-Dependent Attachment

Each syntactic relation has a head/parent, and a dependent/child. In the tree, the circle parts are called nodes, and they represent a token in the sentence. Each node has the token name next to it, as well as the node's POS tag. The relation between the two nodes is on the line that connects them.

In Arabic, there are two types of sentences; verbal sentence and nominal sentence. Verbal sentence consists of a verb, usually followed by a subject, object, and other modifiers. In these sentences, the verb is the sentence head, and the subject, object, and other modifiers are dependents. The Basic Nominal Sentence consists of a subject and a predicate. In these sentences, the predicate is the head of the subject, whether the sentence order is subject-predicate, or predicate-subject.

The Basic Nominal Sentence may be preceded by an incomplete verb (كان وأخواتها وكاد (وأخواتها ما - لا النافية للجنس ((إن وأخواتها), a verb-like particle (إن وأخواتها), or functional negation particles like (الحجازية). In such cases, the preceding verb or particle heads both the subject and the predicate.

Tokenization

Compared to English, Arabic has a rich and complex morphological system. Arabic base words inflect to eight features. Verbs inflect for aspect, mood, person and voice. Nouns and adjectives inflect for case, state, gender and number. Furthermore, inflected base words can attract various clitics. Clitical prefixes include determiners, particle proclitics, conjunctions and question particles in strict order. Clitical suffixes include pronominal modifiers. As a result of clitic attachment, morpho-syntactic interactions sometimes cause changes in spelling or pronunciations. Palmyra allows the user to fix the tokenization of the sentence, in terms of segmenting words correctly, normalizing them morpho-orthographically and correcting typographical errors

Segmentation

Affixes and clitics are marked with a “+” sign. The “+” signs are always attached to the affixes and clitics, and not the stem part of the word.

The following prefixes and proclitics are always segmented:

- Interrogative particle (أجئتم ← أ+ جئتم)
- Conjunctions (وقال ← و+ قال) - (فقال ← ف+ قال)
- Particles (كالحق ← ك+ الحق) - (بالله ← ب+ الله) - (لمدرسة ← ل+ مدرسة)
- Verbal modifier particles (ليكتب ← ل+ يكتب) - (سيكتب ← س+ يكتب)

The following suffixes and enclitics are always segmented:

- Pronominal enclitics (رأيتهم ← رأيت +ه) - (بيوتكم ← بيوت +كم) - (يسمعني ← يسمع +ني)
- Relative and interrogative pronouns (مما ← من +ما)

Normalization

Since decliticization can sometimes lead to malformed word forms, normalization is important for transforming the resulting tokens into their naturally uncliticized form. Words should be normalized to look the way it would if it didn't have any affixes/clitics attached to it. The following are some examples of this normalization:

- Alif-Lam (ال التعريف) : (للكتاب) (lktAb) 'for-the-book' → (l+ A lktAb) (not لكتاب)
- Ta-Marbuta (التاء المربوطة) : (مكتبتنا) (mktbtnA) 'our library' → (mktbñ +nA) (not مكتبتنا)
- Alif-Maqsura (ألف التانيث المقصورة) : (مستشفىهم) (mstšfAhm) 'their hospital' → (mstšfý +hm) (not مستشفىهم)
- word-final Hamza (الهمزة المتطرفة) : (بهاؤه / بهاءه / بهاؤه) (bhA'wñ / bhA'h / bhA'ÿh) 'his glory [nom./acc./gen.]' → (bhA' +h) (not بهاءه +ه)
- Waw of plurality (واو الجماعة) : (قالوا) (qAlwA) 'they-said-it' → (qAlwA +hA) (not قالواها)

Typographical Errors

Some types of typos that you may find are:

- Punctuation written using numbers or letters:
“.” instead of “.” (full stop)

“ز” instead of " , "(numeric commas)

- Punctuation that is not separated: "اليوم." ← "اليوم"
- Hamza variants (أ/إ/آ) as in (إلى ← إلى) - (الإسم ← الاسم)
- Ya/Alif Maqsura variants (ي - ي) as in (في ← في) - (إلى ← إلى) - (مستشفى ← مستشفى)
- Ta-Marbuta/ha' variants (ة/ه) as in (سيارة ← سيارة) - (لته ← له)
- Missing spaces:
 - Negation particles, as in (مازلنا ← مازلنا) - (لاسيما ← لا سيما)
 - Vocative particle, as in (يارجل ← يارجل)
 - Between words, as in (رئيسالجمهورية ← رئيس الجمهورية)
- Extra spaces where they do not belong: (رئيس الجمهورية ← رئيس الجمهورية)

CONCLUSION AND FUTURE WORK

The different approaches of teaching Arabic language unfortunately mainly focused on the accuracy of inflection, case ending, and the accuracy of the rules of Arabic syntax. Unfortunately, such tendency for teaching non-native speakers of Arabic is not practical enough or satisfactory without visualizing the syntactic relations between the head word and its dependents. Linking abstract rules with concrete head-modifier visualized relations makes the learning process to be more practical, and the syntactic rules to be easy in understanding and learning. So, in this paper, PALMYRA is described as a graphical tool for visualizing and editing Arabic syntactic trees. The design of PALMYRA 2.0 enables it to be configured to work with all syntactic constructions. It has been specifically designed to support rich-morphology languages (like Arabic) and to visualize the complexities of syntactic constructions. It also allows for editing linguistic features through simple drop-down menus and text fields. Being built entirely using standard web technologies, PALMYRA runs on all major web browsers.

In the future, we plan to use PALMYRA as a part of an experimental study of comparing the performance of two groups of students; one group studies the Arabic grammar in the traditional approach, and the other studies in PALMYRA practical approach.

REFERENCES

- Alena Böhmová, Jan Hajic, Eva Hajicová, and Barbora Hladká, 2003. The Prague Dependency Treebank, pages 103–127. Springer Netherlands, Dordrecht.
- Dima Taji and Nizar Habash. 2020. PALMYRA 2.0: A Configurable Multilingual Platform Independent Tool for Morphology and Syntax Annotation. In Proceedings of Universal Dependencies Workshop (UDW) 2020.
- Dukes, K., & Buckwalter, T. (2010, March). A dependency treebank of the Quran using traditional Arabic grammar. In *2010 the 7th International Conference on Informatics and Systems (INFOS)* (pp. 1-7). IEEE.
- Dukes, K., Atwell, E., & Sharaf, A. B. (2010, May). Syntactic annotation guidelines for the Quranic Arabic dependency treebank. In *Proceedings of the Seventh International Conference on Language Resources and Evaluation (LREC'10)*.
- Heinecke, J. (2019, August). ConlluEditor: a fully graphical editor for Universal dependencies treebank files. In *Proceedings of the Third Workshop on Universal Dependencies (UDW, SyntaxFest 2019)* (pp. 87-93).
- Javed, T., Habash, N., & Taji, D. (2018, May). Palmyra: A platform independent dependency annotation tool for morphologically rich languages. In *Proceedings of the Eleventh International Conference on Language Resources and Evaluation (LREC 2018)*.

- Jan Hajic, Otakar Smrž, Petr Zemánek, Jan Šnidauf, and Emanuel Beška. 2004. Prague Arabic Dependency ~ Treebank: Development in Data and Tools. In Proceedings of the International Conference on Arabic Language Resources and Tools, pages 110–117, Cairo, Egypt. ELDA.
- Joakim Nivre, Marie-Catherine de Marneffe, Filip Ginter, Yoav Goldberg, Jan Hajic, Christopher D. Manning, Ryan McDonald, Slav Petrov, Sampo Pyysalo, Natalia Silveira, Reut Tsarfaty, and Daniel Zeman. 2016. Universal dependencies v1: A multilingual treebank collection. In Proceedings of the Language Resources and Evaluation Conference (LREC), Portorož, Slovenia.
- Lamia Tounsi, Mohammed Attia, and Josef van Genabith. 2009. Automatic treebank-based acquisition of Arabic LFG dependency structures. In Proceedings of the EACL 2009 Workshop on Computational Approaches to Semitic Languages, pages 45–52, Athens, Greece.
- Little, A. and Tratz, S. (2016). Easytree: A graphical tool for dependency tree annotation. In Proceedings of the Tenth International Conference on Language Resources and Evaluation LREC 2016, Portorož, Slovenia, 2016.
- Mitchell P. Marcus, Beatrice Santorini, and Mary Ann Marcinkiewicz. 1993. Building a large annotated corpus of English: The Penn treebank. *Computational Linguistics*, 19(2):313–330.
- Mohamed Maamouri, Ann Bies, Hubert Jin, and Tim Buckwalter. 2003. Arabic treebank: Part 1 v 2.0. Linguistic Data Consortium (LDC2003T06).
- Najjar, M. (2020). Teaching Arabic Syntax for Non-Speakers: A Pragmatic Approach. *International Journal of Learning and Teaching*, 6, 252-256.
- Naiwen Xue, Fei Xia, Fu-Dong Chiou, and Marta Palmer. 2005. The Penn Chinese Treebank: Phrase structure annotation of a large corpus. *Natural Language Engineering*, 11(02):207–238.
- Nizar Habash and Ryan Roth. 2009. CATiB: The Columbia Arabic Treebank. In Proceedings of the Joint Conference of the Association for Computational Linguistics and the International Joint Conference on Natural Language Processing (ACL-IJCNLP), pages 221–224, Suntec, Singapore.
- N. Habash, R. Faraj and R. Roth. 2009. Syntactic Annotation in the Columbia Arabic Treebank. In Conference on Arabic Language Resources and Tools, Cairo, Egypt.
- Nizar Habash, Ryan Gabbard, Owen Rambow, Seth Kulick, and Mitch Marcus. 2007. Determining case in Arabic: Learning complex linguistic behavior requires complex linguistic features. In Proceedings of the 2007 Joint Conference on Empirical Methods in Natural Language Processing and Computational Natural Language Learning (EMNLP-CoNLL), pages 1084–1092.
- Nizar Habash and Owen Rambow. 2004. Extracting a Tree Adjoining Grammar from the Penn Arabic Treebank. In Proceedings of Traitement Automatique du Langage Naturel (TALN-04), pages 277–284. Fez, Morocco.
- Otakar Smrž, Viktor Bielický, Iveta Kouřilová, Jakub Krácmar, Jan Hajic, and Petr Zemánek. 2008. Prague arabic dependency treebank: A word on the million words. In Proceedings of the Workshop on Arabic and Local Languages (LREC 2008), pages 16–23, Marrakech, Morocco.
- O. Smrž and J. Hajic. 2006. The Other Arabic Treebank: ~ Prague Dependencies and Functions. In Ali Farghaly, editor, *Arabic Computational Linguistics*. CSLI Publications.
- Pajas, P. and Štěpánek, J. (2008). Recent advances in a feature-rich framework for treebank annotation. In Proceedings of the 22Nd International Conference on Computational Linguistics - Volume 1, COLING '08, pages 673–680, Stroudsburg, PA, USA. Association for Computational Linguistics.

- Salameh, M., Cherry, C., & Kondrak, G. (2013, June). Reversing morphological tokenization in English-to-Arabic SMT. In *Proceedings of the 2013 NAACL HLT Student Research Workshop* (pp. 47-53).
- Taji, D., Gizuli, J. E., & Habash, N. (2019). An Arabic dependency treebank in the travel domain. *arXiv preprint arXiv:1901.10188*.
- Zdenek Žabokrtský and Otakar Smrž. 2003. Arabic syntactic trees: from constituency to dependency. In *Proceedings of the Eleventh Conference of the European Chapter of the Association for Computational Linguistics (EACL'03) – Research Notes*, Budapest, Hungar.





PROCEEDINGS
INTERNATIONAL CONFERENCE ON UMMAH (ICU) 2022

e ISBN 978-967-0021-48-5



9 789670 021485

Penerbit : PENERBIT UMK

(ebook)